

## High Frequency Inductive Proximity Sensor

# E2EL

*Increased response frequency for high speed applications*

- Max 5 kHz, switching frequency
- M8 or dia
- 6.5 mm housing
- Brass or stainless steel housing



### Ordering Information

#### Cable types

##### Brass housing

Diameter	Length	Mounting	Sensing Distance	Output			
				NPN / NO	NPN / NC	PNP / NO	PNP / NC
Ø 6,5	30 mm	Shielded	1,5 mm	E2EL-C1R5E1 2M	E2EL-C1R5E2 2M	E2EL-C1R5F1 2M	E2EL-C1R5F2 2M
	32 mm	Non-shielded	2,0 mm	E2EL-C2ME1 2M	E2EL-C2ME2 2M	E2EL-C2MF1 2M	E2EL-C2MF2 2M
	45 mm	Shielded	1,5 mm	E2EL-C1R5E1-L 2M	E2EL-C1R5E2-L 2M	E2EL-C1R5F1-L 2M	E2EL-C1R5F2-L 2M
	47 mm	Non-shielded	2,0 mm	E2EL-C2ME1-L 2M	E2EL-C2ME2-L 2M	E2EL-C2MF1-L 2M	E2EL-C2MF2-L 2M
M8	30 mm	Shielded	1,5 mm	E2EL-X1R5E1 2M	E2EL-X1R5E2 2M	E2EL-X1R5F1 2M	E2EL-X1R5F2 2M
	32 mm	Non-shielded	2,0 mm	E2EL-X2ME1 2M	E2EL-X2ME2 2M	E2EL-X2MF1 2M	E2EL-X2MF2 2M
	45 mm	Shielded	1,5 mm	E2EL-X1R5E1-L 2M	E2EL-X1R5E2-L 2M	E2EL-X1R5F1-L 2M	E2EL-X1R5F2-L 2M
	47 mm	Non-shielded	2,0 mm	E2EL-X2ME1-L 2M	E2EL-X2ME2-L 2M	E2EL-X2MF1-L 2M	E2EL-X2MF2-L 2M

##### Stainless steel housing

Diameter	Length	Mounting	Sensing Distance	Output			
				NPN / NO	NPN / NC	PNP / NO	PNP / NC
Ø 6,5	30 mm	Shielded	2,0 mm	E2EL-C2E1-DS 2M	E2EL-C2E2-DS 2M	E2EL-C2F1-DS 2M	E2EL-C2F2-DS 2M
	45 mm	Shielded	2,0 mm	E2EL-C2E1-DSL 2M	E2EL-C2E2-DSL 2M	E2EL-C2F1-DSL 2M	E2EL-C2F2-DSL 2M
M8	30 mm	Shielded	2,0 mm	E2EL-X2E1-DS 2M	E2EL-X2E2-DS 2M	E2EL-X2F1-DS 2M	E2EL-X2F2-DS 2M
	45 mm	Shielded	2,0 mm	E2EL-X2E1-DSL 2M	E2EL-X2E2-DSL 2M	E2EL-X2F1-DSL 2M	E2EL-X2F2-DSL 2M

#### Plug types

##### Brass housing

Diameter	Length	Mounting	Sensing Distance	Output			
				NPN / NO	NPN / NC	PNP / NO	PNP / NC
Ø 6,5 / Plug M8	45 mm	Shielded	1,5 mm	E2EL-C1R5E1-M3	E2EL-C1R5E2-M3	E2EL-C1R5F1-M3	E2EL-C1R5F2-M3
	47 mm	Non-shielded	2,0 mm	E2EL-C2ME1-M3	E2EL-C2ME2-M3	E2EL-C2MF1-M3	E2EL-C2MF2-M3
	54 mm	Shielded	1,5 mm	E2EL-C1R5E1-M3L	E2EL-C1R5E2-M3L	E2EL-C1R5F1-M3L	E2EL-C1R5F2-M3L
	56 mm	Non-shielded	2,0 mm	E2EL-C2ME1-M3L	E2EL-C2ME2-M3L	E2EL-C2MF1-M3L	E2EL-C2MF2-M3L
M8 / Plug M8	45 mm	Shielded	1,5 mm	E2EL-X1R5E1-M3	E2EL-X1R5E2-M3	E2EL-X1R5F1-M3	E2EL-X1R5F2-M3
	47 mm	Non-shielded	2,0 mm	E2EL-X2ME1-M3	E2EL-X2ME2-M3	E2EL-X2MF1-M3	E2EL-X2MF2-M3
	54 mm	Shielded	1,5 mm	E2EL-X1R5E1-M3L	E2EL-X1R5E2-M3L	E2EL-X1R5F1-M3L	E2EL-X1R5F2-M3L
	56 mm	Non-shielded	2,0 mm	E2EL-X2ME1-M3L	E2EL-X2ME2-M3L	E2EL-X2MF1-M3L	E2EL-X2MF2-M3L
M8 / Plug M12	44 mm	Shielded	1,5 mm	E2EL-X1R5E1-M1	E2EL-X1R5E2-M1	E2EL-X1R5F1-M1	E2EL-X1R5F2-M1
	46 mm	Non-shielded	2,0 mm	E2EL-X2ME1-M1	E2EL-X2ME2-M1	E2EL-X2MF1-M1	E2EL-X2MF2-M1
	60 mm	Shielded	1,5 mm	E2EL-X1R5E1-M1L	E2EL-X1R5E2-M1L	E2EL-X1R5F1-M1L	E2EL-X1R5F2-M1L
	62 mm	Non-shielded	2,0 mm	E2EL-X2ME1-M1L	E2EL-X2ME2-M1L	E2EL-X2MF1-M1L	E2EL-X2MF2-M1L

## Specifications

### Brass type

Type	Ø 6,5		M8	
Operating voltage	10 to 35 VDC			
Rated supply voltage	24 VDC			
Current consumption	max. 15 mA at 24 VDC			
Sensing object	Ferrous metals			
Mounting ((s)hielded, (n)on-shielded) *1	s	n	s	n
Operating distance in mm	1,5	2,0	1,5	2,0
Tolerance of operating distance	±10%			
Standard target size in mm (L x W x H in mm, FE 37)	6,5x6,5x1		8x8x1	
Differential travel	1 % ... 15 % of operating distance			
Max. response frequency in kHz	5,0			
Control output	Type	E2EL-... E1 type: NPN-NO E2 type: NPN-NC F1 type: PNP-NO F2 type: PNP-NC		
	Max-Load	200 mA		
	Max-on-state Voltage drop	2,5 VDC (at 200mA load current and with 2 m cable)		
	Circuit protection	Reverse polarity, output short-circuit		
Indicator	Operating indicator (yellow LED)			
Ambient temperature	Operating: -25° to 70°C			
Humidity	35 to 95 % RH			
Influence of temperature	± 10 % max. of Sn at 23°C in temperature range of -25° to 70°C			
Dielectric strength	1.500 VAC, 50/60 Hz for 1 min. between current carry parts and case			
Electromagnetic compatibility EMC	EN 60947-5-2			
Vibration resistance	Destruction: 10 to 70 Hz, 1,5 mm double amplitude for 1 hour each in X, Y and Z directions			
Shock resistance	Destruction: 300 m/s <sup>2</sup> (approx. 30 G) for 6 times each in X, Y and Z directions			
Enclosure rating	IP 67 (EN 60947-1)			
Connection *2	Pre-wired	2 m PVC-cable, 3 x 0,14 mm <sup>2</sup>		
	Connector	M8 plug		
Weight in g	Pre-wired	long	45	50
		short	43	48
	Connector	long	10	15
		short	8	13
Material	Case	Brass		
	Sensing face	PBTP		

\*1. For detailed mounting instruction please refer to page D-105

\*2. PUR cable and different length on request.

## Stainless steel type

Type	Ø 6,5		M8	
Operating voltage	10 to 35 VDC			
Rated supply voltage	24 VDC			
Current consumption	max. 15 mA at 24 VDC			
Sensing object	Ferrous metals			
Mounting *1	shielded			
Operating distance in mm	2,0			
Tolerance of operating distance	±10%			
Standard target size in mm (L x W x H in mm, FE 37)	6,5x6,5x1	8x8x1		
Differential travel	1 % ... 15 % of operating distance			
Max. response frequency in kHz	4,0			
Control output	Type	E2EL-... E1 type: NPN-NO E2 type: NPN-NC F1 type: PNP-NO F2 type: PNP-NC		
	Max-Load	200 mA		
	Max-on-state Voltage drop	2,5 VDC (at 200mA load current and with 2 m cable)		
Circuit protection	Reverse polarity, output short-circuit			
Indicator	Operating indicator (yellow LED)			
Ambient temperature	Operating: -25° to 70°C			
Humidity	35 to 95 % RH			
Influence of temperature	± 10 % max. of Sn at 23°C in temperature range of -25° to 70°C			
Dielectric strength	1.500 VAC, 50/60 Hz for 1 min. between current carry parts and case			
Electromagnetic compatibility EMC	EN 60947-5-2			
Vibration resistance	Destruction: 10 to 70 Hz, 1,5 mm double amplitude for 1 hour each in X, Y and Z directions			
Shock resistance	Destruction: 300 m/s <sup>2</sup> (approx. 30 G) for 6 times each in X, Y and Z directions			
Enclosure rating	IP 67 (EN 60947-1)			
Connection *2	Pre-wired	2 m PVC-cable, 3 x 0,14 mm <sup>2</sup>		
	Connector	-	M8 plug	
Weight in g	Pre-wired	long	45	50
		short	43	48
	Connector	long	-	10
		short	-	-
Material	Case	stainless steel 1.4305 / AISI 303		
	Sensing face	PBTP		

\*1. For detailed mounting instruction please refer to page D-105

\*2. PUR cable and different length on request.

Engineering data

Standardized characteristic for lateral approach

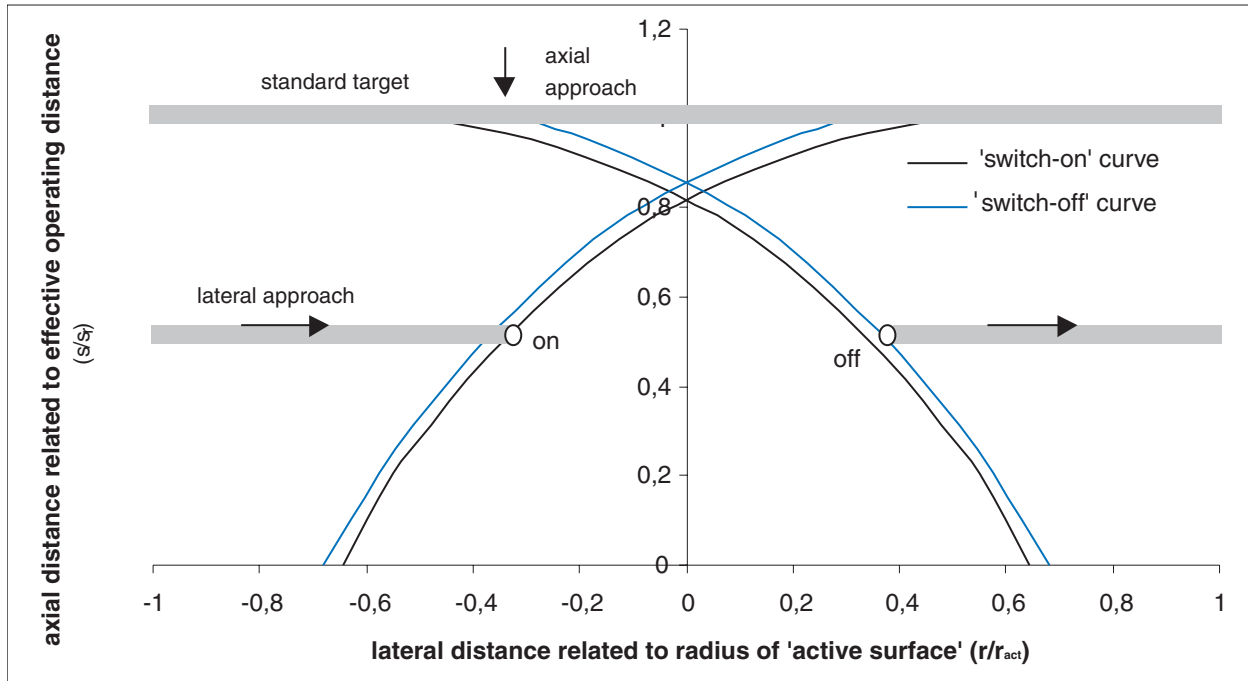

Output Circuit Diagram and Timing Chart

E2EL-□E□  
NPN Output

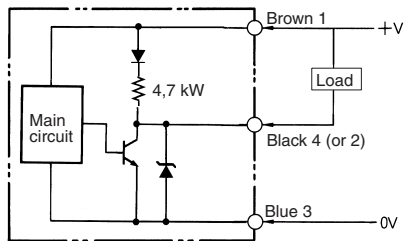

E2EL-□F□  
PNP Output

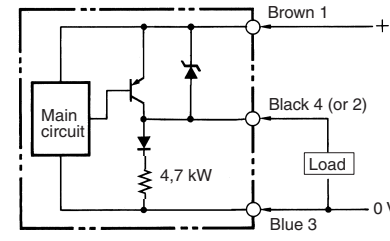

E2EL-□E□  
NPN Output

	NO	NC
Sensing object	Yes	No
Yellow indicator	Lit	Not lit
Control output	ON	OFF

E2EL-□F□  
PNP Output

	NO	NC
Sensing object	Yes	No
Yellow indicator	Lit	Not lit
Control output	ON	OFF

Pin Arrangement at Connector Types

1. Connector M8 (viewed to plug pins)

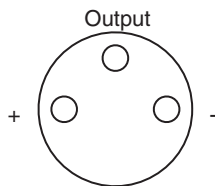

2. Connector M12 (viewed to plug pins)

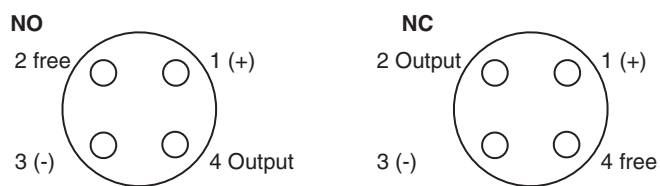

## Dimensions

### Cable types

**E2EL-C1□R5 2M, E2EL-C2□-DS 2M**

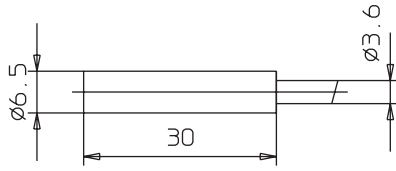

**E2EL-C2M□ 2M**

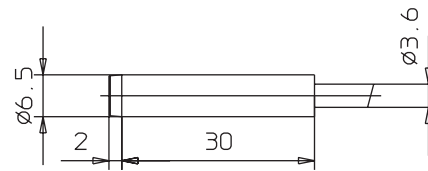

**E2EL-C1R5□-L 2M, E2EL-C2□-DSL 2M**

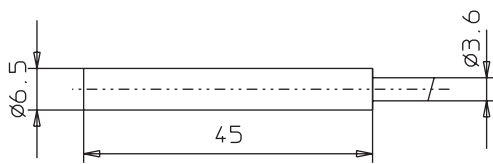

**E2EL-C2M□-L 2M**

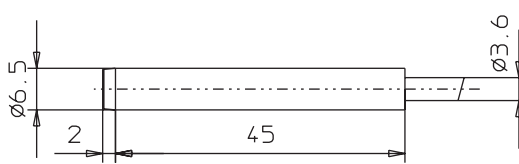

**E2EL-X1R5□ 2M, E2EL-X2□-DS 2M**

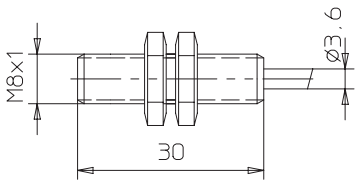

**E2EL-X2M□ 2M**

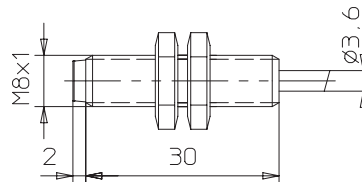

**E2EL-X1R5□-L 2M, E2EL-X2□-DSL 2M**

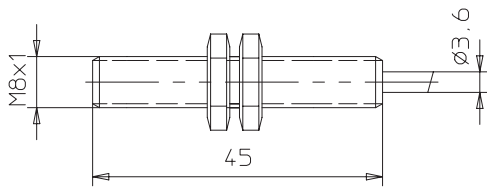

**E2EL-X2M□-L 2M**

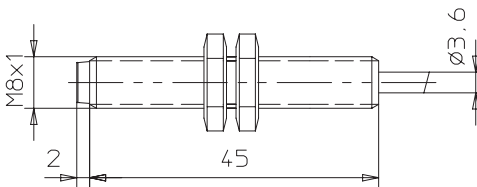

E2EL

Plug types

**E2EL-C1R5□-M3**

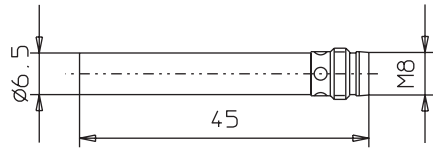

**E2EL-C2M□-M3**

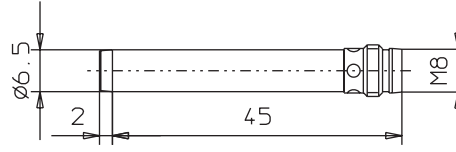

**E2EL-C1R5□-M3L**

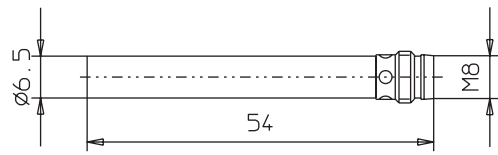

**E2EL-C2M□-M3L**

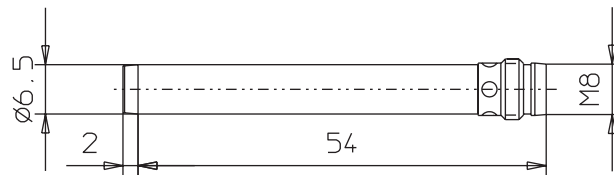

**E2EL-X1R5□-M3**

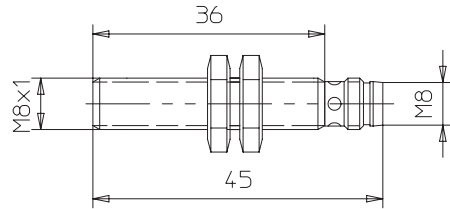

**E2EL-X2M□-M3**

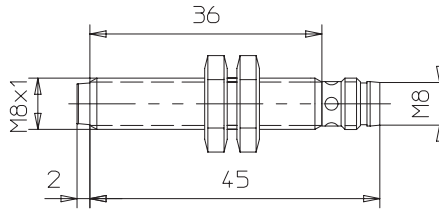

**E2EL-X1R5□-M3L, E2EL-X2□-DM3S**

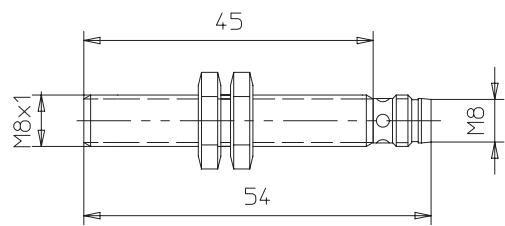

**E2EL-X2M□-M3L**

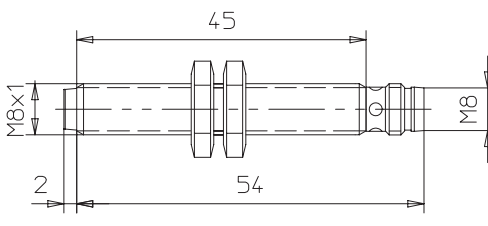

**E2EL-X1R5□-M1**

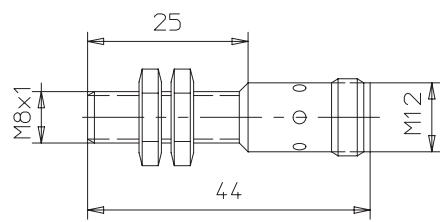

**E2EL-X2M□-M1**

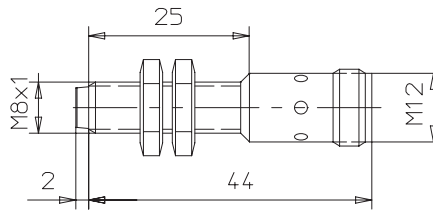

**E2EL-X1R5□-M1L**

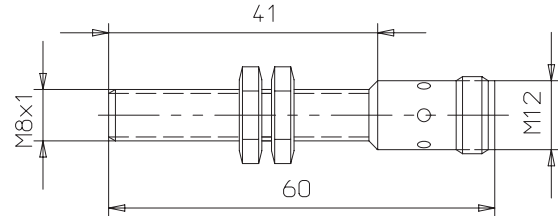

**E2EL-X2M□-M1L**

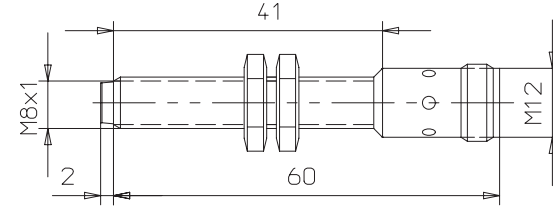

## Installation

### Caution

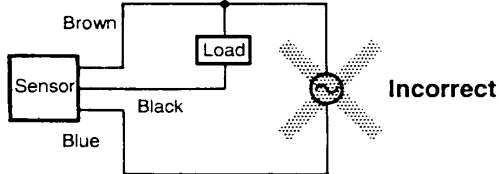
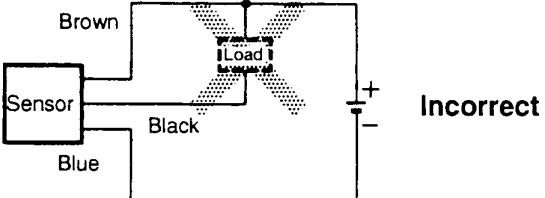
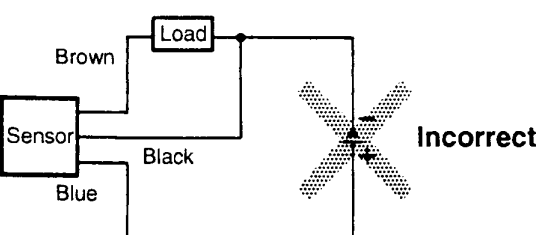
Item	Examples
<p><b>Power Supply</b> Do not impose an excessive voltage on the E2EL, otherwise it may explode or burn. Do not impose 24 VAC on any E2EL model, otherwise it may explode or burn.</p>	
<p><b>Load short-circuit</b> Do not short-circuit the load, or the E2EL may explode or burn. The E2EL's short-circuit protection function is valid, if the polarity of the supply voltage imposed is incorrect and within the rated voltage range.</p>	
<p><b>Wiring</b> Be sure to wire the E2EL and load correctly, otherwise it may explode or burn.</p>	

### Correct Use

#### Installation

##### Power Reset Time

The Proximity Sensor is ready to operate within 100 ms after power is supplied. If power supplies are connected to the Proximity Sensor and load respectively, be sure to supply power to the Proximity Sensor before supplying power to the load.

##### Power OFF

The Proximity Sensor may output a pulse signal when it is turned off. Therefore, it is recommended to turn off the load before turning off the Proximity Sensor.

##### Power Supply Transformer

When using a DC power supply, make sure that the DC power supply has an insulated transformer. Do not use a DC power supply with an auto-transformer.

##### Sensing Object

###### Metal Coating:

The sensing distance of the Proximity Sensor vary with the metal coating on sensing objects.

#### Wiring

##### High-tension Lines

##### Wiring through Metal Conduit

If there is a power or high-tension line near the cord of the Proximity Sensor, wire the cord through an independent metal conduit to prevent against Proximity Sensor damage or malfunctioning.

##### Core Tractive Force

Do not pull cords with the tractive force exceeding the following:  
pull force (N) = 20 x cable diameter ( mm)

##### Mounting

The Proximity Sensor must not be subjected to excessive shock with a hammer when it is installed, otherwise the Proximity Sensor may be damaged or lose the water-resistivity.

#### Environment

##### Water-Resistivity

Do not use the Proximity Sensor underwater, outdoors or in the rain.

##### Operating Environment

Be sure to use the Proximity Sensor within operating ambient temperature range and do not use the Proximity Sensor outdoors so that its reliability and life expectancy can be maintained. Although the Proximity Sensor is water resistive, a cover to protect the Proximity Sensor from water or soluble machining oil is recommended so that its reliability and life expectancy can be maintained. Do not use the Proximity Sensor in an environment with chemical gas (e. G., strong alkaline or acid gases including nitric, chromic, and concentrated sulfuric acid gases).

Item	Examples	Item
AND (serial connection)	<p style="text-align: center;"><b>Correct</b></p>	<p>The Sensors connected together must satisfy the following conditions:</p> <p><math>iL + (N-1) \times i =</math> Upper-limit of control output of each Sensor</p> <p><math>VS - N \times VR =</math> Load operating voltage</p> <p><math>N =</math> No. of Sensors</p> <p><math>VR =</math> Residual voltage of each Sensor</p> <p><math>VS =</math> Supply voltage</p> <p><math>i =</math> Current consumption of the Sensor</p> <p><math>iL =</math> Load current</p> <p>If the MY Relay, which operate at 24 VDC, is used as a load for example, a maximum of two Proximity Sensors can be connected to the load.</p>
OR (parallel connection)	<p style="text-align: center;"><b>Correct</b></p>	<p>The number of Sensors connected in parallel varies with the Proximity Sensor model.</p>

**Effects of Surrounding Metal**

**Shielded types:**

Shielded allow direct installation on metal plates in an embedded manner without performance change. A minimum distance of 3sn is required between the active surface and a metallic surface in front of the device. (Fig. 1).

For SUS shielded types the following minimum distances are required to avoid performance change (see Fig.2 and table below):

Shielded SUS Types	Free zone
E2EL-2□-DS	0,5 mm

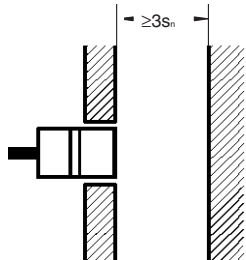

Fig.1: Shielded type (except SUS)

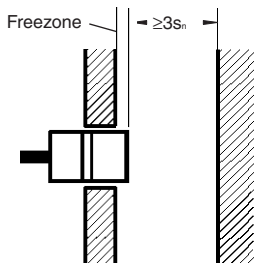

Fig.2: Shielded SUS type

**Non-shielded types:**

Installation of non-shielded types in metal require the minimum distances according to Fig. 3.

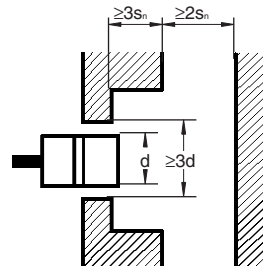

Fig.3: Non-shielded type

ALL DIMENSIONS SHOWN ARE IN MILLIMETERS.  
 To convert millimeters into inches, multiply by 0.03937. To convert grams into ounces, multiply by 0.03527.



## X-ON Electronics

Largest Supplier of Electrical and Electronic Components

*Click to view similar products for [Proximity Sensors](#) category:*

*Click to view products by [Omron](#) manufacturer:*

Other Similar products are found below :

[01.001.5653.1](#) [70.340.1028.0](#) [70.360.2428.0](#) [70.364.4828.0](#) [70.810.1053.0](#) [72.360.1628.0](#) [73.363.6428.0](#) [8027AL20NL2CPXX](#) [FYCC8E1-2](#)  
[9221350022](#) [922AA2W-A9P-L](#) [PLS2](#) [GL-12F-C2.5X10\(LOT3\)](#) [972AB2XM-A3N-L](#) [972AB3XM-A3P-L](#) [PS3251](#) [980659-1](#) [QT-12](#) [E2E2-](#)  
[X5M41-M4](#) [E2E-X14MD1-G](#) [E2E-X2D1-G](#) [E2EX2ME2N](#) [E2EX3D1SM1N](#) [E2E-X4MD1-G](#) [E2E-X5E1-5M-N](#) [E2E-X5Y2-N](#) [E2E-X7D1-](#)  
[M1J-T-0.3M-N](#) [E2FMX1R5D12M](#) [E2K-F10MC1](#) [5M](#) [EH-302](#) [EI3010TBOP](#) [EI5515NPAP](#) [MS605AU](#) [EP175-32000](#) [IFRM04N35B1/L](#)  
[IFRM04P1513/S35L](#) [IFRM06P1703/S35L](#) [IFRM08P1501/S35L](#) [IFRM12N17G3/L](#) [IFRM12P17G3/L](#) [IFRM12P3502/L](#) [IFRM12P37G1/S14L](#)  
[ILFK12E9189/I02](#) [ILFK12E9193/I02](#) [IMM2582C](#) [OISN-013](#) [25.161.3253.0](#) [25.332.0653.1](#) [25.352.0653.0](#) [25.352.0753.0](#)