

# Rectangular Proximity Sensor E2Q6

CSM\_E2Q6\_DS\_E\_1\_1

## Freely Change the Sensing Direction

- Change between any of five sensing directions: front or 90° up, down, left, or right.
- Four indicators show the operating status of the Sensor from many directions.





**⚠** Refer to *Safety Precautions* on page 4.

For the most recent information on models that have been certified for safety standards, refer to your OMRON website.

## Ordering Information

### Sensors [Refer to *Dimensions* on page 6]

#### DC Models

Shielded/ Unshielded	Sensing distance	Connection method	Operation mode	Model	
				NPN output	PNP output
Shielded 	20 mm	Terminal block	NO + NC	E2Q6-N20E3-H	E2Q6-N20F3-H
Unshielded 	30 mm			E2Q6-N30ME3-H	E2Q6-N30MF3-H

## Accessories (Sold Separately)

### Recommended Cable Gland (ST Type) (Manufactured by LAPP)

Purchase a cable gland to maintain a water-resistant structure.

Product number	Color	Screw size	Applicable cable outer diameter
ST-M20 × 1.5	Black	M20 × P1.5	7 to 13 dia.

#### Dimensions (Unit: mm)

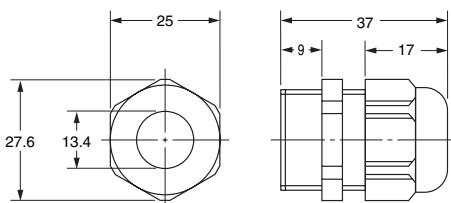

For details or to make purchases, contact your OMRON sales representative.

**Note:** A seal packing is not included.

#### Applicable seal packing

GPM20

**Note:** Purchase a seal packing to maintain water resistance.

## Ratings and Specifications

Item	Shielding	Shielded	Unshielded
	Model	E2Q6-N20□3-H	E2Q6-N30M□3-H
Sensing distance		20 mm ±10%	30 mm ±10%
Set distance		0 to 16 mm	0 to 24 mm
Differential travel		15% max. of sensing distance	
Detectable object		Ferrous metal (The sensing distance decreases with non-ferrous metal. Refer to <i>Engineering Data (Reference Value)</i> on page 3.)	
Standard sensing object		Iron, 60 × 60 × 1 mm	Iron, 90 × 90 × 1 mm
Response frequency *1		150 Hz	100 Hz
Power supply voltage (operating voltage range)		10 to 30 VDC, including 10% ripple (p-p)	
Current consumption		20 mA max.	
Control output	Load current	200 mA max.	
	Residual voltage	2 V max. (at 200 mA load current)	
Indicators		Power indicator (green), detection indicator (yellow)	
Operation mode		NO + NC	
Protection circuits		Power supply reverse polarity protection, output reverse polarity protection, and load short-circuit protection	
Ambient temperature range		Operating and storage: -25 to 70°C (with no icing or condensation)	
Ambient humidity range		Operating and storage: 35% to 95% (with no condensation)	
Temperature influence		±15% max. of sensing distance at 23°C in the temperature range of -25 to 70°C	
Voltage influence		±2% max. of sensing distance at 24 VDC in the range of 24 VDC ±15% ±2% max. of sensing distance at 12 VDC in the range of 12 VDC ±15%	
Insulation resistance		50 MΩ min. (at 500 VDC) between current-carrying parts and case	
Dielectric strength		1,000 VAC, at 50/60 Hz for 1 min. between current-carrying parts and case	
Vibration resistance (destruction)		10 to 55 Hz with a 1.5-mm double amplitude in X, Y, and Z directions	
Shock resistance (destruction)		300 m/s <sup>2</sup> 3 times each in six directions	
Degree of protection		IEC IP67 *2	
Connection method		Terminal block	
Weight (packed state/Sensor only)		Approx. 250 g/approx. 230 g	
Materials	Case	Polyamide (PA)	
	Sensing surface	Polyamide (PA)	
	Terminal base	Polyamide (PA)	
Accessories		Instruction manual	

\*1. The response frequency is an average value. Measurement conditions are as follows: standard sensing object, a distance of twice the standard sensing object, and a set distance of half the sensing distance.

\*2. When the recommended cable gland is used.

# Engineering Data (Reference Value)

## Sensing Area

**Shielded Models**  
E2Q6-N20□3-H

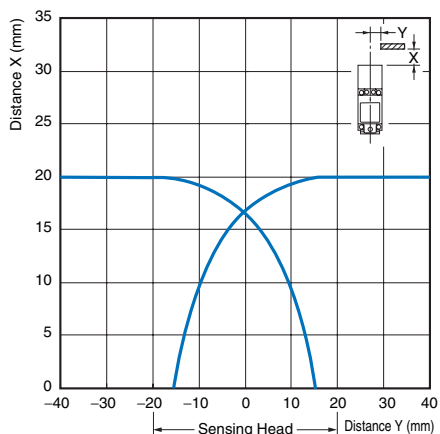

**Unshielded Models**  
E2Q6-N30M□3-H

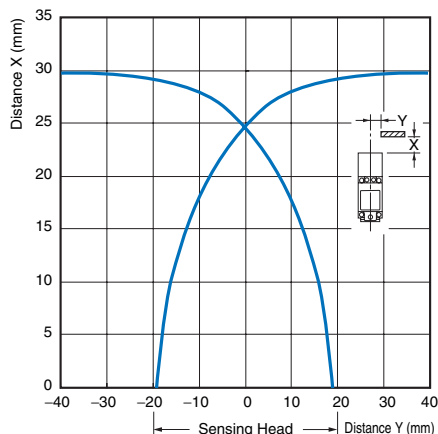

## Influence of Sensing Object Size and Materials

**Shielded Models**  
E2Q6-N20□3-H

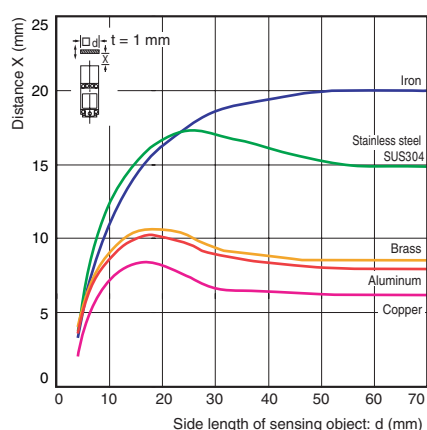

**Unshielded Models**  
E2Q6-N30M□3-H

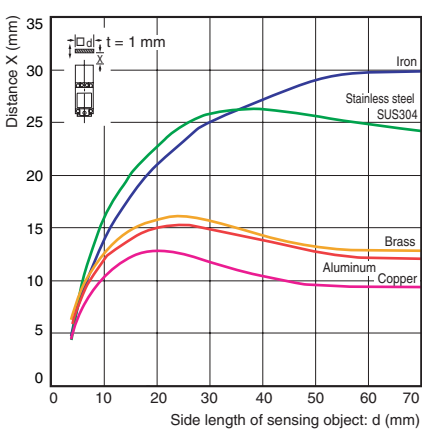

## I/O Circuit Diagrams

### NPN

Model	Operation mode	Timing charts	Output circuit
E2Q6-N20E3-H E2Q6-N30ME3-H	NO + NC		

### PNP

Model	Operation mode	Timing charts	Output circuit
E2Q6-N20F3-H E2Q6-N30MF3-H	NO + NC		

## Safety Precautions

Be sure to read the precautions for all models in the website at: <http://www.ia.omron.com/>.

### Indication and Meaning for Safe Use

 <b>WARNING</b>	Indicates a potentially hazardous situation which, if not avoided, will result in minor or moderate injury, or may result in serious injury or death. Additionally there may be significant property damage.
<b>Precautions for Safe Use</b>	Supplementary comments on what to do or avoid doing, to use the product safely.
<b>Precautions for Correct Use</b>	Supplementary comments on what to do or avoid doing, to prevent failure to operate, or undesirable effect on product performance.

### **WARNING**

**This product is not designed or rated for directly or indirectly ensuring safety of persons. Do not use it for such a purpose.**



**Never use this product with an AC power supply. Otherwise, explosion may result.**



### Precautions for Safe Use

The following precautions must be observed to ensure safe operation.

- Do not use the product in an environment where flammable or explosive gas is present.
- Do not attempt to disassemble, repair, or modify the product.
- Power Supply Voltage**  
Do not use a voltage that exceeds the rated operating voltage range. Applying a voltage that is higher than the operating voltage range may result in damage or burnout.
- Incorrect Wiring**  
Be sure that the power supply polarity and other wiring is correct. Incorrect wiring may cause explosion or burnout.
- Connection without a Load**  
If the power supply is connected directly without a load, the internal elements may explode or burn. Be sure to insert a load when connecting the power supply.
- Dispose of this product as industrial waste.

### UL Certification

This product is certified for UL standards, but the certification is not applicable to metal piping to the conduit section. For UL applications, use a certified cable grip.

### Precautions for Correct Use

#### Operating Environment

- Do not install the product in the following locations. Doing so may result in product failure or malfunction.
  - Outdoor locations directly subject to sunlight, rain, snow, water droplets, or oil.
  - Locations subject to atmospheres with chemical vapors, in particular solvents and acids.
  - Locations subject to corrosive gases.
  - Locations subject to shocks or vibration.
- The Sensor may malfunction if used near ultrasonic cleaning equipment, high-frequency equipment, transceivers, cellular phones, inverters, or other devices that generate a high-frequency electric field. Please refer to the Precautions for Correct Use of Photoelectric Sensors on the OMRON website ([www.ia.omron.com](http://www.ia.omron.com)) for typical measures.
- Laying the Proximity Sensor wiring in the same conduit or duct as high-voltage wires or power lines may result in incorrect operation and damage due to induction. Wire the Sensor using a separate conduit or independent conduit.
- Cleaning**  
Never use thinner or other solvents. Otherwise, the product surface may be dissolved.
- Do not subject the Sensor to strong shock. Otherwise, the Sensor Head may be damaged.

#### Power ON

The Sensor is ready to sense an object within 300 ms after turning the power ON. If the load and Sensor are connected to different power supplies, always turn ON the Sensor power first.

#### Power OFF

Output pulses may occur when the power supply is turned OFF. Turn OFF the power supply to the load or load line first.

#### Effects of Surrounding Metals

When the Proximity Sensor is embedded in metal, make sure that the clearances given in the following table are maintained.

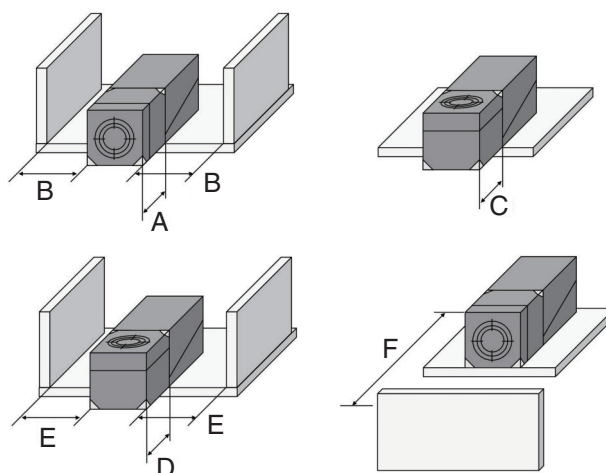

(Unit: mm)

Model	A	B	C	D	E	F
E2Q6-N20□3-H	0	0	0	0	10	60
E2Q6-N30M□3-H	40	0	25	40	20	90

## Mutual Interference

If more than one Proximity Sensor is installed face-to-face or side-by-side, make sure that the distances between two units adjacent to each other are the same as or larger than the corresponding values shown in the following table.

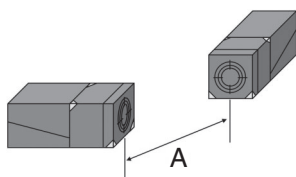
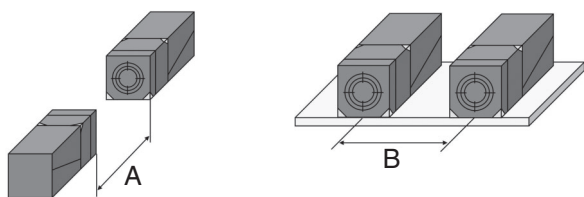

(Unit: mm)

Model	A	B
E2Q6-N20□3-H	170	120
E2Q6-N30M□3-H	280	200

## Tightening Torque

Tighten bolts and screws with the specified torque.

Between case and terminal	1.8 N·m
Terminal screws	1.0 N·m

## Switching the Sensing Direction

1. Remove two screws.



2. Lifting the sensing surface separates it from the case.

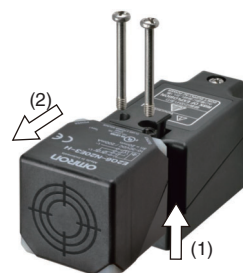

3. When positioning the sensing surface to the side, rotate it to the required position, then fit it into the case. (The possible positions are 0, 90, 180, and 270°. Do not forcefully rotate the sensing surface.)



4. Secure it with the screws.



# Dimensions

Tolerance class IT16 applies to dimensions in this data sheet unless otherwise specified.

## Sensors

- E2Q6-N20E3-H
- E2Q6-N20F3-H
- E2Q6-N30ME3-H
- E2Q6-N30MF3-H

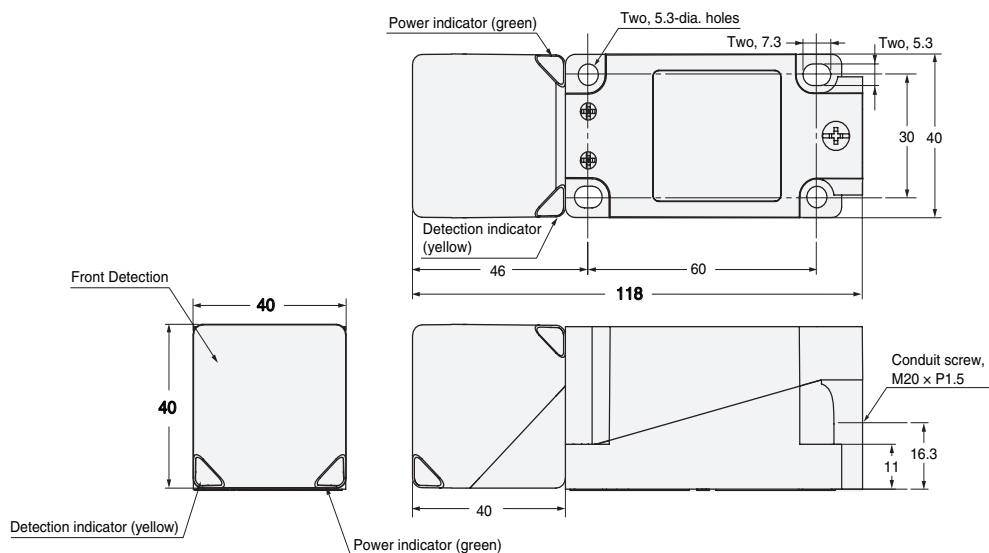

### Mounting Hole Dimensions

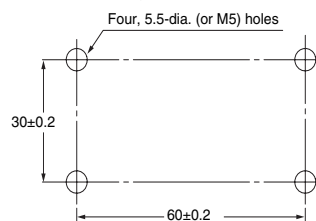

## Terms and Conditions Agreement

### Read and understand this catalog.

Please read and understand this catalog before purchasing the products. Please consult your OMRON representative if you have any questions or comments.

### Warranties.

(a) Exclusive Warranty. Omron's exclusive warranty is that the Products will be free from defects in materials and workmanship for a period of twelve months from the date of sale by Omron (or such other period expressed in writing by Omron). Omron disclaims all other warranties, express or implied.

(b) Limitations. OMRON MAKES NO WARRANTY OR REPRESENTATION, EXPRESS OR IMPLIED, ABOUT NON-INFRINGEMENT, MERCHANTABILITY OR FITNESS FOR A PARTICULAR PURPOSE OF THE PRODUCTS. BUYER ACKNOWLEDGES THAT IT ALONE HAS DETERMINED THAT THE PRODUCTS WILL SUITABLY MEET THE REQUIREMENTS OF THEIR INTENDED USE.

Omron further disclaims all warranties and responsibility of any type for claims or expenses based on infringement by the Products or otherwise of any intellectual property right. (c) Buyer Remedy. Omron's sole obligation hereunder shall be, at Omron's election, to (i) replace (in the form originally shipped with Buyer responsible for labor charges for removal or replacement thereof) the non-complying Product, (ii) repair the non-complying Product, or (iii) repay or credit Buyer an amount equal to the purchase price of the non-complying Product; provided that in no event shall Omron be responsible for warranty, repair, indemnity or any other claims or expenses regarding the Products unless Omron's analysis confirms that the Products were properly handled, stored, installed and maintained and not subject to contamination, abuse, misuse or inappropriate modification. Return of any Products by Buyer must be approved in writing by Omron before shipment. Omron Companies shall not be liable for the suitability or unsuitability or the results from the use of Products in combination with any electrical or electronic components, circuits, system assemblies or any other materials or substances or environments. Any advice, recommendations or information given orally or in writing, are not to be construed as an amendment or addition to the above warranty.

See <http://www.omron.com/global/> or contact your Omron representative for published information.

### Limitation on Liability; Etc.

OMRON COMPANIES SHALL NOT BE LIABLE FOR SPECIAL, INDIRECT, INCIDENTAL, OR CONSEQUENTIAL DAMAGES, LOSS OF PROFITS OR PRODUCTION OR COMMERCIAL LOSS IN ANY WAY CONNECTED WITH THE PRODUCTS, WHETHER SUCH CLAIM IS BASED IN CONTRACT, WARRANTY, NEGLIGENCE OR STRICT LIABILITY.

Further, in no event shall liability of Omron Companies exceed the individual price of the Product on which liability is asserted.

### Suitability of Use.

Omron Companies shall not be responsible for conformity with any standards, codes or regulations which apply to the combination of the Product in the Buyer's application or use of the Product. At Buyer's request, Omron will provide applicable third party certification documents identifying ratings and limitations of use which apply to the Product. This information by itself is not sufficient for a complete determination of the suitability of the Product in combination with the end product, machine, system, or other application or use. Buyer shall be solely responsible for determining appropriateness of the particular Product with respect to Buyer's application, product or system. Buyer shall take application responsibility in all cases.

NEVER USE THE PRODUCT FOR AN APPLICATION INVOLVING SERIOUS RISK TO LIFE OR PROPERTY OR IN LARGE QUANTITIES WITHOUT ENSURING THAT THE SYSTEM AS A WHOLE HAS BEEN DESIGNED TO ADDRESS THE RISKS, AND THAT THE OMRON PRODUCT(S) IS PROPERLY RATED AND INSTALLED FOR THE INTENDED USE WITHIN THE OVERALL EQUIPMENT OR SYSTEM.

### Programmable Products.

Omron Companies shall not be responsible for the user's programming of a programmable Product, or any consequence thereof.

### Performance Data.

Data presented in Omron Company websites, catalogs and other materials is provided as a guide for the user in determining suitability and does not constitute a warranty. It may represent the result of Omron's test conditions, and the user must correlate it to actual application requirements. Actual performance is subject to the Omron's Warranty and Limitations of Liability.

### Change in Specifications.

Product specifications and accessories may be changed at any time based on improvements and other reasons. It is our practice to change part numbers when published ratings or features are changed, or when significant construction changes are made. However, some specifications of the Product may be changed without any notice. When in doubt, special part numbers may be assigned to fix or establish key specifications for your application. Please consult with your Omron's representative at any time to confirm actual specifications of purchased Product.

### Errors and Omissions.

Information presented by Omron Companies has been checked and is believed to be accurate; however, no responsibility is assumed for clerical, typographical or proofreading errors or omissions.

## X-ON Electronics

Largest Supplier of Electrical and Electronic Components

*Click to view similar products for [Omron](#) manufacturer:*

Other Similar products are found below :

[G9ED-1-B-AQ-DC24](#) [E3X-SD11 2M](#) [S8VM-10024C](#) [R88A-CCW002P2](#) [S82Y-VM30D](#) [H3AM-NS-A AC100-240](#) [G3NA-440B-2 DC5-24](#)  
[XF2J-0824-11A-R100](#) [G3NA-425B-2 DC5-24](#) [MY2N-DC24](#) [XF2J-0824-12A](#) [G8JN-1C7T-R-DC12](#) [G8VA-1A4T-R01-DC12](#) [G8HE-1A7T-](#)  
[R-DC12](#) [XF2W-2415-1A](#) [XF2U-3015-3A](#) [G8V-RH-1A7T-R-DC12](#) [LY1D-2-5S-AC120](#) [M165-JR-24D](#) [M16-TG-24D](#) [CS1G-CPU43-E](#)  
[M22CAT1](#) [61F-GP-NT AC110](#) [M7E-01DGN2-B](#) [M7E-02DGN2](#) [M7E-08DRN2](#) [M7E-20DRN1](#) [M7E-HRN2](#) [M8PHWS](#) [D2HW-BL211DL](#)  
[D2VW-5L2A-2MS](#) [F03-02 SUS316](#) [F150LTC20](#) [F3SJ-A0245P30](#) [F3STGRNSMC21M1J8](#) [F3UVHM](#) [MG2-US-AC24](#) [MGN1C-DC24](#)  
[MK2EP-UA-AC6V](#) [MK2PNIAC240](#) [MK310E-DC24](#) [MKS2XTIN-11 DC110](#) [MM4KPAC120NC](#) [MM4XPAC120](#) [G2Q-184P-V-DC5](#) [G2R-](#)  
[1114P-V-US-DC5](#) [G2R13SNDDC24](#) [G2R-1-T 5VDC](#) [G2R-2 240VAC](#) [G2R-2 48VAC](#)