

A Water-resistant Amplifier with a Green Light Source Ideal for Label and Packaging Industries

- The E3X-NVG uses a green light source to detect colors that cannot be detected using sensors with red light sources
- The E3X-NV incorporates a red light source
- Teach function with No-Object Teaching capability speeds setup
- Rated IP66: can withstand light washdown
- Remote teach function allows easy remote teaching from the controller
- Mounts on DIN rail track
- Uses E32-series fiber-optic cables (Refer to the E32 fiber-optic data sheet.)



Ordering Information

■ AMPLIFIER UNITS

Light source	Appearance	Connections	Output	Part number
Green LED		Pre-leaded	NPN open collector	E3X-NVG21
Red LED				E3X-NV21

■ REPLACEMENT PART

Description	Part number
Mounting bracket supplied with sensor	E39-L48

Specifications

■ RATINGS/CHARACTERISTICS

Amplifier

Part number		E3X-NV21	E3X-NVG21
Supply voltage		12 to 24 VDC \pm 10%, ripple (p-p) 10% max.	
Current consumption		50 mA max.	
Light source (wavelength)		Red LED (680 nm)	Green LED (565 nm)
Required fiber-optic cables		For compatibility, see "DIN-rail Amplifiers" in the E32 fiber-optic data sheet.	
Control output		NPN open collector, load current: 100 mA; residual voltage 1 V max.	
Operation mode		Light-ON/Dark-ON, switch selectable	
Circuit protection		Reverse polarity, output short-circuit	
Response time		500 μ s max. at rated detection distance	
Sensitivity setting		Automatically set during Teaching function	
Timer function		OFF-delay timer (fixed at 40 ms); timer function can be disabled by switch setting	
Indicators	Orange LED	Lit during output operation	
	Green LED	Lit with stable light reception or no light	
Teaching function	Remote input	Remote input is ON when pink and blue wires short-circuited Remote input is OFF when pink and blue wires are not shorted	
	Confirmation	Red/green LED indicators and buzzer	
Enclosure rating		IEC IP66 with protective cover in place IEC IP65 with amplifier is connected to a fine fiber sensor, a heat-resistant sensor (E32-T61, E32-D61 or E32-D73), an armored sensor, and E32-M21. IP50 without the protective cover	
Connections	Pre-leaded	2 m (6.56 ft) cable	
Weight		Approx. 100 g	
Material	Case	Heat-resistant ABS	
	Cover	Polycarbonate	
Ambient illumination	Sunlight	10,000 lx max.	
	Incandescent lamp	3,000 lx max.	
Ambient operating temperature		-25°C to 55°C (-13°F to 131°F) with no icing	
Relative humidity		35% to 85% with no condensation	
Insulation resistance		20 MW min. at 500 VDC	
Dielectric strength		1,000 VAC, 50/60 Hz for 1 min	
Vibration resistance		10 to 55 Hz, 1.5-mm double amplitude or 300 m/s ² (approx. 30 G) for 2 hrs each in X, Y, and Z axes	
Shock resistance		500 m/s ² (approx. 50G) for 3 times each in X, Y, and Z axes	

■ LIGHT SOURCE COLOR SELECTION

To distinguish two colors, select a light source color that creates a large difference in the reflection rate between the two colors.

Reflection Rates

Refer to the following table to select the best light source color to distinguish colors.

Colors to be distinguished	Light source	
	Red	Green
White – Red		Yes
White – Green	Yes	
Red – Green	Yes	
Black – Red	Yes	
Black – Green		Yes
White – Black	Yes	Yes

Red Light Source (E3X-NV)

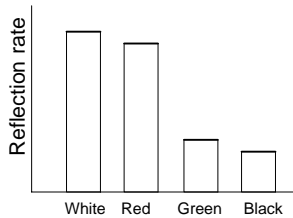

Green Light Source (E3X-NVG)

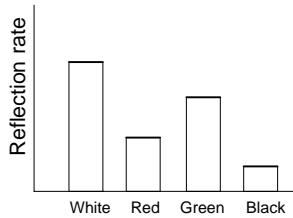

Operation

■ OUTPUT CIRCUITS

E3X-NV21/NVG21

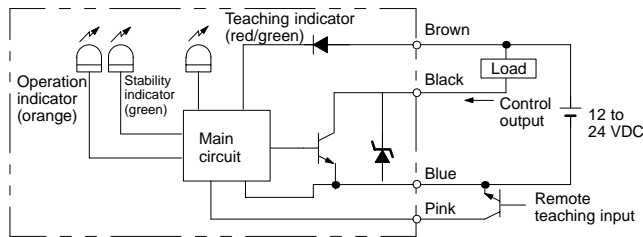

Timing Chart

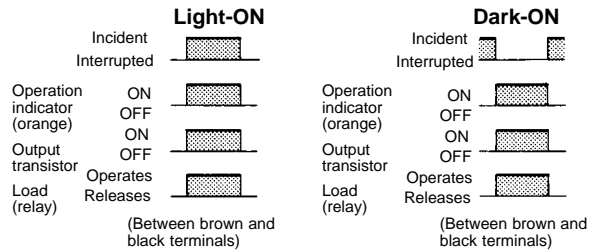

■ WITH/WITHOUT-OBJECT TEACHING, NO-OBJECT TEACHING, MAXIMUM SENSITIVITY SETTING

Refer to the following table to select the most suitable sensitivity setting method.

Sensitivity setting method	Maximum sensitivity setting	No-object teaching	With/Without-object teaching
Typical application	Detection of the existence of objects that interrupt light perfectly Detection of objects with no background objects	If teaching is impossible by stopping the movement of detectable objects	Detection of a slight difference in reflection Color discrimination
		To detect bright or dark objects by teaching only with background objects	Background objects with unstable reflection Detection of object surface irregularities
		Elimination of background object influence	

Note: If the set distance is very short (i.e., 0 to 12 mm for the E32-TC200 and 0 to 4 mm for the E32-DC200), no-object teaching is not possible due to excessive light. In this case, perform with/without-object teaching.

■ NO-OBJECT TEACHING WITH AN INITIAL OPERATING LEVEL COMPENSATION FUNCTION

With Diffuse (Light-ON) Fiber

1. Teaching button is pressed once.

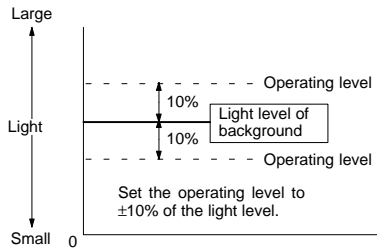

Change to
RUN mode

2. The first detectable object is in the detectable area.

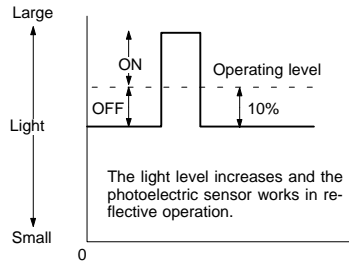

3. Detectable objects continue to pass through the sensing area.

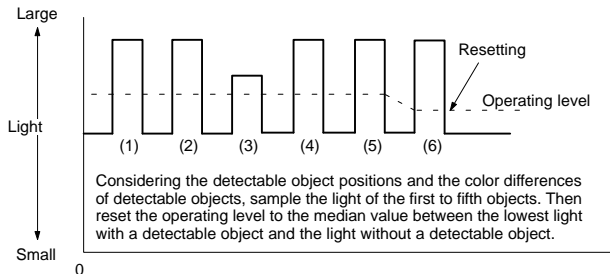

Note: If the light value up to the fifth object is at least twice as large as the operating level, the initial set operating level (10%) will be maintained.

With Through-beam (Dark-ON) Fiber Unit

1. Teaching button is pressed once.

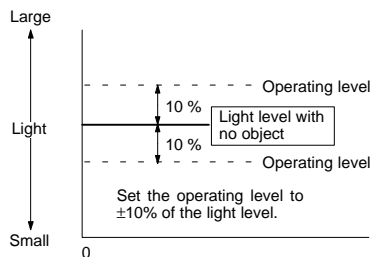

Change to
RUN mode

2. The first detectable object is in the sensing area.

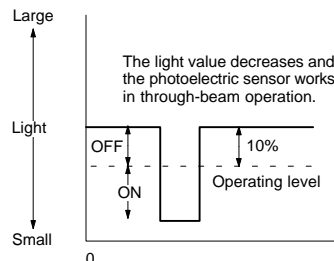

3. Detectable objects continue to pass through the sensing area.

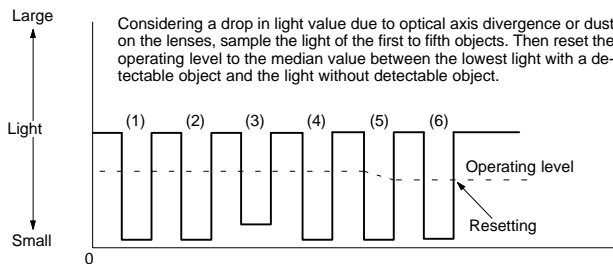

- Note:
- After no-object teaching, when the E3X-NV□ is turned off and on, the operation level will be set to the +10% of the initial light level (refer to the above (1)) in reflective operation and -10% of the initial light level in through-beam operation and stand by.
 - After performing no-object teaching and changing to RUN mode, until the first detectable object is in the sensing area, the control output will be prohibited (OFF). The control output will be determined when the first detectable object is detected.
 - The initial operating level compensation function will operate after teaching and/or after the E3X-NV□ is turned on.
 - During no-object teaching, after the E3X-NV□ is in RUN mode, the E3X-NV□ requires approximately 60 ms to determine the operating level from the time the first detectable object is in the sensing area. After the operating level is determined, the E3X-NV□ will operate with a normal response speed of 500 μs.

■ REMOTE TEACHING

Remote Teach Function

In principle, the remote teach function of the E3X-NV□ should be used for initial teaching. Basically, the method of remote teaching is the same as that of sensitivity setting. In remote teaching, instead of pressing the teach button, teach is performed with a remote teach input signal.

1. Set the mode selector to RUN.
2. The following signal conditions must be given as remote teaching input conditions.
3. If remote teaching is not performed, cut the pink wire at the base or connect the pink wire to the +V terminal.
4. After the remote teaching input setting is finished, the E3X-NV□ will be ready to detect objects in approximately one second.

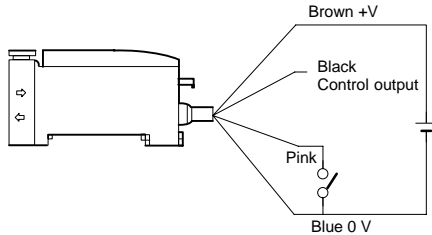

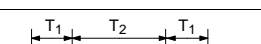
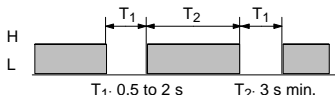
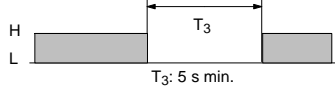
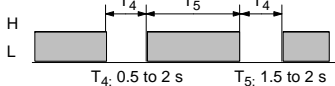
Power supply		ON  OFF 
Remote teach input	With/Without-object teaching	 T_1 : 0.5 to 2 s T_2 : 3 s min.
	Maximum sensitivity setting	 T_3 : 5 s min.
	No-object teaching	 T_4 : 0.5 to 2 s T_5 : 1.5 to 2 s

■ OPTICAL AXIS ADJUSTMENT (FLASHING FUNCTION)

Set the mode selector of the E3X-NV□ to TEACH. The flashing function of E3X-NV□ will be activated. When the optical axes of the fiber heads are divergent and the light value decreases by approximately 10% of the maximum value, the tip of the emitting fiber will start flashing and the built-in buzzer will beep. At this time, if the optical axes are divergent, adjust the axes. The peak light value will be memorized by the E3X-NV□. Do not press the teach button before or while adjusting the optical axes, or the flashing function will not operate.

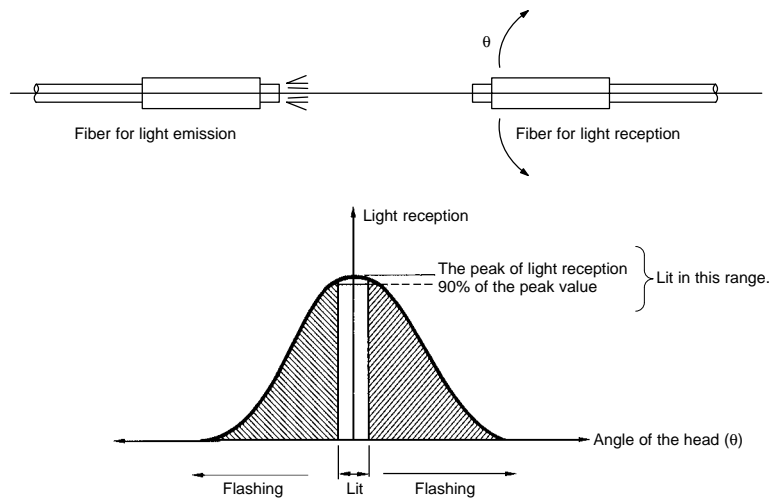

Dimensions

Unit: mm (inch)

■ E3X-NV
E3X-NVG

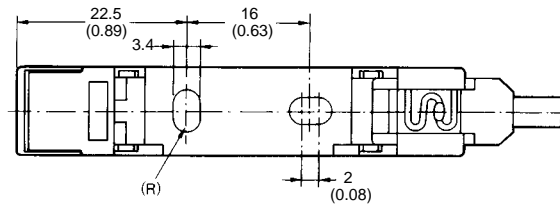
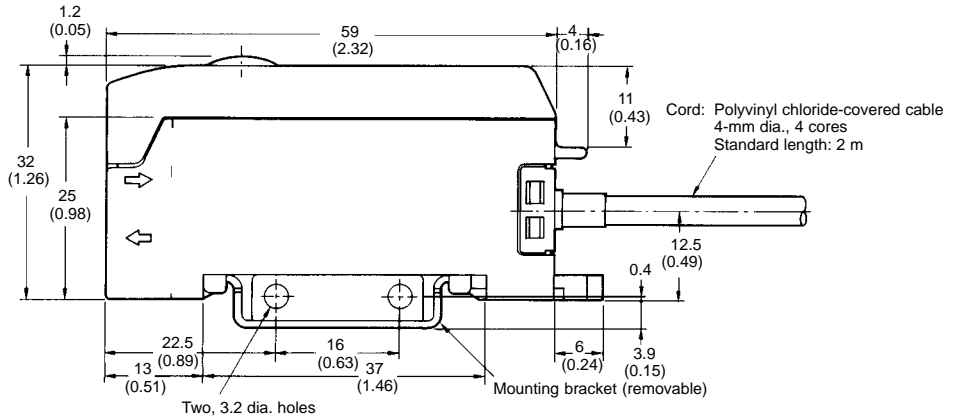
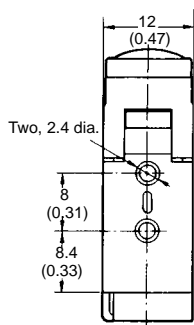
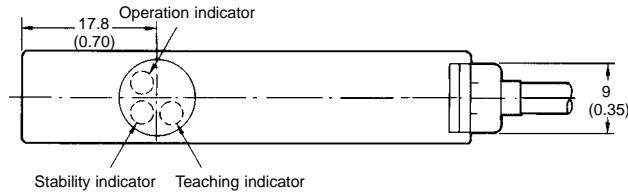
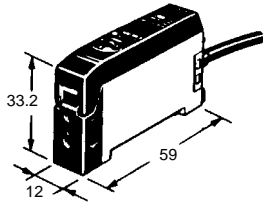

Installation

■ CONNECTION

Connection with S3D2 Sensor Controller

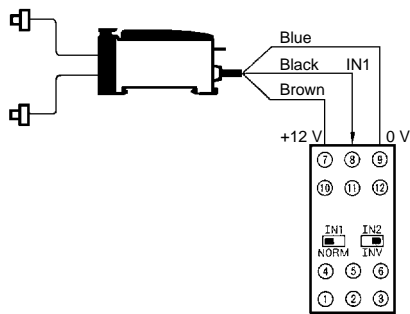

Connection with S3D8 Sensor Controller

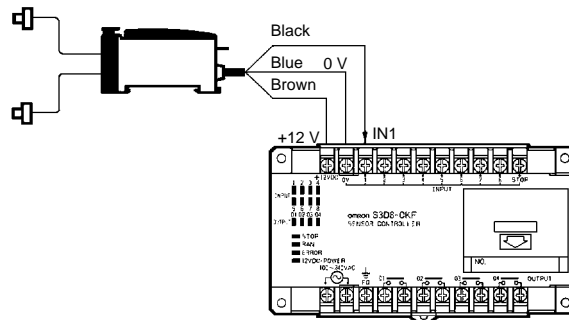

Note: A maximum of two E3X-NV□ Sensors can be connected.

Note: 1. The E3X-NV□ will switch to reverse operation by pressing the L Key.
2. A maximum of eight E3X-NV□ Sensors can be connected.

 **Caution**

■ **FIBER UNIT**

**Fiber Optic Cable
Connection and Disconnection**

The E3X-NV□ amplifier has a push lock. The fiber must be locked or released in a temperature range of -10° to 40° C. Connect or disconnect the fibers to or from the E3X-NV□ amplifier using the following procedures:

Connection

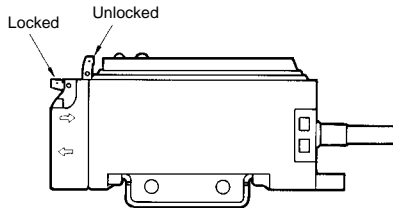

After inserting the fiber optic cable into the Unit, push down the lock lever to secure it.

After cutting the fibers with the Fiber Cutter (E39-F4), place an insertion mark on the fiber so that it can be properly inserted into the Amplifier. Insert the fiber into the Amplifier up to this insertion mark.

Disconnection

Push up the lock lever so that the fiber optic cable can be removed. To avoid damage, make sure that the fiber is unlocked before removing.

■ **AMPLIFIER**

Mounting

1. Mount the front part on the mounting bracket (sold together) or on a DIN rail.
2. Press the back part onto the mounting bracket or on to the DIN rail.

Note: To assure mounting strength: Do not mount the back part onto the mounting bracket or the DIN rail first before mounting front part on the mounting bracket or the DIN rail.

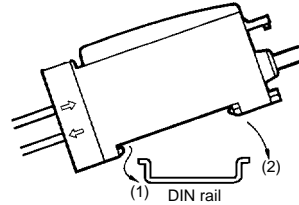

For side mounting, attach the mounting bracket on the amplifier first, and secure the amplifier with M3 screws and washers. The diameter of the washers should be 6 mm max.

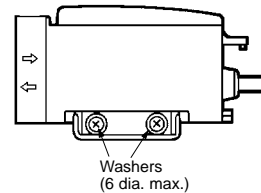

Removal

For removal, pull back the gray rail on the rear bottom with a flat-blade screwdriver so that the amplifier can be removed easily.

Precautions

⚠ WARNING

■ AVOID EXPLOSION OR FIRE

- The voltage supplied to the E3X-NV/NVG must be within the rated voltage range. If a voltage exceeding the rated upper limit is imposed on the E3X-NV/NVG.
- Connect each power line of the E3X-NV/NVG correctly.
- Do not short-circuit the load connected to the E3X-NV/NVG.

■ TURNING POWER ON

After the E3X-NV□ is turned on, it will be ready to operate in 100 ms maximum. If power is supplied to the E3X-NV□ and the load is connected to the E3X-NV□ independently, be sure to turn on the power supply connected to the E3X-NV□ first.

When the E3X-NV□ is turned on or off, no control output will be ON, even though the operation indicator of the E3X-NV□ will be lit for an instant.

■ MUTUAL INTERFERENCE PROTECTION FUNCTION

When closely connecting two to three Fiber Units to more than one E3X-NV□, perform with/without-object teaching on a single E3X-NV□ at a time. Turn on only the E3X-NV□ on which teaching is performed. If all the E3X-NV□ are turned on, interrupt the emitters of the Fiber Units on which teaching is not performed.

Power interruptions or noise caused by static electricity, etc., can result in write errors during any part of the teaching process. These errors include buzzers, lighting of teaching indicators, simultaneous flashing of red/green indicators, lighting of operation indicators, and lighting or flashing of stability indicators. If any of these occur, re-input teaching using the teaching button on the Amplifier.

Unlike experiencing teaching errors, if any memory error occurs, red/green teaching indicators will flash simultaneously, and operation indicators and stability indicators will also flash.

■ WHEN POWER IS OFF

The instant power is turned off, the E3X-NV□ could output a pulse signal which could affect the operation of the devices connected to it. This will happen more often if power is supplied to the E3X-NV□ from an external power supply, thus affecting the connected timer and counter. Use a built-in power supply to avoid this.

■ CABLE

To extend the cable, use a wire with 0.3 mm² min. The total length of the cable should be 100 m max.

■ POWER SUPPLY

If a standard switching regulator is used as a power supply, the frame ground (FG) terminal and the ground (G) terminal must be grounded, or the E3X-NV□ can malfunction, influenced by the switching noise of the power supply.

The supplied voltage must be within the rated voltage range. Unregulated full- or half-wave rectifiers must not be used as power supplies.

■ INSTALLING/WIRING

Do not wire the amplifier in the same conduit with power lines. Doing so would cause induction between the lines, possibly resulting in faulty operation or destruction. Always provide separate conduit for the wiring to the amplifier.

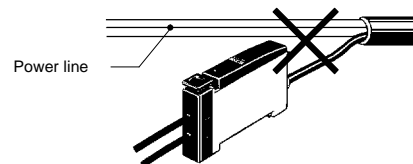

NOTE: DIMENSIONS SHOWN ARE IN MILLIMETERS. To convert millimeters to inches divide by 25.4.

OMRON®

OMRON ELECTRONICS, INC.

One East Commerce Drive
Schaumburg, IL 60173

1-800-55-OMRON

OMRON CANADA, INC.

885 Milner Avenue
Scarborough, Ontario M1B 5V8

416-286-6465

X-ON Electronics

Largest Supplier of Electrical and Electronic Components

Click to view similar products for [Sensor Fixings & Accessories](#) category:

Click to view products by [Omron](#) manufacturer:

Other Similar products are found below :

[F03-01](#) [SUS304 BINIL](#) [8000-5130](#) [FH-AP1](#) [PH-1-10M](#) [PH-1-20M](#) [PH-2-30M](#) [AC201](#) [R4](#) [ADI-LC3S](#) [EC18-WELL](#) [PC-15015](#) [K35-4](#) [A-1923](#) [SS-12143](#) [STA12](#) [AP4-T](#) [PH-1-50M](#) [R6](#) [D01051301](#) [43912557-020](#) [MF-1 D=3.2](#) [BGN-035](#) [E39-L7](#) [ZX-SB11](#) [D01070602](#) [606072](#) [606075](#) [Y92ES12PVC4A10ML](#) [Y92ES12PVC4S5ML](#) [SA9Z-F11](#) [Z49-SF1](#) [ZFV-XMF2](#) [E4R-R12A-CS3M010](#) [28810-2](#) [ZX-SW11E V3](#) [CCS-PL-LDR2-70](#) [E4R-R12A-CS3M020](#) [BS-1T CHITAN](#) [F03-01 CHITAN](#) [CCS-PD2-1012](#) [ZX-SFW11E V3](#) [PH-2-90M](#) [PH-2-5M](#) [XMLZL008](#) [AC244](#) [28810-1](#) [PH-1-40M](#) [SS-12225](#) [32043-500](#) [81532111](#)