

Thin, Compact Head Saves Space and Mounts Closely. Built-in Interference Protection Provided.

- Input indicator on the Sensor Unit simplifies settings.















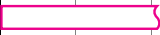







 Be sure to read *Safety Precautions* on page 8.

Ordering Information

Sensors

Sensor Units [Refer to *Dimensions* on page 9.]

 Red light  Infrared light

Sensing method	Application	Appearance	Sensing distance	Model
Through-beam (Emitter + Receiver)	Small type		 100 mm	E3C-S10 2M *1 Emitter E3C-S10L 2M Receiver E3C-S10D 2M
			 500 mm	E3C-S50 2M *1 *2 Emitter E3C-S50L 2M Receiver E3C-S50D 2M
			 1 m	E3C-1 2M *1 Emitter E3C-1L 2M Receiver E3C-1D 2M
			 2 m	E3C-2 2M *1 Emitter E3C-2L 2M Receiver E3C-2D 2M
	Slim type		 200 mm	E3C-S20W 2M
			 300 mm	E3C-S30W 2M
		Side-view		
Diffuse-reflective	Small type		 100 mm	E3C-DS10 2M
	Slim type		 50 mm	E3C-DS5W 2M
	Side-view		 100 mm	E3C-DS10T 2M
Convergent-reflective	Small type		 30±3 mm	E3C-LS3R 2M



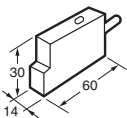

*1. Through-beam Sensors are normally sold in sets that include both the Emitter and Receiver.

*2. You cannot order the Emitter and Receiver with separate model numbers. Always order them together using the model number for the set (E3C-S50 2M).

Amplifier Units [Refer to *Amplifier Units* on page 12.]

Power supply	Application	Appearance	Functions	Model
DC	Slim type		Self diagnostic	E3C-JC4P 2M

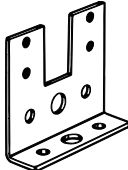
Accessories (Order Separately)
Mounting Brackets [Refer to *E39-L/E39-S/E39-R* for Dimensions.]

Appearance	Model	Quantity	Remarks
	E39-L41	2	Provided with the E3C-1.
	E39-L42	2	Provided with the E3C-2. Can be used with the E3C-DS10.
	E39-L127-T1	1	Can be used with the E3C-S10.
	E39-L127-T2	1	
	E39-L127-T3	1	
	E39-L31	1*	Can be used with the E3C-S50.

Note: Refer to *E39-L/E39-S/E39-R* for Dimensions.

* When using through-beam models, order one bracket for the Receiver and one for the Emitter.

Ratings and Specifications

Sensors

Sensing method		Through-beam					
Item	Model	E3C-S10	E3C-S20W	E3C-S50	E3C-S30T E3C-S30W	E3C-1	E3C-2
Sensing distance		100 mm	200 mm	500 mm	300 mm	1 m	2 m
Standard sensing object		Opaque, 2-mm dia. min.		Opaque, 3-mm dia. min.	Opaque, 1.5-mm dia. min.	Opaque, 4-mm dia. min.	Opaque, 8-mm dia. min.
Directional angle		Emitter/Receiver: 10 to 60° each		Emitter/Receiver: 10 to 40° each		Emitter/Receiver: 3 to 20° each	Emitter/Receiver: 3 to 15° each
Light source (wavelength)		Infrared LED (950 nm)			Infrared LED (940 nm)	Infrared LED (950 nm)	
Ambient illuminance (Receiver side)		Incandescent lamp: 3,000 lx max., Sunlight 10,000 lx max.					
Ambient temperature range		Operating/Storage: -25 to 70°C (with no icing or condensation)					
Ambient humidity range		Operating/Storage: 35% to 85%RH (with no condensation)					
Insulation resistance		20 MΩ min. at 500 VDC					
Dielectric strength		500 VAC at 50/60 Hz for 1 minute					
Vibration resistance		Destruction: 10 to 55 Hz, 1.5-mm double amplitude for 2 hours each in X, Y, and Z directions					
Shock resistance		Destruction: 500 m/s ² for 3 times each in X, Y, and Z directions					
Degree of protection		IEC 60529 IP64 Limited to indoor use	IEC 60529 IP50 Limited to indoor use	IEC 60529 IP64 Limited to indoor use	IEC 60529 IP60 Limited to indoor use	IEC 60529 IP66 Limited to indoor use	
Connection method		Pre-wired models (standard length: 2 m)					
Weight (packed state)		Approx. 50 g			Approx. 24 g	Approx. 60 g	Approx. 120 g
Material	Case	Polycarbonate		ABS	Polycarbonate		Zinc die-cast
	Lens	Polycarbonate		Acrylics	Polycarbonate		
	Mounting Brackets	---				Steel	
Accessories	Instruction manual	Phillips screw M2×8, spring washer, flat washer, M2 nut, instruction manual	Instruction manual	Phillips screw M2×8, spring washer, flat washer, nut M2, instruction manual	Mounting Bracket (with screws), instruction manual	Mounting Bracket (with screws), instruction manual	

Sensing method		Diffuse-reflective			Convergent-reflective	
Item	Model	E3C-DS5W	E3C-DS10T	E3C-DS10	E3C-LS3R	
Sensing distance		50 mm (White paper 100 × 100 mm)	100 mm (White paper 100 × 100 mm)	100 mm (White paper 50 × 50 mm)	30 ± 3 mm (White paper 10 × 10 mm)	
Differential travel		20% max. of sensing distance			10% max.	±3% max.
Light source (wavelength)		Infrared LED (950 nm)	Infrared LED (950 nm)		Red LED (680 nm)	
Ambient illuminance (Receiver side)		Incandescent lamp: 3,000 lx max., Sunlight 10,000 lx max.				
Ambient temperature range		Operating/Storage: -25 to 70°C (with no icing or condensation)				
Ambient humidity range		Operating/Storage: 35% to 85%RH (with no condensation)				
Insulation resistance		20 MΩ min. at 500 VDC				
Dielectric strength		500 VAC at 50/60 Hz for 1 minute				
Vibration resistance		Destruction: 10 to 55 Hz, 1.5-mm double amplitude for 2 hours each in X, Y, and Z directions				
Shock resistance		Destruction: 500 m/s ² for 3 times each in X, Y, and Z directions				
Degree of protection		IEC 60529 IP50 (Limited to indoor use)		IEC 60529 IP64 (Limited to indoor use)		
Connection method		Pre-wired models (standard length: 2 m)				
Weight (packed state)		Approx. 50 g			Approx. 55 g	
Material	Case	Polycarbonate				
	Lens	Polycarbonate				
Accessories		Phillips screw M2×8, spring washer, flat washer, M2 nut, instruction manual	Instruction manual			

Amplifier Units

Item	Model	E3C-JC4P
Power supply voltage		12 to 24 VDC±10%, ripple (p-p): 1 V max.
Power (current) consumption		40 mA max.
Control output		Load power supply voltage: 24 VDC max., load current: 100 mA max., NPN open collector output type (residual voltage: 1 V max.) Light-ON/Dark-ON switch selectable
Timer function		OFF-delay 0/40 ms (switch selectable)
Ambient temperature range		Operating: -10° to 55°C, Storage: -25° to 70°C (with no icing or condensation)
Ambient humidity range		Operating: 35% to 85%, Storage: 35% to 85% (with no condensation)
Insulation resistance		20 MΩ min. at 500 VDC
Dielectric strength		1,000 VAC at 50/60 Hz for 1 minute
Vibration resistance		Destruction: 10 to 55 Hz, 1.5-mm double amplitude for 2 hours each in X, Y, and Z directions
Shock resistance		Destruction: 300 ms ² three times in each of X, Y and Z directions
Degree of protection		IEC IP40 (limited to indoor use)
Protection		Reverse polarity protection, output short-circuit protection, mutual interference prevention
Response time		Operate or reset: 1 ms max.
Connection method		Terminal block input cable pullout (standard cable length: 2 m)
Weight (packed state)		Approx. 80 g
Material	Case	ABS
	Mounting Brackets	Iron
Accessories		Mounting Bracket, Adjustment screwdriver, Caution label, Instruction manual

Engineering Data (Reference Value)

Parallel Operating Range

Through-beam

E3C-S10

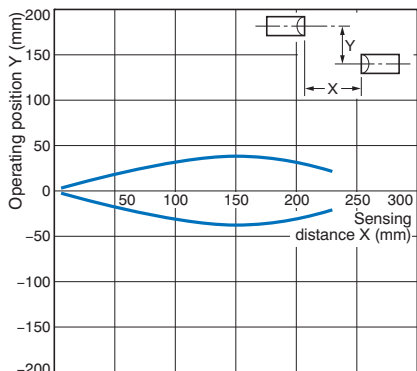

Through-beam

E3C-S20W

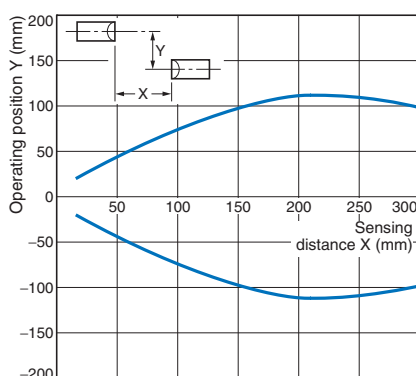

Through-beam

E3C-S50

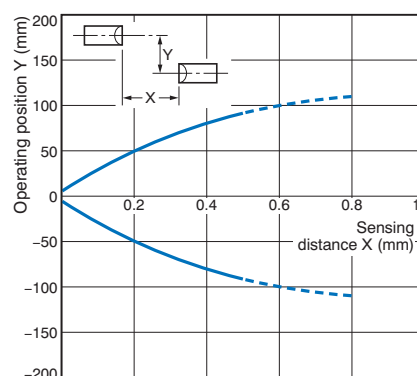

Through-beam

E3C-1

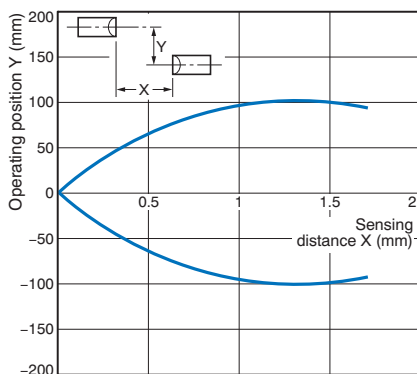

Through-beam

E3C-2

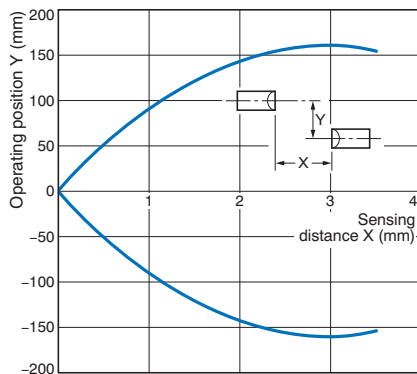

Through-beam

E3C-S30T/-S30W

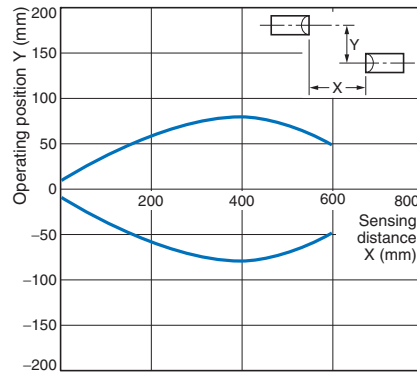

Operating Range

Diffuse-reflective

E3C-DS5W

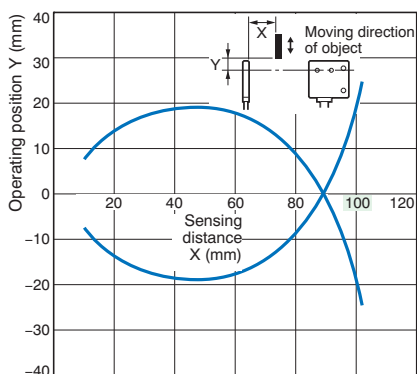

Diffuse-reflective

E3C-DS10T

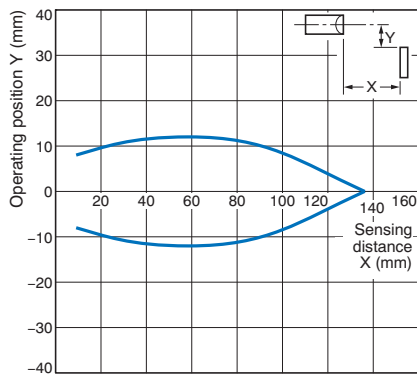

Diffuse-reflective

E3C-DS10 (Example 1)

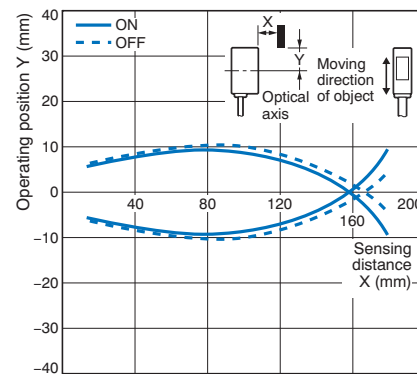

Diffuse-reflective
E3C-DS10 (Example 2)

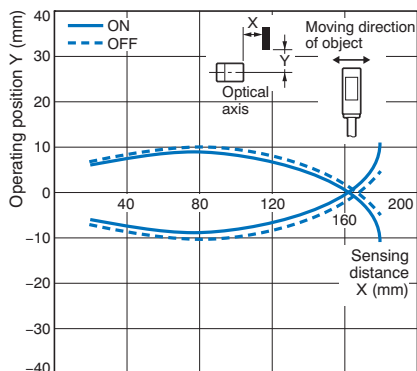

Convergent-reflective
E3C-LS3R (Example 1)

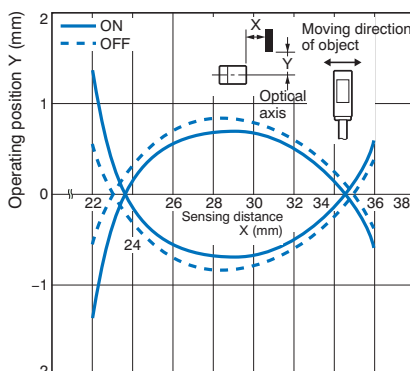

Convergent-reflective
E3C-LS3R (Example 2)

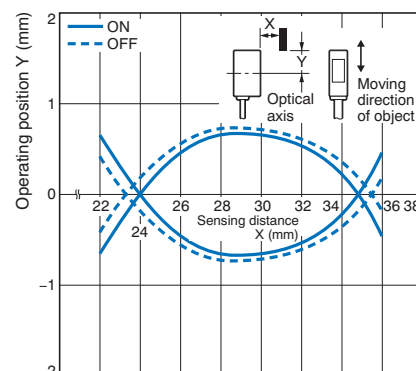

Excess Gain vs. Set Distance

E3C-S20W

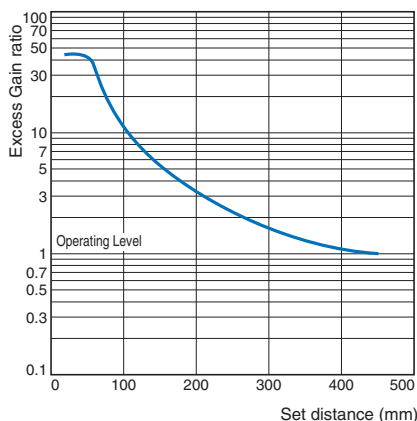

E3C-S30T/-S30W

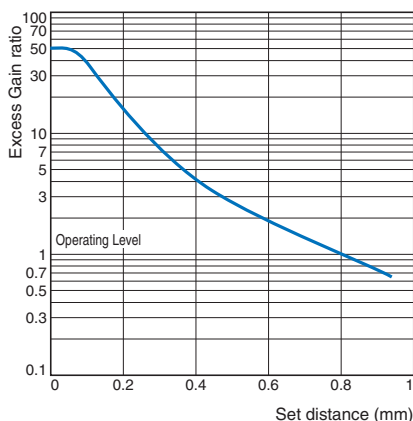

E3C-S50

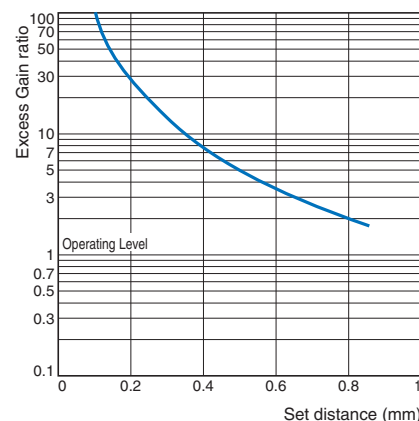

E3C-DS5W

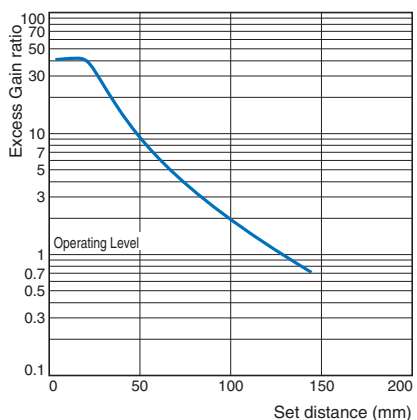

E3C-DS10T

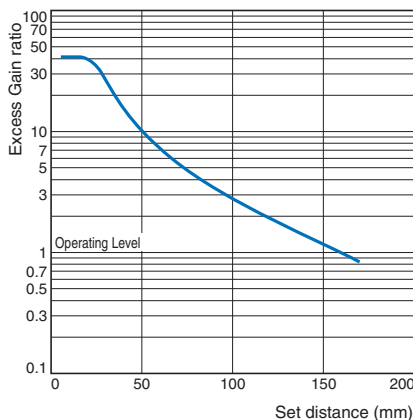

E3C-LS3R

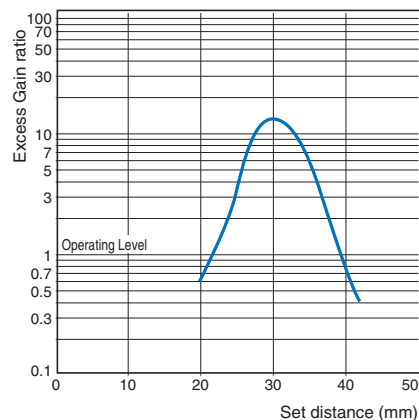

I/O Circuit Diagrams

NPN output

Model	Operation mode	Timing charts	Operation selector	Output circuit
E3C-JC4P	Light-ON	<p>Incident light: ON (green bar) No incident light: OFF Light indicator (red): ON (green bar) OFF (green bar) Output transistor: ON (green bar) OFF (green bar) Load (relay etc.): ON (green bar) OFF (green bar) 40 ms scale bar</p>	L-ON (LIGHT ON)	<p>Light indicator (red) Stability indicator (green) Photo-electric Sensor Main Circuit Brown 12 to 24 VDC Black Output Load 100 mA max. Blue 0 V Orange Self diagnostic output 50 mA max.</p>
	Dark-ON	<p>Incident light: ON (green bar) No incident light: OFF Light indicator (red): OFF (green bar) ON (green bar) Output transistor: ON (green bar) OFF (green bar) Load (relay etc.): ON (green bar) OFF (green bar) 40 ms scale bar</p>	D-ON (DARK ON)	

Connection

Amplifier Units	Connected to the through-beam model	Connected to the reflective model	Note
E3C-JC4P			<p>Note: 1. The strip-off length of the shielded cable should always be 20 mm max. on the Receiver side (white) and 50 mm max. on the Emitter side (red).</p>

Nomenclature/Settings

Amplifier Units	Nomenclature
E3C-JC4P	<p>Stability indicator (green) Sensitivity adjuster (4-turn endless adjuster) Light indicator (red) Operation selector</p>

Safety Precautions

Refer to *Warranty and Limitations of Liability*.

⚠ WARNING

This product is not designed or rated for ensuring safety of persons either directly or indirectly. Do not use it for such purposes.



Precautions for Correct Use

Do not use the product in atmospheres or environments that exceed product ratings.

Amplifier Units

● Wiring

Connection of Amplifier Unit and Sensor

Always run the shielded wires of the Emitter and Receiver separately. Also, route the sensor cable along the cable grooves of the cover and sensor and fix it with the cover.

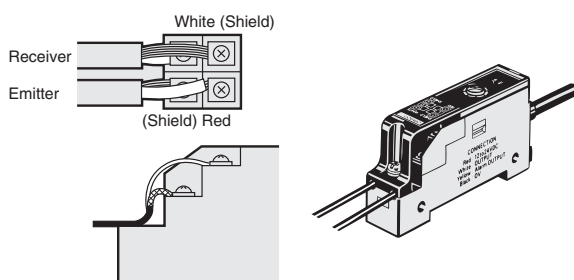

Sensor Units

● Wiring

Extension Cable

- The extension distance of the sensor connection cable should be within 10 m including sensor cable.
- The strip-off length of the core in the connection cable should be 20 mm max. on the Receiver side and 50 mm max. on the Emitter side, and the core should be as short as possible. Avoid using the joint terminal and connector.

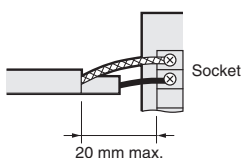

- Use independent shielded wires for the Emitter and Receiver. Using a common shielded wire can cause a malfunction.

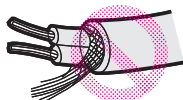

Extension Cable

Through-beam

Model	Specified cable	Replacement cable
E3C-S10 E3C-1 E3C-2 E3C-S50	Polyethylene insulation shield Round cable 2.4 dia. Shield White (polyethylene) 12-conductor, 0.18 dia.	1-conductor shield/ vinyl wire, conductor cross section: 0.3 mm ² min. Shield White (vinyl) Gray (vinyl sheath)
E3C-S20W	Vinyl insulation shield round cable 1.7 dia. Sheath Shield Polyethylene Conductor 12-conductor, 0.18 dia.	1-conductor shield/ vinyl wire, conductor cross section: 0.3 mm ² min.
E3C-S30T E3C-S30W	Vinyl insulation shield round cable (robot cable) 1.8 dia. Sheath Shield Polyethylene Conductor 30-conductor, 0.08 dia.	1-conductor shield/ vinyl wire, conductor cross section: 0.3 mm ² min.

Reflective model

Model	Specified cable	Replacement cable
E3C-DS10 E3C-DS10T E3C-VS1G E3C-VS3R E3C-LS3R	Vinyl insulation shielded parallel cable 2.4 4.3 Sheath Internal sheath Shield Polyethylene Conductor 12-conductor, 0.18 dia.	When there is no 1- conductor shielded, vinyl cable (parallel wire), use two 1- conductor shielded, vinyl wires.
E3C-DS5W E3C-VS7R E3C-VM35R	Vinyl insulation shielded parallel cable Sheath Shield Polyethylene Conductor 7-conductor, 0.18 dia.	When there is no 1- conductor shielded, vinyl cable (parallel wire), use two 1- conductor shielded, vinyl wires.

● Others

When the E3C is used in a place where high-frequency noise will be generated, e.g. ultrasonic welder, grounding the 0-V terminal (on the shield side of the connection cable) of the Receiver may avoid a malfunction caused by induction.

Dimensions

Tolerance class IT16 applies to dimensions in this data sheet unless otherwise specified.

Sensors

Sensor Units

E3C-S10



Emitter: E3C-S10L
Receiver: E3C-S10D

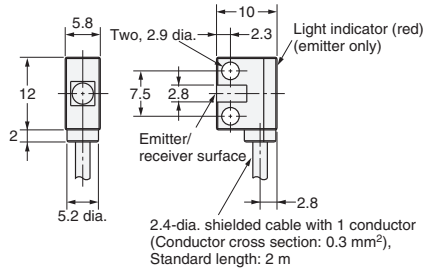

E3C-S50



Emitter: E3C-S50L
Receiver: E3C-S50D

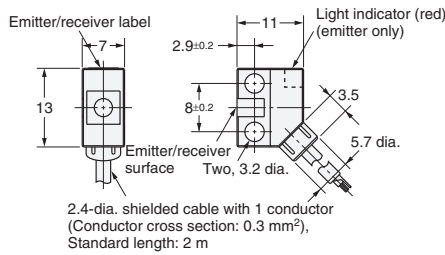

E3C-1

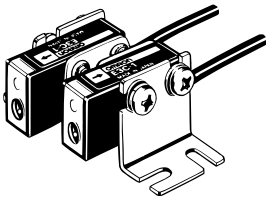

Emitter: E3C-1L
Receiver: E3C-1D

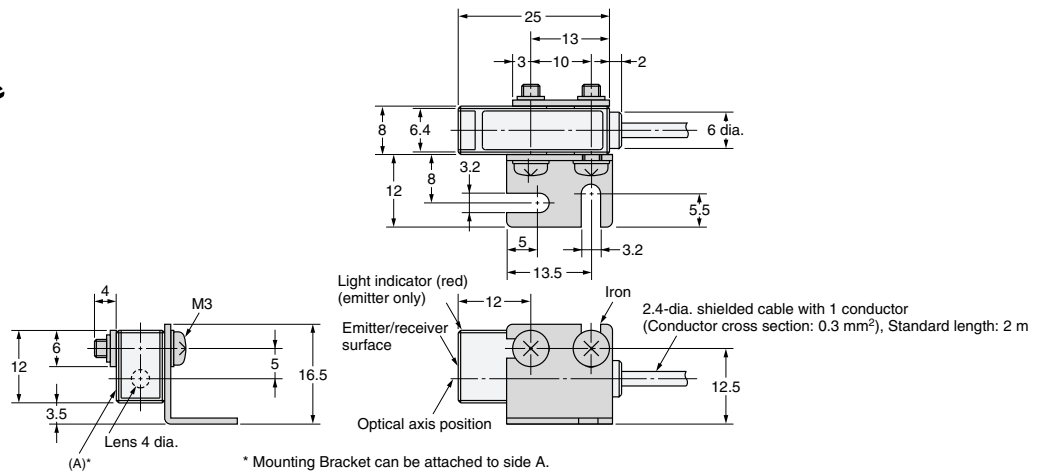

E3C-2

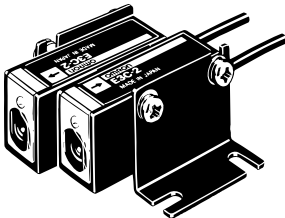

Emitter: E3C-2L
Receiver: E3C-2D

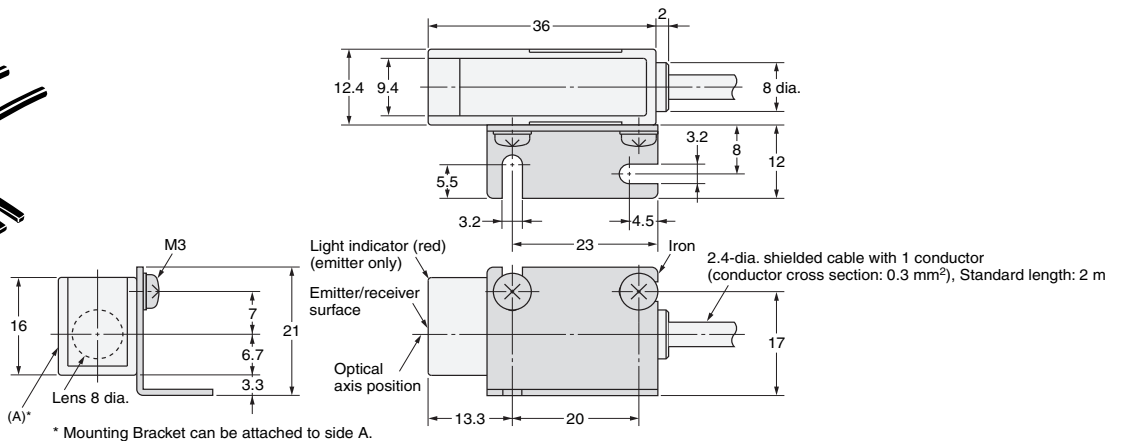

E3C-S20W

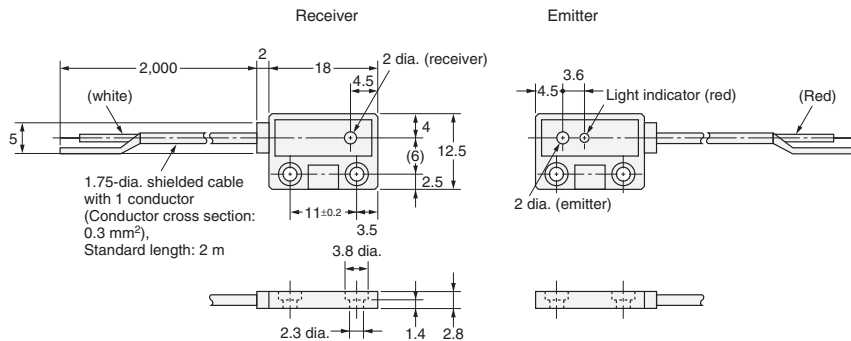
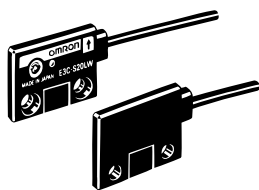

Emitter: E3C-S20LW
Receiver: E3C-S20DW

E3C-S30W

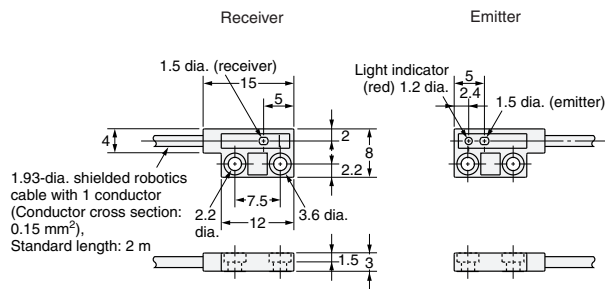
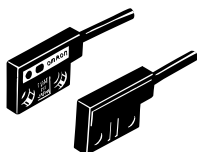

Emitter: E3C-S30LW
Receiver: E3C-S30DW

E3C-S30T

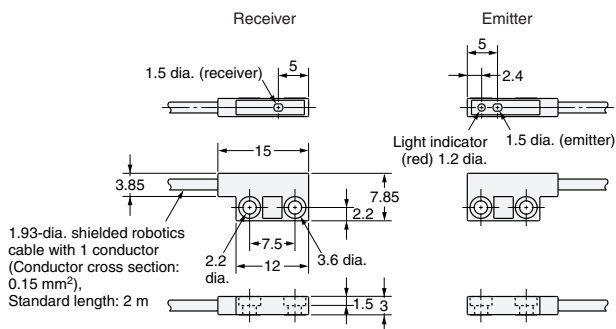
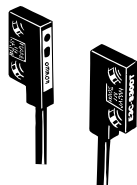

Emitter: E3C-S30LT
Receiver: E3C-S30DT

E3C-DS10

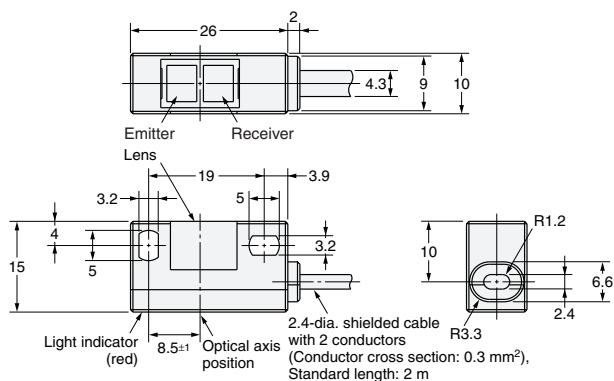
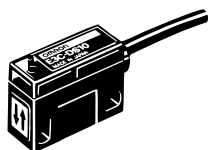

E3C-DS5W

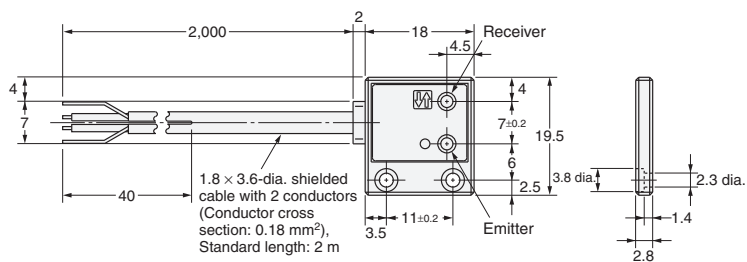
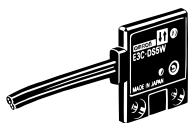

E3C-DS10T

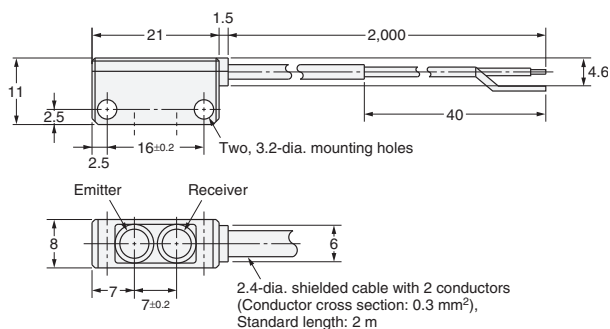

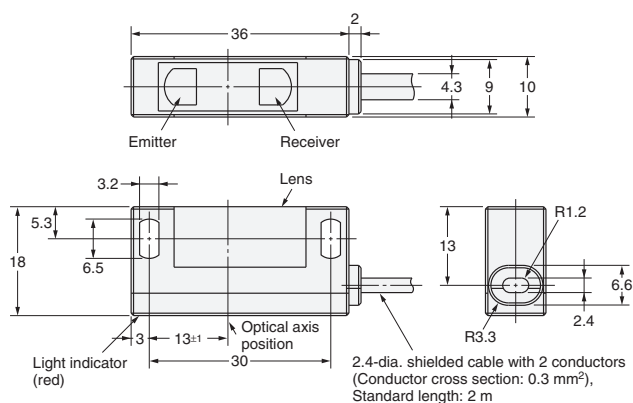
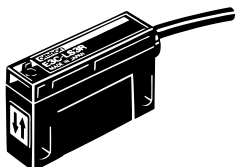

E3C-LS3R

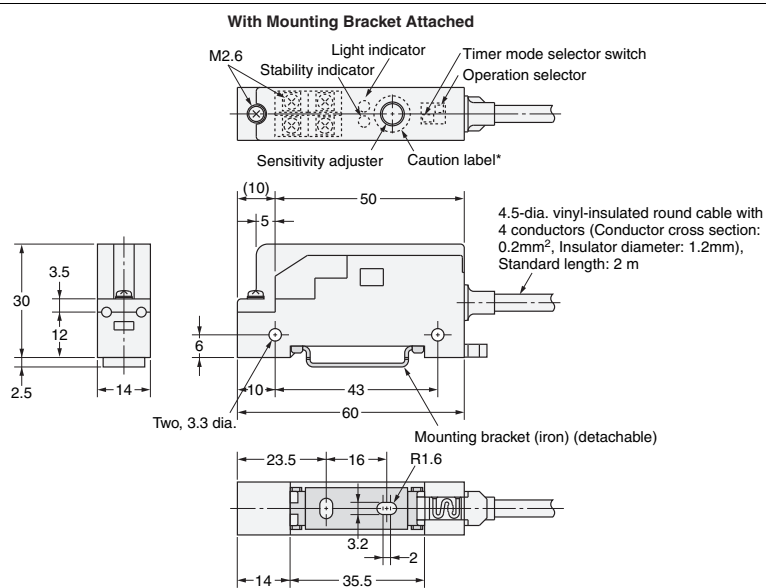
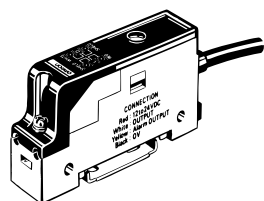

Amplifier Units

E3C-JC4P



*After adjusting the sensitivity, attach the caution label at the location indicated by  above to prevent malfunction.

Accessories (Order Separately)

Mounting Brackets

Refer to *E39-L/E39-S/E39-R* for details.

Terms and Conditions Agreement

Read and understand this catalog.

Please read and understand this catalog before purchasing the products. Please consult your OMRON representative if you have any questions or comments.

Warranties.

(a) Exclusive Warranty. Omron's exclusive warranty is that the Products will be free from defects in materials and workmanship for a period of twelve months from the date of sale by Omron (or such other period expressed in writing by Omron). Omron disclaims all other warranties, express or implied.

(b) Limitations. OMRON MAKES NO WARRANTY OR REPRESENTATION, EXPRESS OR IMPLIED, ABOUT NON-INFRINGEMENT, MERCHANTABILITY OR FITNESS FOR A PARTICULAR PURPOSE OF THE PRODUCTS. BUYER ACKNOWLEDGES THAT IT ALONE HAS DETERMINED THAT THE PRODUCTS WILL SUITABLY MEET THE REQUIREMENTS OF THEIR INTENDED USE.

Omron further disclaims all warranties and responsibility of any type for claims or expenses based on infringement by the Products or otherwise of any intellectual property right. (c) Buyer Remedy. Omron's sole obligation hereunder shall be, at Omron's election, to (i) replace (in the form originally shipped with Buyer responsible for labor charges for removal or replacement thereof) the non-complying Product, (ii) repair the non-complying Product, or (iii) repay or credit Buyer an amount equal to the purchase price of the non-complying Product; provided that in no event shall Omron be responsible for warranty, repair, indemnity or any other claims or expenses regarding the Products unless Omron's analysis confirms that the Products were properly handled, stored, installed and maintained and not subject to contamination, abuse, misuse or inappropriate modification. Return of any Products by Buyer must be approved in writing by Omron before shipment. Omron Companies shall not be liable for the suitability or unsuitability or the results from the use of Products in combination with any electrical or electronic components, circuits, system assemblies or any other materials or substances or environments. Any advice, recommendations or information given orally or in writing, are not to be construed as an amendment or addition to the above warranty.

See <http://www.omron.com/global/> or contact your Omron representative for published information.

Limitation on Liability; Etc.

OMRON COMPANIES SHALL NOT BE LIABLE FOR SPECIAL, INDIRECT, INCIDENTAL, OR CONSEQUENTIAL DAMAGES, LOSS OF PROFITS OR PRODUCTION OR COMMERCIAL LOSS IN ANY WAY CONNECTED WITH THE PRODUCTS, WHETHER SUCH CLAIM IS BASED IN CONTRACT, WARRANTY, NEGLIGENCE OR STRICT LIABILITY.

Further, in no event shall liability of Omron Companies exceed the individual price of the Product on which liability is asserted.

Suitability of Use.

Omron Companies shall not be responsible for conformity with any standards, codes or regulations which apply to the combination of the Product in the Buyer's application or use of the Product. At Buyer's request, Omron will provide applicable third party certification documents identifying ratings and limitations of use which apply to the Product. This information by itself is not sufficient for a complete determination of the suitability of the Product in combination with the end product, machine, system, or other application or use. Buyer shall be solely responsible for determining appropriateness of the particular Product with respect to Buyer's application, product or system. Buyer shall take application responsibility in all cases.

NEVER USE THE PRODUCT FOR AN APPLICATION INVOLVING SERIOUS RISK TO LIFE OR PROPERTY OR IN LARGE QUANTITIES WITHOUT ENSURING THAT THE SYSTEM AS A WHOLE HAS BEEN DESIGNED TO ADDRESS THE RISKS, AND THAT THE OMRON PRODUCT(S) IS PROPERLY RATED AND INSTALLED FOR THE INTENDED USE WITHIN THE OVERALL EQUIPMENT OR SYSTEM.

Programmable Products.

Omron Companies shall not be responsible for the user's programming of a programmable Product, or any consequence thereof.

Performance Data.

Data presented in Omron Company websites, catalogs and other materials is provided as a guide for the user in determining suitability and does not constitute a warranty. It may represent the result of Omron's test conditions, and the user must correlate it to actual application requirements. Actual performance is subject to the Omron's Warranty and Limitations of Liability.

Change in Specifications.

Product specifications and accessories may be changed at any time based on improvements and other reasons. It is our practice to change part numbers when published ratings or features are changed, or when significant construction changes are made. However, some specifications of the Product may be changed without any notice. When in doubt, special part numbers may be assigned to fix or establish key specifications for your application. Please consult with your Omron's representative at any time to confirm actual specifications of purchased Product.

Errors and Omissions.

Information presented by Omron Companies has been checked and is believed to be accurate; however, no responsibility is assumed for clerical, typographical or proofreading errors or omissions.

2015.9

In the interest of product improvement, specifications are subject to change without notice.

OMRON Corporation
Industrial Automation Company

<http://www.ia.omron.com/>

(c)Copyright OMRON Corporation 2015 All Right Reserved.

X-ON Electronics

Largest Supplier of Electrical and Electronic Components

Click to view similar products for [Photoelectric Sensors](#) category:

Click to view products by [Omron](#) manufacturer:

Other Similar products are found below :

[E3JM-DS70R4T-US](#) [E3L2DC4](#) [E3RA-DN12 2M](#) [E3RA-DP12 2M](#) [E3S5LE4S](#) [E3S-AD38](#) [E3S-CR11 5M](#) [E3SCT11D5M](#) [E3SCT11M1J03M](#)
[E3T-SL14R](#) [E3T-SL24 5M](#) [E3T-ST12R](#) [E3X-CN02](#) [E3X-CN11 5M](#) [E3X-CN21 10M](#) [E3ZM-B66](#) [E3ZM-CL81H 2M](#) [E3Z-T62 2M](#)
[NJL5303R-TE1](#) [PB10CNT15PO](#) [PD60CNX20BP](#) [CX-491-P-J](#) [CX-491-Z](#) [XUM2BKCNL2T](#) [XUM2BKCNL2T](#) [XUM2BNANL2R](#) [Y92E-](#)
[ES30M](#) [Y92E-GS08SS](#) [ZXTDS04T](#) [ZX-XC4A 4M](#) [E3E23Y2US](#) [E3JM-DS70S4-US](#) [E3RA-RN11 2M](#) [E3S5LE42M](#) [E3S-LS20XB4 5M](#)
[E3TFD14N](#) [E3T-FD14R](#) [E3T-SL21 5M](#) [E3T-SL21M](#) [E3T-ST11R](#) [E3T-ST12 5M](#) [E3X-DA41-S-M1J 0.3M](#) [E3X-DAB6](#) [E3X-DAG8](#) [E3ZM-](#)
[B86](#) [E3ZM-CR81 2M](#) [E3ZM-CR86](#) [E3Z-T61A-L 2M](#) [ZX-XGC2R](#) [ZX-XB1A](#)