

## Miniature photoelectric sensors in cylindrical M8 and M12 housing

# E3H2

- M8 or M12 sized cylindrical housings when mounting space is crucial
- Retro-reflective models with two teaching modes for standard and semi-transparent objects
- pre-wired and connector models



### Ordering Information

#### M12 cylindrical housing

Sensor type	Sensing distance	Operation mode	Connection method				Order code	
							NPN output	PNP output
Through-beam 	4 m (adjustable)	light on / dark on selectable	-	-	2 m	-	E3H2-T4C4M 2M	E3H2-T4B4M 2M
			-	■	-	-	E3H2-T4C4M-M1	E3H2-T4B4M-M1
Retro-reflective with M.S.R. 	2 m (teachable* <sup>1</sup> )		-	-	2 m	-	E3H2-R2C4M 2M* <sup>2</sup>	E3H2-R2B4M 2M* <sup>2</sup>
			-	■	-	-	E3H2-R2C4M-M1* <sup>2</sup>	E3H2-R2B4M-M1* <sup>2</sup>
Diffuse-reflective 	300 mm (teachable)		-	-	2 m	-	E3H2-DS30C4M 2M	E3H2-DS30B4M 2M
			-	■	-	-	E3H2-DS30C4M-M1	E3H2-DS30B4M-M1
	100 mm (fixed)		-	-	2 m	-	E3H2-DS10C4M 2M	E3H2-DS10B4M 2M
			-	■	-	-	E3H2-DS10C4M-M1	E3H2-DS10B4M-M1

\*1. Models without teach-button are available. Contact your OMRON representative.





\*2. Without reflector; order reflector separately

#### M8 cylindrical housing





Sensor type	Sensing distance	Operation mode	Connection method				Order code	
							NPN output	PNP output
Through-beam 	2 m	dark on	-	-	2 m	-	E3H2-T2C2S 2M	E3H2-T2B2S 2M
			■	-	-	-	E3H2-T2C2S-M5	E3H2-T2B2S-M5
		light on	-	-	2 m	-	E3H2-T2C1S 2M	E3H2-T2B1S 2M
			■	-	-	-	E3H2-T2C1S-M5	E3H2-T2B1S-M5

Accessories

Reflectors

Shape	Type	Material	Features	Size in mm	Applicable Sensor	Order code
	General purpose reflectors	- ABS base - Acrylic surface	Surface screw mounting (diagonal holes)	60x40x7.5	- Retro-reflective photoelectric sensors – non polarizing - Retro-reflective photoelectric sensors – polarizing (MSR)	E39-R1S
	Small size		Surface screw mounting	23x13.7x4.9		E39-R4
	Simple mounting		Round shape with centered mounting hole for simple screw mounting	Diameter: 84 Depth: 7.4		E39-R7
	General purpose tape reflectors	- Acrylic	Self adhesive Pre cut	40x35x0.6		E39-RS2

Sensor I/O connectors

Size	Shape	Type	Features	Material		Order code	
				Nut	Cable		
M8		General purpose (screw)	3 pin (LED optionally)	Brass (CuZn)	PVC 2 m	XS3F-M08PVC3S2M	XS3F-M08PVC3A2M
					PUR 2 m	XS3F-M08PUR3S2M	XS3F-M08PUR3A2M
M12		General purpose (screw)	3 wire (LED optionally)	Brass (CuZn)	PVC 2 m	XS2F-M12PVC3S2M	XS2F-M12PVC3A2M
					PUR 2 m	XS2F-M12PUR3S2M	XS2F-M12PUR3A2M
			4 wire		PVC 2 m	XS2F-M12PVC4S2M	XS2F-M12PVC4A2M
					PUR 2 m	XS2F-M12PUR4S2M	XS2F-M12PUR4A2M

Note: For the complete list of sensor I/O connectors refer to E26E Accessories datasheet.

Specifications

Item	Through-beam		Retro-reflective with M.S.R.	Diffuse-reflective	
	E3H2-T4	E3H2-T2	E3H2-R	E3H2-DS30	E3H2-DS10
Sensing distance	4 m (adjustable)	2 m	2 m (teachable) (when using E39-R1S)	300 mm (teachable)	100 mm (fixed)
Differential travel	20% max of sensing distance	10% max of sensing distance			
Light source (wave length)	Infrared LED (880 nm)		Red LED (660 nm)	Infrared LED (880 nm)	
Power supply voltage	10 to 30 VDC, 10% ripple				
Current consumption	45 mA max				
Control output	Load current: 100 mA max. (residual voltage 2 V max.); E3H2_C_: NPN E3H2_B_: PNP				
	Light-on/dark-on selectable by wire	E3H2-T2_2_: dark on E3H2-T2_1_: light on	Light-on/dark-on selectable by wire		
Protective circuits	Power supply reverse polarity protection, output short circuit protection				
Response time	Operation or reset: 2.5 ms max	Operation or reset: 1 ms max.	Operation or reset: 1.1 ms max		
Sensitivity adjustment	Potentiometer adjuster	–	Teach-in	–	
Ambient illumination	Incandescent lamp: 1500 lx max.; Sunlight: 5000 lx max.				
Ambient temperature	Operating: -25 to +55°C	Operating: -25 to +50°C	Operating: -25 to +55°C		
Degree of protection	EN 60529: IP67				
Indicators	Emitter: Power supply indicator: yellow Receiver: Operation indicator: yellow		Output indicator: yellow		
Weight pre-wired connector	approx 110 g approx 40 g	approx 90 g approx 30 g	approx 55 g approx 20 g		
Material case lens	nickel-plated brass plastic	stainless steel plastic	nickel-plated brass plastic		

## Operation

### Sensitivity adjustment

#### E3H2-T4

The emitter of the E3H2-T4 allows an adjustment of the emitted amount of light by turning the potentiometer. Turn the potentiometer clockwise for increasing the amount of emitted light and counter-clockwise for decreasing the amount of emitted light.

#### E3H2-R2

##### a) standard mode

To teach the retro-reflective model E3H2-R, place the sensor with the lens facing the reflector. Press the teach button for 2-5 seconds. For remote teach connect the white wire (Pin 2) for 2-5 seconds to common (-).

The threshold is now set to 50% of the received light level.

##### b) high sensitivity mode (e.g. for semi-transparent models)

To teach the retro-reflective model E3H2-R in high sensitivity mode, place the sensor with the lens facing the reflector. Press the teach button for >8 seconds. For remote teach connect the white wire (Pin 2) for >8 seconds to common (-).

The threshold is now set just below the received light level.

If the teaching was successful the LED should no longer be flashing and a state change occurs when the light is interrupted.

#### E3H2-DS30

##### a) standard mode

To teach the diffuse-reflective model E3H2-DS30, place the object in front of the sensor at the required sensing distance. Press the teach button for 2-5 seconds. For remote teach connect the white wire (Pin 2) for 2-5 seconds to common (-). The threshold is now set to 50% of the received light level.

When the object is removed, a state change at the sensor should occur. If this is not the case the high sensitivity mode may be required.

##### b) high sensitivity mode

To teach the diffuse-reflective model E3H2-DS30 in high sensitivity mode, place the object in front of the sensor at the required sensing distance. Press the teach button for >8 seconds. For remote teach connect the white wire (Pin 2) for >8 seconds to common (-).

The threshold is now set just below the received light level. When the object is removed, a state change at the sensor should occur and the LED should no longer be flashing.

For E3H2-T2 and E3H2-DS10 the sensitivity setting is fixed.

### Operation mode selection

The light-on / dark-on operation mode can be selected by wire (except for E3H2-T2). The white wire (Pin 2) can be connected to plus (+), common (-) or left open (not connected) for the default setting.

#### a) E3H2-T4 Receiver

Default setting (wire left open): DARK-ON

Connected to plus (+): LIGHT-ON

Connected to common (-): DARK-ON

#### b) E3H2-R2

Default setting (wire left open): DARK-ON

Connected to plus (+): LIGHT-ON

Connected to common (-): TEACH<sup>\*1</sup>

#### c) E3H2-DS30

Default setting (wire left open): LIGHT-ON

Connected to plus (+): DARK-ON

Connected to common (-): TEACH<sup>\*1</sup>

#### d) E3H2-DS10

Default setting (wire left open): LIGHT-ON

Connected to plus (+): DARK-ON

Connected to common (-): LIGHT-ON

For E3H2-T2 the operation mode is fixed and models with light-on and dark-on operation are available.

<sup>\*1</sup> In case the remote teach operation is required when the white wire is connected to plus (+), add a 2.2 kΩ resistor between the white wire and (+) to avoid a short circuit.

## Engineering data (typical)

### Parallel operating range

#### Through-beam models

##### E3H2-T4

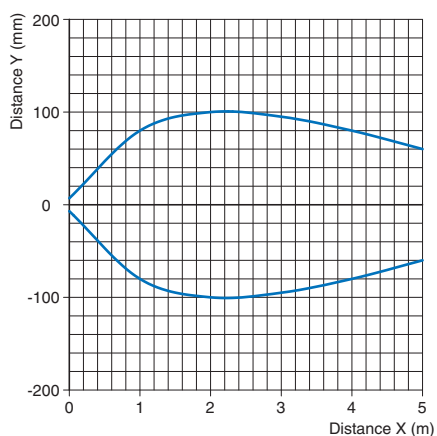

##### E3H2-T2

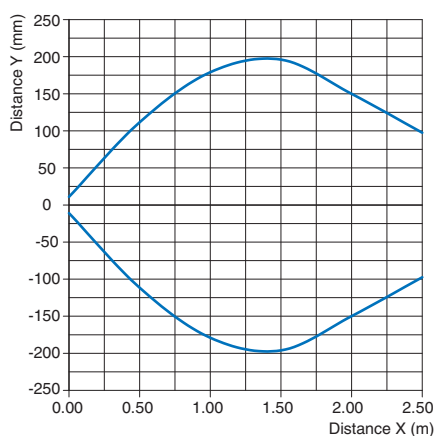

#### Retroreflective models

##### E3H2-R2

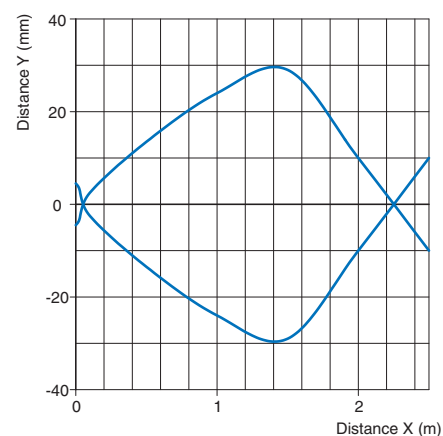

### Operating range

#### Diffuse reflective models

##### E3H2-DS30

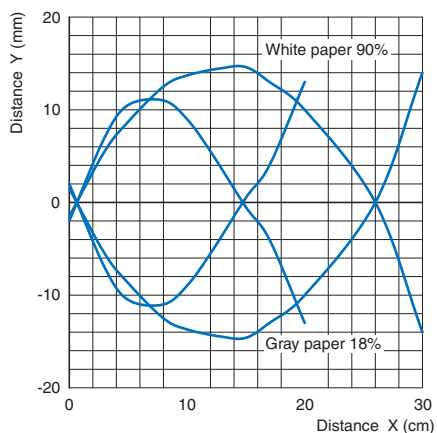

##### E3H2-DS10

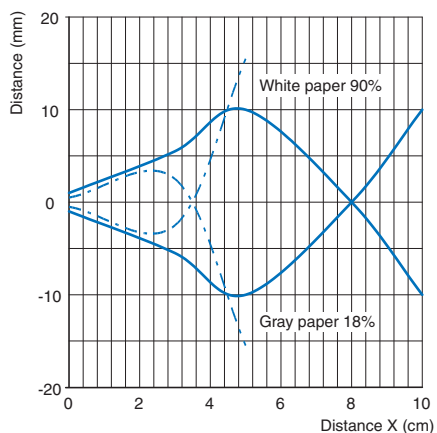

### Excess gain vs. distance

#### Through-beam models

##### E3H2-T4

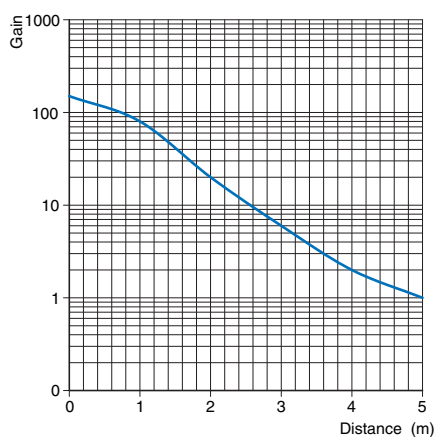

##### E3H2-T2

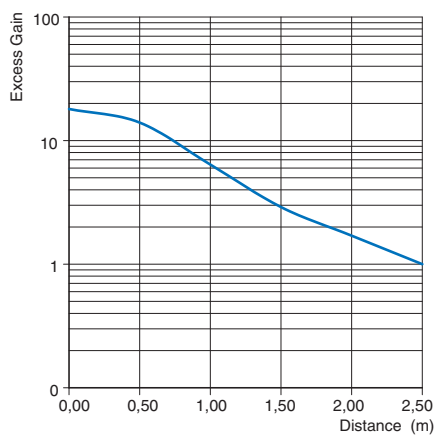

#### Retroreflective Models

##### E3H2-R2

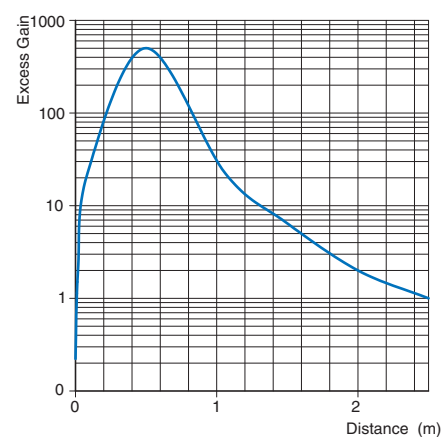

Diffuse reflective Models

E3H2-DS30

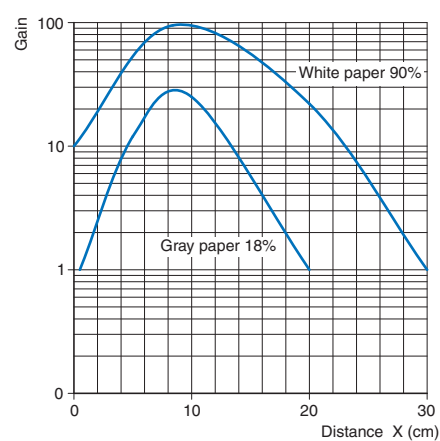

E3H2-DS10

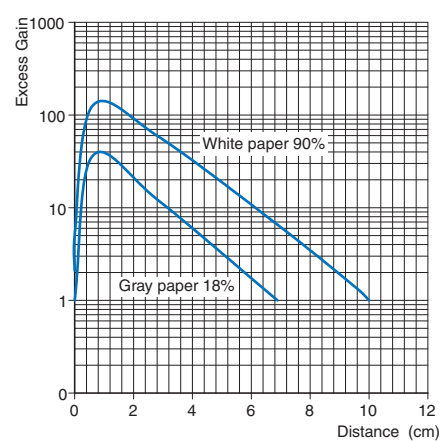

Output Circuit Diagram

PNP Output

Model	Operation mode	Timing charts	Mode selector switch	Output circuit
E3H2-T4B□ E3H2-R2B□ E3H2-D□B□	Light ON		<p>For through-beam and retro-reflective: connect the white wire (Pin 2) to the brown wire (Pin 1).</p> <p>For diffuse-reflective: open (do not connect) the white wire (Pin 2).</p>	<p>Through-beam receiver, retro-reflective, diffuse-reflective</p> <p>Connector Pin Arrangement</p>
	Dark ON		<p>For through-beam and retro-reflective: open (do not connect) the white wire (Pin 2).</p> <p>For diffuse-reflective: connect the white wire (Pin 2) to the brown wire (Pin 1).</p>	<p>Through-beam emitter</p> <p>Connector Pin Arrangement</p>
E3H2-T2B□	Light ON		n.a. fixed for E3H2-T2B1□	<p>Through-beam receiver</p> <p>Connector Pin Arrangement</p>
	Dark ON		n.a. fixed for E3H2-T2B2□	<p>Through-beam emitter</p> <p>Connector Pin Arrangement</p>

NPN Output

Model	Operation mode	Timing charts	Mode selector switch	Output circuit
E3H2-T4C□ E3H2-R2C□ E3H2-D□C□	Light ON		<p>For through-beam and retro-reflective: connect the white wire (Pin 2) to the brown wire (Pin 1).</p> <p>For diffuse-reflective: open (do not connect) the white wire (Pin 2).</p>	<p>Through-beam receiver, retro-reflective, diffuse-reflective</p> <p>Connector Pin Arrangement</p>
	Dark ON		<p>For through-beam and retro-reflective: open (do not connect) the white wire (Pin 2).</p> <p>For diffuse-reflective: connect the white wire (Pin 2) to the brown wire (Pin 1)</p>	
		<p>Through-beam emitter</p> <p>Connector Pin Arrangement</p>		
E3H2-T2C□	Light ON		n.a. - fixed for E3H2-T2C1□	<p>Through-beam receiver</p> <p>Connector Pin Arrangement</p>
	Dark ON		n.a. - fixed for E3H2-T2C2□	
		<p>Through-beam emitter</p> <p>Connector Pin Arrangement</p>		



## Dimensions

Note: All units are in millimeters unless otherwise stated.

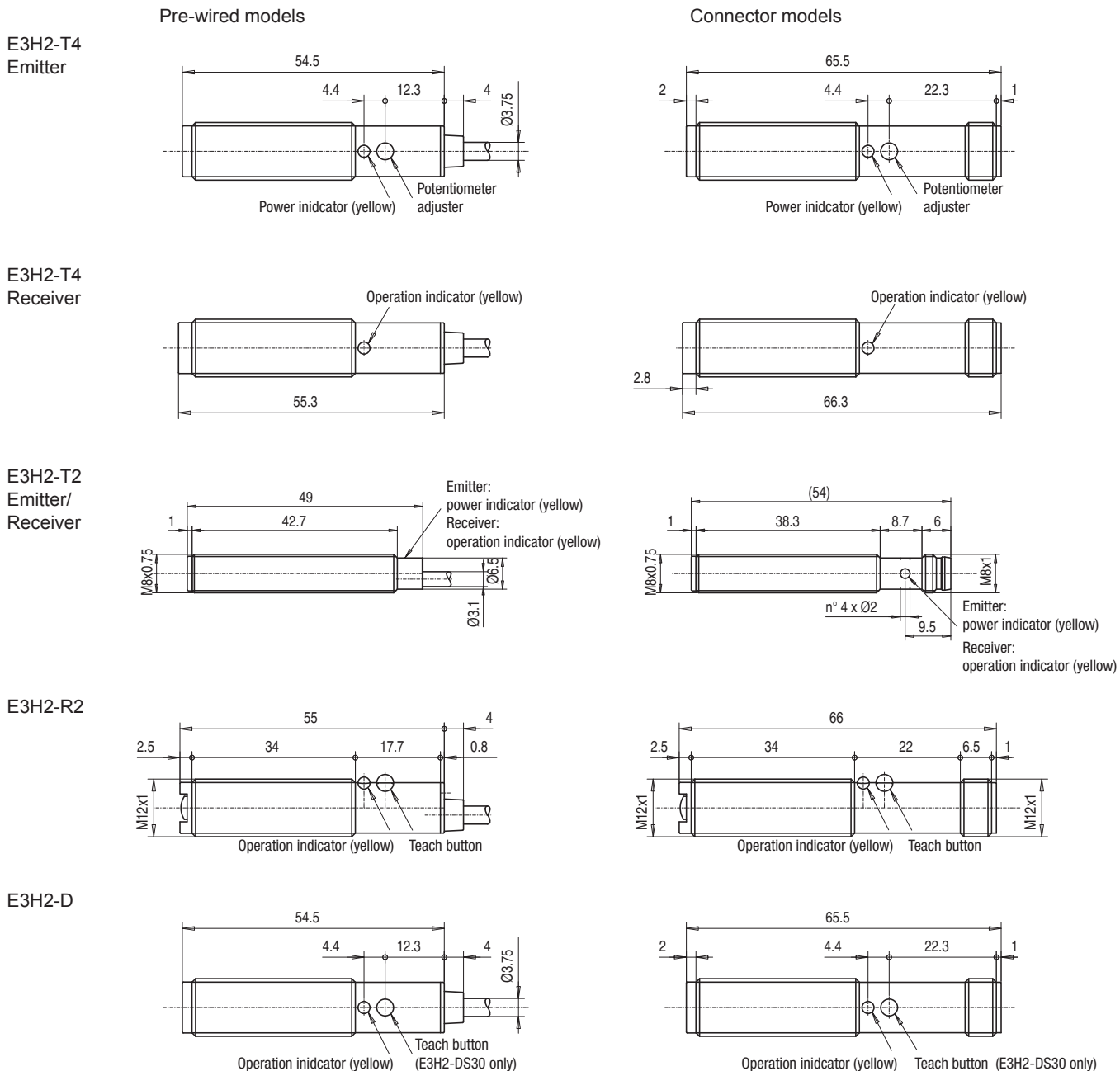

## Safety precautions

### Warning

This product is not designed or rated for directly or indirectly ensuring safety of persons. Do not use it for such a purpose.



### Caution

Do not use the product with voltage in excess of the rated voltage. Excess voltage may result in malfunction or fire.



Never use the product with an AC power supply. Otherwise, explosion may result.



When cleaning the product, do not apply a high-pressure spray of water to one part of the product. Otherwise, parts may become damaged and the degree of protection may be degraded.



High-temperature environments may result in burn injury.



### Precautions for Safe Use

The following precautions must be observed to ensure safe operation of the Sensor.

#### Operating Environment

Do not use the Sensor in an environment where explosive or flammable gas is present.

#### Connecting Connectors

Be sure to hold the connector cover when inserting or removing the connector. Be sure to tighten the connector lock by hand; do not use pliers or other tools. If the tightening is insufficient, the degree of protection will not be maintained and the Sensor may become loose due to vibration. The appropriate tightening torque is 0.4 to 0.5 N·m for M12 connectors and 0.3 Nm for M8 connectors.

#### Load

Do not use a load that exceeds the rated load.

#### Environments with Cleaners and Disinfectants

Do not use the Sensor in environments subject to cleaners and disinfectants. They may reduce the degree of protection.

#### Modifications

Do not attempt to disassemble, repair, or modify the Sensor.

#### Outdoor Use

Do not use the Sensor in locations subject to direct sunlight.

#### Cleaning

Do not use thinner, alcohol, or other organic solvents. Otherwise, the optical properties and degree of protection may be degraded.

#### Surface Temperature

Burn injury may occur. The Sensor surface temperature rises depending on application conditions, such as the surrounding temperature and the power supply voltage. Use caution when operating or washing the Sensor.

### Precautions for Correct Use

Do not use the Sensor in any atmosphere or environment that exceeds the ratings.

#### Do not install the Sensor in the following locations.

- (1) Locations subject to direct sunlight
- (2) Locations subject to condensation due to high humidity
- (3) Locations subject to corrosive gas
- (4) Locations where the Sensor may receive direct vibration or shock

#### Connecting and Mounting

- (1) The maximum power supply voltage is 30 VDC. Before turning the power ON, make sure that the power supply voltage does not exceed the maximum voltage.
- (2) Laying Sensor wiring in the same conduit or duct as high-voltage wires or power lines may result in malfunction or damage due to induction. As a general rule, wire the Sensor in a separate conduit or use shielded cable.
- (3) Use an extension cable with a minimum thickness of 1 mm<sup>2</sup> and less than 100 m long.
- (4) Do not pull on the cable with excessive force.
- (5) Pounding the Photoelectric Sensor with a hammer or other tool during mounting will impair water resistance.
- (6) Mount the Sensor either using the bracket (sold separately) or on a flat surface.
- (7) Be sure to turn OFF the power supply before inserting or removing the connector.

#### Cleaning

Never use thinner or other solvents. Otherwise, the Sensor surface may be dissolved.

#### Power Supply

If a commercial switching regulator is used, ground the FG (frame ground) terminal.

#### Power Supply Reset Time

The Sensor will be able to detect objects 150 ms after the power supply is tuned ON. Start using the Sensor 150 ms or more after turning ON the power supply. If the load and the Sensor are connected to separate power supplies, be sure to turn ON the Sensor first.

#### Turning OFF the Power Supply

Output pulses may be generated even when the power supply is OFF. Therefore, it is recommended to first turn OFF the power supply for the load or the load line.

#### Load Short-circuit Protection

This Sensor is equipped with load short-circuit protection, but be sure to not short circuit the load. Be sure to not use an output current flow that exceeds the rated current.

#### Water Resistance

Do not use the Sensor in water, rainfall, or outdoors.



---

**WARRANTY**

OMRON's exclusive warranty is that the products are free from defects in materials and workmanship for a period of one year (or other period if specified) from date of sale by OMRON.

OMRON MAKES NO WARRANTY OR REPRESENTATION, EXPRESS OR IMPLIED, REGARDING NON-INFRINGEMENT, MERCHANTABILITY, OR FITNESS FOR PARTICULAR PURPOSE OF THE PRODUCTS. ANY BUYER OR USER ACKNOWLEDGES THAT THE BUYER OR USER ALONE HAS DETERMINED THAT THE PRODUCTS WILL SUITABLY MEET THE REQUIREMENTS OF THEIR INTENDED USE. OMRON DISCLAIMS ALL OTHER WARRANTIES, EXPRESS OR IMPLIED.

**LIMITATIONS OF LIABILITY**

OMRON SHALL NOT BE RESPONSIBLE FOR SPECIAL, INDIRECT, OR CONSEQUENTIAL DAMAGES, LOSS OF PROFITS OR COMMERCIAL LOSS IN ANY WAY CONNECTED WITH THE PRODUCTS, WHETHER SUCH CLAIM IS BASED ON CONTRACT, WARRANTY, NEGLIGENCE, OR STRICT LIABILITY.

In no event shall responsibility of OMRON for any act exceed the individual price of the product on which liability is asserted.

IN NO EVENT SHALL OMRON BE RESPONSIBLE FOR WARRANTY, REPAIR, OR OTHER CLAIMS REGARDING THE PRODUCTS UNLESS OMRON'S ANALYSIS CONFIRMS THAT THE PRODUCTS WERE PROPERLY HANDLED, STORED, INSTALLED, AND MAINTAINED AND NOT SUBJECT TO CONTAMINATION, ABUSE, MISUSE, OR INAPPROPRIATE MODIFICATION OR REPAIR.

**SUITABILITY FOR USE**

THE PRODUCTS CONTAINED IN THIS DOCUMENT ARE NOT SAFETY RATED. THEY ARE NOT DESIGNED OR RATED FOR ENSURING SAFETY OF PERSONS, AND SHOULD NOT BE RELIED UPON AS A SAFETY COMPONENT OR PROTECTIVE DEVICE FOR SUCH PURPOSES. Please refer to separate catalogs for OMRON's safety rated products.

OMRON shall not be responsible for conformity with any standards, codes, or regulations that apply to the combination of products in the customer's application or use of the product.

At the customer's request, OMRON will provide applicable third party certification documents identifying ratings and limitations of use that apply to the products. This information by itself is not sufficient for a complete determination of the suitability of the products in combination with the end product, machine, system, or other application or use.

The following are some examples of applications for which particular attention must be given. This is not intended to be an exhaustive list of all possible uses of the products, nor is it intended to imply that the uses listed may be suitable for the products:

- Outdoor use, uses involving potential chemical contamination or electrical interference, or conditions or uses not described in this document.
- Nuclear energy control systems, combustion systems, railroad systems, aviation systems, medical equipment, amusement machines, vehicles, safety equipment, and installations subject to separate industry or government regulations.
- Systems, machines, and equipment that could present a risk to life or property.

Please know and observe all prohibitions of use applicable to the products.

NEVER USE THE PRODUCTS FOR AN APPLICATION INVOLVING SERIOUS RISK TO LIFE OR PROPERTY WITHOUT ENSURING THAT THE SYSTEM AS A WHOLE HAS BEEN DESIGNED TO ADDRESS THE RISKS, AND THAT THE OMRON PRODUCT IS PROPERLY RATED AND INSTALLED FOR THE INTENDED USE WITHIN THE OVERALL EQUIPMENT OR SYSTEM.

**PERFORMANCE DATA**

Performance data given in this document is provided as a guide for the user in determining suitability and does not constitute a warranty. It may represent the result of OMRON's test conditions, and the users must correlate it to actual application requirements. Actual performance is subject to the OMRON Warranty and Limitations of Liability.

**CHANGE IN SPECIFICATIONS**

Product specifications and accessories may be changed at any time based on improvements and other reasons.

It is our practice to change model numbers when published ratings or features are changed, or when significant construction changes are made. However, some specifications of the product may be changed without any notice. When in doubt, special model numbers may be assigned to fix or establish key specifications for your application on your request. Please consult with your OMRON representative at any time to confirm actual specifications of purchased products.

**DIMENSIONS AND WEIGHTS**

Dimensions and weights are nominal and are not to be used for manufacturing purposes, even when tolerances are shown.

**ERRORS AND OMISSIONS**

The information in this document has been carefully checked and is believed to be accurate; however, no responsibility is assumed for clerical, typographical, or proofreading errors, or omissions.

**PROGRAMMABLE PRODUCTS**

OMRON shall not be responsible for the user's programming of a programmable product, or any consequence thereof.

Cat. No. E64E-EN-01B

**In the interest of product improvement, specifications are subject to change without notice.**

---

**OMRON EUROPE B.V.**

Wegalaan 67-69,  
 NL-2132 JD, Hoofddorp,  
 The Netherlands  
 Phone: +31 23 568 13 00  
 Fax: +31 23 568 13 88  
 www.industrial.omron.eu

## X-ON Electronics

Largest Supplier of Electrical and Electronic Components

*Click to view similar products for [Photoelectric Sensors](#) category:*

*Click to view products by [Omron](#) manufacturer:*

Other Similar products are found below :

[7442AD2X5FRX](#) [EX-19B-LP](#) [EX-19SB-PN](#) [7443AR0X5FRX](#) [7452AD4D4NNX](#) [F3WD052C5M](#) [7655AR-04-F-1-2-RX](#) [7694ADE04DS2X](#)  
[FE7C-FRC6S-M](#) [FX-305](#) [PM-R24-R](#) [Q45VR2FPQ](#) [13104RQD07](#) [E3JUXM4MN](#) [E3L2DC4](#) [E3S3LE21](#) [E3SCT11M1J03M](#) [E3SDS20E21](#)  
[E3VDS70C43S](#) [E3XNM16](#) [BR23P](#) [HOA6563-001](#) [OJ-3307-30N8](#) [OS-311A-30](#) [P32013](#) [P34036](#) [P43004](#) [P56001](#) [P60001](#) [PB10CNT15PO](#)  
[S14132](#) [935286-000](#) [S52101](#) [S56258](#) [SH-21E](#) [EX-L261-P](#) [FD-SN500](#) [FE7B-FDRB6-M](#) [SU-79](#) [T36342](#) [T40300](#) [T60001](#) [PD60CNX20BP](#)  
[FX-302-HY](#) [FZS](#) [PM-T64W](#) [PX-22](#) [PZ2-51P](#) [CX-491-P-J](#) [CYNUTX10](#)