

E3S-C

Water- and Oil-resistant Photoelectric Sensor with Metal Housing Used for Long-range Sensing



- Excellent resistance against the water and oil. Easy application in locations with oil mist.
- Long-range sensing up to 30 m with Through-beam models.
- Shock resistance rated at 1,000m/s².
- Product lineup includes metal M12 pre-wired connector models.
- NPN/PNP selector switch output.



Be sure to read *Safety Precautions* on page 7.

For the most recent information on models that have been certified for safety standards, refer to your OMRON website.

Ordering Information

Sensors (Refer to *Dimensions* on page 8.)

Red light Infrared light

Sensing method	Appearance	Connection method	Sensing distance	Model		
Through-beam (Emitter + Receiver) *	Horizontal 	Pre-wired	30 m	E3S-CT11 2M Emitter E3S-CT11-L 2M Receiver E3S-CT11-D 2M		
		Pre-wired Connector (M12)		E3S-CT11-M1J 0.3M Emitter E3S-CT11-L-M1J 0.3M Receiver E3S-CT11-D-M1J 0.3M		
	Vertical 	Pre-wired		E3S-CT61 2M Emitter E3S-CT61-L 2M Receiver E3S-CT61-D 2M		
		Pre-wired Connector (M12)		E3S-CT61-M1J 0.3M Emitter E3S-CT61-L-M1J 0.3M Receiver E3S-CT61-D-M1J 0.3M		
	Retro-reflective	Horizontal 		Pre-wired	3 m	E3S-CR11 2M
				Pre-wired Connector (M12)		E3S-CR11-M1J 0.3M
Vertical 		Pre-wired	E3S-CR61 2M			
		Pre-wired Connector (M12)	E3S-CR61-M1J 0.3M			
Diffuse-reflective	Horizontal 	Pre-wired	700 mm	E3S-CD11 2M		
			2 m	E3S-CD12 2M		
		Pre-wired Connector (M12)	700 mm	E3S-CD11-M1J 0.3M		
			2 m	E3S-CD12-M1J 0.3M		
	Vertical 	Pre-wired	700 mm	E3S-CD61 2M		
			2 m	E3S-CD62 2M		
		Pre-wired Connector (M12)	700 mm	E3S-CD61-M1J 0.3M		
			2 m	E3S-CD62-M1J 0.3M		

* Through-beam Sensors are normally sold in sets that include both the Emitter and Receiver.

Accessories (Order Separately)

Slits (A Slit is not provided with Through-beam Sensors. Order a Slit separately if required.) (Refer to *Dimensions* on page 10.)

Slit width	Sensing distance	Minimum detectable object (reference value)	Model	Quantity	Remarks
0.5 mm × 11 mm	1.8 m	0.5-mm dia.	E39-S61	1 set each for Emitter and Receiver (8 Slits total)	(Snap-in Long Slit) Can be used with the E3S-CT□1(-M1J) Through-beam Sensor. Refer to page 10.
1 mm × 11 mm	3.5 m	1-mm dia.			
2 mm × 11 mm	7 m	2-mm dia.			
4 mm × 11 mm	15 m	2.6-mm dia.			

Reflectors (A Reflector is required for each Retro-reflective Sensor.)

The E39-R1 Reflector is provided with the Sensor. Order other Reflectors separately if required. (Refer to *Dimensions* on E39-L/E39-S/E39-R.)

Name	Sensing distance		Model	Quantity	Remarks
	Rated value	Reference value			
Reflectors	3 m	---	E39-R1	1	Provided with the E3S-CR□1 (-M1J) Retro-reflective Sensor.
	---	4 m	E39-R2	1	---
Small Reflectors	---	1.5 m	E39-R3	1	---
	---	750 mm	E39-R4	1	---
Tape Reflectors	---	700 mm (50 mm)*	E39-RS1	1	Enables MSR function.
	---	1,100 mm (100 mm)*	E39-RS2	1	
	---	1,400 mm (100 mm)*	E39-RS3	1	



Note: 1. If you use any Reflector other than the enclosed Reflector, make sure that the stability indicator lights properly when you set the Sensor.

2. Refer to *Reflectors* on E39-L/E39-S/E39-R for details.

* Values in parentheses indicate the minimum distance required between the Sensor and Reflector.

Mounting Brackets

Some Mounting Brackets are provided with the Sensor. Order other Mounting Brackets separately if required. (Refer to *Dimensions* on E39-L/E39-S/E39-R.)

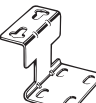
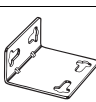
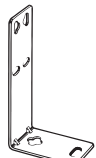

Appearance	Model	Quantity	Remarks
	E39-L102	1	Provided with Horizontal Models.
	E39-L103	1	Provided with Vertical Models.
	E39-L85	1	Mounting bracket for changing from E3S-□□□□□42/44 to E3S-C Vertical Models.
	E39-L86	1	Mounting bracket for changing from E3S-□□□□□43 to E3S-C Vertical Models.
	E39-L87	1	---

Note: 1. When using a Through-beam Sensor, order one Connector for the Receiver and one for the Emitter.

2. Refer to *Mounting Brackets* on E39-L/F39-L/E39-S/E39-R for details.

Sensor I/O Connectors (Sockets on One Cable End)

(Models with Pre-wired Connectors: A Connector is not provided with the Sensor. Be sure to order a Connector separately.) (Refer to *Dimensions* on XS2.)

Cable	Appearance	Cable type	Model
Fire-retardant, robot cable	Straight 	2 m	XS2F-D421-DC0-F
		5 m	XS2F-D421-GC0-F
	L-shape 	2 m	XS2F-D422-DC0-F
		5 m	XS2F-D422-GC0-F

Note: 1. When using a Through-beam Sensor, order one Connector for the Receiver and one for the Emitter.

2. For details on Sensor I/O Connectors and cables such as vibration-proof robot cables, refer to *Introduction to Sensor I/O Connectors/Sensor Controllers*.

Ratings and Specifications

Item	Sensing method	Through-beam	Retro-reflective (with M.S.R. function) *1	Diffuse reflective	
	Model	Horizontal E3S-CT11(-M1J)	Horizontal E3S-CR11(-M1J)	Horizontal E3S-CD11(-M1J)	Horizontal E3S-CD12(-M1J)
		Vertical E3S-CT61(-M1J)	Vertical E3S-CR61(-M1J)	Vertical E3S-CD61(-M1J)	Vertical E3S-CD62(-M1J)
Sensing distance	30 m	3 m (when using E39-R1)	700 mm (300 × 300 mm white paper)	2 m (300 × 300 mm white paper)	
Standard sensing object	Opaque, 15-mm dia. min.	Opaque, 75-mm dia. min.	---		
Differential travel	---		20% max. of sensing distance		
Directional angle	Emitter and Receiver: 3° to 15°	3° to 10°	---		
Light source (wavelength)	Infrared LED (880 nm)	Red LED (700 nm)	Infrared LED (880 nm)		
Power supply voltage	10 to 30 VDC including 10% (p.p) ripple				
Current consumption	50 mA max. (Emitter 25 mA max. Receiver 25 mA max.)	40 mA max.			
Control output	Load power supply voltage: 30 VDC max. Load current: 100 mA max. (Residual voltage: NPN output: 1.2 V max., PNP output: 2.0 V max.) Open controller output (NPN/PNP selectable) Light-ON/Dark-ON selectable				
Protection circuits	Power supply reverse polarity circuit protection, Output short-circuit protection	Power supply reverse polarity protection, Output short-circuit protection, Mutual interference prevention			
Response time	Operate or reset: 1 ms max.			Operate or reset 2 ms max.	
Sensitivity adjustment	One-turn adjuster		Two-turn endless adjuster with an indicator		
Ambient illumination (Receiver side)	Incandescent lamp: 5,000 lx max. Sunlight: 10,000 lx max.				
Ambient temperature range	Operating: -25°C to 55°C, Storage: -40°C to 70°C (with no icing or condensation)				
Ambient humidity range	Operating: 35% to 85%, Storage: 35% to 95% (with no condensation)				
Insulation resistance	20 MΩ min. (at 500 VDC)				
Dielectric strength	1,000 VAC, 50/60 Hz for 1 min				
Vibration resistance	Destruction: 10 to 2,000 Hz, 1.5-mm double amplitude or 300 m/s ² for 0.5 hours each in X, Y, and Z directions				
Shock resistance	Destruction: 1,000 m/s ² 3 times each in X, Y, and Z directions				
Degree of protection	IEC 60529: IP67 (in-house standards: oil-resistant), NEMA: 6P (indoors only) *2				
Connection method	Pre-wired (standard cable length: 2 m) or Pre-wired M12 Connector (standard cable length: 0.3 m)				
Weight (packed state)	Approx. 270 g (Pre-wired cable) Approx. 230 g (Pre-wired Connector (M12))	Approx. 160 g (Pre-wired cable) Approx. 130 g (Pre-wired Connector (M12))	Approx. 150 g (Pre-wired cable) Approx. 110 g (Pre-wired Connector (M12))		
Material	Case	Zinc die-cast			
	Operation panel cover	PES (polyether sulfone)			
	Lens	Methacrylic resin			
	Mounting Bracket	Stainless steel (SUS304)			
Accessories	Mounting Bracket (with screws), Adjustment screwdriver, Instruction manual, and Reflector (only for Retro-reflective Sensors)				

*1. Refer to MSR function of *Technical Guide (Technical version)*.

*2. NEMA: National Electrical Manufacturers Association

Engineering Data (Reference value)

Parallel Operating Range

Through-beam

E3S-CT□ (-M1J)

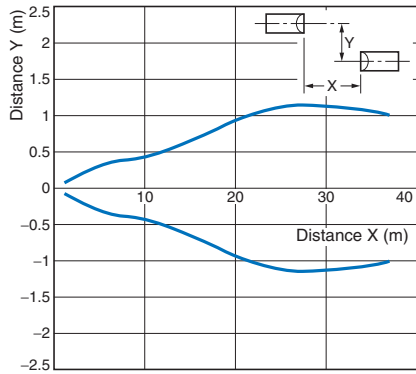

Through-beam

E3S-CT□ (-M1J) + E39-S61 Slit (Order Separately)

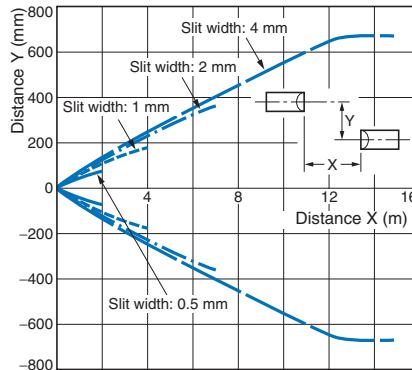

Retro-reflective

E3S-CR□1 (-M1J) + E39-R1 Reflector (Provided)

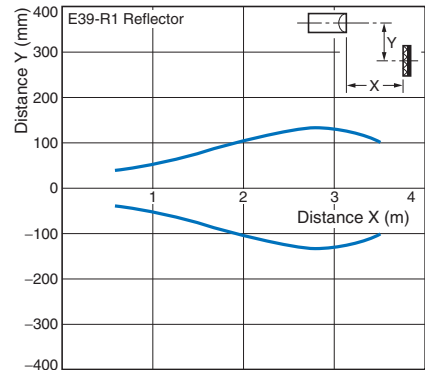

Operating Range

Diffuse-reflective

E3S-CD□□ (-M1J)

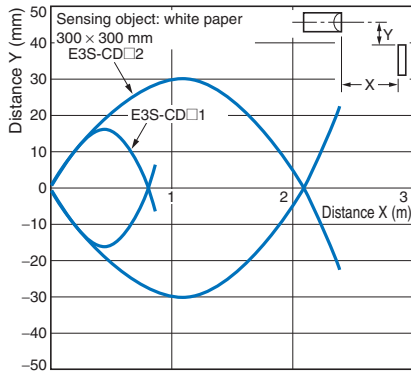

Excess Gain vs. Set Distance

Through-beam

E3S-CT□1 (-M1J)

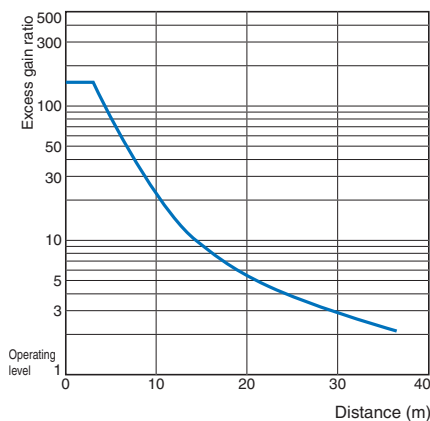

Retro-reflective

E3S-CR□1 (-M1J) + E39-R1 Reflector (Provided)

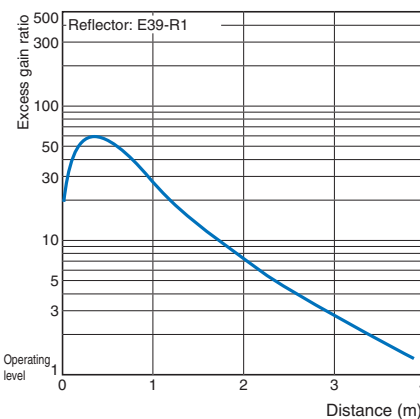

Diffuse-reflective

E3S-CD□□ (-M1J)

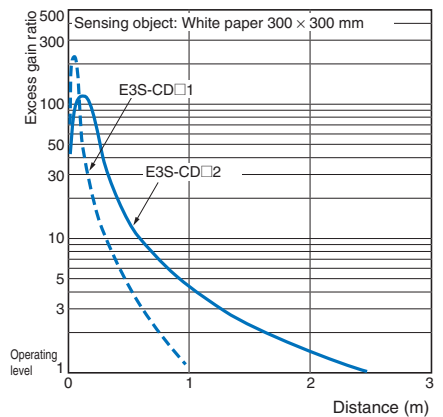

I/O Circuit Diagrams

NPN Output

Model	Operation mode	Timing charts	Operation selector	Output circuits
E3S-CT11(-M1J) * E3S-CT61(-M1J) * E3S-CR11(-M1J) E3S-CR61(-M1J) E3S-CD11(-M1J) E3S-CD12(-M1J) E3S-CD61(-M1J) E3S-CD62(-M1J)	Light-ON	Incident light: [High pulse] No incident light: [Low] Light indicator ON (Red): [High pulse] OFF: [Low] Output transistor: ON [High pulse], OFF [Low] Load Operate (e.g. relay): Operate [High pulse], Reset [Low] (Between brown ① and black ④ leads)	L side (LIGHT ON)	Through-beam Model Receivers: Retro-reflective Models, Reflective Models <p>* Set the NPN or PNP selector to NPN.</p> <p>Connector Pin Arrangement</p> <p>Pin 2 is not used.</p>
	Dark-ON	Incident light: [High pulse] No incident light: [Low] Light indicator ON (Red): [High pulse] OFF: [Low] Output transistor: ON [High pulse], OFF [Low] Load Operate (e.g. relay): Operate [High pulse], Reset [Low] (Between brown ① and black ④ leads)	D side (DARK ON)	Through-beam Model Emitters <p>Connector Pin Arrangement</p> <p>Note: Pins 2 and 4 are not used.</p>

PNP Output

Model	Operation mode	Timing charts	Operation selector	Output circuits
E3S-CT11(-M1J) * E3S-CT61(-M1J) * E3S-CR11(-M1J) E3S-CR61(-M1J) E3S-CD11(-M1J) E3S-CD12(-M1J) E3S-CD61(-M1J) E3S-CD62(-M1J)	Light-ON	Incident light: [High pulse] No incident light: [Low] Light indicator ON (Red): [High pulse] OFF: [Low] Output transistor: ON [High pulse], OFF [Low] Load Operate (e.g. relay): Operate [High pulse], Reset [Low] (Between blue ③ and black ④ leads)	L side (LIGHT ON)	Through-beam Model Receivers: Retro-reflective Models, Reflective Models <p>* Set the NPN or PNP selector to PNP.</p> <p>Connector Pin Arrangement</p> <p>Pin 2 is not used.</p>
	Dark-ON	Incident light: [High pulse] No incident light: [Low] Light indicator ON (Red): [High pulse] OFF: [Low] Output transistor: ON [High pulse], OFF [Low] Load Operate (e.g. relay): Operate [High pulse], Reset [Low] (Between blue ③ and black ④ leads)	D side (DARK ON)	Through-beam Model Emitters <p>Connector Pin Arrangement</p> <p>Note: Pins 2 and 4 are not used.</p>

* Models numbers for Through-beam Sensors (E3S-CT11(-M1J)) are for sets that include both the Emitter and Receiver. The model number of the Emitter is expressed by adding "-L" to the set model number (example: E3S-CT11-L 2M), the model number of the Receiver, by adding "-D" (example: E3S-CT11-D 2M.) Refer to *Ordering Information* to confirm model numbers for Emitter and Receivers.

Plug (Sensor I/O Connector)

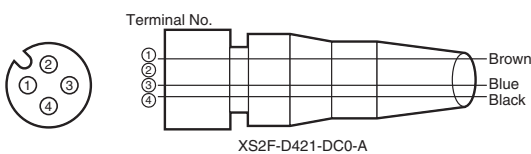

Classification	Conductor	Connector pin No.	Application
DC	Brown	1	Power supply (+V)
	—	2	—
	Blue	3	Power supply (0 V)
	Black	4	Output

Note: Pin 2 is not used.

Refer to *Introduction to Sensor I/O Connectors/Sensor Controllers* for details.

Nomenclature

Horizontal Model

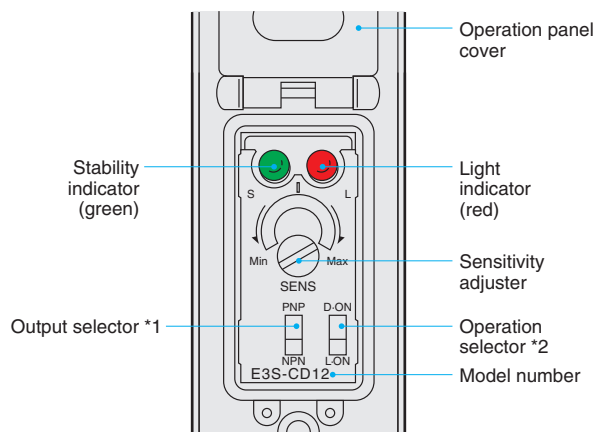

Vertical Model

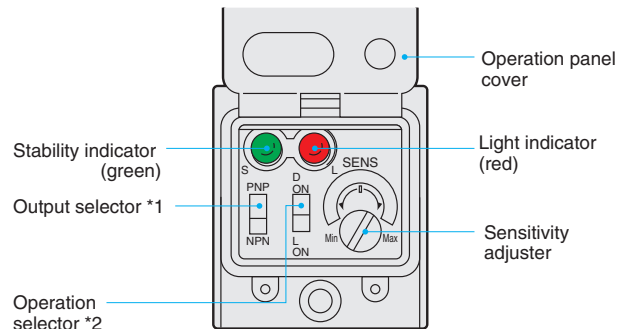

Note: The sensitivity adjuster on Through-beam and Retro-reflective Models is different.

*1. Use the output selector to select the type of output transistor, NPN or PNP.

*2. Use the operation selector to select the operation mode.

Safety Precautions

Refer to *Warranty and Limitations of Liability*.

⚠ WARNING

This product is not designed or rated for ensuring safety of persons either directly or indirectly. Do not use it for such purposes.



Precautions for Correct Use

Do not use the product in atmospheres or environments that exceed product ratings.

● Wiring

Cable

- The E3S-C uses an oil-resistive cable to ensure oil resistivity.
- Do not allow the cable to be bent to a radius of less than 25 mm.

● Mounting

Mounting

- When mounting the E3S-C, do not hit the E3S-C with a hammer, or the E3S-C will lose watertightness.
- Use M4 screws to mount the E3S-C. The tightening torque of each screw must be 1.18 N·m maximum.

Mounting Bracket

- When mounting the E3S-C with the mounting bracket so that sensing objects will be in the direction of the mechanical axis, use the optical axis lock holes.
- If it is not possible to mount the E3S-C so that the sensing objects will be in the direction of the mechanical axis, move the E3S-C upwards, downwards, to the left, or to the right and secure the E3S-C in the center of the range where the light indicator will be lit, at which time make sure that the stability indicator is lit.

Direct Mounting

Mount the E3S-C as shown in the following illustration.

Mounting with M4 Screws

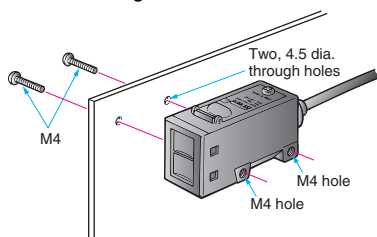

Mounting with M3 Screws

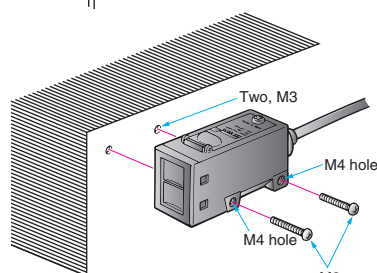

Optical Axis Adjustment

Optical Lock Holes

By inserting screws into the optical axis lock holes, the Mounting Bracket will be in the direction of the optical axis of the E3S-C.

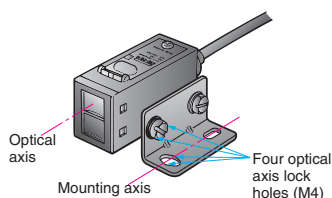

● Adjusting

Optical Axis of Through-beam Sensor

The E3S-C Through-beam Models incorporates two lenses, one of which will be used as shown in the following illustration. When using a Slit, the Slit must be on the side where the lens to be used is located.

Horizontal Model

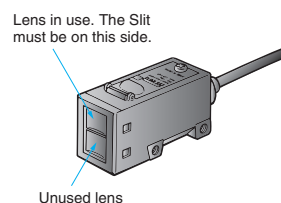

Vertical Model

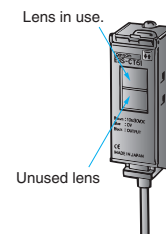

Water Resistance

To ensure the water resistance of the E3S-C, tighten the screws of the operation panel cover to a torque of 0.34 N·m to 0.54 N·m.

● Others

Oil and Chemical Resistance

- Although the E3S-C is oil-resistance, refer to the following table before using the E3S-C in places where oil may be sprayed on the E3S-C.
- Tests were carried out with the following oils and it was certified that the E3S-C resists these oils.

Oil	Product name	Kinematic viscosity (mm ² /s (cst)) at 40°C	PH
Lubricating oil	Velocite No.3 (manufactured by Exxon Mobil)	2.02	---
Water insoluble machining oil	Yushiron Oil No. 2 ac (manufactured by Yushiro Chemical Industry Co., Ltd.)	Less than 10	
Water soluble machining oil	Yushiroken EC50T-3 (manufactured by Yushiro Chemical Industry Co., Ltd.)	---	7 to 9.5
	Yushiron Lubic HWC68 (manufactured by Yushiro Chemical Industry Co., Ltd.)		7 to 9.9
	Griton 1700D (manufactured by Toho Chemical Industry Co., Ltd.)		7 to 9.2
	Yushiroken S50N (manufactured by Yushiro Chemical Industry Co., Ltd.)		7 to 9.8

Note: 1. The E3S-C maintained a minimum insulation resistance of 100 MΩ after the E3S-C was dipped in all the above oils at a temperature of 50°C for 240 hours.

2. When using the E3S-C in a place where an oil other than the ones listed above is sprayed on the E3S-C, refer to the above kinematic viscosity and pH values. The location may be suitable for the E3S-C if the kinematic viscosity and pH values of the oil are close to the above kinematic viscosity and pH values, but make sure that the oil does not contain any additive that may have a negative influence on the E3S-C.

Through-beam (Vertical)
E3S-CT61(-MJ)

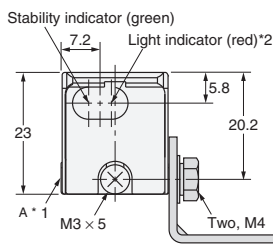
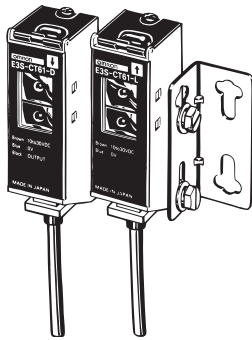

- *1. The Mounting Bracket can be attached to side A.
- *2. The Emitters for Through-beam Sensors only have the power indicator (red).
- *3. The Emitter cable is 4-dia.vinyl-insulated round cable with 2 conductors (conductor cross section: 0.3 mm², insulator diameter: 1.3 mm) and a standard length of 2 m.

Pre-wired Connector (-M1J)

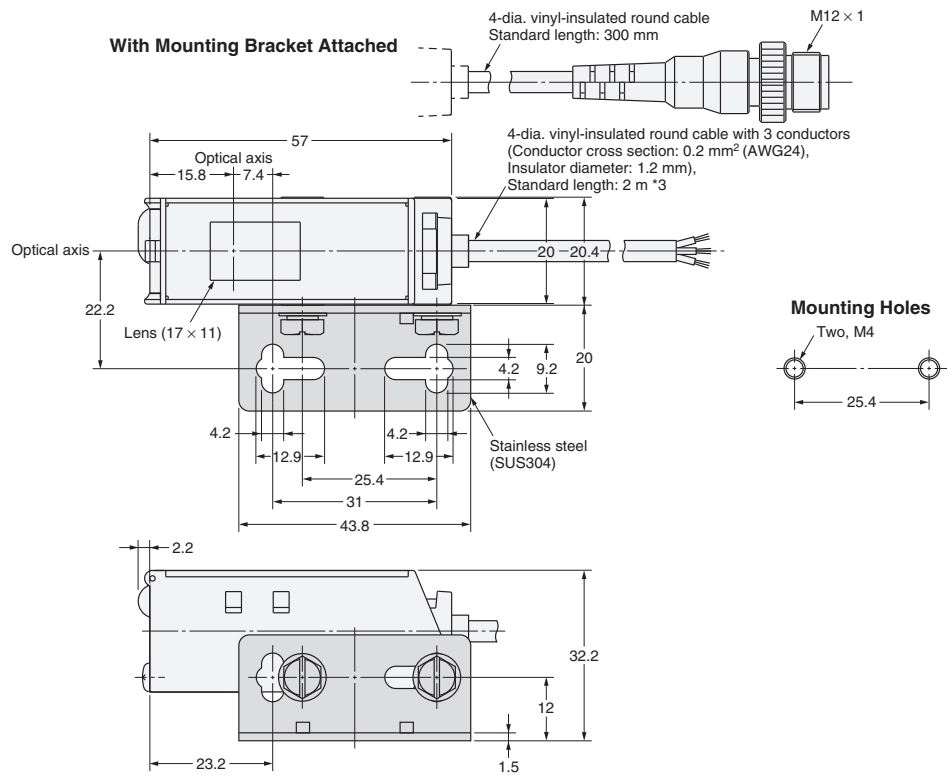

Retro-Diffuse-reflective (Horizontal)
E3S-CR11(-M1J)
E3S-CD11(-M1J)
E3S-CD12(-M1J)

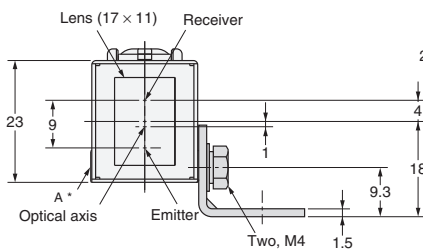
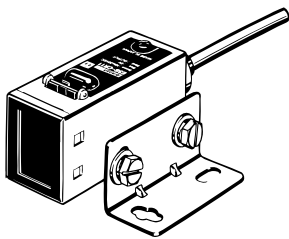

*The Mounting Bracket can be attached to side A.

Pre-wired Connector (-M1J)

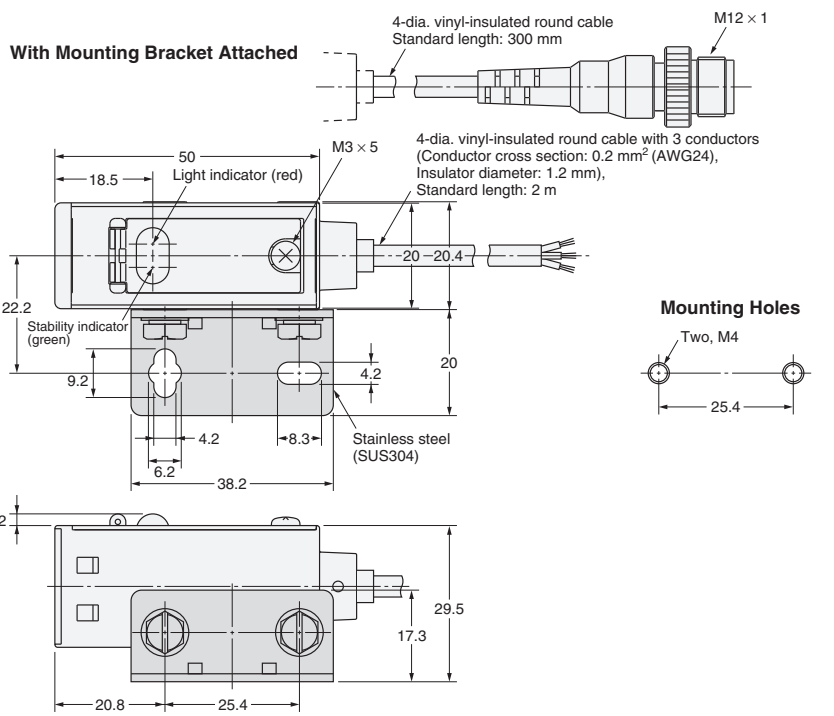

Note: Model numbers for Through-beam Sensors (E3S-CT61(-M1J)) are for sets that include both the Emitter and Receiver. The model number of the Emitter is expressed by adding "-L" to the set model number (example: E3S-CT61-L 2M), the model number of the Receiver, by adding "-D" (example: E3S-CT61-D 2M.) Refer to *Ordering Information* to confirm model numbers for Emitter and Receivers.

Retro-/Diffuse-reflective (Vertical)

E3S-CR61(-M1J)
E3S-CD61(-M1J)
E3S-CD62(-M1J)

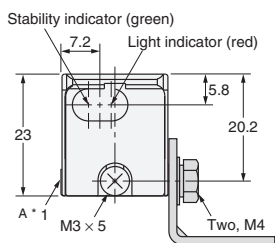
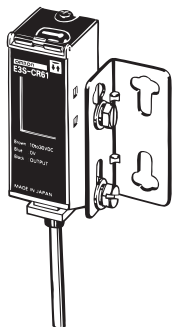

*The Mounting Bracket can be attached to side A.

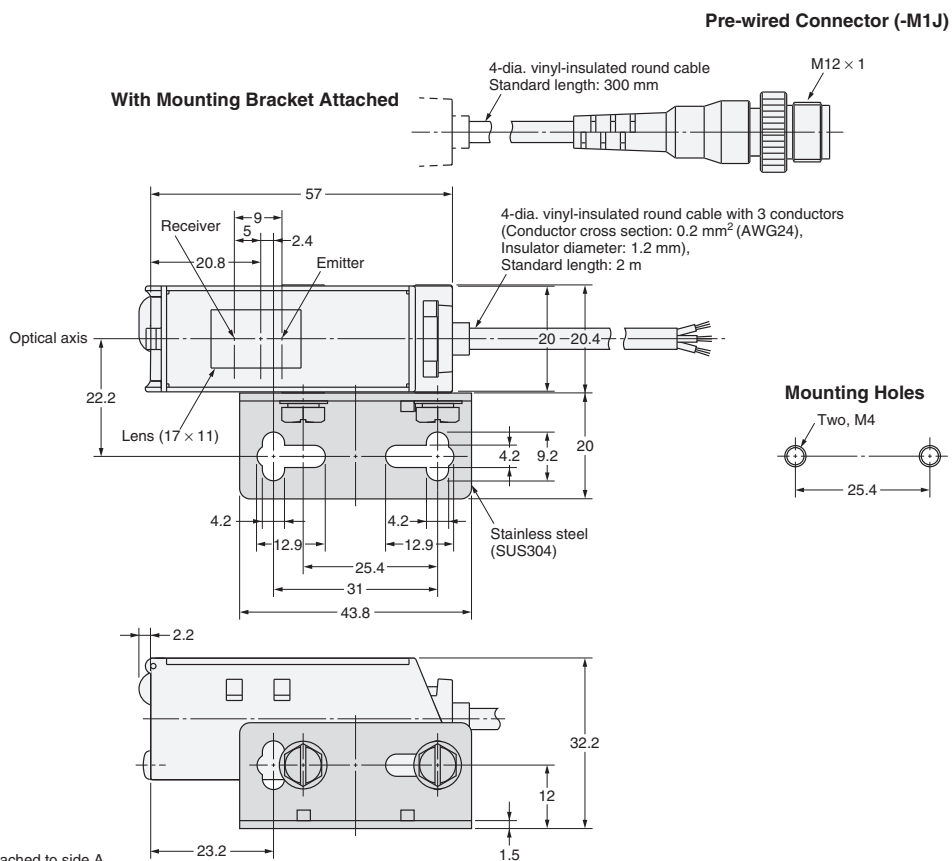

Accessories (Order Separately)

Snap-in Long Slit (For Through-beam Models)
E39-S61

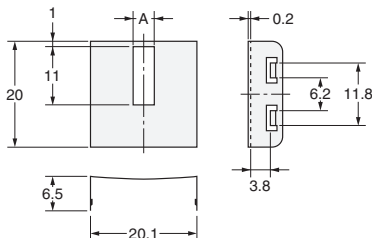
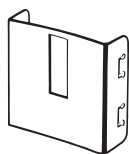

Dimension A (mm)	Material	Quantity
0.5	Stainless steel	1 set each for Emitter/Receiver (8 Slits total)
1		
2		
4		

Reflectors

Refer to E39-L/E39-S/E39-R for details.

Mounting Brackets

Refer to E39-L/E39-S/E39-R for details.

Terms and Conditions Agreement

Read and understand this catalog.

Please read and understand this catalog before purchasing the products. Please consult your OMRON representative if you have any questions or comments.

Warranties.

(a) Exclusive Warranty. Omron's exclusive warranty is that the Products will be free from defects in materials and workmanship for a period of twelve months from the date of sale by Omron (or such other period expressed in writing by Omron). Omron disclaims all other warranties, express or implied.

(b) Limitations. OMRON MAKES NO WARRANTY OR REPRESENTATION, EXPRESS OR IMPLIED, ABOUT NON-INFRINGEMENT, MERCHANTABILITY OR FITNESS FOR A PARTICULAR PURPOSE OF THE PRODUCTS. BUYER ACKNOWLEDGES THAT IT ALONE HAS DETERMINED THAT THE PRODUCTS WILL SUITABLY MEET THE REQUIREMENTS OF THEIR INTENDED USE.

Omron further disclaims all warranties and responsibility of any type for claims or expenses based on infringement by the Products or otherwise of any intellectual property right. (c) Buyer Remedy. Omron's sole obligation hereunder shall be, at Omron's election, to (i) replace (in the form originally shipped with Buyer responsible for labor charges for removal or replacement thereof) the non-complying Product, (ii) repair the non-complying Product, or (iii) repay or credit Buyer an amount equal to the purchase price of the non-complying Product; provided that in no event shall Omron be responsible for warranty, repair, indemnity or any other claims or expenses regarding the Products unless Omron's analysis confirms that the Products were properly handled, stored, installed and maintained and not subject to contamination, abuse, misuse or inappropriate modification. Return of any Products by Buyer must be approved in writing by Omron before shipment. Omron Companies shall not be liable for the suitability or unsuitability or the results from the use of Products in combination with any electrical or electronic components, circuits, system assemblies or any other materials or substances or environments. Any advice, recommendations or information given orally or in writing, are not to be construed as an amendment or addition to the above warranty.

See <http://www.omron.com/global/> or contact your Omron representative for published information.

Limitation on Liability; Etc.

OMRON COMPANIES SHALL NOT BE LIABLE FOR SPECIAL, INDIRECT, INCIDENTAL, OR CONSEQUENTIAL DAMAGES, LOSS OF PROFITS OR PRODUCTION OR COMMERCIAL LOSS IN ANY WAY CONNECTED WITH THE PRODUCTS, WHETHER SUCH CLAIM IS BASED IN CONTRACT, WARRANTY, NEGLIGENCE OR STRICT LIABILITY.

Further, in no event shall liability of Omron Companies exceed the individual price of the Product on which liability is asserted.

Suitability of Use.

Omron Companies shall not be responsible for conformity with any standards, codes or regulations which apply to the combination of the Product in the Buyer's application or use of the Product. At Buyer's request, Omron will provide applicable third party certification documents identifying ratings and limitations of use which apply to the Product. This information by itself is not sufficient for a complete determination of the suitability of the Product in combination with the end product, machine, system, or other application or use. Buyer shall be solely responsible for determining appropriateness of the particular Product with respect to Buyer's application, product or system. Buyer shall take application responsibility in all cases.

NEVER USE THE PRODUCT FOR AN APPLICATION INVOLVING SERIOUS RISK TO LIFE OR PROPERTY OR IN LARGE QUANTITIES WITHOUT ENSURING THAT THE SYSTEM AS A WHOLE HAS BEEN DESIGNED TO ADDRESS THE RISKS, AND THAT THE OMRON PRODUCT(S) IS PROPERLY RATED AND INSTALLED FOR THE INTENDED USE WITHIN THE OVERALL EQUIPMENT OR SYSTEM.

Programmable Products.

Omron Companies shall not be responsible for the user's programming of a programmable Product, or any consequence thereof.

Performance Data.

Data presented in Omron Company websites, catalogs and other materials is provided as a guide for the user in determining suitability and does not constitute a warranty. It may represent the result of Omron's test conditions, and the user must correlate it to actual application requirements. Actual performance is subject to the Omron's Warranty and Limitations of Liability.

Change in Specifications.

Product specifications and accessories may be changed at any time based on improvements and other reasons. It is our practice to change part numbers when published ratings or features are changed, or when significant construction changes are made. However, some specifications of the Product may be changed without any notice. When in doubt, special part numbers may be assigned to fix or establish key specifications for your application. Please consult with your Omron's representative at any time to confirm actual specifications of purchased Product.

Errors and Omissions.

Information presented by Omron Companies has been checked and is believed to be accurate; however, no responsibility is assumed for clerical, typographical or proofreading errors or omissions.

2015.4

In the interest of product improvement, specifications are subject to change without notice.

OMRON Corporation
Industrial Automation Company

<http://www.ia.omron.com/>

(c)Copyright OMRON Corporation 2015 All Right Reserved.

X-ON Electronics

Largest Supplier of Electrical and Electronic Components

Click to view similar products for [Photoelectric Sensors](#) category:

Click to view products by [Omron](#) manufacturer:

Other Similar products are found below :

[7442AD2X5FRX](#) [EX-19B-LP](#) [EX-19SB-PN](#) [7443AR0X5FRX](#) [7452AD4D4NNX](#) [F3WD052C5M](#) [7655AR-04-F-1-2-RX](#) [7694ADE04DS2X](#)
[FE7C-FRC6S-M](#) [FX-305](#) [PM-R24-R](#) [Q45VR2FPQ](#) [13104RQD07](#) [E3JUXM4MN](#) [E3L2DC4](#) [E3S3LE21](#) [E3SCT11M1J03M](#) [E3SDS20E21](#)
[E3VDS70C43S](#) [E3XNM16](#) [BR23P](#) [HOA6563-001](#) [OJ-3307-30N8](#) [OS-311A-30](#) [P32013](#) [P34036](#) [P43004](#) [P56001](#) [P60001](#) [PB10CNT15PO](#)
[S14132](#) [935286-000](#) [S52101](#) [S56258](#) [SH-21E](#) [EX-L261-P](#) [FD-SN500](#) [FE7B-FDRB6-M](#) [SU-79](#) [T36342](#) [T40300](#) [T60001](#) [PD60CNX20BP](#)
[FX-302-HY](#) [FZS](#) [PM-T64W](#) [PX-22](#) [PZ2-51P](#) [CX-491-P-J](#) [CYNUTX10](#)