



Advanced Fiber Sensors

- Features a Power Tuning function that optimizes light reception at the press of a button.
- APC circuits to suppress LED aging degradation used with 4-element LEDs.
- 2-channel models achieve the thinnest* profile in the industry, at only 5 mm per channel.
- 2-channel models also offer AND/OR control output.
- The E3X-MDA0 with two channels supports an EtherCAT Communications Unit or CompoNet Communications Unit.

* (Based on July 2012 OMRON investigation.)



Be sure to read *Safety Precautions* on page 14.

For the most recent information on models that have been certified for safety standards, refer to your OMRON website.

Features

Models available for a wide variety of applications at manufacturing sites

Industry Leading Two Amplifiers Loaded in a Small Body ···· 2-channel models

Two amplifiers are loaded in a 10 mm-wide body. Space usability can be approximately doubled. In addition, approximately 40% of the energy can be saved. (compared to the value per channel of the former model)



High-speed and High-resolution Analog Output Supports Wide Variety of Applications ···· Advanced Analog Output Models

Analog Control Output

The voltage in the range of 1 to 5 V is output according to the incident level (digital display). Wide variety of applications is possible including positioning control or difference detection with multiple levels.

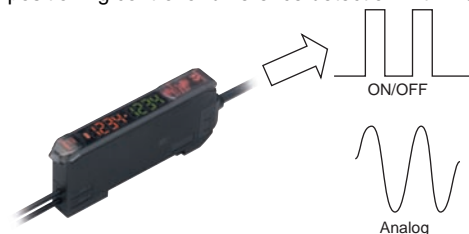

High-speed and High Resolution

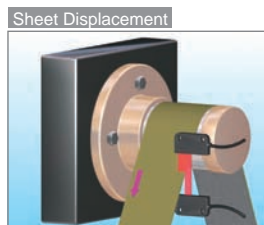

Detection modes can be switched in accordance with applications. High-speed response of 80 μs (super-high-speed mode) supports the positioning controls that require high-speed control.





Ordering Information

Amplifier Units

Amplifier Units with Cables (2 m) [Refer to Dimensions on page 16.]

| Item | Appearance | Functions | Model | | |
|---|---|---|---|-----------------|-----------------|
| | | | NPN output | PNP output | |
| Single-function models |  | --- | E3X-DA11SE-S 2M | E3X-DA41SE-S 2M | |
| Standard models | | | E3X-DA11-S 2M | E3X-DA41-S 2M | |
| Mark-detecting models (multiple color light sources) | | Green LED | Timer, Response speed change | E3X-DAG11-S 2M | E3X-DAG41-S 2M |
| | | Blue LED | | E3X-DAB11-S 2M | E3X-DAB41-S 2M |
| | | Infrared LED | | E3X-DAH11-S 2M | E3X-DAH41-S 2M |
| Advanced models | | External-input models | Remote setting, counter, differential operation | E3X-DA11RM-S 2M | E3X-DA41RM-S 2M |
| | | Twin-output models | Area output, self-diagnosis, differential operation | E3X-DA11TW-S 2M | E3X-DA41TW-S 2M |
| | | ATC function models | ATC (Threshold value automatic correction) | E3X-DA11AT-S 2M | E3X-DA41AT-S 2M |
| | | Analog output models | Analog output models | E3X-DA11AN-S 2M | E3X-DA41AN-S 2M |
| 2-channel models | |  | AND/OR output | E3X-MDA11 2M | E3X-MDA41 2M |

Amplifier Units with Wire-saving Connectors [Refer to Dimensions on page 17.]

| Item | Appearance | Functions | Model | | |
|---|---|---|---|-------------|-------------|
| | | | NPN output | PNP output | |
| Single-function models |  | --- | E3X-DA6SE-S | E3X-DA8SE-S | |
| Standard models | | | E3X-DA6-S | E3X-DA8-S | |
| Mark-detecting models (multiple color light sources) | | Green LED | Timer, Response speed change | E3X-DAG6-S | E3X-DAG8-S |
| | | Blue LED | | E3X-DAB6-S | E3X-DAB8-S |
| | | Infrared LED | | E3X-DAH6-S | E3X-DAH8-S |
| Advanced models | | External-input models | Remote setting, counter, differential operation | E3X-DA6RM-S | E3X-DA8RM-S |
| | | Twin-output models | Area output, self-diagnosis, differential operation | E3X-DA6TW-S | E3X-DA8TW-S |
| | | ATC function models | ATC (Threshold value automatic correction) | E3X-DA6AT-S | E3X-DA8AT-S |
| 2-channel models | |  | AND/OR output | E3X-MDA6 | E3X-MDA8 |

Amplifier Units with Connectors for EtherCAT or CompoNet Communications Units [Refer to Dimensions on page 18.]

| Item | Appearance | Functions | Model |
|-----------------|---|---------------|----------|
| 2-channel model |  | AND/OR output | E3X-MDA0 |

Ratings and Specifications

| Type | Light source | Response time | Control output/input | | | Functions | | | | | | | | | | | |
|------------------------|--------------------|----------------------|-----------------------------------|----------|---------------|--------------|-------|-------------------------|------------------------|---------|-----|---------|----------------------|---|---|---|-----|
| | | | ON/OFF output | Input | Analog output | Power tuning | Timer | Interference prevention | Differential detection | counter | ATC | | | | | | |
| Single-function models | Red LED | 1 ms | Only main | --- | --- | --- | --- | ○ | --- | --- | --- | | | | | | |
| Standard models | | 50 μs to 4 ms | | | | ○ | ○ | | | | | | | | | | |
| Mark-detecting models | E3X-DA□G-S | 50 μs to 4 ms | Only main | --- | --- | ○ | ○ | ○ | --- | --- | --- | | | | | | |
| | 3X-DA□B-S | | | | | | | | | | | Red LED | Main + sub (2 lines) | ○ | ○ | ○ | --- |
| | E3X-DA□H-S | | | | | | | | | | | | | | | | |
| Advanced models | Twin-output models | 50 μs to 4 ms | Only main | (1 line) | ○ | ○ | ○ | ○ | --- | | | | | | | | |
| External-input models | 80 μs to 4 ms | Main + sub (2 lines) | --- | ○ | | | | | | ○ | ○ | ○ | --- | | | | |
| ATC function models | 130 μs to 4 ms | --- | --- | ○ | ○ | ○ | ○ | --- | | | | | | | | | |
| Analog output | 80 μs to 4 ms | Only main | --- | (1 line) | --- | --- | --- | --- | | | | | | | | | |
| 2-channel models | Red LED | 130 μs to 4 ms | Main + main (2 independent lines) | --- | --- | ○ | ○ | ○ | --- | --- | --- | | | | | | |

Amplifier Unit Connectors (Order Separately)

Note: Protector seals are provided as accessories. [Refer to *Dimensions* on page 18.]

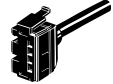
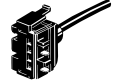
| Item | Appearance | Cable length | No. of conductors | Model |
|------------------|---|--------------|-------------------|----------|
| Master Connector |  | 2 m | 3 | E3X-CN11 |
| | | | 4 | E3X-CN21 |
| Slave Connector |  | | 1 | E3X-CN12 |
| | | | 2 | E3X-CN22 |

Ordering Precaution for Amplifier Units with Wire-saving Connectors





Amplifier Units and Connectors are sold separately. Refer to the following tables when placing an order.

| Amplifier Unit | | | Applicable Connector (Order Separately) | |
|---|-------------|-------------|---|-----------------|
| Model | NPN output | PNP output | Master Connector | Slave Connector |
| Single-function models | E3X-DA6SE-S | E3X-DA8SE-S | E3X-CN11 | E3X-CN12 |
| Standard models | E3X-DA6-S | E3X-DA8-S | | |
| Mark-detecting models (multiple color light sources) | E3X-DAG6-S | E3X-DAG8-S | | |
| | E3X-DAB6-S | E3X-DAB8-S | | |
| | E3X-DAH6-S | E3X-DAH8-S | | |
| Advanced models | E3X-DA6TW-S | E3X-DA8TW-S | E3X-CN21 | E3X-CN22 |
| | E3X-DA6RM-S | E3X-DA8RM-S | | |
| | E3X-DA6AT-S | E3X-DA8AT-S | | |
| 2-channel models | E3X-MDA6 | E3X-MDA8 | | |

When Using 5 Amplifier Units

| | | |
|---------------------------|---|---|
| Amplifier Units (5 Units) | + | 1 Master Connector + 4 Slave Connectors |
|---------------------------|---|---|

Mobile Console (Order Separately) [Refer to *Dimensions* on page 19.]

| Appearance | Model | Remarks |
|---|---------------------------------------|---|
|  | E3X-MC11-SV2 (model number of set) | Mobile Console with Head, Cable, and AC adapter provided as accessories |
|  | E3X-MC11-C1-SV2 | Mobile Console |
|  | E3X-MC11-H1 | Head |
|  | E39-Z12-1 | Cable (1.5 m) |

Note: Use the E3X-MC11-SV2 Mobile Console for the E3X-DA-S/MDA-series Amplifier Units.

The E3X-MC11-SV2 is an upgraded version of the E3X-MC11-S that is fully interchangeable with the older model.

Accessories (Order Separately)

Mounting Bracket [Refer to *E39-L/E39-S/E39-R*.]

| Appearance | Model | Quantity |
|---|----------|----------|
|  | E39-L143 | 1 |

End Plate [Refer to *PFP-□*.]

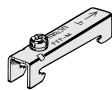
| Appearance | Model | Quantity |
|---|-------|----------|
|  | PFP-M | 1 |

Ratings and Specifications

Refer to pages 16 to 19 for dimensions.

Amplifier Units

● Single-function, Standard, and Mark-detecting Amplifier Units

| Item | Type | Single-function models | Standard models | Mark-detecting models (multiple color light sources) | | |
|--------------------------------------|--|---|--|--|------------------------|----------------------------|
| | Model | E3X-DA□SE-S | E3X-DA□-S | Green LED E3X-DAG□-S | Blue LED E3X-DAB□-S | Infrared LED E3X-DAH□-S |
| Light source (wavelength) | Red LED (635 nm) | | Green LED (525 nm) | | Blue LED (470 nm) | Infrared LED (870nm) |
| Power supply voltage | 12 to 24 VDC ±10%, ripple (p-p) 10% max. | | | | | |
| Power consumption | 960 mW max. (current consumption: 40 mA max. at power supply voltage of 24 VDC) | | | | | |
| Control output | Load power supply voltage: 26.4 VDC; NPN/PNP open collector; load current: 50 mA max.; residual voltage: 1 V max. | | | | | |
| Remote control input | No-voltage input (contact/non-contact) | | --- | | | |
| Protection circuits | Reverse polarity for power supply connection, output short-circuit | | | | | |
| Re-sponse time | Super-high-speed mode | --- | Operate: 48 μs, reset: 50 μs *1,*2 | | | |
| | High-speed mode | --- | Operate/reset: 250 μs | | | |
| | Standard mode | Operate or reset: 1 ms | | | | |
| | High-resolution mode | --- | Operate or reset: 4 ms | | | |
| Sensitivity setting | Teaching or manual method | | | | | |
| Func-tions | Power tuning | --- | Light emission power and reception gain, digital control method | | | |
| | Timer function | --- | Select from OFF-delay, ON-delay, or one-shot timer. 1 ms to 5 s (1 to 20 ms set in 1-ms increments, 20 to 200 ms set in 10-ms increments, 200 ms to 1 s set in 100-ms increments, and 1 to 5 s set in 1 s-increments) | | | |
| | Automatic power control (APC) | High-speed control method for emission current | | | | |
| | Zero-reset | --- | Negative values can be displayed. (Threshold value is shifted.) | | | |
| | Initial reset | Settings can be returned to defaults as required. | | | | |
| | Mutual interference prevention | Possible for up to 10 Units *3 | | | | |
| Display | Operation indicator (orange) | | Operation indicator (orange), Power Tuning indicator (orange) | | | |
| Digital display | incident level + threshold | | Select from incident level + threshold or other 6 patterns | | | |
| Display orientation | --- | | Switching between normal/reversed display is possible. | | | |
| Ambient illumination (Receiver side) | Incandescent lamp: 10,000 lux max. Sunlight: 20,000 lux max. | | | | | |
| Ambient temperature range | Operating: Groups of 1 to 2 Amplifiers: -25°C to 55°C Groups of 3 to 10 Amplifiers: -25°C to 50°C Groups of 11 to 16 Amplifiers: -25°C to 45°C Storage: -30°C to 70°C (with no icing or condensation) | | | | | |
| Ambient humidity range | Operating and storage: 35% to 85% (with no condensation) | | | | | |
| Insulation resistance | 20 MΩ min. (at 500 VDC) | | | | | |
| Dielectric strength | 1,000 VAC at 50/60 Hz for 1 minute | | | | | |
| Vibration resistance | Destruction: 10 to 55 Hz with a 1.5-mm double amplitude for 2 hrs each in X, Y and Z directions | | | | | |
| Shock resistance | Destruction: 500 m/s ² , for 3 times each in X, Y and Z directions | | | | | |
| Degree of protection | IEC 60529 IP50 (with Protective Cover attached) | | | | | |
| Connection method | Pre-wired or amplifier unit connector | | | | | |
| Weight (packed state) | Pre-wired model: Approx. 100 g, Amplifier unit connector model: Approx. 55 g | | | | | |
| Materials | Case | Polybutylene terephthalate (PBT) | | | | |
| | Cover | Polycarbonate (PC) | | | | |
| Accessories | Instruction manual | | | | | |

*1. Communications are disabled if the detection mode is selected during super-high-speed mode, and the communications functions for mutual interference prevention and the Mobile Console will not function.

*2. PNP output is as follows: Operate: 53 μs, reset: 55 μs.

*3. Mutual interference prevention can be used for only up to 6 Units if power tuning is enabled.

● Advanced and 2-channel Amplifier Units

| Item | Type Model | Advanced models | | | | 2-channel models ^{*1} | |
|---------------------------|---|--|--|---|---|---|--|
| | | External input models | Twin output models | ATC function models | Analog output models | Standard models | Model for Communications Unit |
| | | E3X-DA□RM-S | E3X-DA□TW-S | E3X-DA□AT-S | E3X-DA□AN-S | E3X-MDA□ (□: 11/41/6/8) | E3X-MDA0 |
| Light source (wavelength) | | Red LED (635 nm) | | | | | |
| Power supply voltage | | 12 to 24 VDC ±10%, ripple (p-p) 10% max. | | | | | |
| Power consumption | | 1,080 mW max. (current consumption: 45 mA max. at power supply voltage of 24 VDC) | | | | | |
| Control output | ON/OFF output | Load power supply voltage: 26.4 VDC; NPN/PNP open collector; load current: 50 mA max.; residual voltage: 1 V max. | | | | | --- |
| | Analog output | --- | | | Control output Voltage output: 1 to 5 VDC (Connection load 10 kΩ min.) Temperature characteristics 0.3%F.S./°C Response speed/repeat accuracy Super-high-speed mode: 80 μs/1.5%F.S. High-speed mode: 250 μs/1.5%F.S. Standard mode: 1 ms/1%F.S. High-resolution mode: 4 ms/0.75%F.S. | --- | |
| Remote control input | | No-voltage input (contact/transistor) ^{*2} | --- | | | | |
| Protection circuits | | Reverse polarity for power supply connection, output short-circuit | | | | | |
| Response time | Super-high-speed mode | Operate: 48 μs, reset: 50 μs ^{*3, *4} | Operate or reset: 80 μs ^{*3} | Operate or reset: 130 μs ^{*3} | Operate or reset: 80 μs ^{*3} | Operate or reset: 130 μs ^{*3, *6} | --- |
| | High-speed mode | Operate or reset: 250 μs | | | | | Operate or reset: 450 μs |
| | Standard mode | Operate or reset: 1ms | | | | | |
| | High-resolution mode | Operate or reset: 4ms | | | | | |
| Sensitivity setting | | Teaching or manual method | | | | | |
| Functions | Power tuning | Light emission power and reception gain, digital control method | | | | | |
| | Differential detection | Switchable between single edge and double edge detection mode Single edge: Can be set to 250 μs, 500 μs, 1 ms, 10 ms, or 100 ms. Double edge: Can be set to 500 μs, 1 ms, 2 ms, 20 ms, or 200 ms. | | | | --- | |
| | Timer function | Select from OFF-delay, ON-delay, or one-shot timer. 1 ms to 5 s (1 to 20 ms set in 1-ms increments, 20 to 200 ms set in 10-ms increments, 200 ms to 1 s set in 100-ms increments, and 1 to 5 s set in 1 s-increments) | | | | | |
| | Automatic power control (APC) | High-speed control method for emission current | | | | | |
| | Zero-reset | Negative values can be displayed. (Threshold value is shifted.) | | | | | |
| | Initial reset | Settings can be returned to defaults as required. | | | | | |
| | Mutual interference prevention | Possible for up to 10 Units ^{*7} | | | | | Possible for up to 9 Units (18 channels) ^{*8} |
| Counter | Switchable between up counter and down counter. Set count: 0 to 9,999,999 | --- | | | | | |

*1.This model allows you to use an E3X-ECT EtherCAT Communications Unit or E3X-CRT CompoNet Communications Unit.

*2.Input Specifications

| | Contact input (relay or switch) | Non-contact input (transistor) |
|-----|---|--|
| NPN | ON: Shorted to 0 V (sourcing current: 1 mA max.). OFF: Open or shorted to Vcc. | ON: 1.5 V max. (sourcing current: 1 mA max.) OFF: Vcc - 1.5 V to Vcc (leakage current: 0.1 mA max.) |
| PNP | ON: Shorted to Vcc (sinking current: 3 mA max.). OFF: Open or shorted to 0 V. | ON: Vcc - 1.5 V to Vcc (sinking current: 3 mA max.) OFF: 1.5 V max. (leakage current: 0.1 mA max.) |

*3.Communications are disabled if the detection mode is selected during super-high-speed mode, and the communications functions for mutual interference prevention and the Mobile Console will not function.

*4.PNP output is as follows: Operate: 53 μs, reset: 55 μs.

*5.When counter is enabled: 80 μs for operate and reset respectively.

*6.When differential output is selected for the output setting, the second channel output is 200 μs for operation and reset respectively.

*7.Mutual interference prevention can be used for only up to 6 Units if power tuning is enabled.

*8.Mutual interference prevention can be used for up to 5 Units (10 channels) if power tuning is enabled.

| Item | Type Model | Advanced models | | | | 2-channel models | |
|--------------------------------------|---------------|---|--|--|---|--|-------------------------------|
| | | External input models | Twin-output models | ATC function models | Analog output models | Standard models | Model for Communications Unit |
| | | E3X-DA□RM-S | E3X-DA□TW-S | E3X-DA□AT-S | E3X-DA□AN-S | E3X-MDA□ (□: 11/41/6/8) | E3X-MDA0 |
| Functions | I/O setting | External input setting (Select from teaching, power tuning, zero reset, light OFF, or counter reset.) | Output setting (Select from channel 2 output, area output, or self-diagnosis.) | Output setting (Select from channel 2 output, area output, self-diagnosis output, or ATC error output) | Analog output setting (offset voltage adjustable) | Output setting (Select from channel 2 output, AND, OR, leading edge sync, falling edge sync, or differential output) | |
| Display | | Operation indicator (orange), Power Tuning indicator (orange) | Operation indicator for channel 1 (orange), Operation indicator for channel 2 (orange) | | Operation indicator (orange), Power Tuning indicator (orange) | Operation indicator for channel 1 (orange), Operation indicator for channel 2 (orange) | |
| Digital display | | Select from incident level + threshold or other 7 patterns | Select from incident level + threshold or other 6 patterns | | | Select from incident level for channel 1 + incident level for channel 2 or other 7 patterns | |
| Display orientation | | Switching between normal/reversed display is possible. | | | | | |
| Ambient illumination (Receiver side) | | Incandescent lamp: 10,000 lux max. Sunlight: 20,000 lux max. | | | | | |
| Ambient temperature range | | Operating: Groups of 1 to 2 Amplifiers: -25°C to 55°C Groups of 3 to 10 Amplifiers: -25°C to 50°C Groups of 11 to 16 Amplifiers: -25°C to 45°C *9 Storage: -30°C to 70°C (with no icing or condensation) | | | | | |
| Ambient humidity range | | Operating and storage: 35% to 85% (with no condensation) | | | | | |
| Insulation resistance | | 20 MΩ min. (at 500 VDC) | | | | | |
| Dielectric strength | | 1,000 VAC at 50/60 Hz for 1 minute | | | | | |
| Vibration resistance (Destruction) | | 10 to 55 Hz with a 1.5-mm double amplitude for 2 hrs each in X, Y and Z directions | | | | 10 to 150 Hz with a 0.7-mm double amplitude for 80 min each in X, Y, and Z directions | |
| Shock resistance (Destruction) | | 500 m/s ² , for 3 times each in X, Y and Z directions | | | | 150 m/s ² for 3 times each in X, Y, and Z directions | |
| Degree of protection | | IEC 60529 IP50 (with Protective Cover attached) | | | | | |
| Connection method | | Pre-wired or amplifier unit connector | | | | Connector for Communications Unit | |
| Weight (packed state) | | Pre-wired model: Approx. 100 g, Amplifier unit connector model: Approx. 55 g | | | | Approx. 55 g | |
| Materials | Case | Polybutylene terephthalate (PBT) | | | | | |
| | Cover | Polycarbonate (PC) | | | | | |
| Accessories | | Instruction manual | | | | | |

*9. The following temperature ranges apply for operation when an E3X-ECT or E3X-CRT Communications Unit is used with the E3X-MDA0: Groups of 1 or 2 Amplifier Units: 0 to 55°C, Groups of 3 to 10 Amplifier Units: 0 to 50°C, Groups of 11 to 16 Amplifier Units: 0 to 45°C, Groups of 17 to 30 Amplifier Units (with the E3X-ECT): 0 to 40°C.

Amplifier Unit Connectors

| Item | Model | E3X-CN11/21/22 | E3X-CN12 |
|-----------------------|----------|---|--------------|
| Rated current | | 2.5 A | |
| Rated voltage | | 50 V | |
| Contact resistance | | 20 mΩ max. (20 mVDC max., 100 mA max.) (The figure is for connection to the Amplifier Unit and the adjacent Connector. It does not include the conductor resistance of the cable.) | |
| No. of insertions | | Destruction: 50 times (The figure for the number of insertions is for connection to the Amplifier Unit and the adjacent Connector.) | |
| Materials | Housing | Polybutylene terephthalate (PBT) | |
| | Contacts | Phosphor bronze/gold-plated nickel | |
| Weight (packed state) | | Approx. 55 g | Approx. 25 g |

Mobile Console

| Item | Model | E3X-MC11-SV2 |
|-----------------------|-------|---|
| Applicable Sensors | | E3X-DA-S E3X-MDA E3C-LDA E2C-EDA |
| Power supply voltage | | Charged with AC adapter |
| Connection method | | Connected via adapter |
| Weight (packed state) | | Approx. 580 g (Console only: 120 g) |

Refer to *Instruction Manual* provided with the Mobile Console for details.

Sensing Distance

● Single-function, Standard, Advanced, and 2-channel Amplifier Units

Threaded Models

(Unit: mm)

| Sensing method | Sensing direction | Size | Model | E3X-DA□-S | | | | E3X-MDA□ | | | |
|----------------|-------------------|--------------|--------------|----------------------|---------------|-----------------|-----------------------|----------------------|---------------|-----------------|-----------------------|
| | | | | High-resolution mode | Standard mode | High-speed mode | Super-high-speed mode | High-resolution mode | Standard mode | High-speed mode | Super-high-speed mode |
| Through-beam | Right-angle | M4 | E32-T11N 2M | 700 | 530 | 350 | 140 | 450 | 350 | 230 | 140 |
| | Straight | | E32-T11R 2M | | | | | | | | |
| Reflective | Right-angle | M3 | E32-C31N 2M | 40 | 25 | 16 | 7 | 24 | 16 | 10 | 7 |
| | | M6 | E32-C11N 2M | 280 | 170 | 110 | 50 | 160 | 110 | 70 | 50 |
| | Straight | M3 | E32-D21R 2M | 50 | 30 | 20 | 8 | 30 | 22 | 14 | 8 |
| | | | E32-C31 2M | 120 | 75 | 50 | 22 | 75 | 50 | 30 | 22 |
| | | E32-C31M 1M | | | | | | | | | |
| | | M4 | E32-D211R 2M | 50 | 30 | 20 | 8 | 30 | 22 | 14 | 8 |
| | M6 | E32-D11R 2M | 300 | 170 | 120 | 50 | 170 | 120 | 80 | 50 | |
| | | E32-CC200 2M | 500 | 300 | 200 | 90 | 300 | 210 | 140 | 90 | |

Cylindrical Models

| Sensing method | Size | Sensing direction | Model | E3X-DA□-S | | | | E3X-MDA□ | | | |
|----------------|-------------------|-------------------|---------------------|----------------------|---------------|-----------------|-----------------------|----------------------|---------------|-----------------|-----------------------|
| | | | | High-resolution mode | Standard mode | High-speed mode | Super-high-speed mode | High-resolution mode | Standard mode | High-speed mode | Super-high-speed mode |
| Through-beam | 1 dia. | Top-view | E32-T223R 2M | 160 | 130 | 75 | 30 | 110 | 85 | 55 | 30 |
| | 1.5 dia. | | E32-T22B 2M | 240 | 200 | 110 | 45 | 150 | 110 | 70 | 45 |
| Reflective | 3 dia. | Side-view | E32-T12R 2M | 700 | 530 | 350 | 140 | 450 | 350 | 230 | 140 |
| | | | E32-T14LR 2M | 270 | 210 | 130 | 50 | 170 | 130 | 85 | 50 |
| | 1.5 dia. | Top-view | E32-D22B 2M | 50 | 30 | 20 | 8 | 30 | 22 | 14 | 8 |
| | | | 1.5 dia. + 0.5 dia. | E32-D43M 1M | 10 | 6 | 4 | 2 | 6 | 4 | 2.5 |
| | 3 dia. | | E32-D22R 2M | 50 | 30 | 20 | 8 | 30 | 22 | 14 | 8 |
| | | | E32-D221B 2M | 110 | 70 | 45 | 20 | 70 | 50 | 30 | 20 |
| | 3 dia. + 0.8 dia. | E32-D32L 2M | 250 | 150 | 100 | 45 | 150 | 100 | 65 | 45 | |
| | | E32-D33 2M | 25 | 16 | 10 | 4 | 16 | 10 | 6 | 4 | |

Flat Models

| Sensing method | Sensing direction | Model | E3X-DA□-S | | | | E3X-MDA□ | | | |
|----------------|-------------------|--------------|----------------------|---------------|-----------------|-----------------------|----------------------|---------------|-----------------|-----------------------|
| | | | High-resolution mode | Standard mode | High-speed mode | Super-high-speed mode | High-resolution mode | Standard mode | High-speed mode | Super-high-speed mode |
| Through-beam | Top-view | E32-T15XR 2M | 700 | 530 | 350 | 140 | 450 | 350 | 230 | 140 |
| | Side-view | E32-T15YR 2M | 270 | 210 | 130 | 50 | 170 | 130 | 85 | 50 |
| | Flat-view | E32-T15ZR 2M | | | | | | | | |
| Reflective | Top-view | E32-D15XR 2M | 300 | 170 | 120 | 50 | 170 | 120 | 80 | 50 |
| | Side-view | E32-D15YR 2M | 70 | 40 | 26 | 12 | 40 | 29 | 19 | 12 |
| | Flat-view | E32-D15ZR 2M | | | | | | | | |

Sleeve Models

| Sensing method | Sensing direction | Model | E3X-DA□-S | | | | E3X-MDA□ | | | |
|----------------|-------------------|-----------------|----------------------|---------------|-----------------|-----------------------|----------------------|---------------|-----------------|-----------------------|
| | | | High-resolution mode | Standard mode | High-speed mode | Super-high-speed mode | High-resolution mode | Standard mode | High-speed mode | Super-high-speed mode |
| Through-beam | Side-view | E32-T24R 2M | 60 | 50 | 25 | 10 | 35 | 27 | 18 | 10 |
| | | E32-T24E 2M | 160 | 130 | 75 | 30 | 100 | 70 | 45 | 30 |
| | Top-view | E32-T33 1M | 53 | 44 | 25 | 10 | 35 | 28 | 18 | 10 |
| Reflective | Side-view | E32-TC200BR 2M | 700 | 530 | 350 | 140 | 450 | 350 | 230 | 140 |
| | | E32-D24R 2M | 26 | 15 | 10 | 4 | 15 | 10 | 6 | 4 |
| | Top-view | E32-D43M 1M | 10 | 6 | 4 | 2 | 6 | 4 | 2.5 | 2 |
| | | E32-D331 2M | 5 | 3 | 2 | 0.8 | 3 | 2 | 1.3 | 0.8 |
| | | E32-D33 2M | 25 | 16 | 10 | 4 | 16 | 10 | 6 | 4 |
| | | E32-DC200F4R 2M | 50 | 30 | 20 | 8 | 30 | 22 | 14 | 8 |
| E32-DC200BR 2M | 300 | 170 | 120 | 50 | 170 | 120 | 80 | 50 | | |

Note: The super-high-speed mode cannot be used with the E3X-MDA0.

Small-spot, Reflective

| Type | spot diameter | Center distance (mm) | Model | E3X-DA□-S | | | | E3X-MDA□ | | | |
|-----------------|-----------------|----------------------|---|--|---------------|-----------------|-----------------------|--|---------------|-----------------|-----------------------|
| | | | | High-resolution mode | Standard mode | High-speed mode | Super-high-speed mode | High-resolution mode | Standard mode | High-speed mode | Super-high-speed mode |
| Variable spot | 0.1 to 0.6 dia. | 6 to 5 | E32-C42 1M + E39-F3A | Spot diameter of 0.1 to 0.6 mm at 6 to 15 mm. | | | | Spot diameter of 0.1 to 0.6 mm at 6 to 15 mm. | | | |
| | 0.3 to 1.6 dia. | 10 to 30 | E32-C42 1M + E39-F17 | Spot diameter of 0.3 to 1.6 mm at 10 to 30 mm. | | | | Spot diameter of 0.3 to 1.6 mm at 10 to 30 mm. | | | |
| Parallel light | 4 dia. | 0 to 20 | E32-C31 2M + E39-F3C E32-C31N 2M + E39-F3C | Spot diameter of 4 mm max. at 0 to 20 mm. | | | | Spot diameter of 4 mm max. at 0 to 20 mm. | | | |
| Integrated lens | 0.1 dia. | 5 | E32-C42S 1M | Spot diameter of 0.1 mm at 5 mm. | | | | Spot diameter of 0.1 mm at 5 mm. | | | |
| Small-spot | 0.1 dia. | 7 | E32-C41 1M + E39-F3A-5 | Spot diameter of 0.1 mm at 7 mm. | | | | Spot diameter of 0.1 mm at 7 mm. | | | |
| | | | E32-C31 2M + E39-F3A-5 E32-C31N 2M + E39-F3A-5 | Spot diameter of 0.5 mm at 7 mm. | | | | Spot diameter of 0.5 mm at 7 mm. | | | |
| | 0.2 dia. | 17 | E32-C41 1M + E39-F3B | Spot diameter of 0.2 mm at 17 mm. | | | | Spot diameter of 0.2 mm at 17 mm. | | | |
| | | | E32-C31 2M + E39-F3B E32-C31N 2M + E39-F3B | Spot diameter of 0.5 mm at 17 mm. | | | | Spot diameter of 0.5 mm at 17 mm. | | | |
| | 0.5 dia. | 50 | E32-CC200 2M + E39-F18 | Spot diameter of 3 mm at 50 mm. | | | | Spot diameter of 3 mm at 50 mm. | | | |
| | | | E32-C11N 2M + E39-F18 | Spot diameter of 3 mm at 50 mm. | | | | Spot diameter of 3 mm at 50 mm. | | | |

High-power Beam

| Type | Sensing direction | Aperture angle | Model | E3X-DA□-S | | | | E3X-MDA□ | | | |
|---------------------------------|-------------------|----------------|-------------------------|----------------------|---------------|-----------------|-----------------------|----------------------|---------------|-----------------|-----------------------|
| | | | | High-resolution mode | Standard mode | High-speed mode | Super-high-speed mode | High-resolution mode | Standard mode | High-speed mode | Super-high-speed mode |
| Through-beam Integrated lens | Top-view | 10 ° | E32-T17L 10M | 20,000 *1 | 20,000 *1 | 10,000 | 4,000 | 13,000 | 10,000 | 6,500 | 4,000 |
| | Side-view | 30 ° | E32-T14 2M | 4,000 *2 | 3,400 | 2,250 | 900 | 2,900 | 2,200 | 1,450 | 900 |
| Through-beam models with lenses | Right-angle | 12 ° | E32-T11N 2M + E39-F1 | 4,000 *2 | 3,700 | 2,400 | 970 | 3,100 | 2,400 | 1,600 | 970 |
| | | 6 ° | E32-T11N 2M + E39-F16 | 4,000 *2 | 4,000 *2 | 4,000 *2 | 1,700 | 4,000 *2 | 4,000 *2 | 2,900 | 1,700 |
| | Top-view | 12 ° | E32-T11R 2M + E39-F1 | 4,000 *2 | 3,700 | 2,400 | 970 | 3,100 | 2,400 | 1,600 | 970 |
| | | 6 ° | E32-T11R 2M + E39-F16 | 4,000 *2 | 4,000 *2 | 4,000 *2 | 1,700 | 4,000 *2 | 4,000 *2 | 2,900 | 1,700 |
| | Side-view | 60 ° | E32-T11R 2M + E39-F2 | 520 | 400 | 250 | 100 | 330 | 260 | 170 | 100 |
| | | 12 ° | E32-T11 2M + E39-F1 | 4,000 *2 | 3,600 | 2,300 | 930 | 3,000 | 2,300 | 1,500 | 930 |
| | Top-view | 6 ° | E32-T11 2M + E39-F16 | 4,000 *2 | 4,000 *2 | 4,000 *2 | 2,200 | 4,000 *2 | 4,000 *2 | 3,700 | 2,200 |
| | | 60 ° | E32-T11 2M + E39-F2 | 820 | 660 | 430 | 160 | 530 | 430 | 280 | 160 |
| | Top-view | 12 ° | E32-T51R 2M + E39-F1 | 3,900 | 2,900 | 1,900 | 780 | 2,500 | 1,900 | 1,300 | 780 |
| | | 6 ° | E32-T51R 2M + E39-F16 | 4,000 *2 | 4,000 *2 | 3,500 | 1,400 | 4,000 *2 | 3,500 | 2,300 | 1,400 |
| | Side-view | 60 ° | E32-T51R 2M + E39-F2 | 500 | 380 | 250 | 100 | 320 | 250 | 160 | 100 |
| | | 12 ° | E32-T81R-S 2M + E39-F1 | 4,000 *2 | 3,200 | 2,100 | 840 | 2,700 | 2,100 | 1,380 | 840 |
| | Top-view | 6 ° | E32-T81R-S 2M + E39-F16 | 4,000 *2 | 4,000 *2 | 3,700 | 1,500 | 4,000 *2 | 3,700 | 2,500 | 1,500 |
| | | 60 ° | E32-T81R-S 2M + E39-F2 | 540 | 410 | 270 | 100 | 350 | 270 | 170 | 100 |
| | Top-view | 12 ° | E32-T61-S 2M + E39-F1 | 4,000 | 3,400 | 2,200 | 900 | 3,000 | 2,200 | 1,450 | 900 |
| | | 6 ° | E32-T61-S 2M + E39-F16 | 4,000 *2 | 4,000 *2 | 3,700 | 1,500 | 4,000 *2 | 3,700 | 2,500 | 1,500 |
| | Side-view | 60 ° | E32-T61-S 2M + E39-F2 | 600 | 450 | 300 | 120 | 390 | 300 | 200 | 120 |
| | | 12 ° | E32-T51 2M + E39-F1-33 | 4,000 *2 | 4,000 *2 | 3,500 | 1,400 | 4,000 *2 | 3,500 | 2,300 | 1,400 |
| | Top-view | 6 ° | E32-T51 2M + E39-F16 | 4,000 *2 | 4,000 *2 | 4,000 *2 | 2,500 | 4,000 *2 | 4,000 *2 | 4,000 *2 | 2,500 |
| | | 4 ° | E32-D16 2M | 40 to 1,000 | 40 to 700 | 40 to 450 | 40 to 240 | 40 to 600 | 40 to 490 | 40 to 300 | 40 to 240 |

*1. The fiber length is 10 m on each side, so the sensing distance is given as 20,000 mm.

*2. The fiber length is 2 m on each side, so the sensing distance is given as 4,000 mm.

Narrow View

| Sensing method | Sensing direction | Aperture angle | Model | E3X-DA□-S | | | | E3X-MDA□ | | | |
|----------------|-------------------|----------------|--------------|----------------------|---------------|-----------------|-----------------------|----------------------|---------------|-----------------|-----------------------|
| | | | | High-resolution mode | Standard mode | High-speed mode | Super-high-speed mode | High-resolution mode | Standard mode | High-speed mode | Super-high-speed mode |
| Through-beam | Side-view | 1.5 ° | E32-A03 2M | 1,150 | 890 | 600 | 250 | 750 | 580 | 380 | 250 |
| | | | E32-A03-1 2M | | | | | | | | |
| | | 3.4 ° | E32-A04 2M | 460 | 340 | 225 | 100 | 300 | 220 | 145 | 100 |
| | | | E32-T24SR 2M | 1,480 | 1,100 | 730 | 290 | 920 | 730 | 480 | 290 |
| | | 4 ° | E32-T24S 2M | 1,750 | 1,300 | 870 | 350 | 1,100 | 870 | 580 | 350 |
| | | | E32-T22S 2M | 2,500 | 1,900 | 1,250 | 500 | 1,600 | 1,250 | 830 | 500 |

Detection without Background Interference

| Sensing method | Sensing direction | Model | E3X-DA□-S | | | | E3X-MDA□ | | | |
|--------------------|-------------------|--------------|-----------------------|---------------|-----------------|-----------------------|-----------------------|---------------|-----------------|-----------------------|
| | | | High-resolution mode | Standard mode | High-speed mode | Super-high-speed mode | High-resolution mode | Standard mode | High-speed mode | Super-high-speed mode |
| Limited-reflective | Flat-view | E32-L16-N 2M | 0 to 15 | | | | 0 to 12 | | | |
| | | E32-L24S 2M | 0 to 4 | | | | 0 to 4 | | | |
| | Side-view | E32-L25L 2M | 5.4 to 9 (center 7.2) | | | | 5.4 to 9 (center 7.2) | | | |

Note: The super-high-speed mode cannot be used with the E3X-MDA0.

Transparent Object Detection (Retro-reflective)

| Sensing method | Feature | Size | Model | E3X-DA□-S | | | | E3X-MDA□ | | | |
|------------------|-----------------|------|---------------------------------|----------------------|---------------|-----------------|-----------------------|----------------------|---------------|-----------------|-----------------------|
| | | | | High-resolution mode | Standard mode | High-speed mode | Super-high-speed mode | High-resolution mode | Standard mode | High-speed mode | Super-high-speed mode |
| Retro-reflective | Film detection | M3 | E32-C31 2M + E39-F3R + E39-RP37 | 250 | 150 | 100 | 45 | 150 | 100 | 65 | 45 |
| | Square | – | E32-R16 2M | 10 to 250 | | | | 10 to 250 | | | |
| | Threaded models | M6 | E32-R21 2M | 150 to 1500 | | | | 150 to 1500 | | | |

Transparent Object Detection (Limited-reflective)

| Sensing method | Feature | Sensing direction | Model | E3X-DA□-S | | | | E3X-MDA□ | | | |
|--------------------|----------------------------------|-------------------|--------------|-----------------------|---------------|-----------------|-----------------------|-----------------------|---------------|-----------------|-----------------------|
| | | | | High-resolution mode | Standard mode | High-speed mode | Super-high-speed mode | High-resolution mode | Standard mode | High-speed mode | Super-high-speed mode |
| Limited-reflective | Small size | Flat-view | E32-L24S 2M | 0 to 4 | | | | 0 to 4 | | | |
| | Standard | | E32-L16-N 2M | 0 to 15 | | 0 to 12 | 0 to 15 | | 0 to 12 | | |
| | Glass substrate alignment, 70 °C | | E32-A08 2M | 10 to 20 | | – | 10 to 20 | | – | | |
| | Standard/long-distance | E32-A12 2M | 12 to 30 | | – | 12 to 30 | | – | | | |
| | Side view form | Side-view | E32-L25L 2M | 5.4 to 9 (center 7.2) | | | | 5.4 to 9 (center 7.2) | | | |
| | Glass substrate mapping, 70 °C | Top-view | E32-A09 2M | 15 to 38 | | – | 15 to 38 | | – | | |

Chemical-resistant, Oil-resistant

| Sensing method | Type | Sensing direction | Model | E3X-DA□-S | | | | E3X-MDA□ | | | |
|----------------|----------------------------------|-------------------|--------------|----------------------|---------------|-----------------|-----------------------|----------------------|---------------|-----------------|-----------------------|
| | | | | High-resolution mode | Standard mode | High-speed mode | Super-high-speed mode | High-resolution mode | Standard mode | High-speed mode | Super-high-speed mode |
| Through-beam | Oil-resistant | Right-angle | E32-T11NF 2M | 4,000 * | 4,000 * | 2,800 | 1,100 | 3,600 | 2,800 | 1,800 | 1,100 |
| | Chemical/oil-resistant | Top-view | E32-T12F 2M | 4,000 * | 3,000 | 2,000 | 800 | 2,600 | 2,000 | 1,300 | 800 |
| | | Side-view | E32-T11F 2M | 2,500 | 2,000 | 1,300 | 520 | 1,600 | 1,300 | 850 | 520 |
| | | | | E32-T14F 2M | 500 | 400 | 250 | 100 | 320 | 250 | 160 |
| Reflective | Chemical/oil-resistant at 150 °C | Top-view | E32-T51F 2M | 1,800 | 1,400 | 900 | 350 | 1,190 | 920 | 600 | 350 |
| | Chemical/oil-resistant | Top-view | E32-D12F 2M | 160 | 95 | 65 | 30 | 95 | 70 | 45 | 30 |
| | Chemical-resistant cable | | E32-D11U 2M | 300 | 170 | 120 | 50 | 170 | 125 | 80 | 50 |

* The fiber length is 2 m on each side, so the sensing distance is given as 4,000 mm.

Bending-resistant

| Sensing method | Size | Model | E3X-DA□-S | | | | E3X-MDA□ | | | |
|----------------|----------|--------------|----------------------|---------------|-----------------|-----------------------|----------------------|---------------|-----------------|-----------------------|
| | | | High-resolution mode | Standard mode | High-speed mode | Super-high-speed mode | High-resolution mode | Standard mode | High-speed mode | Super-high-speed mode |
| Through-beam | 1.5 dia. | E32-T22B 2M | 240 | 200 | 110 | 45 | 150 | 110 | 70 | 45 |
| | M3 | E32-T21 2M | | | | | | | | |
| | M4 | E32-T11 2M | | | | | | | | |
| | Square | E32-T25XB 2M | | | | | | | | |
| Reflective | 1.5 dia. | E32-D22B 2M | 50 | 30 | 20 | 8 | 30 | 22 | 14 | 8 |
| | M3 | E32-D21 2M | | | | | | | | |
| | 3 dia. | E32-D221B 2M | | | | | | | | |
| | M4 | E32-D21B 2M | | | | | | | | |
| | M6 | E32-D11 2M | | | | | | | | |
| | Square | E32-D25XB 2M | | | | | | | | |

Note: The super-high-speed mode cannot be used with the E3X-MDA0.

Heat-resistant

| Sensing method | Heat-resistant temperature | Model | E3X-DA□-S | | | | E3X-MDA□ | | | |
|----------------|----------------------------|---------------|----------------------|---------------|-----------------|-----------------------|----------------------|---------------|-----------------|-----------------------|
| | | | High-resolution mode | Standard mode | High-speed mode | Super-high-speed mode | High-resolution mode | Standard mode | High-speed mode | Super-high-speed mode |
| Through-beam | 100 °C | E32-T51R 2M | 560 | 425 | 280 | 110 | 360 | 280 | 180 | 110 |
| | 150 °C | E32-T51 2M | 1,000 | 760 | 500 | 200 | 650 | 500 | 330 | 200 |
| | 200 °C | E32-T81R-S 2M | 360 | 280 | 180 | 70 | 230 | 180 | 120 | 70 |
| | 350 °C | E32-T61-S 2M | 600 | 450 | 300 | 120 | 390 | 300 | 200 | 120 |
| Reflective | 100 °C | E32-D51R 2M | 240 | 135 | 95 | 40 | 130 | 95 | 60 | 40 |
| | 150 °C | E32-D51 2M | 400 | 230 | 160 | 72 | 230 | 165 | 110 | 72 |
| | 200 °C | E32-D81R-S 2M | 150 | 90 | 60 | 27 | 90 | 63 | 40 | 27 |
| | 300 °C | E32-A08H2 2M | 10 to 20 | | - | | 10 to 20 | | - | |
| | | E32-A09H2 2M | 20 to 30 | | - | | 20 to 30 | | - | |
| | 350 °C | E32-D611-S 2M | 150 | 90 | 60 | 27 | 90 | 63 | 40 | 27 |
| | | E32-D61-S 2M | | | | | | | | |
| | 400 °C | E32-D73-S 2M | 100 | 60 | 40 | 18 | 60 | 40 | 25 | 18 |

Area Beam

| Sensing method | Type | Sensing width | Model | E3X-DA□-S | | | | E3X-MDA□ | | | |
|----------------|-------|---------------|--------------|----------------------|---------------|-----------------|-----------------------|----------------------|---------------|-----------------|-----------------------|
| | | | | High-resolution mode | Standard mode | High-speed mode | Super-high-speed mode | High-resolution mode | Standard mode | High-speed mode | Super-high-speed mode |
| Through-beam | Area | 11 mm | E32-T16PR 2M | 1,100 | 840 | 560 | 220 | 730 | 560 | 370 | 220 |
| | | | E32-T16JR 2M | 980 | 750 | 480 | 190 | 600 | 480 | 320 | 190 |
| | | 30 mm | E32-T16WR 2M | 1,700 | 1,300 | 850 | 340 | 1,100 | 860 | 570 | 340 |
| Reflective | Array | 11 mm | E32-D36P1 2M | 250 | 150 | 100 | 45 | 150 | 100 | 65 | 45 |

Liquid-level Detection

| Sensing method | Tube diameter | Feature | Model | E3X-DA□-S | | | | E3X-MDA□ | | | |
|--|------------------|------------------------------------|--------------|--|---------------|-----------------|-----------------------|--|---------------|-----------------|-----------------------|
| | | | | High-resolution mode | Standard mode | High-speed mode | Super-high-speed mode | High-resolution mode | Standard mode | High-speed mode | Super-high-speed mode |
| Tube-mounting | 3.2/6.4/9.5 dia. | Stable residual quantity detection | E32-A01 5M | Applicable tube: Transparent tube with a diameter of 3.2, 6.4, or 9.5 mm, Recommended wall thickness: 1 mm | | | | Applicable tube: Transparent tube with a diameter of 3.2, 6.4, or 9.5 mm, Recommended wall thickness: 1 mm | | | |
| | 8 to 10 dia. | Mounting at multi levels | E32-L25T 2M | Applicable tube: Transparent tube with a diameter of 8 to 10 mm, Recommended wall thickness: 1 mm | | | | Applicable tube: Transparent tube with a diameter of 8 to 10 mm, Recommended wall thickness: 1 mm | | | |
| | No restrictions | Large tubes | E32-D36T 2M | Applicable tube: Transparent tube (no restriction on diameter) | | | | Applicable tube: Transparent tube (no restriction on diameter) | | | |
| Liquid contact (heat-resistant up to 200 °C) | - | - | E32-D82F1 4M | Liquid-contact Type | | | | Liquid-contact Type | | | |

Vacuum-resistant

| Sensing method | Heat-resistant temperature | Model | E3X-DA□-S | | | | E3X-MDA□ | | | |
|----------------|----------------------------|-----------------------|----------------------|---------------|-----------------|-----------------------|----------------------|---------------|-----------------|-----------------------|
| | | | High-resolution mode | Standard mode | High-speed mode | Super-high-speed mode | High-resolution mode | Standard mode | High-speed mode | Super-high-speed mode |
| Through-beam | 120 °C | E32-T51V 1M | 260 | 200 | 130 | 50 | 170 | 130 | 85 | 50 |
| | | E32-T51V 1M + E39-F1V | 1,350 | 1,000 | 680 | 260 | 850 | 650 | 430 | 260 |
| | 200 °C | E32-T84SV 1M | 630 | 480 | 320 | 130 | 410 | 310 | 200 | 130 |

FPD, Semiconductors, and Solar Cells

| Sensing method | Application | Operating temperature | Model | E3X-DA□-S | | | | E3X-MDA□ | | | |
|--------------------|---------------------------|-----------------------|--------------|----------------------|---------------|-----------------|-----------------------|----------------------|---------------|-----------------|-----------------------|
| | | | | High-resolution mode | Standard mode | High-speed mode | Super-high-speed mode | High-resolution mode | Standard mode | High-speed mode | Super-high-speed mode |
| Limited-reflective | Glass presence detection | 70 °C | E32-L16-N 2M | 0 to 15 | | 0 to 12 | | 0 to 15 | | 0 to 12 | |
| | | | E32-A08 2M | 10 to 20 | | - | | 10 to 20 | | - | |
| | Glass substrate alignment | 300 °C | E32-A08H2 2M | 12 to 30 | | - | | 12 to 30 | | - | |
| | | | E32-A12 2M | 15 to 38 | | - | | 15 to 38 | | - | |
| | Glass substrate mapping | 300 °C | E32-A09 2M | 20 to 30 | | - | | 20 to 30 | | - | |
| E32-A09H2 2M | | | 20 to 30 | | - | | 20 to 30 | | - | | |
| Through-beam | Wafer mapping | 70 °C | E32-A03 2M | 1,150 | 890 | 600 | 250 | 750 | 580 | 380 | 250 |
| | | | E32-A03-1 2M | | | | | | | | |
| | | | E32-A04 2M | 460 | 340 | 225 | 100 | 300 | 220 | 145 | 100 |
| | | | E32-T24SR 2M | 1,480 | 1,100 | 730 | 290 | 920 | 730 | 480 | 290 |
| | | | E32-T24S 2M | 1,750 | 1,300 | 870 | 350 | 1,100 | 870 | 580 | 350 |

Note: The super-high-speed mode cannot be used with the E3X-MDA0.

● Mark-detecting Amplifier Units (Different Colors of Light Sources)

Threaded Models

| Sensing method | Sensing direction | Size | Model | E3X-DAG□-S/DAB□-S | | | | E3X-DAH□-S | | | |
|----------------|-------------------|------|--------------|----------------------|---------------|-----------------|-----------------------|----------------------|---------------|-----------------|-----------------------|
| | | | | High-resolution mode | Standard mode | High-speed mode | Super-high-speed mode | High-resolution mode | Standard mode | High-speed mode | Super-high-speed mode |
| Through-beam | Right-angle | M4 | E32-T11N 2M | 65 | 50 | 35 | 30 | 280 | 190 | 130 | 55 |
| | Straight | | E32-T11R 2M | | | | | | | | |
| Reflective | Straight | M3 | E32-C31 2M | 7.5 | 6 | 4 | 3.5 | 50 | 37 | 25 | 8.5 |
| | | M6 | E32-D11R 2M | 17 | 14 | 10 | 8 | 120 | 90 | 60 | 21 |
| | | | E32-CC200 2M | 32 | 25 | 16 | 16 | 200 | 150 | 100 | 35 |

Cylindrical Models

| Sensing method | Size | Sensing direction | Model | E3X-DAG□-S/DAB□-S | | | | E3X-DAH□-S | | | |
|----------------|--------|-------------------|--------------|----------------------|---------------|-----------------|-----------------------|----------------------|---------------|-----------------|-----------------------|
| | | | | High-resolution mode | Standard mode | High-speed mode | Super-high-speed mode | High-resolution mode | Standard mode | High-speed mode | Super-high-speed mode |
| Through-beam | 3 dia. | Top-view | E32-T12R 2M | 65 | 50 | 35 | 30 | 280 | 190 | 130 | 55 |
| | | Side-view | E32-T14LR 2M | 25 | 20 | 22 | 12 | 100 | 75 | 80 | 21 |
| Reflective | 3 dia. | Top-view | E32-D32L 2M | 15 | 12 | 8 | 7.5 | 100 | 75 | 50 | 17 |

Flat Models

| Sensing method | Sensing direction | Model | E3X-DAG□-S/DAB□-S | | | | E3X-DAH□-S | | | |
|----------------|-------------------|--------------|----------------------|---------------|-----------------|-----------------------|----------------------|---------------|-----------------|-----------------------|
| | | | High-resolution mode | Standard mode | High-speed mode | Super-high-speed mode | High-resolution mode | Standard mode | High-speed mode | Super-high-speed mode |
| Through-beam | Top-view | E32-T15XR 2M | 25 | 20 | 22 | 12 | 100 | 75 | 80 | 21 |
| | Side-view | E32-T15YR 2M | | | | | | | | |
| | Flat-view | E32-T15ZR 2M | | | | | | | | |
| Reflective | Top-view | E32-D15XR 2M | 17 | 14 | 10 | 8 | 120 | 90 | 60 | 21 |
| | Side-view | E32-D15YR 2M | 4.2 | 3.3 | 2.2 | 2.1 | 28 | 20 | 13 | 5 |
| | Flat-view | E32-D15ZR 2M | | | | | | | | |

Sleeve Models

| Sensing method | Sensing direction | Model | E3X-DAG□-S/DAB□-S | | | | E3X-DAH□-S | | | |
|----------------|-------------------|----------------|----------------------|---------------|-----------------|-----------------------|----------------------|---------------|-----------------|-----------------------|
| | | | High-resolution mode | Standard mode | High-speed mode | Super-high-speed mode | High-resolution mode | Standard mode | High-speed mode | Super-high-speed mode |
| Through-beam | Top-view | E32-TC200BR 2M | 65 | 50 | 35 | 30 | 280 | 190 | 130 | 55 |
| Reflective | Top-view | E32-DC200BR 2M | 17 | 14 | 10 | 8 | 120 | 90 | 60 | 21 |

High-power Beam

| Type | Sensing direction | Aperture angle | Model | E3X-DAG□-S/DAB□-S | | | | E3X-DAH□-S | | | |
|------------------------------|-------------------|----------------|------------|----------------------|---------------|-----------------|-----------------------|----------------------|---------------|-----------------|-----------------------|
| | | | | High-resolution mode | Standard mode | High-speed mode | Super-high-speed mode | High-resolution mode | Standard mode | High-speed mode | Super-high-speed mode |
| Through-beam Integrated lens | Side-view | 30 ° | E32-T14 2M | 320 | 260 | 220 | 160 | 1800 | 1200 | 820 | 360 |

Output Circuit Diagrams

NPN Output

| Model | Operation mode | Timing charts | Operation selector | Output circuit |
|---|----------------|---------------|--------------------|----------------|
| E3X-DA11-S E3X-DA6-S E3X-DAG11-S E3X-DAG6-S E3X-DAB11-S E3X-DAB6-S E3X-DAH11-S E3X-DAH6-S E3X-DA11SE-S E3X-DA6SE-S | Light-ON | | LIGHT ON (L-ON) | |
| | Dark-ON | | DARK ON (D-ON) | |
| E3X-DA11TW-S E3X-DA6TW-S E3X-MDA11 E3X-MDA6 E3X-DA11AT-S E3X-DA6AT-S | Light-ON | | LIGHT ON (L-ON) | |
| | Dark-ON | | DARK ON (D-ON) | |
| E3X-DA11RM-S E3X-DA6RM-S | Light-ON | | LIGHT ON (L-ON) | |
| | Dark-ON | | DARK ON (D-ON) | |
| E3X-DA11AN-S | Light-ON | | LIGHT ON (L-ON) | |
| | Dark-ON | | DARK ON (D-ON) | |

Note: 1. The ON/OFF regions when areas settings are used with the E3X-DA□TW-S are as follows:
 LIGHT ON: ON when the incident level is between the thresholds for channels 1 and 2.
 DARK ON: OFF when the incident level is between the thresholds for channels 1 and 2.
 2. Timing Charts for Timer Function Settings (T: Set Time)

| ON delay | OFF delay | One-shot |
|----------|-----------|----------|
| | | |

3. Control Output (AND, OR, Sync) and Timing Chart for Timer Settings (T: Set Time)

| | | | |
|---------------|--------------|----------------|--------------------|
| CH1 ON | CH1 ON | ON delay ON | ON delay ON |
| CH1 OFF | CH1 OFF | ON delay OFF | ON delay OFF |
| CH2 ON | CH2 ON | OUT (AND) ON | OUT (AND) ON |
| CH2 OFF | CH2 OFF | OUT (AND) OFF | OUT (AND) OFF |
| OUT (AND) ON | OUT (OR) ON | OUT (sync) ON | One-shot (AND) ON |
| OUT (AND) OFF | OUT (OR) OFF | OUT (sync) OFF | One-shot (AND) OFF |

PNP Output

| Model | Operation mode | Timing chart | Operation selector | Output circuit |
|---|----------------|--------------|--------------------|----------------|
| E3X-DA41-S E3X-DA8-S E3X-DAG41-S E3X-DAG8-S E3X-DAB41-S E3X-DAB8-S E3X-DAH41-S E3X-DAH8-S E3X-DA41SE-S E3X-DA8SE-S | Light-ON | | LIGHT ON (L-ON) | |
| | Dark-ON | | DARK ON (D-ON) | |
| E3X-DA41TW-S E3X-DA8TW-S E3X-MDA41 E3X-DA41AT-S E3X-DA8AT-S | Light-ON | | LIGHT ON (L-ON) | |
| | Dark-ON | | DARK ON (D-ON) | |
| E3X-DA41RM-S E3X-DA8RM-S | Light-ON | | LIGHT ON (L-ON) | |
| | Dark-ON | | DARK ON (D-ON) | |
| E3X-DA41AN-S | Light-ON | | LIGHT ON (L-ON) | |
| | Dark-ON | | DARK ON (D-ON) | |

Note: The ON/OFF regions when areas settings are used with the E3X-DA□TW-S are as follows:
 LIGHT ON: ON when the incident level is between the thresholds for channels 1 and 2.
 DARK ON: OFF when the incident level is between the thresholds for channels 1 and 2.

Nomenclature

Amplifier Units

E3X-DA□-S

E3X-DA□RM-S

E3X-DA□AN-S

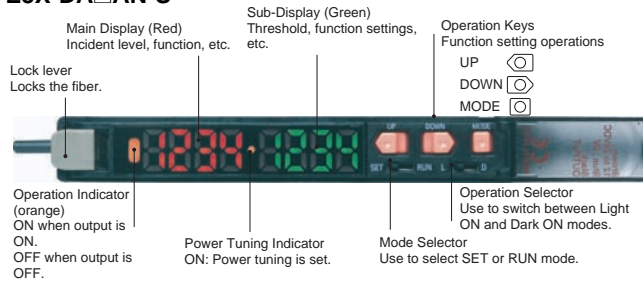

E3X-DA□TW-S

E3X-DA□AT-S

E3X-MDA□

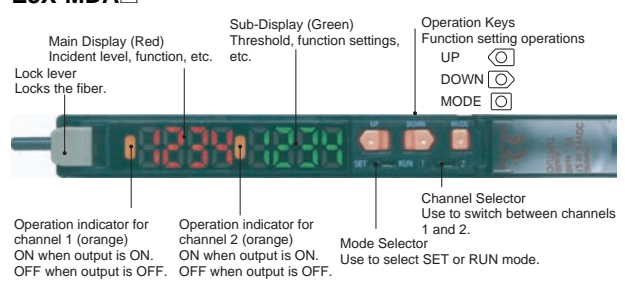

Safety Precautions

Refer to *Warranty and Limitations of Liability*.

WARNING

This product is not designed or rated for ensuring safety of persons either directly or indirectly. Do not use it for such purposes.



Precautions for Correct Use

Do not use the product in atmospheres or environments that exceed product ratings.

Amplifier Unit

● Designing

Operation after Turning Power ON

The Sensor is ready to detect within 200 ms after the power supply is turned ON. If the Sensor and load are connected to separate power supplies, be sure to turn ON the Sensor first.

● Mounting

Connecting and Disconnecting Wire-saving Connectors

Mounting Connectors

1. Insert the Master or Slave Connector into the Amplifier Unit until it clicks into place.

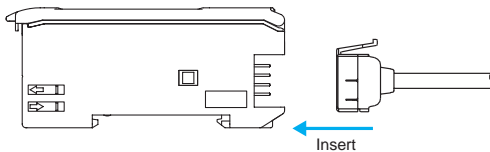

2. Attach the protector seals (provided as accessories) to the sides of master and slave connectors that are not connected.

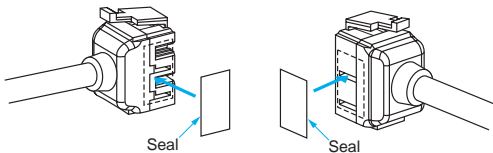

Note: Attach the seals to the sides with grooves.

Removing Connectors

1. Slide the slave Amplifier Unit(s) for which the Connector is to be removed away from the rest of the group.
2. After the Amplifier Unit(s) has been separated, press down on the lever on the Connector and remove it. (Do not attempt to remove Connectors without separating them from other Amplifier Units first.)

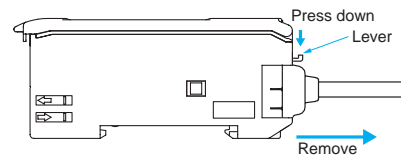

Adding and Removing Amplifier Units

Adding Amplifier Units

1. Mount the Amplifier Units one at a time onto the DIN track.

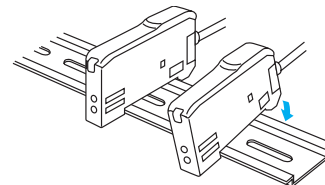

2. Slide the Amplifier Units together, line up the clips, and press the Amplifier Units together until they click into place.

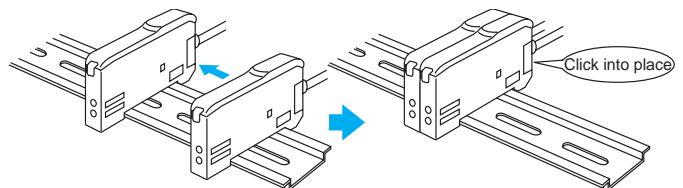

Removing Amplifier Units

Slide Amplifier Units away from each other, and remove from the DIN track one at a time. (Do not attempt to remove Amplifier Units from the DIN track without separating them first.)

Note: 1. The specifications for ambient temperature will vary according to the number of Amplifier Units used together. For details, refer to *Ratings and Specifications*.
2. Always turn OFF the power supply before joining or separating Amplifier Units.

Mounting the End Plate (PFP-M)

An End Plate should be used if there is a possibility of the Amplifier Unit moving, e.g., due to vibration. If a Mobile Console is going to be mounted, connect the End Plate in the direction shown in the following diagram.

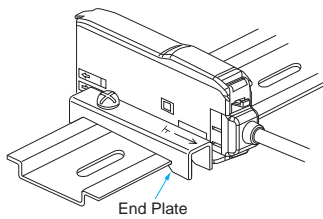

Mounting the Mobile Console Head

Leave a gap of at least 20 mm between the nearest Amplifier Unit and the Mobile Console head.

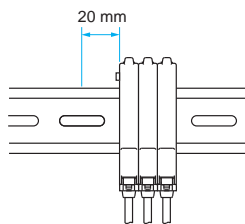

Fiber Connection

The E3X Amplifier Unit has a lock button for easy connection of the Fiber Unit. Connect or disconnect the fibers using the following procedures:

1. Connection

Open the protective cover, insert the fibers according to the fiber insertion marks on the side of the Amplifier Unit, and lower the lock lever.

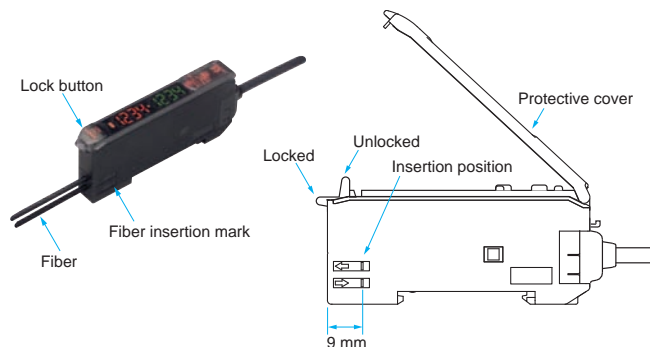

Note: If one of the fibers from the Fiber Unit is labeled as the Emitter fiber, such as with a Coaxial Sensor, insert that fiber into the Emitter section. Refer to *Dimensions for the Fiber Unit* to see if there is an Emitter fiber label.

Fibers with E39-F9 Attachment

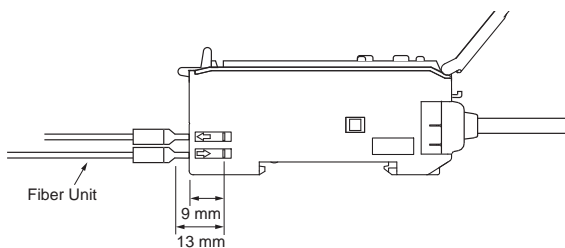

Fibers That Cannot Be Free-Cut (with Sleeves)

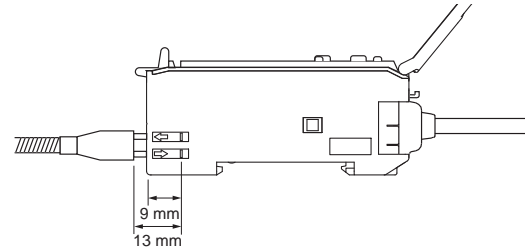

2. Disconnecting Fibers

Remove the protective cover and raise the lock lever to pull out the fibers.

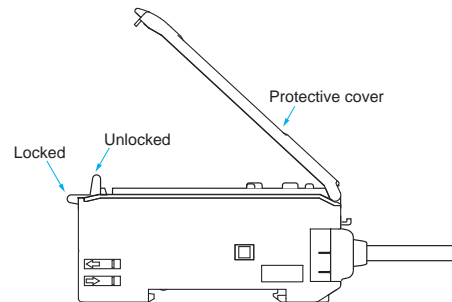

Note: 1. To maintain the fiber properties, confirm that the lock is released before removing the fibers.
2. Be sure to lock or unlock the lock button within an ambient temperature range between -10°C and 40°C .

● Adjusting

Mutual Interference Protection Function

There may be some instability in the digital display values due to light from other sensors. If this occurs, decrease the sensitivity (i.e., decrease the power or increase the threshold) to perform stable detection.

EEPROM Writing Error

If the data is not written to the EEPROM correctly due to a power failure or static-electric noise, initialize the settings with the keys on the Amplifier Unit. ERR/EEP will flash on the display when a writing error has occurred.

Optical Communications

Several Amplifier Units can be slid together and used in groups. Do not, however, slide the Amplifier Units or attempt to remove any of the Amplifier Units during operation.

● Others

Protective Cover

Always keep the protective cover in place when using the Amplifier Unit.

Mobile Console

Use the E3X-MC11-SV2 Mobile Console for the E3X-DA-S-series Amplifier Units.

Dimensions

Amplifier Units

Amplifier Units with Cables

- E3X-DA11-S
- E3X-DA41-S
- E3X-DAG11-S
- E3X-DAG41-S
- E3X-DAB11-S
- E3X-DAB41-S
- E3X-DAH11-S
- E3X-DAH41-S
- E3X-DA11RM-S
- E3X-DA41RM-S
- E3X-DA11TW-S
- E3X-DA41TW-S
- E3X-DA11SE-S
- E3X-DA41SE-S
- E3X-DA11AT-S
- E3X-DA41AT-S
- E3X-DA11AN-S
- E3X-DA41AN-S
- E3X-MDA11
- E3X-MDA41



Area of digital indication

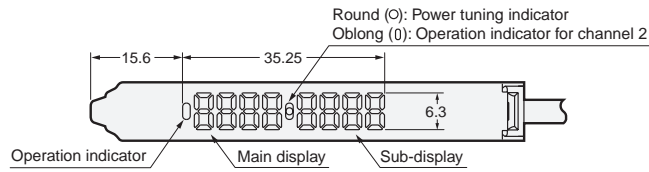

DIN track mounting

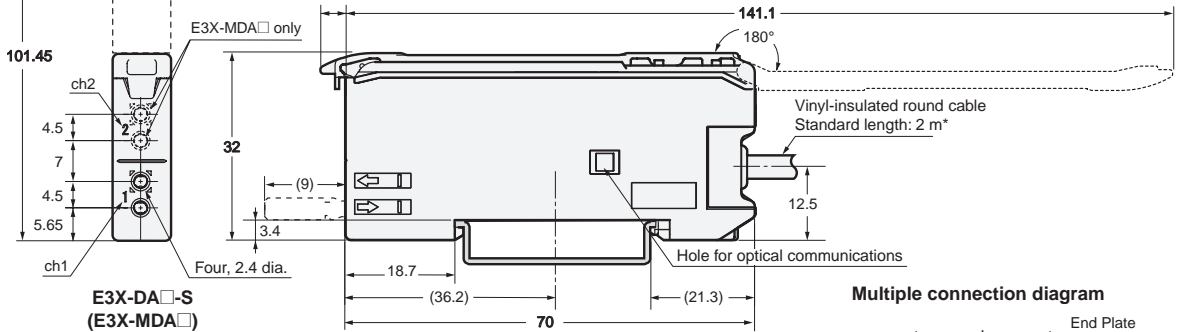

Multiple connection diagram

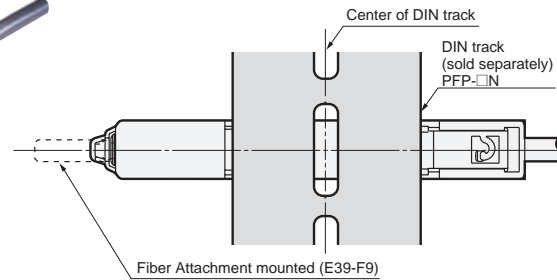
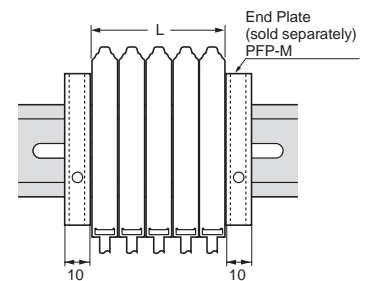

| The number of expansion | L (mm) |
|-------------------------|--------|
| 1 | 10 |
| 2 | 20 |
| 3 | 30 |
| 4 | 40 |
| 5 | 50 |
| 6 | 60 |
| 7 | 70 |
| 8 | 80 |
| 9 | 90 |
| 10 | 100 |

* Cable Specifications

| | |
|---|---|
| E3X-DA11-S -DA41-S -DAG11-S -DAG41-S -DAB11-S -DAB41-S -DAH11-S -DAH41-S | 4-dia., 3-conductor (Conductor cross section: 0.2 mm ² , insulator diameter: 1.1 mm) |
| E3X-DA11TW-S -DA41TW-S -DA11RM-S -DA41RM-S | 4-dia., 4-conductor (Conductor cross section: 0.2 mm ² , insulator diameter, 1.1 mm) |
| E3X-MDA11 -MDA41 | 4-dia., 2-conductor (Conductor cross section: 0.2 mm ² , insulator diameter: 1.1 mm) |

With Mounting Bracket Attached

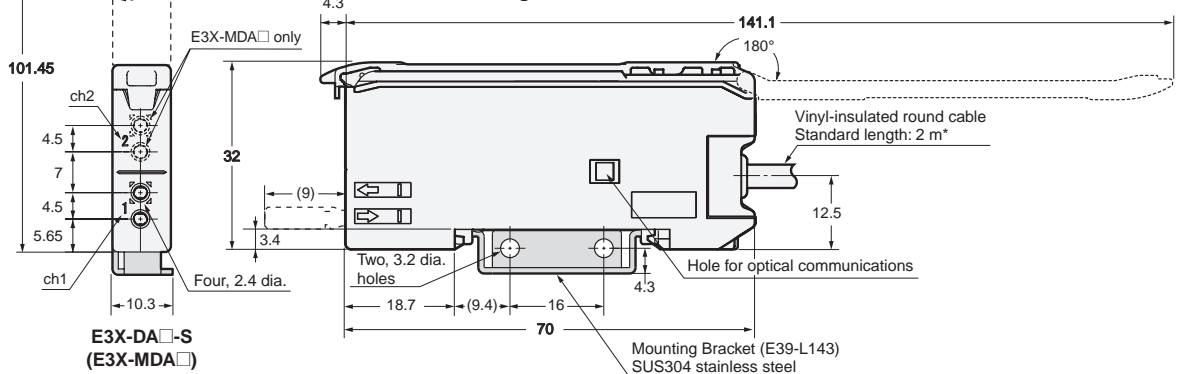

Mounting Holes

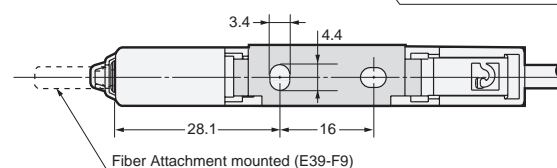
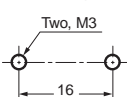

Note: When using E39-L143 Mounting Brackets, there will be small gaps between the Amplifier Units if they are mounted side by side.

Amplifier Units with Wire-saving Connectors

- E3X-DA6-S
- E3X-DA8-S
- E3X-DAG6-S
- E3X-DAG8-S
- E3X-DAB6-S
- E3X-DAB8-S
- E3X-DAH6-S
- E3X-DAH8-S
- E3X-DA6RM-S
- E3X-DA8RM-S
- E3X-DA6TW-S
- E3X-DA8TW-S
- E3X-DA6SE-S
- E3X-DA8SE-S
- E3X-DA6AT-S
- E3X-DA8AT-S
- E3X-MDA6
- E3X-MDA8

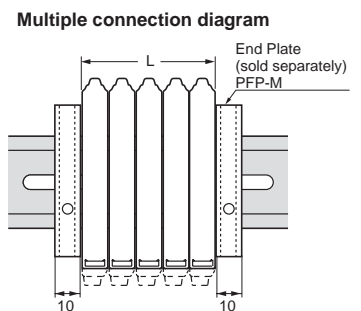
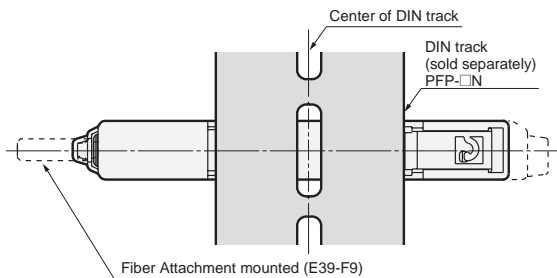
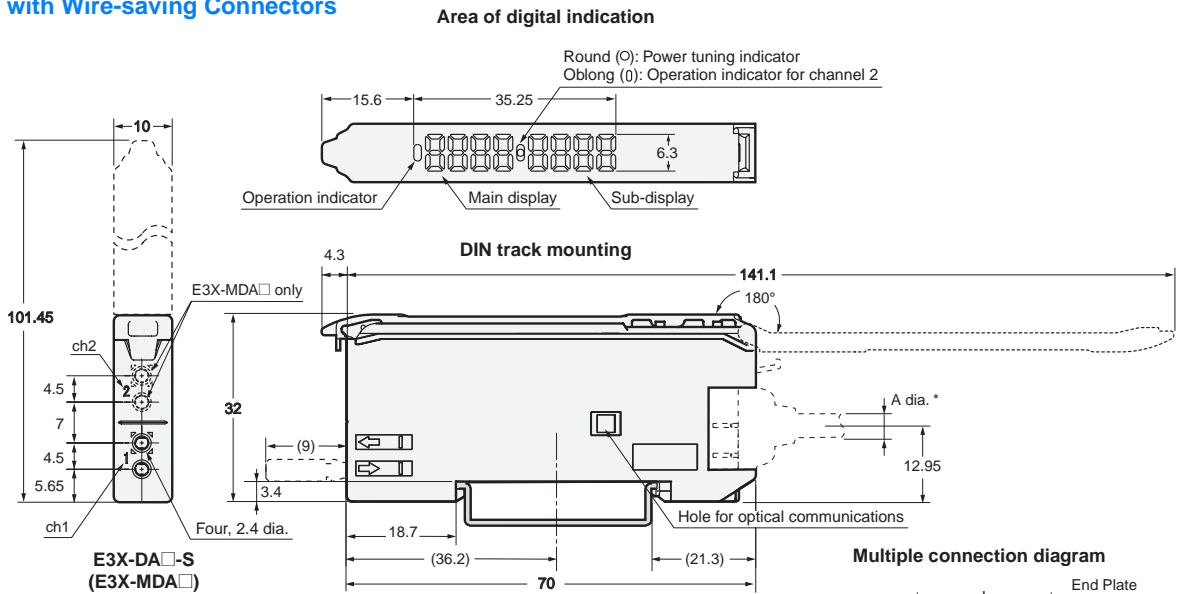

* Cable Diameters

| | |
|-------------------------|-------------|
| E3X-CN22 (2 conductors) | 4.0-mm dia. |
| E3X-CN21 (4 conductors) | |
| E3X-CN11 (3 conductors) | |
| E3X-CN12 (1 conductor) | 2.6-mm dia. |

| The number of expansion | L (mm) |
|-------------------------|--------|
| 1 | 10 |
| 2 | 20 |
| 3 | 30 |
| 4 | 40 |
| 5 | 50 |
| 6 | 60 |
| 7 | 70 |
| 8 | 80 |
| 9 | 90 |
| 10 | 100 |

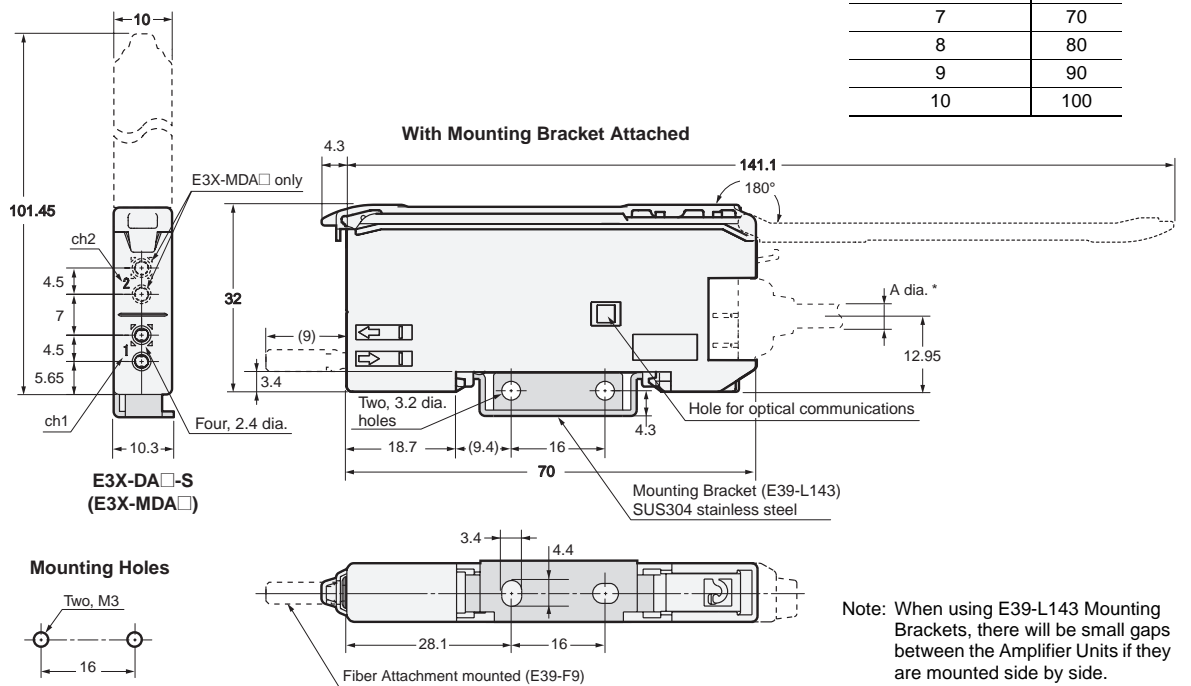

Note: When using E39-L143 Mounting Brackets, there will be small gaps between the Amplifier Units if they are mounted side by side.

Amplifier Unit with Connector for Communications Unit E3X-MDA0

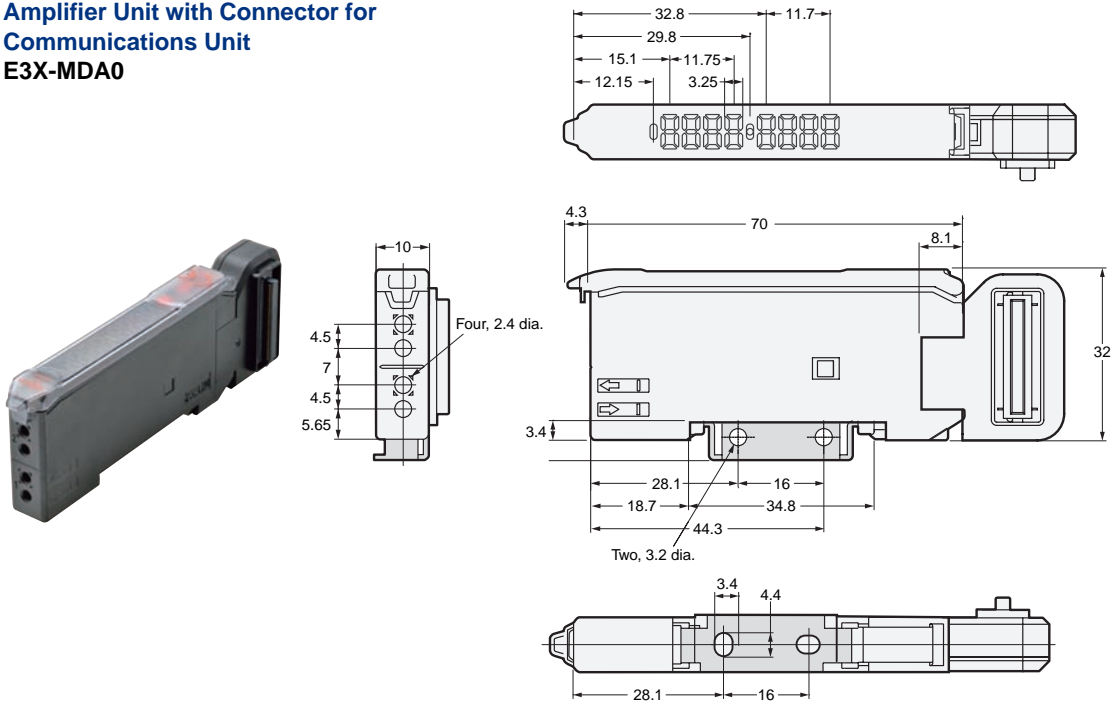

Amplifier Unit Connectors

Master Connectors

E3X-CN11
E3X-CN21

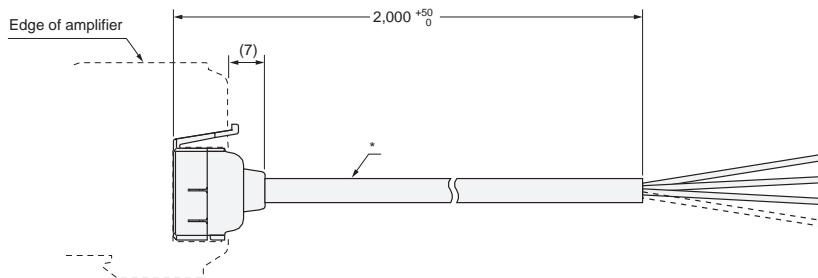

* E3X-CN11: **4 dia. cable / 3 conductors** / Standard length: 2 m (Conductor cross section: 0.2 mm² (AWG24), Insulator diameter: 1.1 mm)
E3X-CN21: **4 dia. cable / 4 conductors** / Standard length: 2 m (Conductor cross section: 0.2 mm² (AWG24), Insulator diameter: 1.1 mm)

Slave Connectors

E3X-CN12
E3X-CN22

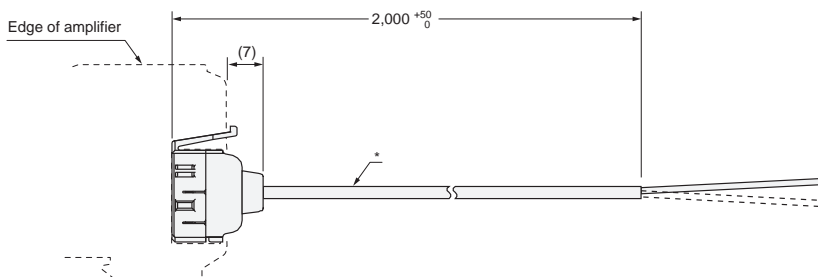

* E3X-CN12: **2.6 dia. cable / 1 conductor** / Standard length: 2 m (Conductor cross section: 0.2 mm² (AWG24), Insulator diameter: 1.1 mm)
E3X-CN22: **4 dia. cable / 2 conductors** / Standard length: 2 m (Conductor cross section: 0.2 mm² (AWG24), Insulator diameter: 1.1 mm)

Read and Understand This Catalog

Please read and understand this catalog before purchasing the products. Please consult your OMRON representative if you have any questions or comments.

Warranty and Limitations of Liability

WARRANTY

OMRON's exclusive warranty is that the products are free from defects in materials and workmanship for a period of one year (or other period if specified) from date of sale by OMRON.

OMRON MAKES NO WARRANTY OR REPRESENTATION, EXPRESS OR IMPLIED, REGARDING NON-INFRINGEMENT, MERCHANTABILITY, OR FITNESS FOR PARTICULAR PURPOSE OF THE PRODUCTS. ANY BUYER OR USER ACKNOWLEDGES THAT THE BUYER OR USER ALONE HAS DETERMINED THAT THE PRODUCTS WILL SUITABLY MEET THE REQUIREMENTS OF THEIR INTENDED USE. OMRON DISCLAIMS ALL OTHER WARRANTIES, EXPRESS OR IMPLIED.

LIMITATIONS OF LIABILITY

OMRON SHALL NOT BE RESPONSIBLE FOR SPECIAL, INDIRECT, OR CONSEQUENTIAL DAMAGES, LOSS OF PROFITS OR COMMERCIAL LOSS IN ANY WAY CONNECTED WITH THE PRODUCTS, WHETHER SUCH CLAIM IS BASED ON CONTRACT, WARRANTY, NEGLIGENCE, OR STRICT LIABILITY.

In no event shall the responsibility of OMRON for any act exceed the individual price of the product on which liability is asserted.

IN NO EVENT SHALL OMRON BE RESPONSIBLE FOR WARRANTY, REPAIR, OR OTHER CLAIMS REGARDING THE PRODUCTS UNLESS OMRON'S ANALYSIS CONFIRMS THAT THE PRODUCTS WERE PROPERLY HANDLED, STORED, INSTALLED, AND MAINTAINED AND NOT SUBJECT TO CONTAMINATION, ABUSE, MISUSE, OR INAPPROPRIATE MODIFICATION OR REPAIR.

Application Considerations

SUITABILITY FOR USE

OMRON shall not be responsible for conformity with any standards, codes, or regulations that apply to the combination of products in the customer's application or use of the products.

At the customer's request, OMRON will provide applicable third party certification documents identifying ratings and limitations of use that apply to the products. This information by itself is not sufficient for a complete determination of the suitability of the products in combination with the end product, machine, system, or other application or use.

The following are some examples of applications for which particular attention must be given. This is not intended to be an exhaustive list of all possible uses of the products, nor is it intended to imply that the uses listed may be suitable for the products:

- Outdoor use, uses involving potential chemical contamination or electrical interference, or conditions or uses not described in this catalog.
- Nuclear energy control systems, combustion systems, railroad systems, aviation systems, medical equipment, amusement machines, vehicles, safety equipment, and installations subject to separate industry or government regulations.
- Systems, machines, and equipment that could present a risk to life or property.

Please know and observe all prohibitions of use applicable to the products.

NEVER USE THE PRODUCTS FOR AN APPLICATION INVOLVING SERIOUS RISK TO LIFE OR PROPERTY WITHOUT ENSURING THAT THE SYSTEM AS A WHOLE HAS BEEN DESIGNED TO ADDRESS THE RISKS, AND THAT THE OMRON PRODUCTS ARE PROPERLY RATED AND INSTALLED FOR THE INTENDED USE WITHIN THE OVERALL EQUIPMENT OR SYSTEM.

PROGRAMMABLE PRODUCTS

OMRON shall not be responsible for the user's programming of a programmable product, or any consequence thereof.

Disclaimers

CHANGE IN SPECIFICATIONS

Product specifications and accessories may be changed at any time based on improvements and other reasons.

It is our practice to change model numbers when published ratings or features are changed, or when significant construction changes are made. However, some specifications of the products may be changed without any notice. When in doubt, special model numbers may be assigned to fix or establish key specifications for your application on your request. Please consult with your OMRON representative at any time to confirm actual specifications of purchased products.

DIMENSIONS AND WEIGHTS

Dimensions and weights are nominal and are not to be used for manufacturing purposes, even when tolerances are shown.

PERFORMANCE DATA

Performance data given in this catalog is provided as a guide for the user in determining suitability and does not constitute a warranty. It may represent the result of OMRON's test conditions, and the users must correlate it to actual application requirements. Actual performance is subject to the OMRON Warranty and Limitations of Liability.

ERRORS AND OMISSIONS

The information in this document has been carefully checked and is believed to be accurate; however, no responsibility is assumed for clerical, typographical, or proofreading errors, or omissions.

2013.1

In the interest of product improvement, specifications are subject to change without notice.

OMRON Corporation
Industrial Automation Company

<http://www.ia.omron.com/>

(c)Copyright OMRON Corporation 2013 All Right Reserved.

Terms and Conditions of Sale

1. **Offer; Acceptance.** These terms and conditions (these "**Terms**") are deemed part of all quotes, agreements, purchase orders, acknowledgments, price lists, catalogs, manuals, brochures and other documents, whether electronic or in writing, relating to the sale of products or services (collectively, the "**Products**") by Omron Electronics LLC and its subsidiary companies ("**Omron**"). Omron objects to any terms or conditions proposed in Buyer's purchase order or other documents which are inconsistent with, or in addition to, these Terms.
2. **Prices; Payment Terms.** All prices stated are current, subject to change without notice by Omron. Omron reserves the right to increase or decrease prices on any unshipped portions of outstanding orders. Payments for Products are due net 30 days unless otherwise stated in the invoice.
3. **Discounts.** Cash discounts, if any, will apply only on the net amount of invoices sent to Buyer after deducting transportation charges, taxes and duties, and will be allowed only if (i) the invoice is paid according to Omron's payment terms and (ii) Buyer has no past due amounts.
4. **Interest.** Omron, at its option, may charge Buyer 1-1/2% interest per month or the maximum legal rate, whichever is less, on any balance not paid within the stated terms.
5. **Orders.** Omron will accept no order less than \$200 net billing.
6. **Governmental Approvals.** Buyer shall be responsible for, and shall bear all costs involved in, obtaining any government approvals required for the importation or sale of the Products.
7. **Taxes.** All taxes, duties and other governmental charges (other than general real property and income taxes), including any interest or penalties thereon, imposed directly or indirectly on Omron or required to be collected directly or indirectly by Omron for the manufacture, production, sale, delivery, importation, consumption or use of the Products sold hereunder (including customs duties and sales, excise, use, turnover and license taxes) shall be charged to and remitted by Buyer to Omron.
8. **Financial.** If the financial position of Buyer at any time becomes unsatisfactory to Omron, Omron reserves the right to stop shipments or require satisfactory security or payment in advance. If Buyer fails to make payment or otherwise comply with these Terms or any related agreement, Omron may (without liability and in addition to other remedies) cancel any unshipped portion of Products sold hereunder and stop any Products in transit until Buyer pays all amounts, including amounts payable hereunder, whether or not then due, which are owing to it by Buyer. Buyer shall in any event remain liable for all unpaid accounts.
9. **Cancellation; Etc.** Orders are not subject to rescheduling or cancellation unless Buyer indemnifies Omron against all related costs or expenses.
10. **Force Majeure.** Omron shall not be liable for any delay or failure in delivery resulting from causes beyond its control, including earthquakes, fires, floods, strikes or other labor disputes, shortage of labor or materials, accidents to machinery, acts of sabotage, riots, delay in or lack of transportation or the requirements of any government authority.
11. **Shipping; Delivery.** Unless otherwise expressly agreed in writing by Omron:
 - a. Shipments shall be by a carrier selected by Omron; Omron will not drop ship except in "break down" situations.
 - b. Such carrier shall act as the agent of Buyer and delivery to such carrier shall constitute delivery to Buyer;
 - c. All sales and shipments of Products shall be FOB shipping point (unless otherwise stated in writing by Omron), at which point title and risk of loss shall pass from Omron to Buyer; provided that Omron shall retain a security interest in the Products until the full purchase price is paid;
 - d. Delivery and shipping dates are estimates only; and
 - e. Omron will package Products as it deems proper for protection against normal handling and extra charges apply to special conditions.
12. **Claims.** Any claim by Buyer against Omron for shortage or damage to the Products occurring before delivery to the carrier must be presented in writing to Omron within 30 days of receipt of shipment and include the original transportation bill signed by the carrier noting that the carrier received the Products from Omron in the condition claimed.
13. **Warranties.** (a) **Exclusive Warranty.** Omron's exclusive warranty is that the Products will be free from defects in materials and workmanship for a period of twelve months from the date of sale by Omron (or such other period expressed in writing by Omron). Omron disclaims all other warranties, express or implied. (b) **Limitations.** OMRON MAKES NO WARRANTY OR REPRESENTATION, EXPRESS OR IMPLIED, ABOUT NON-INFRINGEMENT, MERCHANTABILITY OR FITNESS FOR A PARTICULAR PURPOSE OF THE PRODUCTS. BUYER ACKNOWLEDGES THAT IT ALONE HAS DETERMINED THAT THE PRODUCTS WILL SUITABLY MEET THE REQUIREMENTS OF THEIR INTENDED USE. Omron further disclaims all warranties and responsibility of any type for claims or expenses based on infringement by the Products or otherwise of any intellectual property right. (c) **Buyer Remedy.** Omron's sole obligation hereunder shall be, at Omron's election, to (i) replace (in the form originally shipped with Buyer responsible for labor charges for removal or replacement thereof) the non-complying Product, (ii) repair the non-complying Product, or (iii) repay or credit Buyer an amount equal to the purchase price of the non-complying Product; provided that in no event shall Omron be responsible for warranty, repair, indemnity or any other claims or expenses regarding the Products unless Omron's analysis confirms that the Products were properly handled, stored, installed and maintained and not subject to contamination, abuse, misuse or inappropriate modification. Return of any Products by Buyer must be approved in writing by Omron before shipment. Omron Companies shall not be liable for the suitability or unsuitability or the results from the use of Products in combination with any electrical or electronic components, circuits, system assemblies or any other materials or substances or environments. Any advice, recommendations or information given orally or in writing, are not to be construed as an amendment or addition to the above warranty. See <http://www.omron247.com> or contact your Omron representative for published information.
14. **Limitation on Liability; Etc.** OMRON COMPANIES SHALL NOT BE LIABLE FOR SPECIAL, INDIRECT, INCIDENTAL, OR CONSEQUENTIAL DAMAGES, LOSS OF PROFITS OR PRODUCTION OR COMMERCIAL LOSS IN ANY WAY CONNECTED WITH THE PRODUCTS, WHETHER SUCH CLAIM IS BASED IN CONTRACT, WARRANTY, NEGLIGENCE OR STRICT LIABILITY. Further, in no event shall liability of Omron Companies exceed the individual price of the Product on which liability is asserted.
15. **Indemnities.** Buyer shall indemnify and hold harmless Omron Companies and their employees from and against all liabilities, losses, claims, costs and expenses (including attorney's fees and expenses) related to any claim, investigation, litigation or proceeding (whether or not Omron is a party) which arises or is alleged to arise from Buyer's acts or omissions under these Terms or in any way with respect to the Products. Without limiting the foregoing, Buyer (at its own expense) shall indemnify and hold harmless Omron and defend or settle any action brought against such Companies to the extent based on a claim that any Product made to Buyer specifications infringed intellectual property rights of another party.
16. **Property; Confidentiality.** Any intellectual property in the Products is the exclusive property of Omron Companies and Buyer shall not attempt to duplicate it in any way without the written permission of Omron. Notwithstanding any charges to Buyer for engineering or tooling, all engineering and tooling shall remain the exclusive property of Omron. All information and materials supplied by Omron to Buyer relating to the Products are confidential and proprietary, and Buyer shall limit distribution thereof to its trusted employees and strictly prevent disclosure to any third party.
17. **Export Controls.** Buyer shall comply with all applicable laws, regulations and licenses regarding (i) export of products or information; (ii) sale of products to "forbidden" or other proscribed persons; and (iii) disclosure to non-citizens of regulated technology or information.
18. **Miscellaneous.** (a) **Waiver.** No failure or delay by Omron in exercising any right and no course of dealing between Buyer and Omron shall operate as a waiver of rights by Omron. (b) **Assignment.** Buyer may not assign its rights hereunder without Omron's written consent. (c) **Law.** These Terms are governed by the law of the jurisdiction of the home office of the Omron company from which Buyer is purchasing the Products (without regard to conflict of law principles). (d) **Amendment.** These Terms constitute the entire agreement between Buyer and Omron relating to the Products, and no provision may be changed or waived unless in writing signed by the parties. (e) **Severability.** If any provision hereof is rendered ineffective or invalid, such provision shall not invalidate any other provision. (f) **Setoff.** Buyer shall have no right to set off any amounts against the amount owing in respect of this invoice. (g) **Definitions.** As used herein, "including" means "including without limitation"; and "Omron Companies" (or similar words) mean Omron Corporation and any direct or indirect subsidiary or affiliate thereof.

Certain Precautions on Specifications and Use

1. **Suitability of Use.** Omron Companies shall not be responsible for conformity with any standards, codes or regulations which apply to the combination of the Product in the Buyer's application or use of the Product. At Buyer's request, Omron will provide applicable third party certification documents identifying ratings and limitations of use which apply to the Product. This information by itself is not sufficient for a complete determination of the suitability of the Product in combination with the end product, machine, system, or other application or use. Buyer shall be solely responsible for determining appropriateness of the particular Product with respect to Buyer's application, product or system. Buyer shall take application responsibility in all cases but the following is a non-exhaustive list of applications for which particular attention must be given: (i) Outdoor use, uses involving potential chemical contamination or electrical interference, or conditions or uses not described in this document. (ii) Use in consumer products or any use in significant quantities. (iii) Energy control systems, combustion systems, railroad systems, aviation systems, medical equipment, amusement machines, vehicles, safety equipment, and installations subject to separate industry or government regulations. (iv) Systems, machines and equipment that could present a risk to life or property. Please know and observe all prohibitions of use applicable to this Product. NEVER USE THE PRODUCT FOR AN APPLICATION INVOLVING SERIOUS RISK TO LIFE OR PROPERTY OR IN LARGE QUANTITIES WITHOUT ENSURING THAT THE SYSTEM AS A WHOLE HAS BEEN DESIGNED TO ADDRESS THE RISKS, AND THAT THE OMRON'S PRODUCT IS PROPERLY RATED AND INSTALLED FOR THE INTENDED USE WITHIN THE OVERALL EQUIPMENT OR SYSTEM.
2. **Programmable Products.** Omron Companies shall not be responsible for the user's programming of a programmable Product, or any consequence thereof.
3. **Performance Data.** Data presented in Omron Company websites, catalogs and other materials is provided as a guide for the user in determining suitability and does not constitute a warranty. It may represent the result of Omron's test conditions, and the user must correlate it to actual application requirements. Actual performance is subject to the Omron's Warranty and Limitations of Liability.
4. **Change in Specifications.** Product specifications and accessories may be changed at any time based on improvements and other reasons. It is our practice to change part numbers when published ratings or features are changed, or when significant construction changes are made. However, some specifications of the Product may be changed without any notice. When in doubt, special part numbers may be assigned to fix or establish key specifications for your application. Please consult with your Omron's representative at any time to confirm actual specifications of purchased Product.
5. **Errors and Omissions.** Information presented by Omron Companies has been checked and is believed to be accurate; however, no responsibility is assumed for clerical, typographical or proofreading errors or omissions.

OMRON INDUSTRIAL AUTOMATION • THE AMERICAS HEADQUARTERS

Schaumburg, IL USA • 847.843.7900 • 800.556.6766 • www.omron247.com

OMRON CANADA, INC. • HEAD OFFICE

Toronto, ON, Canada • 416.286.6465 • 866.986.6766 • www.omron247.com

OMRON ELECTRONICS DE MEXICO • HEAD OFFICE

México DF • 52.55.59.01.43.00 • 001.800.556.6766 • mela@omron.com

OMRON ELECTRONICS DE MEXICO • SALES OFFICE

Apodaca, N.L. • 52.81.11.56.99.20 • 001.800.556.6766 • mela@omron.com

OMRON ELETRÔNICA DO BRASIL LTDA • HEAD OFFICE

São Paulo, SP, Brasil • 55.11.2101.6300 • www.omron.com.br

OMRON ARGENTINA • SALES OFFICE

Cono Sur • 54.11.4783.5300

OMRON CHILE • SALES OFFICE

Santiago • 56.9.9917.3920

OTHER OMRON LATIN AMERICA SALES

54.11.4783.5300

OMRON EUROPE B.V. • Wegalaan 67-69, NL-2132 JD, Hoofddorp, The Netherlands. • Tel: +31 (0) 23 568 13 00

Fax: +31 (0) 23 568 13 88 • www.industrial.omron.eu

X-ON Electronics

Largest Supplier of Electrical and Electronic Components

Click to view similar products for [Photoelectric Sensors](#) category:

Click to view products by [Omron](#) manufacturer:

Other Similar products are found below :

[7442AD2X5FRX](#) [EX-19B-LP](#) [EX-19SB-PN](#) [7443AR0X5FRX](#) [7452AD4D4NNX](#) [F3WD052C5M](#) [7655AR-04-F-1-2-RX](#) [7694ADE04DS2X](#)
[FE7C-FRC6S-M](#) [FX-305](#) [PM-R24-R](#) [Q45VR2FPQ](#) [13104RQD07](#) [E3JUXM4MN](#) [E3L2DC4](#) [E3S3LE21](#) [E3SCT11M1J03M](#) [E3SDS20E21](#)
[E3VDS70C43S](#) [E3XNM16](#) [BR23P](#) [HOA6563-001](#) [OJ-3307-30N8](#) [OS-311A-30](#) [P32013](#) [P34036](#) [P43004](#) [P56001](#) [P60001](#) [PB10CNT15PO](#)
[S14132](#) [935286-000](#) [S52101](#) [S56258](#) [SH-21E](#) [EX-L261-P](#) [FD-SN500](#) [FE7B-FDRB6-M](#) [SU-79](#) [T36342](#) [T40300](#) [T60001](#) [PD60CNX20BP](#)
[FX-302-HY](#) [FZS](#) [PM-T64W](#) [PX-22](#) [PZ2-51P](#) [CX-491-P-J](#) [CYNUTX10](#)