

Wire-Saving Amplifiers Offer Remote Teaching, Easy-to-Repeat Settings



- Remote Control models have a unique connector design that allows 16 amplifiers to be connected together
- Revolutionary remote control programmer offers “copy and paste” function for easy settings
- Detachable connector design enables users to replace the amplifier without disturbing wiring and sensing-head installation
- Auto power control function enhances stable detection
- Mark detection model has a blue light source to distinguish tough color combinations
- Three user-selectable displays: digital incident level, digital percent level and LED bar graph display
- Models with dual analog/digital output increase application flexibility



Ordering Information

■ AMPLIFIERS



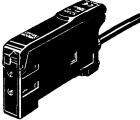

Order connector cables separately for connector-ready models.

Type	Appearance	Applicable connector cables (order separately)	Output	Part number	
				NPN output	PNP output
Remote control amplifiers, digital output models		E3X-CN master and slave cables, single ended, 2 m (6.56 ft) length	ON/OFF output	E3X-DA6	E3X-DA8
Remote control amplifiers, analog/digital output models			ON/OFF output and analog output	E3X-DA7	E3X-DA9
Amplifiers with M8 connector		XS3F single-ended cables and XS3W double-ended cables	ON/OFF output	E3X-DA14V	E3X-DA44V
Amplifiers with cable		Prewired with 2 m (6.56 ft) cable	ON/OFF output	E3X-DA11-N	E3X-DA41-N
			ON/OFF output and analog output	E3X-DA21-N	E3X-DA51-N
Mark-detecting amplifier			ON/OFF output	E3X-DAB11-N	---

■ REMOTE CONTROL PROGRAMMER

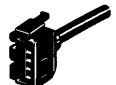
Appearance	Power supply method	Remarks	Part number
	Chargeable battery	Head, cable, and AC adapter are provided as accessories.	E3X-MC11

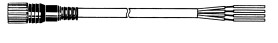
■ CONNECTOR CABLES

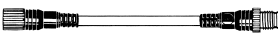

Type	Appearance	Cable length	Amplifier	No. of conductors	Part number
Master connector (See Notes 1, 2)		2 m (6.56 ft)	E3X-DA6, E3X-DA8	3	E3X-CN11
			E3X-DA7, E3X-DA9	4	E3X-CN21
Slave connector (See Notes 1, 2)		2 m (6.56 ft)	E3X-DA6, E3X-DA8	1	E3X-CN12
			E3X-DA7, E3X-DA9	2	E3X-CN22
Straight M8 connector, single ended		2 m (6.56 ft)	E3X-DA14V, E3X-DA44V	4	XS3F-M421-402-A
Right angle M8 connector, single ended		2 m (6.56 ft)	E3X-DA14V, E3X-DA44V	4	XS3F-M422-402-A
Straight M8 connector, double ended		2 m (6.56 ft)	E3X-DA14V, E3X-DA44V	4	XS3W-M421-402-R

Note: 1. When using five E3X-DA6/DA7/DA8/DA9 amplifiers ganged together, order one master and four slave connector cables. The master connector cable distributes a power signal to all the ganged amplifiers; slave connector cables handle output signal transmission only.

Amplifier Units			+	Applicable Connector Cables	
Type	NPN	PNP		Master Connector	Slave Connector
Digital output models	E3X-DA6	E3X-DA8	+	E3X-CN11 (3-wire)	E3X-CN12 (1-wire)
Analog/digital output	E3X-DA7	E3X-DA9		E3X-CN21 (4-wire)	E3X-CN22 (2-wire)
When Using 5 Sets			+		
Amplifier Units (5 Units)				Master Connector (1), Slave Connector (4)	

2. Stickers for Connectors are included as accessories.

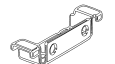
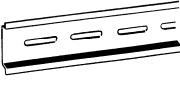
■ ACCESSORIES

Type	Appearance	Remarks	Part number
Mounting bracket		For surface mounting the sensor	E39-L143
DIN rail track		50 cm (1.64 ft) length	PFP-50N
		1 m (3.28 ft) length	PFP-100N
End plate		For DIN track mounting of amplifiers	PFP-M

■ FIBER-OPTIC CABLES

The E3X-DA-N amplifiers use Omron's E32-series fiber-optic cables. With a choice of over 80 sensing heads, you are sure to find one that matches your application requirements. A selection of E32 cables and their respective sensing distances are at the end of this data sheet. Order fiber-optic cables separately.

Specifications

■ AMPLIFIER RATINGS/CHARACTERISTICS

Description		Digital output		Analog/digital output		Mark-detection	M8 connector, digital output
		Prewired	Connector	Prewired	Connector	Prewired	
Output type	NPN output	E3X-DA11-N	E3X-DA6	E3X-DA21-N	E3X-DA7	E3X-DAB11-N	E3X-DA14V
	PNP output	E3X-DA41-N	E3X-DA8	E3X-DA51-N	E3X-DA9	---	E3X-DA44V
Light source (wavelength)		Red LED (660 nm)				Blue LED (470 nm)	Red LED (660 nm)
Power supply voltage		12 to 24 VDC \pm 10%, ripple (p-p) 10% max.					
Power consumption	Normal	960 mW max. (current consumption: 40 mA max. at power supply voltage of 24 VDC)					
	Economy mode	720 mW max. (current consumption: 30 mA max. at power supply voltage of 24 VDC)					
	Digital display not lit	600 mW max. (current consumption: 25 mA max. at power supply voltage of 24 VDC)					
Control output	ON/OFF output	NPN/PNP (depends on model) open collector; load current: 50 mA max.; residual voltage: 1 V max.				NPN open collector; load current: 50 mA max.; residual voltage: 1 V max.	NPN/PNP (depends on model) open collector; load current: 50 mA max.; residual voltage: 1 V max.
	Analog output	---		Load 1 to 5 VDC, 10 k Ω min.		---	---
Operation mode	Switch selectable	Light-ON/Dark-ON operation					
Circuit protection		Reverse polarity, output short-circuit, mutual interference prevention					
Response time by mode	High-speed	250 μ s for operation and reset respectively					
	Standard	1 ms for operation and reset respectively					
	Long distance	4 ms for operation and reset respectively					
Sensitivity setting		Teaching or manual method					
Functions	Timer function	OFF-delay timer range: 0 to 20 ms (set in 1 ms increments); 20 to 200 ms (set in 5 ms increments)					
	Automatic power control (APC)	Fiber-optic current digital control				---	Fiber-optic current digital control
	Zero-reset	Display can be reset to zero when required (negative values can be displayed).					
	Initial reset	Settings can be returned to defaults as required.					
	Monitor focus	---		Upper and lower limits can be set as required for every 100 digital values.		---	---
Display	Function (color)	Operation indicator (orange), 7-segment digital incident level display (red), 7-segment digital incident level percentage display (red), threshold and excess gain 2-color indication bar (green and red), 7-segment digital threshold display (red)					
	Timing	Normal/peak-hold/bottom-hold, program selectable					
	Orientation	Normal/reverse, program selectable					
Optical axis adjustment		Optical axis adjustment possible (flashing function)					
Ambient illumination		Illumination intensity at light-intercepting surface: Incandescent lamp: 10,000 lx max.; Sunlight: 20,000 lx max.					
Ambient temperature	Operating	Groups of 1 to 3 Amplifiers: -25°C to 55°C (-13°F to 131°F) Groups of 4 to 11 Amplifiers: -25°C to 50°C (-13°F to 122°F) Groups of 12 to 16 Amplifiers: -25°C to 45°C (-13°F to 113°F) with no icing or condensation					
	Storage	-30°C to 70°C (-22°F to 158°F) with no icing or condensation					
Ambient humidity		Operating and storage: 35% to 85% with no condensation					
Insulation resistance		20 M Ω min. at 500 VDC					
Dielectric strength		1,000 VAC at 50/60 Hz for 1 minute					
Vibration resistance		10 to 55 Hz with a 1.5-mm double amplitude for 2 hrs each in X, Y and Z directions					

(This table continues on the next page.)

Specifications Table – continued from previous page

Description		Digital output		Analog/digital output		Mark-detection	M8 connector, digital output
		Prewired	Connector	Prewired	Connector	Prewired	
Output type	NPN output	E3X-DA11-N	E3X-DA6	E3X-DA21-N	E3X-DA7	E3X-DAB11-N	E3X-DA14V
	PNP output	E3X-DA41-N	E3X-DA8	E3X-DA51-N	E3X-DA9	---	E3X-DA44V
Shock resistance		500 m/s ² , for 3 times each in X, Y and Z directions					
Degree of protection		IP50					IP66
Connection method		Prewired, standard cable length: 2 m (6.56 ft)	Connector, E3X-CN connector cables	Prewired, standard cable length: 2 m (6.56 ft)	Connector, E3X-CN connector cables	Prewired, standard cable length: 2 m (6.56 ft)	M8 connector; use XS3F or XS3W connector cables
Weight (approx., packed state)		100 g	55 g	100 g	55 g	100 g	100 g
Material	Case	PBT					
	Cover	Polycarbonate					

■ CONNECTOR CABLES

Part number	E3X-CN11/21/22		E3X-CN12
Rated current	2.5 A		
Rated voltage	50 V		
Contact resistance	20 mΩ max. (20 mVDC max., 100 mA max.) (See Note 1)		
No. of insertions	50 times (See Note 2)		
Material	Housing	PBT	
	Contacts	Phosphor bronze/gold-plated nickel	
Weight (approx., packed state)	55 g		25 g

Note: 1. The specified value for the contact resistance pertains to the contact resistance between the Connector and the Amplifier Unit, and the Connector and other neighboring Connectors. It also includes the conductor resistance of the cable.

2. The specified value represents the number of insertions into the Amplifier Unit.

■ REMOTE CONTROL PROGRAMMER

Part number	E3X-MC11
Power supply voltage	Charged with AC adapter
Connection method	Connected via adapter
Weight (approx., packed state)	580 g (complete kit) 120 g (remote control only)

Nomenclature

■ DIGITAL FIBER-OPTIC AMPLIFIER

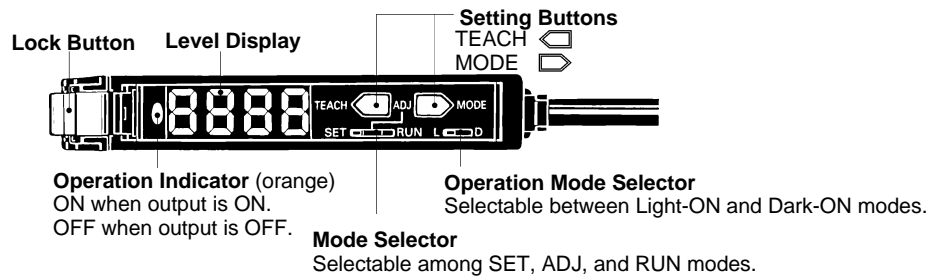

■ DISPLAY AND SPECIAL FUNCTION SETTINGS

Display Setting

The E3X-DA-N offers three display modes, which are Digital Incident Level display, Digital Percent display and Analog display.

- **Digital Incident Level Display:** the incident level is digitally displayed.
- **Digital Percent Display:** the threshold-based excess gain is displayed in percentage.
- **Analog Display:** threshold and excess gain is displayed by two-color (red and green) bar graph.

Special Function Setting

The E3X-DA-N series has various functions that give users more flexibility in meeting a variety of application requirements.

- **Sensing Function:** Enables users to choose either standard sensing distance mode, long sensing distance mode or high speed mode
- **Timer Function:** Enables users to select various OFF-delay timer settings from 0 to 20 ms (set in 1 ms increments) and from 20 to 200 ms (set in 5 ms increments). OFF-delay timer lengthens the duration of a short, high-speed signal so that it can be recognized as input to Programmable Controllers during a scan cycle.
- **Flashing Function:** Flashing red LED allows easier optical axis adjustment.
- **Display Hold Setting:** This function provides easy data reading during optical axis adjustment and high-speed detection by holding the displayed value for a period of time. Displayed data gets updated every 2 seconds. Within the 2-second time frame, the maximum or minimum value is displayed (data will be flashing).
- **Display Orientation Setting:** Reversible digital display provides easy data reading from any mounting orientation.
- **Zero reset:** When activated, this function sets the incident level digital display to zero. This enables operators to easily monitor the difference between the maximum incident level and the minimum incident level.
- **Initial reset:** Enables users to easily program the amplifier back to the default (factory) settings.
- **Monitor focus:** This feature is available on analog/digital output models. Without "monitor focus", the E3X-DA-N has to analyze an incident level range of 0 to 4095 to process a 1 to 5 VDC analog output. With the "monitor focus" function, the E3X-DA-N can narrow the range of the incident level to process a 1 to 5 VDC analog input by defining an upper and lower limit of the incident level. As a result, the sensor's resolution is increased.

Example: Zero reset used to calculate threshold setting

At maximum incident level

0 1200

Shift ↓

0 700

Incident level difference = 700

At minimum incident level

0 500

Zero reset ↓

0 0

0 350

Threshold level is automatically calculated: 350

Example: Monitor focus increases resolution over a narrow range Upper limit = 2400 and lower limit = 1000

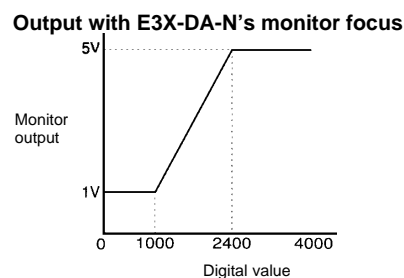
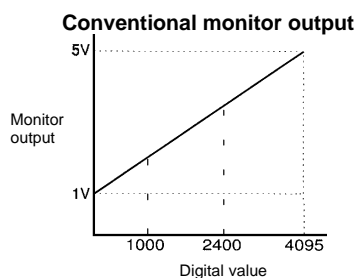

Operation

OUTPUT CIRCUITS

Output	Model	Mode selector	Timing chart	State of output transistor	Output circuit
NPN	E3X-DA11-N E3X-DAB11-N E3X-DA6 E3X-DA14V	LIGHT ON (L/ON)		Light ON	
		DARK ON (D/ON)		Dark ON	
	E3X-DA21-N E3X-DA7	LIGHT ON (L/ON)		Light ON	
		DARK ON (D/ON)		Dark ON	<p>Note: Load resistance: 10 kΩ min.</p>
PNP	E3X-DA41-N E3X-DA8 E3X-DA44V	LIGHT ON (L/ON)		Light ON	
		DARK ON (D/ON)		Dark ON	

(This table continues on the next page.)

Output Circuits – continued from previous page

Output	Model	Mode selector	Timing chart	State of output transistor	Output circuit
PNP	E3X-DA51-N E3X-DA9	LIGHT ON (L/ON)	Incident received Incident not received Operation indicator (orange) ON OFF Output transistor ON OFF Load (relay) Operate Release (Between blue and black)	Light ON	<p>Note: Load resistance: 10 kΩ min.</p>
		DARK ON (D/ON)	Incident received Incident not received Operation indicator (orange) ON OFF Output transistor ON OFF Load (relay) Operate Release (Between blue and black)	Dark ON	

TEACHING FUNCTIONS

Four teaching methods are available to simplify setup and to allow changes in settings on the fly. The E3X-DA-N offers a new feature, "pinpoint teaching" for positioning

Teaching function	Application	Description
Maximum sensitivity setting		Use this function for sensing objects without backgrounds or through-beam sensing. It is ideal for detecting large objects.
Two-point teaching with or without object		Minute level differences as thin as a piece of paper can be detected. Detection of semi-transparent objects or the discrimination of object color is also possible.
One-point teaching without object		Set the sensitivity without stopping objects. This function allows automatic detection of differences between objects and the background. Use it to detect small moving items or thin objects such as gold wire.
Pinpoint teaching for positioning		Allows high precision positioning when detecting electronic components and other small items.

■ MAXIMUM SENSITIVITY SETTING (TEACHING)

Set the mode selector to "SET" to start teaching. The red level display will flash if teaching error occurs. In this case, repeat the entire teaching procedure.

Maximum Sensitivity Setting

1. Set the "SET ADJ RUN" switch to "SET" position.



2. Press the "TEACH" button for 3 seconds (min).

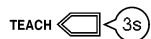

3. Teaching is complete when the level display changes from red to green. Digital incident level will appear shortly after the display changes from red to green.

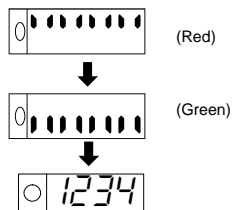

4. Set the "SET ADJ RUN" switch to "RUN" position to implement settings from the teach function.



■ ONE-POINT TEACH MODE (WITHOUT OBJECT)

1. Set the "SET ADJ RUN" switch to "SET" position.



2. Press the "TEACH" button for approximately 1 second.

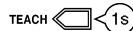
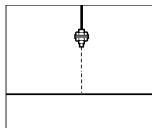

3. Teaching is complete when the red level display is lit. Digital incident level will appear shortly after the red level display is lit.

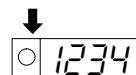

4. Set the "SET ADJ RUN" switch to "RUN" position to implement settings from the teach function.



5. The threshold is automatically set.

Note: Try the two-point teaching mode if the difference in level is too fine.

TWO-POINT TEACH MODE WITH/WITHOUT OBJECT

1. Set the "SET ADJ RUN" switch to "SET" position.



2. Press the "TEACH" button for approximately 1 second when the object is at the sensing position.

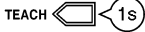
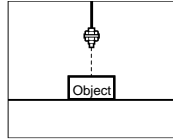

3. The red level display is lit.

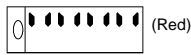

4. Remove the object from the sensing area, and press the "TEACH" button for approximately 1 second.

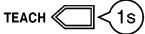
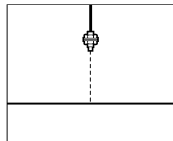

5. Teaching is complete when the green level display is lit. Digital incident level will appear shortly after the green display is lit. (The red level display will flash if a teaching error occurs.)

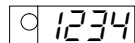

6. Set the "SET ADJ RUN" switch to "RUN" position to implement settings from the teach function.



Note: The order of "with-object" and "without-object" setting procedures above can be reversed.

PINPOINT TEACH MODE (POSITIONING)

1. Set the "SET ADJ RUN" switch to "SET" position.



2. Press the TEACH button for approximately 1 second with no object

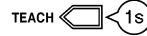
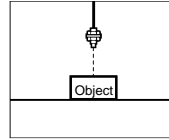

3. The red level display is lit.



4. Place the object in the desired position and press the TEACH button for 3 seconds minimum.

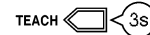
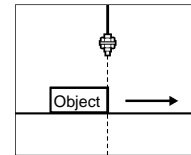

5. Teaching is complete when the green level display is lit. Digital incident level will appear shortly after the green display is lit. (The red level display will flash if a teaching error occurs.)



6. Set the "SET ADJ RUN" switch to "RUN" position to implement settings from the teach function.



■ DISPLAY SETTING

E3X-DA-N can be programmed to display digital incident level, digital percent level or analog display.

1. Set the "SET ADJ RUN" switch to "RUN" position. Digital incident level should appear in the display.

 Factory-set to RUN

2. Press the "MODE" button until "123P" is displayed. Digital percent level is now displayed.

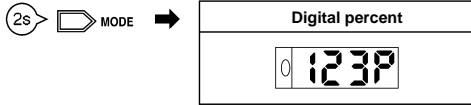

3. Press the "MODE" button to activate the "Analog Incident Level" display. Two color (red and green) bar graph should appear in the display.

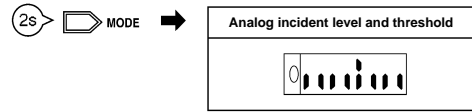

4. Press the "MODE" button to return to the "Digital Incident Level" display.



■ SPECIAL FUNCTION SETTING

E3X-DA-N series has various functions that give users more flexibility in solving a variety of application requirements such as the following:

- Long sensing distance (Sensing Function)
- Faster response time (Sensing Function)
- Off-delay timer (Timer Function)
- Optical axis alignment (Flashing Function)
- Digital data display hold setting (Display Hold Setting)
- Data display orientation (Display Orientation Setting)
- Zero reset
- Initial reset
- Monitor focus

Sensing Function

1. Set the "SET ADJ RUN" switch to "SET" position.



2. Press the "MODE" button until "F5 L" is displayed. The "Standard" sensing function (F5 L) is the default setting. The "Standard" sensing function provides the standard detecting distance. Response time is 1 ms.

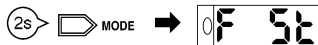

3. Press the "TEACH" button to obtain the "Long Distance" sensing function. "F Ld" should appear on the display. The "Long Distance" function provides a sensing distance that is about 1.3 times that of the "Standard" detecting distance (diffuse fiber in use). The "Long Distance" setting has a response time of 4 ms.

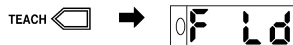

4. Press the "TEACH" button to obtain the "High Speed" sensing function. "F HS" should appear on the display. The "High Speed" function provides a detection distance that is about one-third of the standard distance (diffuse fiber in use). Response time is 250 μs.



5. Press the "TEACH" button to return to the "Standard" sensing function display.

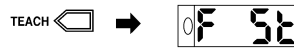

6. Set the "SET ADJ RUN" switch to "RUN" position to implement settings from the teach function.



Timer Function

1. Set the "SET ADJ RUN" Switch to "SET" position.



2. Press the "MODE" button until "L0" is displayed. "L0" is the default setting.

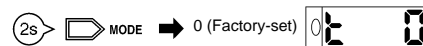

3. Press the "TEACH" button to set to the desired time setting:
1 ms increments from 0 to 20 ms
5 ms increments from 20 to 200 ms

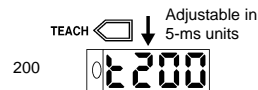

4. Set the "SET ADJ RUN" switch to "RUN" position to implement settings from the teach function.



Flashing Function

1. Set the "SET ADJ RUN" switch to "SET" position.



2. Press the "MODE" button until "LOFF" is displayed. "LOFF" is the default setting.

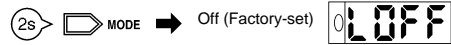

3. Press the "TEACH" button to activate the "flashing" function. Display should read "L On"



4. Press the "TEACH" button to return to the "LOFF" mode.



5. Set the "SET ADJ RUN" switch to "RUN" position to implement settings from the teach function.



Display Hold Setting Function

1. Set the "SET ADJ RUN" switch to "SET" position.



2. Press the "MODE" button until "HOFF" is displayed. "HOFF" is the default setting.

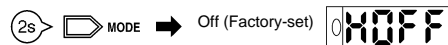

3. Press the "TEACH" button to activate "Peak Hold" display. Displayed data get updated every 2 seconds. The maximum value is displayed.

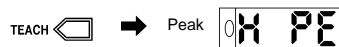

4. Press the "TEACH" button to activate "Bottom Hold" display. Displayed data gets updated every 2 seconds. The minimum value is displayed.

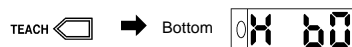

5. Press the "TEACH" button to return to the default setting. "HOFF".

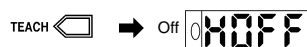

6. Set the "SET ADJ RUN" switch to "RUN" position to implement settings from the teach function.



Display Orientation Setting Function

1. Set the "SET ADJ RUN" switch to "SET" position.



2. Press the "MODE" button until "d123" is displayed. "d123" is the standard setting.

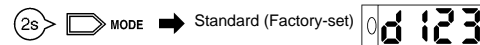

3. Press the "TEACH" button to change the orientation of the display. "dE21" should now appear in the display.



4. Press the "TEACH" button to return to the standard setting, "d123".



5. Set the "SET ADJ RUN" switch to "SET" position to implement settings from the teach function.



MONITOR FOCUS

1. Set the "SET ADJ RUN" switch to "SET" position.



2. Press the "MODE" button until "A-UP" is displayed.

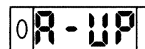

3. Press the "TEACH" button to set the desired "upper limit setting" of the incident level.



4. To set "lower limit setting," press the "MODE" button until "A-LO" is displayed. Press the "TEACH" button to set the lower limit setting.

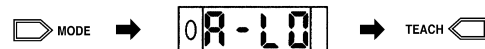

Note: It is not possible to set an "upper limit" that is lower than the value of the "lower limit". Conversely, it is not possible to set a "lower limit" that is greater than the value of the "upper limit"

5. Set the "SET ADJ RUN" switch to "RUN" position to implement settings from the teach function.



■ ZERO RESET FUNCTION

When activated, this function sets the incident level digital display to zero. This enables operators to easily monitor the difference between the maximum and the minimum incident levels.

1. Set the "SET ADJ RUN" switch to "RUN" position.



2. Press the "TEACH" button for 1 second. A zero should appear in the display.

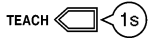

3. Press the "TEACH" and "MODE" buttons simultaneously for 3 seconds to return to the initial incident level display.

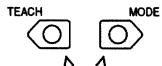

Hold down both for 3 s

■ INITIAL RESET

This function enables users to cancel program input and reset the amplifier back to the default (factory) setting

1. Set the "SET ADJ RUN" switch to "SET" position.



2. Press the "TEACH" and "MODE" buttons simultaneously for 5 seconds until "NO ?" is displayed.

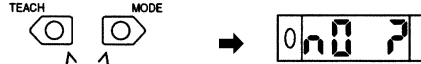

Hold down both for 5 s

To cancel "Initial Reset" function, simply press the "MODE" button.



Press to cancel.

To implement the "Initial Reset" function, first press the "TEACH" button until "YES?" appears in the display.

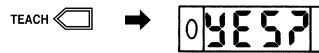

Press the "MODE" button to execute the "Initial Reset" function.



Press to execute initial reset.

3. Set the "SET ADJ RUN" switch to "RUN" position to implement settings from the teach function.



Engineering Data

■ PARALLEL OPERATING RANGE (TYPICAL)

At max. sensitivity. (Use for optical axis adjustment at installation.)

**E32-TC200
(Through-beam)**

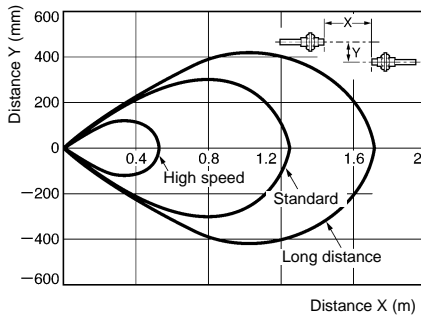

**E32-T11R
(Through-beam)**

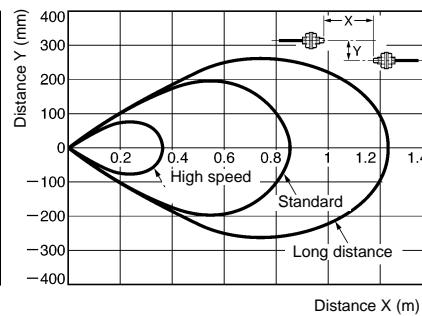

**E32-T11
(Through-beam)**

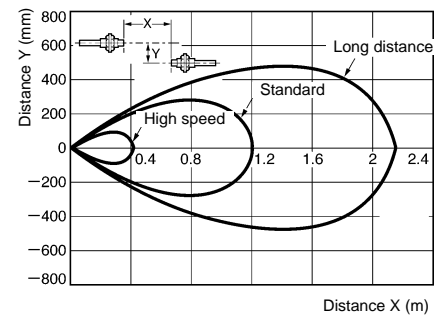

OPERATING RANGE (TYPICAL)

With standard sensing object at max. sensitivity. (Use for the positioning of the object and Sensor.)

E32-DC200 (Reflective)

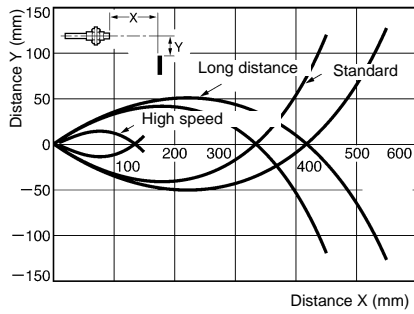

E32-D33 (Reflective)

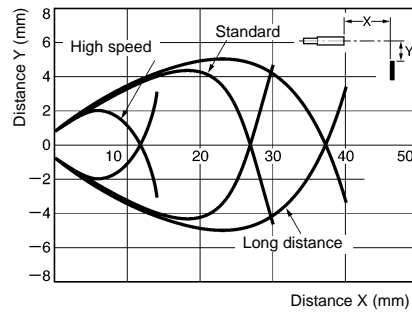

E32-L25L (Convergent Reflective)

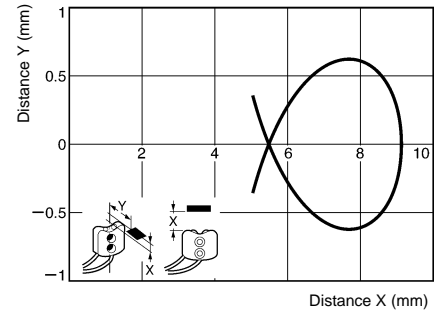

EXCESS GAIN RATIO VS. DISTANCE (TYPICAL)

With standard sensing object. At max. sensitivity.

E32-TC200 (Through-beam)

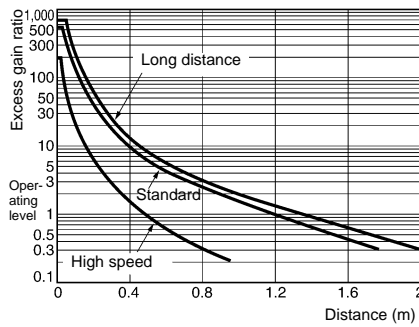

E32-DC200 (Reflective)

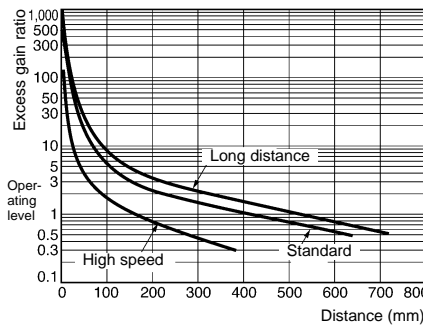

E32-D21L (Reflective)

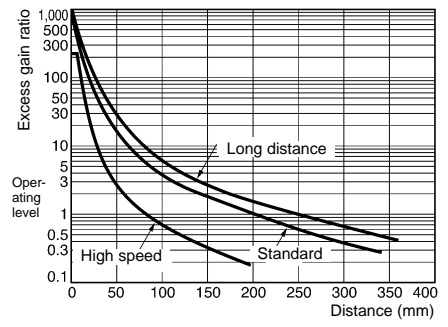

Sensing Distance vs. Operating Range E32-DC200 (Reflective)

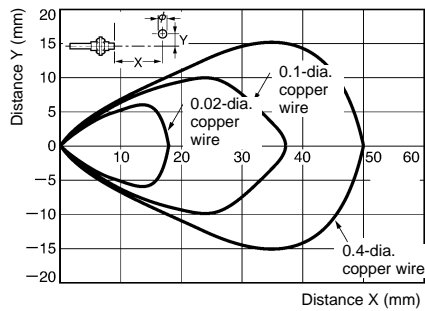

Differential Travel vs. Sensing Distance E32-D11L (Reflective)

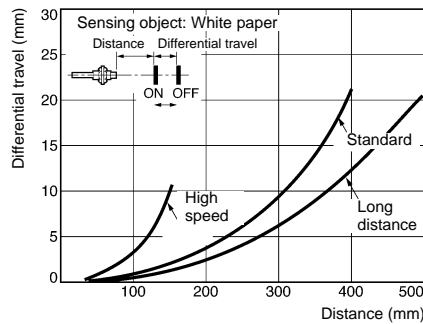

Repeat Accuracy vs. Sensing Distance E32-DC200 (Reflective)

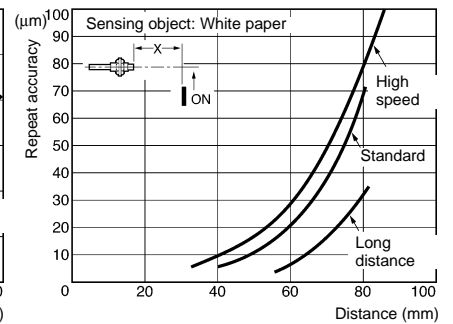

ANALOG OUTPUT VS. DISTANCE (STANDARD MODE)

E32-TC200 (Through-beam)

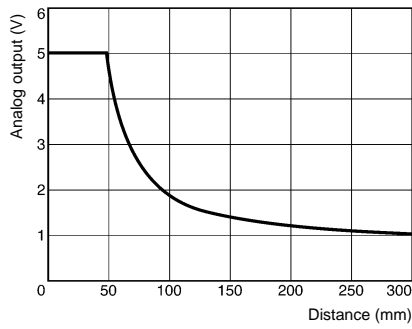

E32-DC200 (Diffuse)

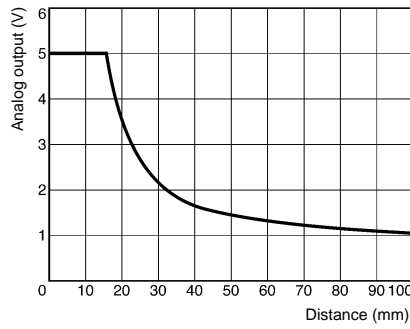

**PARALLEL OPERATING RANGE (TYPICAL)
MARK DETECTION SENSOR E3X-DAB11-N**

At max. sensitivity. (Use for optical axis adjustment at installation.)

E32-TC200 (Through-beam)

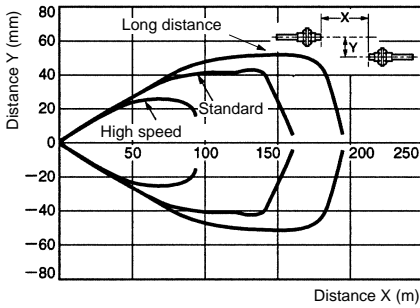

E32-TC200+E39-F1 (Through-beam)

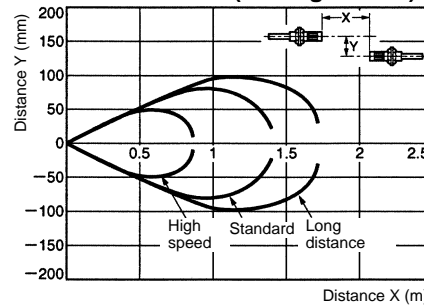

OPERATING RANGE (TYPICAL)

With standard sensing object at max. sensitivity. (Use for the positioning of the object and Sensor.)

E32-DC200 (Reflective)

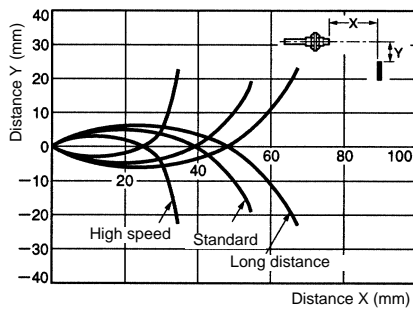

E32-CC200 (Reflective)

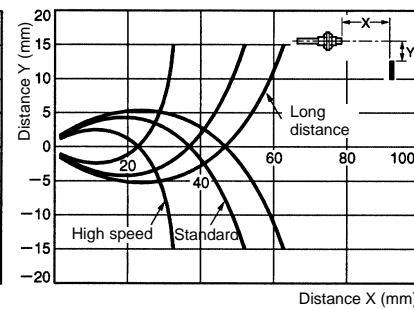

E32-D11L (Convergent Reflective)

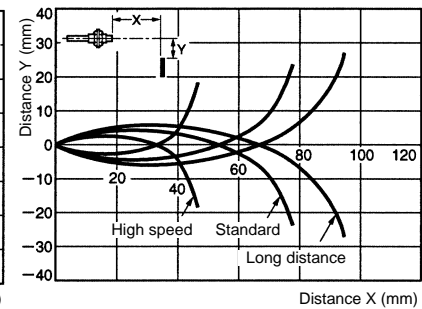

Dimensions

Unit: mm (inch)

■ AMPLIFIERS WITH MALE CONTACTS FOR E3X-CN CONNECTOR CABLES

E3X-DA6
E3X-DA7
E3X-DA8
E3X-DA9

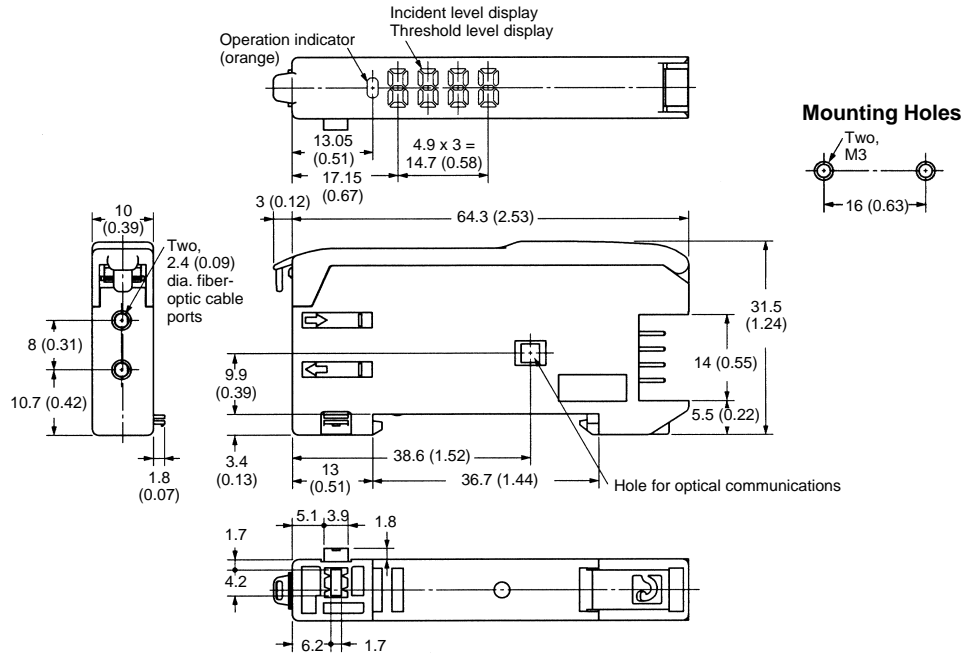
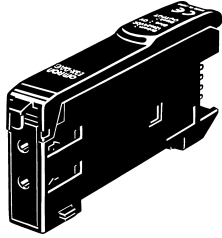

Dimensions with Master Connector Connected

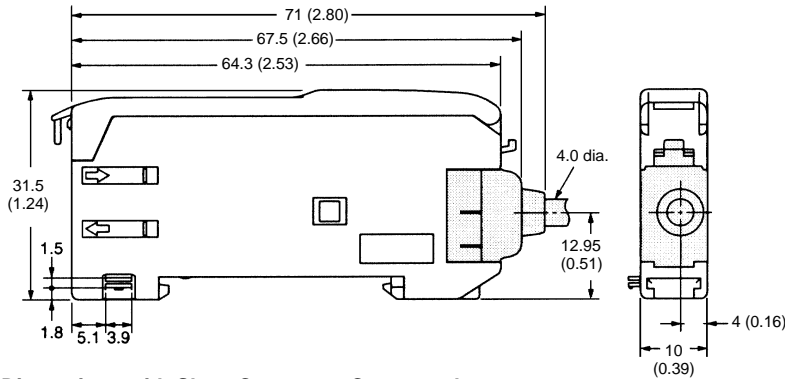

Dimensions with Slave Connector Connected

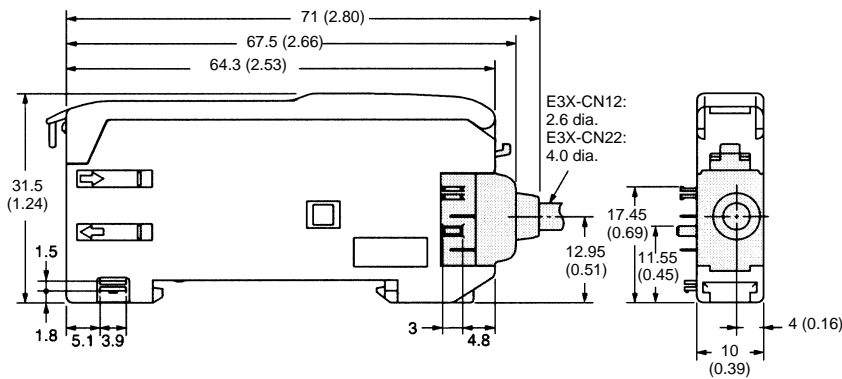

AMPLIFIERS WITH M8 CONNECTORS

Shown with Mounting Bracket attached

Use Omron XS3F and XS3W connector cables or comparable Brad Harrison NanoChange™ cordsets.

**E3X-DA14V
E3X-DA44V**

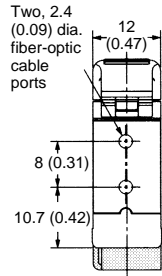
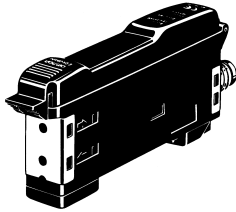

Mounting Holes

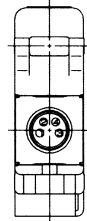
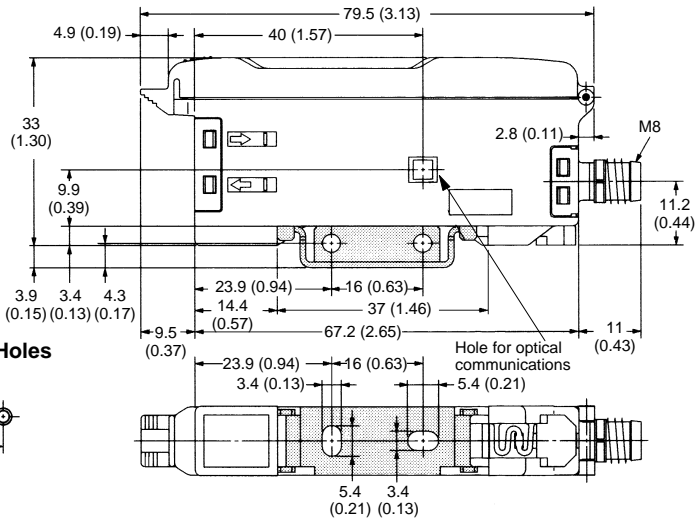
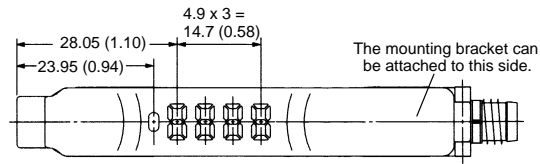
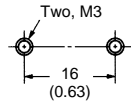

AMPLIFIER PREWIRED WITH CABLE

Shown with Mounting Bracket E39-L143 attached

**E3X-DA11-N
E3X-DA21-N
E3X-DA41-N
E3X-DA51-N
E3X-DAB11-N Mark Detection**

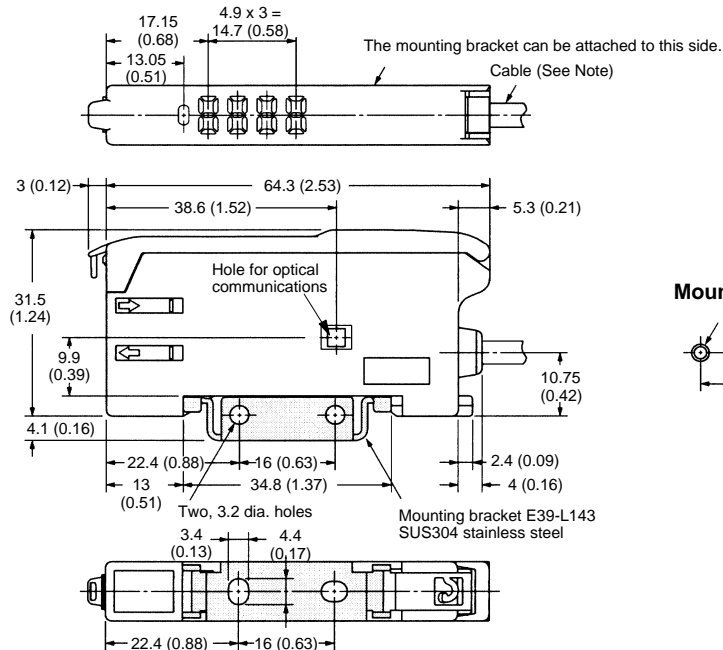
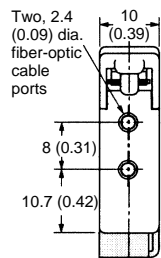
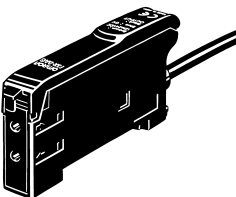

Mounting Holes

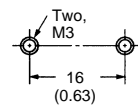

Note: With the E3X-DA11-N/DA41-N/DAB11-N, 4-dia., 3-conductor, vinyl-insulated round cables of cross-sectional area 0.45 mm² and insulation diameter of 1.1 dia. are used.
With E3X-DA21-N/DA51-N, 4-dia., 4-conductor, vinyl-insulated round cables of cross-sectional area 0.2 mm² and insulation diameter 1.1 dia. are used.

CONNECTORS

Master Connectors

E3X-CN11
E3X-CN21

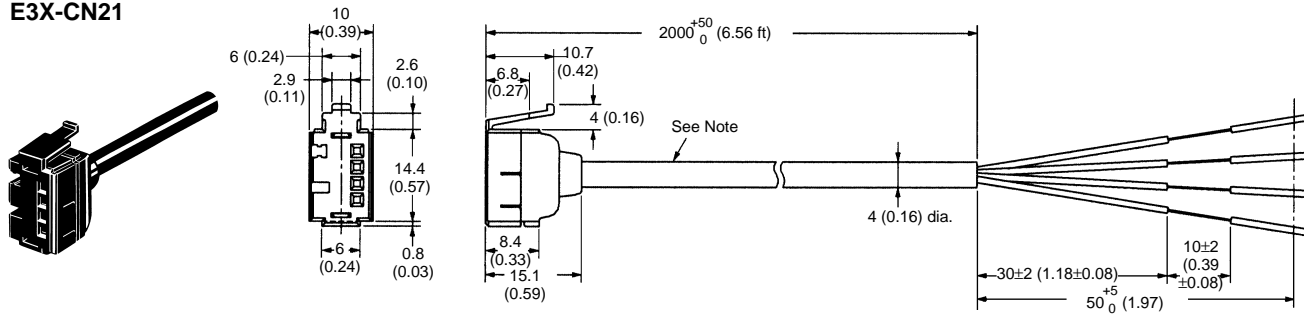

Note: E3X-CN11: 4-dia., 3-conductor, vinyl-insulated round cable of cross-sectional area 0.2 mm² and insulation diameter 1.1 dia.
E3X-CN21: 4-dia., 4-conductor, vinyl-insulated round cable of cross-sectional area 0.2 mm² and insulation diameter 1.1 dia.

Slave Connectors

E3X-CN12
E3X-CN22

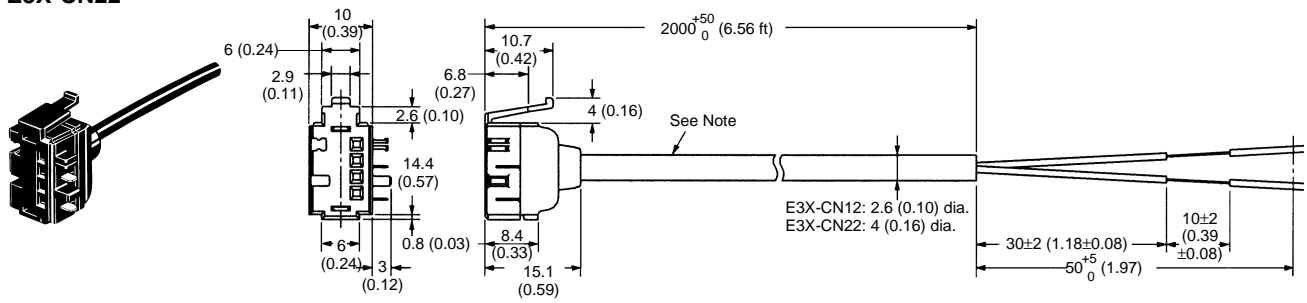

Note: E3X-CN12: 2.6 dia., single-conductor, vinyl-insulated round cable of cross-sectional area 0.2 mm² and insulation dia. 1.1 dia.
E3X-CN22: 4-dia., 2-conductor, vinyl-insulated round cable of cross-sectional area 0.2 mm² and insulation diameter 1.1 dia.

■ REMOTE CONTROL PROGRAMMER

E3X-MC11

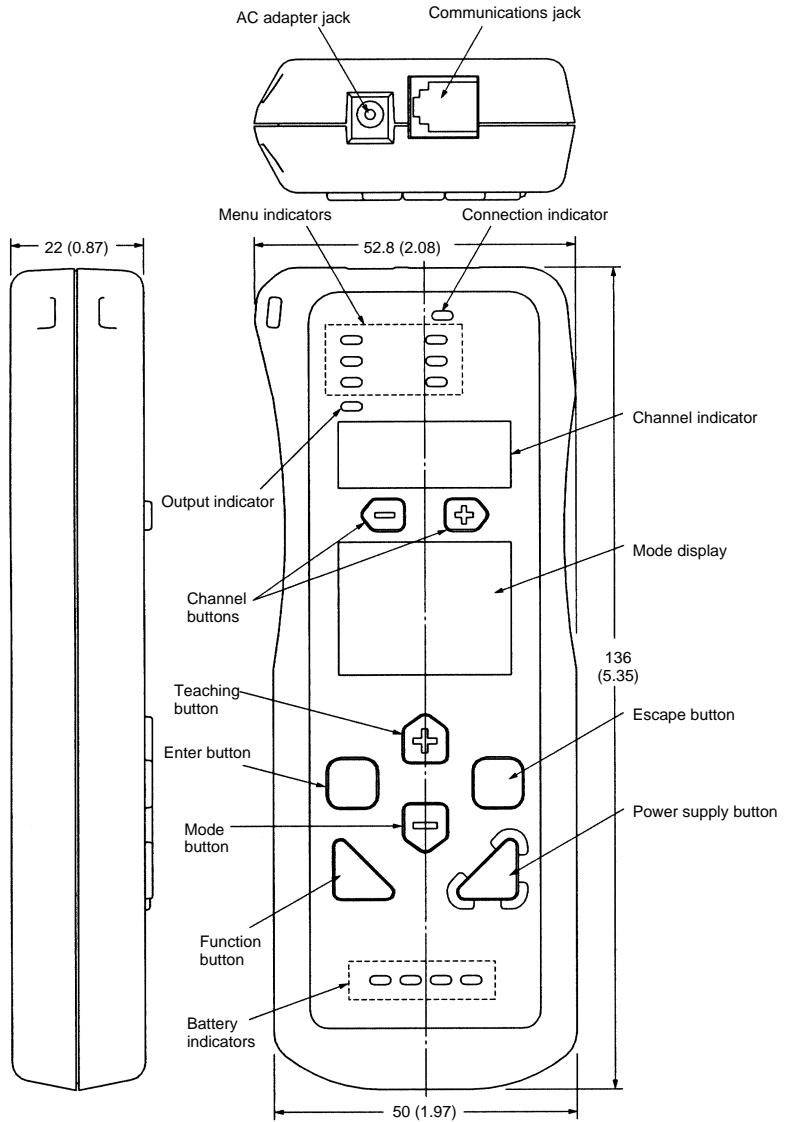

Optical Communication Head for Remote Control (included)

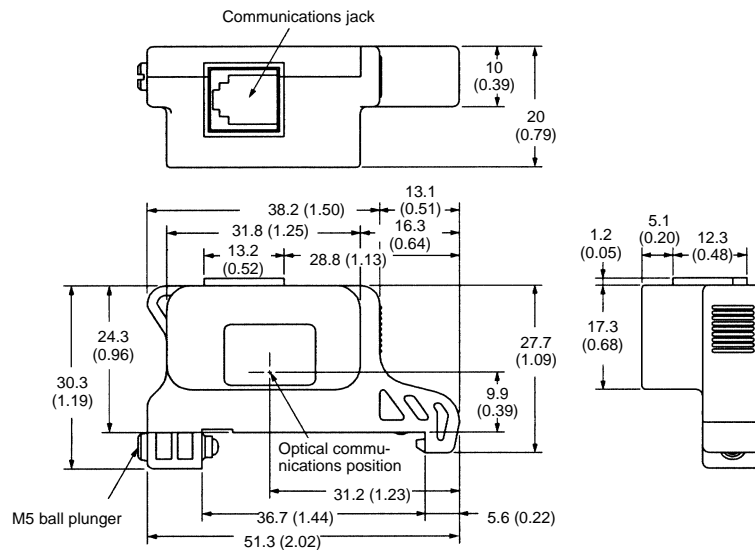
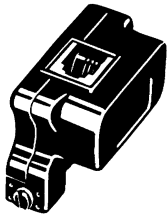

■ ACCESSORIES (ORDER SEPARATELY)

Mounting Bracket E39-L143

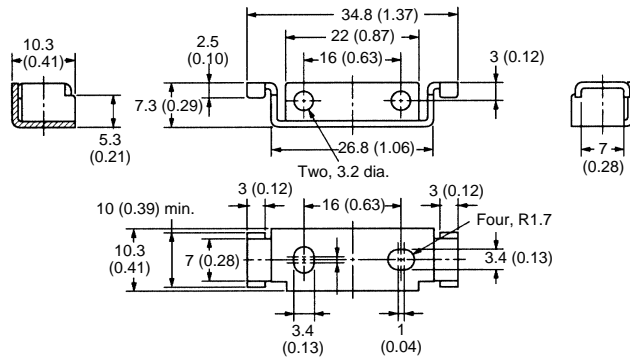
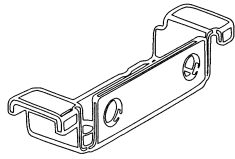

End Plate PFP-M

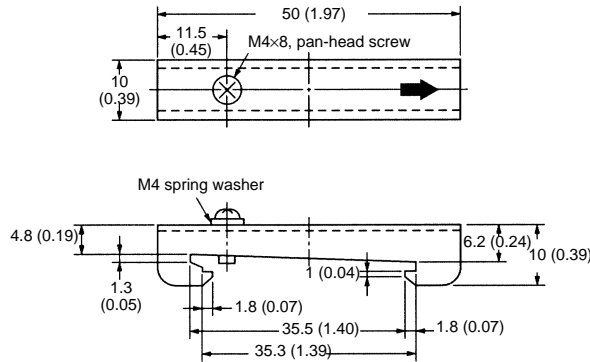
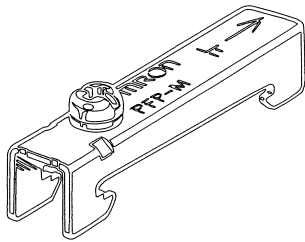

Installation

■ CONNECTION

Connection with K3NX-VD2□ Process Meter

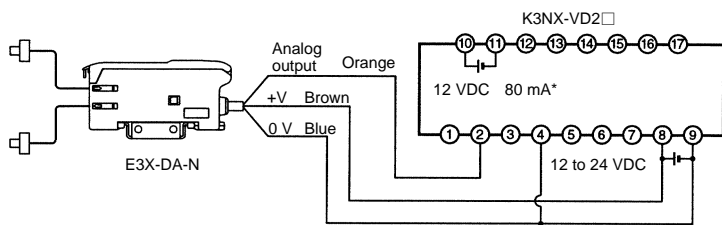

*Use this service power supply for the Sensor with reference to the power consumption of each Sensor.

- Note:
1. Various output boards are available for the K3NX. Select an appropriate output type per application requirements.
 2. For details about the K3NX, refer to the *K3NX Data Sheet* in Omron's *Digital Panel Meters* catalog or the *K3NX Operation Manual (N090)*.
 3. This wiring is for the K3NX with DC power supply specifications and the Analog/Digital Sensor with DC power supply specifications. Check respective power supply specifications before wiring.

■ MOUNTING

Joining Amplifier Units

1. Mount the Amplifier Units one at a time onto the DIN rail.

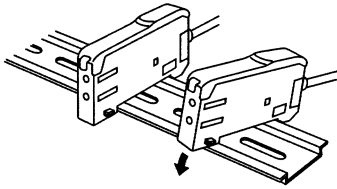

2. Line up the clips and slide the Amplifier Units together, and then press the units together until they click into place.

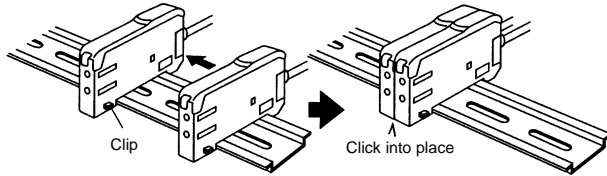

Separating Amplifier Units

Slide Amplifier Units away from each other, and remove from the DIN rail one at a time. (Do not attempt to remove Amplifier Units from the DIN rail without separating them first.)

- Note:
1. The specifications for ambient temperature will vary according to the number of Amplifier Units used together. For details, refer to *Ratings/Characteristics*.
 2. Always turn OFF the power supply before joining or separating Amplifier Units.

Mounting the Optical Communication Head

Allow 20 mm (0.79 in) of space to mount the Optical Communication Head on the DIN rail between a cabinet wall and the first Amplifier Unit. For proper operation, position the Optical Communication Head close to the nearest Amplifier Unit, so there is less than a 5 mm (0.20 in) gap.

Allow 20 mm (0.79 in) to mount the Optical Communication Head on DIN rail.

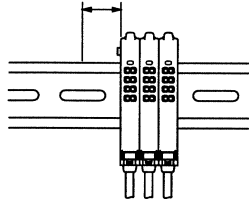

Mounting

1. Mount the front part of the Amplifier Unit onto mounting bracket E39-L143 (included) or onto DIN rail.
2. Press the back part onto the mounting bracket or onto the DIN rail.

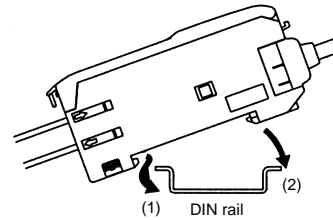

Removal

Pull the lock tab of the Amplifier Unit with a flat blade screwdriver in direction (3) and lift the fiber insertion part in direction (4) as shown below.

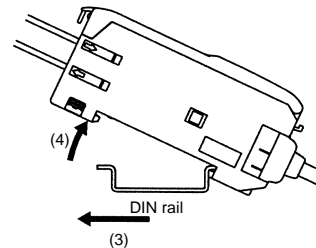

In the case of side mounting, attach the E39-L143 mounting bracket on the Amplifier Unit first, and secure the Amplifier Unit with M3 screws and washers. The diameter of the washers should be no more than 6 mm.

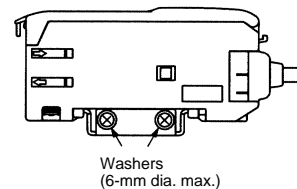

Precautions

■ AVOID DAMAGE TO THE E3X-DA-N

- Voltage must not exceed the rated voltage of the E3X-DA-N.
- When supplying power to the E3X-DA-N, make sure that the polarity of the power is correct.
- Do not short-circuit the load connected to the E3X-DA-N.
- Do not impose 100 VAC or more on models that operate with DC.
- Do not use the E3X-DA-N in environments where flammable or explosive gas exists.
- Do not disassemble, repair or modify the E3X-DA-N.
- The E3X-DA-N has an enclosure rating of IP50; do not immerse in water.
- Load must be connected to the E3X-DA-N.

■ INSTALLATION

Power Reset Time

- The E3X-DA-N is ready to sense objects 100 ms after the unit is turned on.
- If power is supplied to the E3X-DA-N and the load independently, make sure to turn ON the E3X-DA-N first.
- When the E3X-DA-N is turned ON or OFF, the operation indicator will be illuminated for an instant, but no control output will be turned ON.

Power Supply

- Do not connect the E3X-DA-N to a full-wave or half-wave rectified power supply.
- When a standard switching power supply is used, the frame ground (FG) and the ground (G) terminal must be grounded. Otherwise, the E3X-DA-N may experience noise problem.

■ WIRING

Cable

- The cable can be extended up to 100 m provided the wire thickness is at least 0.3 mm².
- Do not pull cables with pulling force exceeding 50N.

Avoid Damage or Malfunction Due to Induction Noise

- Never run the E3X-DA-N cables in the same conduit with power lines or high tension cables.

■ ADJUSTMENT

Mutual Interference Protection Function

There may be some instability in the digital display values due to light from other sensors. If this occurs, increase the sensitivity (i.e., decrease the threshold) to perform stable detection.

EEPROM Writing Error

If the data is not written to the EEPROM correctly due to a power failure during teaching or static-electric noise, repeat the whole teaching procedure.

Optical Communications

Several Amplifier Units can be slid together and used in groups. Do not, however, slide the Amplifier Units or attempt to remove any of the Amplifier Units during operation.

Hysteresis Adjustment

The hysteresis setting can be adjusted using the Remote Control Programmer. Do not, however, set the hysteresis to a value lower than the factory setting. Using a setting less than the factory setting may result in incorrect operation.

■ OTHERS

Typical Values

Minimum sensing object and characteristic data values are typical values checked on actual products selected at random. None of these values represent a guaranteed rating or performance value.

■ FIBER UNIT

Mounting

Tightening Force

The tightening force applied to the sensing head should be as follows:

Threaded Model

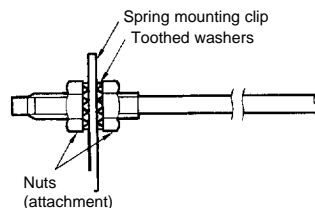

Unthreaded Model

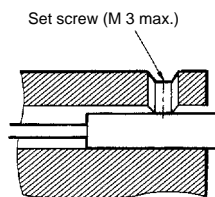

Sensing head	Tightening torque
M3/M4 screw	0.78 N • m max.
M6 screw/ 6-mm dia. column	0.98 N • m max.
1.5-mm dia. column	0.2 N • m max.
2-mm dia./3-mm dia. column	0.29 N • m max.
E32-T12F 5-mm dia. Teflon model	0.78 N • m max.
E32-D12F 6-mm dia. Teflon model	
E32-T16	0.49 N • m max.
E32-R21	0.59 N • m max.
E32-M21	Up to 5 mm to the tip: 0.49 N • m max. More than 5 mm from the tip: 0.78 N • m max.
E32-L25A	0.78 N • m max.
E32-T16P E32-T24S E32-L24L E32-L25L	0.29 N • m max.

Use a proper-sized wrench.

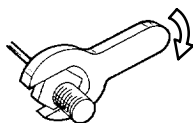

Fiber Connection and Disconnection

The E3X amplifier has a lock button. Connect or disconnect the fibers to or from the E3X amplifier using the following procedures:

1. Connection

Remove the protective cover, insert the fiber into the amplifier, and lower the lock button until a click is heard.

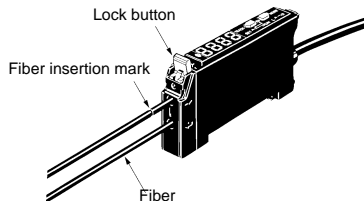

After cutting the fiber using the E39-F4 Fiber Cutter, put an insertion mark on the fiber as a guide for correct insertion into the amplifier, and then insert the fiber up to this mark.

2. Disconnection

Remove the protective cover and raise the lock button to pull out the fiber.

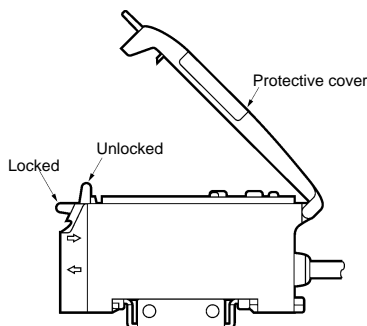

Note: Remove the protective cover and raise the lock lever to pull out the fiber. (Before removing the fiber, be sure to confirm that the lock is released so as to maintain the fiber properties.)

3. Precautions for Fiber Connection/Disconnection

Be sure to lock or unlock the lock button within an ambient temperature range between -10°C and 40°C .

■ FIBER INSERTION

Make sure that the fiber is fully inserted in the amplifier. The sensing distance may decrease if the fiber is not fully inserted.

Standard 2.2-mm dia. Fiber

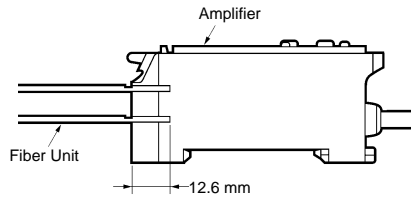

Thin Fiber with the E39-F9 Attachment

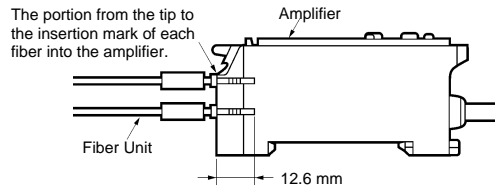

Fiber with Fixed Length

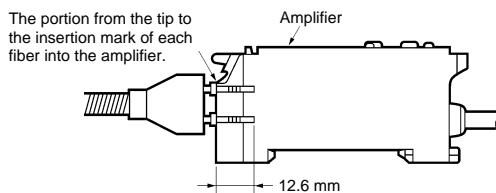

■ CUTTING FIBER

Insert a fiber into the Fiber Cutter and determine the length of the fiber to be cut.

Press down the Fiber Cutter in a single stroke to cut the fiber.

An insertion mark can be placed on the fiber to serve as a reference when inserting the fiber into the amplifier. Use the following procedure.

Confirm through the cutter hole that the fiber is inserted beyond the insertion mark hole so that the insertion mark is properly indicated, and then press firmly down on the cutter.

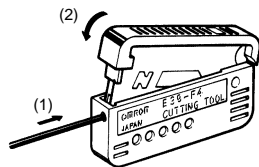

Insert the fiber into the amplifier up to the insertion mark. Proper fiber performance will not be achieved unless the fiber is inserted all the way to the insertion mark. (This method is applicable to standard, 2.2-mm-dia. fibers only.)

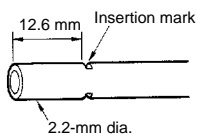

The cutting holes cannot be used twice. If the same hole is used twice, the cutting face of the fiber will be rough and the sensing distance will be reduced. Always use a new hole.

Use either one of the two holes on the right (refer to the following figure) to cut a thin fiber as follows:

1. An attachment is temporarily fitted to a thin fiber before shipment.

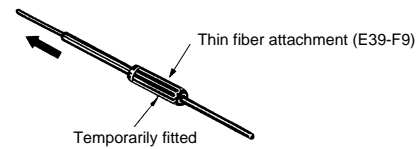

2. Secure the attachment after adjusting the position of the thin fiber in the direction indicated by the arrow.



3. Insert the fiber to be cut into the E39-F4.

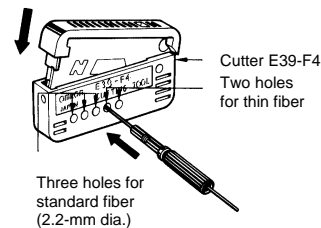

4. Finished state (proper cutting state)



Note: Insert the fiber in the direction indicated by the arrow.

Connection

Do not pull or press the fiber units. The fiber units have a withstand force of 9.8 N to 29.4 N (pay utmost attention because the fibers are thin).

Do not bend the fiber unit beyond the permissible bending radius.

Do not bend the edge of the fiber units (excluding the E32-T□R and E32-D□R).

Correct

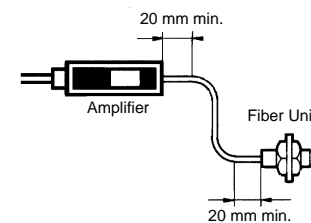

Incorrect

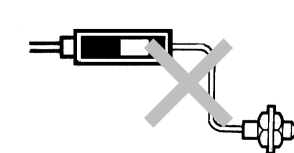

Note: Do not apply excess force on Fiber units.

Correct

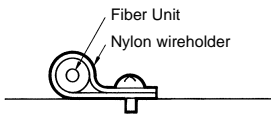

Incorrect

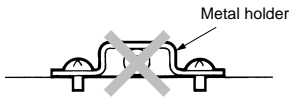

Excessive vibration can break the fiber head. Use the following method to prevent fiber head breakage.

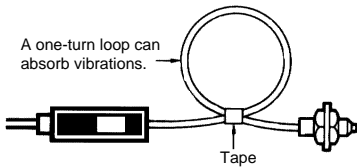

Bending Radius

E39-F11 Sleeve Bender

The bending radius of the stainless steel tube should be as large as possible. The smaller the bending radius becomes, the shorter the sensing distance will be.

Insert the tip of the stainless steel tube to the Sleeve Bender and bend the stainless steel tube slowly along the curve of the Sleeve Bender (refer to the figure).

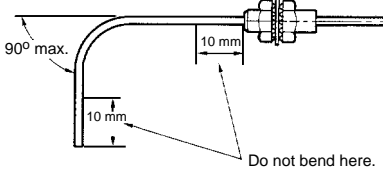
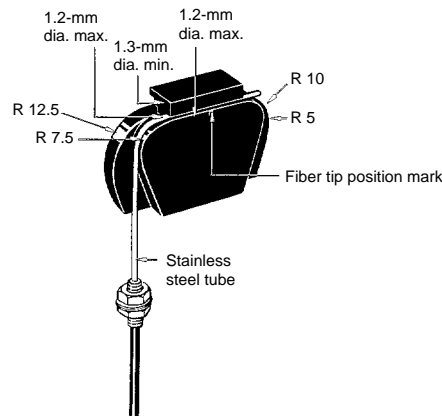

E39-F32 Protective Spiral Tubes

Insert a fiber to the protective spiral tube from the head connector side (screwed) of the tube.

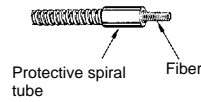

Push the fiber into the protective spiral tube. The tube should be straight so that the fiber is not twisted when inserted. Then turn the end cap of the spiral tube.

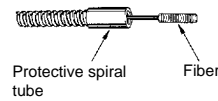

Secure the protective spiral tube on a suitable place with the attached nut.

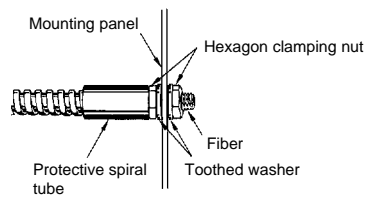

Use the attached saddle to secure the end cap of the protective spiral tube. To secure the protective spiral tube at a position other than the end cap, apply tape to the tube so that the portion becomes thicker in diameter.

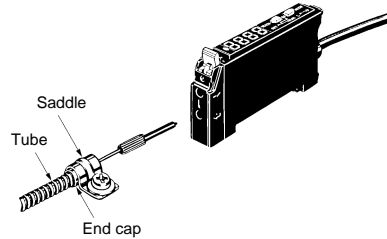

E39-F10 Fiber Connector

Mount the fiber connector as shown in the following illustrations

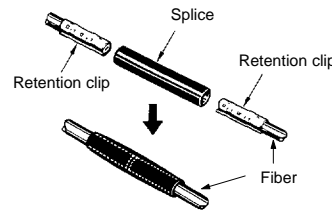

Each fiber unit should be as close as possible before they are connected.

Sensing distance will be reduced by approximately 25% when fibers are connected.

Only 2.2-mm-dia. fibers can be connected.

CONNECTORS

Mounting Connectors

1. Insert the Master or Slave Connector into the Amplifier Unit until it clicks into place.

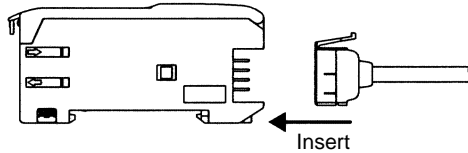

2. Join Amplifier Units together as required after all the Master and Slave Connectors have been inserted.
3. Attach the stickers (provided as accessories) to the sides of Master and Slave Connectors that are not connected to other Connectors.

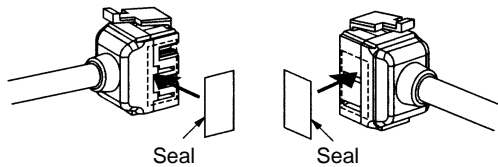

Note: Attach the stickers to the sides with grooves.

Removing Connectors

1. Slide the Amplifier Unit away from the rest of the group.
2. After the desired Amplifier Unit(s) has been separated from the group, press down on the Connector lever and remove it. (Do not attempt to remove Connectors without separating them from other Amplifier Units first.)

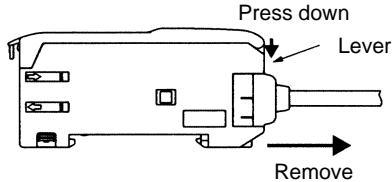

Mounting End Plate

Depending on how it is mounted, an Amplifier Unit may move during operation. In this case, use an End Plate.

Before mounting an End Plate, remove the clip from the Master Amplifier Unit using a nipper or similar tool.

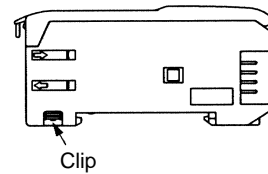

The clip can also be removed using the following mechanism, which is incorporated in the construction of the section underneath the clip.

1. Insert the clip that is to be removed into the slit underneath the clip on another Amplifier Unit.

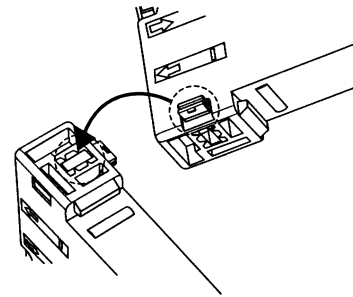

2. Remove the clip by rotating the Amplifier Unit.

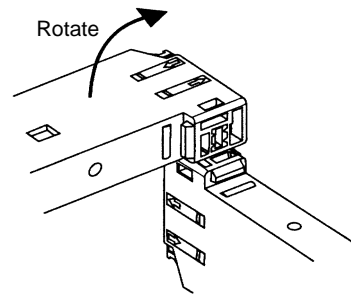

When using the E3X-DA-N with the Remote Control Programmer, mount the End Plate in the way shown below.

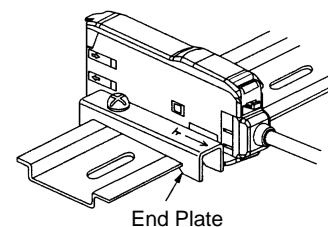

Pull Strength for Connectors (Including Cables)

E3X-CN11, E3X-CN21, E3X-CN22: 30 N max.
E3X-CN12: 12 N max.



Sensing Distance with Fiber-optic Cables

THROUGH-BEAM FIBERS

 : Long-distance mode
  : Standard mode
  : High-speed mode

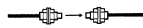
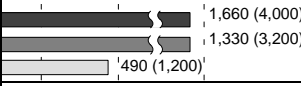
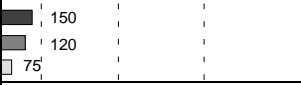
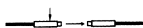
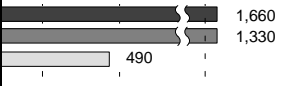
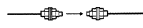
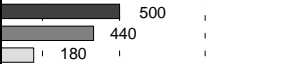
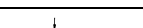
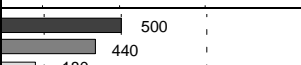
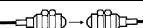
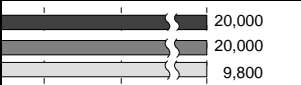
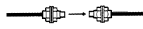
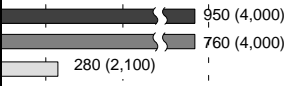
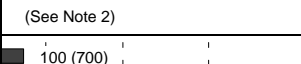
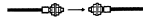
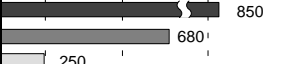
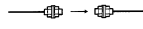

- “Standard object” measurements were made with E3X-DA-N set to Standard mode. The size of standard object is the same as the fiber core diameter or the lens diameter for models with a lens.
- “Minimum sensing object” is shown in parentheses below the standard object. The minimum sensing object size was determined when the E3X-DA-N amplifier received light that exceeded a light incident value of 1000 (set to digital incident level display).

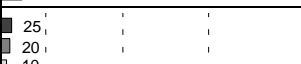
✂ Indicates models that customers can cut to length for their application. Models without this mark are pre-cut by the factory to maintain their respective specifications.

Application	Feature	Appearance	Applicable amplifier unit	Sensing distance (mm) (Values in parentheses when using the E39-F1 Lens Kit)	Standard object (Minimum sensing object: opaque)	Part number	Permissible bending radius
Long distance	M4		E3X-DA□-N	 1,660 (4,000) 1,330 (3,200) 490 (1,200)	1.4-mm dia. (0.02-mm dia.)	E32-T11L ✂	25 mm
			E3X-DAB11-N	 150 120 75			
	3 mm dia.		E3X-DA□-N	 1,660 1,330 490	1.4-mm dia. (0.01-mm dia.)	E32-T12L ✂	
	M3		E3X-DA□-N	 500 440 180	0.9-mm dia. (0.01-mm dia.)	E32-T21L ✂	
	2 mm dia.; small diameter		E3X-DA□-N	 500 440 180		E32-T22L ✂	
	M14 with lens; ideal for explosion-proof applications		E3X-DA□-N	 20,000 20,000 9,800 (See Note 1)	10-mm dia. (0.01-mm dia.)	E32-T17L ✂	
General-purpose	M4		E3X-DA□-N	 950 (4,000) 760 (4,000) 280 (2,100) (See Note 2)	1.0-mm dia. (0.01-mm dia.)	E32-TC200 ✂	
			E3X-DAB11-N	 100 (700) 75 (550) 45 (350)			
	M3; possible to mount the reflective side-view conversion attachment (E39-F5)		E3X-DA□-N	 850 680 250		E32-TC200A ✂	
	M3; for detecting minute sensing objects		E3X-DA□-N	 250 220 90	0.5-mm dia. (0.01-mm dia.)	E32-TC200E ✂	
			E3X-DAB11-N	 25, 20, 10,			











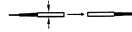

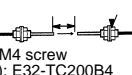

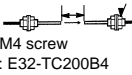

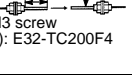

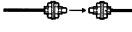
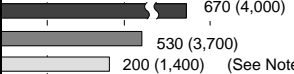
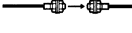
Note: 1. The E32-T17L allows a longer sensing distance in Standard and Long-distance modes because its optical fiber length is 10 m.
 2. These models allow a longer sensing distance in Standard and Long-distance modes because their optical fiber length is 2 m.

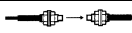
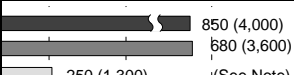
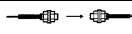
Through-beam fibers – continued from previous page

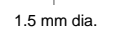
 : Long-distance mode
  : Standard mode
  : High-speed mode

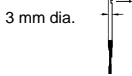
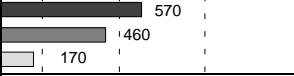
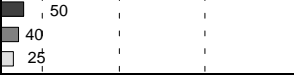
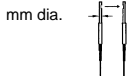

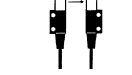
- “Standard object” measurements were made with E3X-DA-N set to Standard mode. The size of standard object is the same as the fiber core diameter or the lens diameter for models with a lens.
- “Minimum sensing object” is shown in parentheses below the standard object. The minimum sensing object size was determined when the E3X-DA-N amplifier received light that exceeded a light incident value of 1000 (set to digital incident level display).

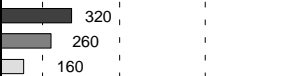
✂ Indicates models that customers can cut to length for their application. Models without this mark are pre-cut by the factory to maintain their respective specifications.

Application	Feature	Appearance	Applicable amplifier unit	Sensing distance (mm) (Values in parentheses when using the E39-F1 Lens Kit)	Standard object (Minimum sensing object: opaque)	Part number	Permissible bending radius
Thin fiber	2-mm dia.; for detecting minute objects		E3X-DA□-N	 250 220 90	0.5-mm dia. (0.01-mm dia.)	E32-T22 ✂	25 mm
	1.2-mm dia.; with sleeve	 M4 screw (): E32-TC200B4	E3X-DA□-N	 950 760 280	1.0-mm dia. (0.01-mm dia.)	E32-TC200B ✂ E32-TC200B4 ✂	25 mm
	1.2-mm dia.; with sleeve	 M4 screw (): E32-TC200B4	E3X-DAB11-N	 100 75 45	1.0-mm dia. (0.01-mm dia.)	E32-TC200B ✂ E32-TC200B4 ✂	25 mm
	0.9-mm dia.; with sleeve	 M3 screw (): E32-TC200F4	E3X-DA□-N	 250 220 90	0.5-mm dia. (0.01-mm dia.)	E32-TC200F ✂ E32-TC200F4 ✂	25 mm
Flexible (resists breaking)	Can be bent like electrical wires (R1)		E3X-DA□-N	 670 (4,000) 530 (3,700) 200 (1,400) (See Note)	1.0-mm dia. (0.01-mm dia.)	E32-T11R ✂	1 mm
			E3X-DA□-N	 150 130 50	0.5-mm dia. (0.01-mm dia.)	E32-T21R ✂	
	Ideal for mounting on moving sections (R4)		E3X-DA□-N	 850 (4,000) 680 (3,600) 250 (1,300) (See Note)	1.0-mm dia. (0.01-mm dia.)	E32-T11 ✂	4 mm
			E3X-DA□-N	 220 200 80	0.5-mm dia. (0.01-mm dia.)	E32-T21 ✂	
		 1.5 mm dia.	E3X-DA□-N	 220 200 80	0.5-mm dia. (0.01-mm dia.)	E32-T22B ✂	
Side-view	Long distance; space-saving	 3 mm dia.	E3X-DA□-N	 570 460 170	1.0-mm dia. (0.01-mm dia.)	E32-T14L ✂	25 mm
			E3X-DAB11-N	 50 40 25			
	Suitable for detecting minute objects	 1 mm dia.	E3X-DA□-N	 150 130 55	0.5-mm dia. (0.01-mm dia.)	E32-T24 ✂	
Screw-mounting type		E3X-DA□-N	 4,000 3,400 1,250	4.0-mm dia. (0.01-mm dia.)	E32-T14 ✂		
		E3X-DAB11-N	 320 260 160				



Note: These models allow a longer sensing distance in Long-distance mode because their optical fiber length is 2 m.

SPECIAL-PURPOSE THROUGH-BEAM FIBERS

 : Long-distance mode
  : Standard mode
  : High-speed mode

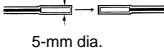
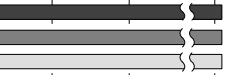
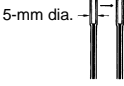
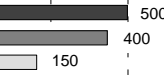
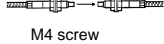

- “Standard object” measurements were made with E3X-DA-N set to Standard mode. The size of standard object is the same as the fiber core diameter or the lens diameter for models with a lens.
- “Minimum sensing object” is shown in parentheses below the standard object. The minimum sensing object size was determined when the E3X-DA-N amplifier received light that exceeded a light incident value of 1000 (set to digital incident level display).

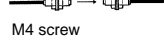
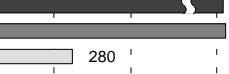
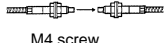
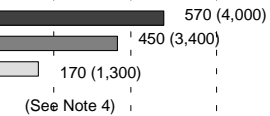
✂ Indicates models that customers can cut to length for their application. Models without this mark are pre-cut by the factory to maintain their respective specifications.

Application	Feature	Appearance	Applicable amplifier unit	Sensing distance (mm) (Values in parentheses when using the E39-F1 Lens Kit)	Standard object (Minimum sensing object: opaque)	Part number	Permissible bending radius
Chemical resistant	Teflon-covered *1; withstands chemicals and harsh environments; Operating ambient temperature: -30°C to 70°C (-22°F to 158°F)	 5-mm dia.	E3X-DA□-N	 3,800 3,000 1,100	4.0-mm dia. (0.01-mm dia.)	E32-T12F ✂	40 mm
	Side view Teflon-covered *1; withstands chemicals and harsh environments; Operating ambient temperature: -30°C to 70°C (-22°F to 158°F)	 5-mm dia.	E3X-DA□-N	 500 400 150	3.0-mm dia. (0.01-mm dia.)	E32-T14F ✂	
Heat-resistant	Resists 200°C; flexible (R10); fiber sheath material: Teflon *1; Operating ambient temperature: -40°C to 200°C (-40°F to 392°F)	 M4 screw	E3X-DA□-N	 350 280 100	1.0-mm dia. (0.01-mm dia.)	E32-T61R	10 mm
	Resists 150°C *2; fiber sheath material: fluoro-resin; Operating ambient temperature: -40°C to 150°C (-40°C to 302°F)	 M4 screw	E3X-DA□-N	 950 760 280	1.5-mm dia. (0.01-mm dia.)	E32-T51 ✂	35 mm
	Resists 300°C *3, with spiral tube; high mechanical strength; fiber sheath material: stainless steel; Operating ambient temperature: -40°C to 300°C (-40°F to 572°F)	 M4 screw	E3X-DA□-N	 570 (4,000) 450 (3,400) 170 (1,300) (See Note 4)	1.0-mm dia. (0.01-mm dia.)	E32-T61	25 mm







- Note:
1. Teflon is a registered trademark of the Dupont Company and the Mitsui Dupont Chemical Company for their fluoride resin.
 2. For continuous operation, use the products within the temperature ranging from -40°C to 130°C (-40°F to 266°F).
 3. Indicates the heat-resistant temperature at the fiber tip
 4. This model allows a longer sensing distance in Long-distance mode because the optical fiber length is 2 m.

Special-purpose through-beam fibers – continued from previous page

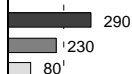
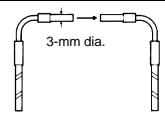
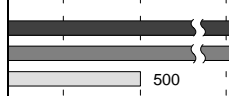
 : Long-distance mode
  : Standard mode
  : High-speed mode

- “Standard object” measurements were made with E3X-DA-N set to Standard mode. The size of standard object is the same as the fiber core diameter or the lens diameter for models with a lens.
- “Minimum sensing object” is shown in parentheses below the standard object. The minimum sensing object size was determined when the E3X-DA-N amplifier received light that exceeded a light incident value of 1000 (set to digital incident level display).

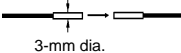
✂ Indicates models that customers can cut to length for their application. Models without this mark are pre-cut by the factory to maintain their respective specifications.

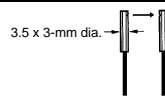
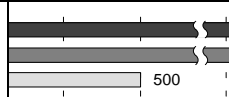
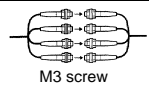
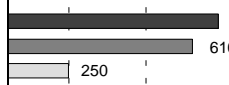
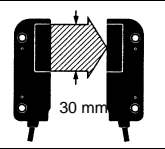
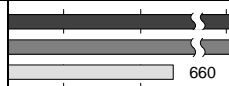
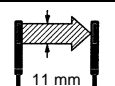
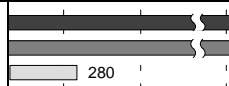
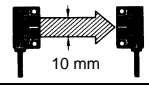
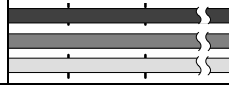
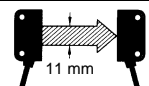
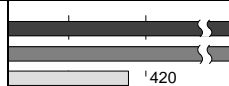

Application	Feature	Appearance	Applicable amplifier unit	Sensing distance (mm) (Values in parentheses when using the E39-F1 Lens Kit)	Standard object (Minimum sensing object: opaque)	Part number	Permissible bending radius
Heat-resistant	Side-view; resists 150°C *1; Detects minute targets; fiber sheath material: fluororesin; Operating ambient temperature: -40°C to 150°C (-40°F to 302°F)		E3X-DA□-N		1.0-mm dia. (0.01-mm dia.)	E32-T54 ✂	35 mm
	Resists 200°C (392°F) *2; L-shaped; fiber sheath material: stainless steel		E3X-DA□-N		1.7-mm dia. (0.01-mm dia.)	E32-T84S	25 mm
Slot	Suitable for film sheet detection; no optical axis adjustment required; easy to mount		E3X-DA□-N		4.0-mm dia. (0.16-mm dia.)	E32-G14 ✂	25 mm
			E3X-DAB11-N				
Narrow vision field	Suitable for detecting wafers;		E3X-DA□-N		1.7-mm dia. (0.01-mm dia.)	E32-T22S ✂	10 mm
	Side-view; suitable for detecting wafers		E3X-DA□-N		2.0-mm dia. (0.01-mm dia.)	E32-T24S ✂	10 mm
Area sensing	Multi-point detection (4-head)		E3X-DA□-N		2.0-mm dia. (0.01-mm dia.)	E32-M21	25 mm
	Detects in a 30-mm area		E3X-DA□-N		(0.3-mm dia.) *3	E32-T16W ✂	10 mm
	Side-view; suitable for applications with limited spatial depth		E3X-DA□-N		(0.2-mm dia.)	E32-T16J ✂	10 mm
Area sensing	Suitable for detecting over a 10-mm area; long distance		E3X-DA□-N		(0.6-mm dia.) *3	E32-T16 ✂	25 mm
	Stable detection for minute objects in a wide area; degree of protection: IP50		E3X-DA□-N		(0.2-mm dia.) *3	E32-T16P ✂	10 mm

Note: 1. For continuous operation, use the products within the temperature ranging from -40°C to 130°C (-40°F to 266°F)

2. Indicates the heat-resistant temperature at the fiber tip.



3. These figures are for a sensing distance of 100 mm and for detecting over a 10-mm area, or 11-mm area for the E32-T16. (Figures for the diameter of sensing objects are in the still state.)

■ DIFFUSE FIBERS

 : Long-distance mode
  : Standard mode
  : High-speed mode

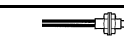
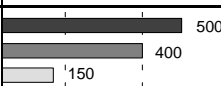
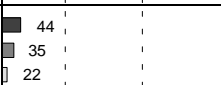
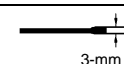
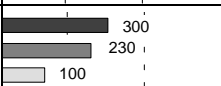
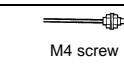
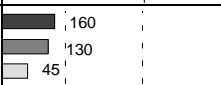
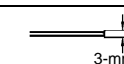
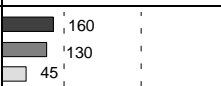
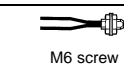
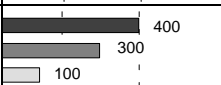
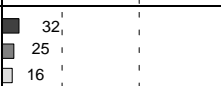
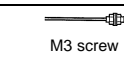
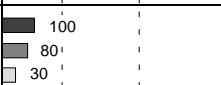
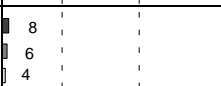
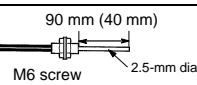
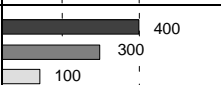
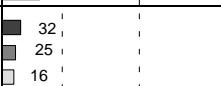
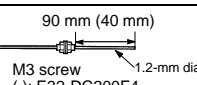
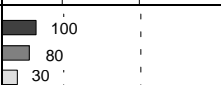

- “Standard object” measurements were made with E3X-DA-N set to Standard mode.
- “Minimum sensing object” is shown in parentheses below the standard object. The values of the minimum sensing object were obtained at a distance where the smallest object (gold wire) can be sensed with the Diffuse Fiber Unit.
- The E3X-DA-N may continue to receive internal reflective light when it is set to the maximum sensitivity setting. In this case, set the amplifier to “two-point teaching with or without-object teaching.”

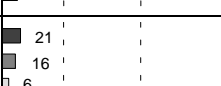
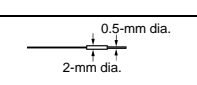
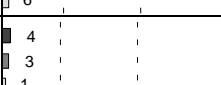
✂ Indicates models that customers can cut to length for their application. Models without this mark are pre-cut by the factory to maintain their respective specifications.

Application	Features	Appearance	Applicable amplifier unit	Sensing distance (mm) (Values measured using white paper)	Standard object (Min. sensing object)	Part number	Permissible bending radius
Long distance	M6	 M6 screw	E3X-DA□-N		500 × 500 (0.01-mm dia.)	E32-D11L ✂	25 mm
			E3X-DAB11-N*		(0.1-mm dia.)		
	3-mm dia.; small diameter	 3-mm dia.	E3X-DA□-N		300 × 300 (0.01-mm dia.)	E32-D12 ✂	
	M4	 M4 screw	E3X-DA□-N		200 × 200 (0.01-mm dia.)	E32-D21L ✂	
3-mm dia.; small diameter			 3-mm dia.	E3X-DA□-N			E32-D22L ✂
General-purpose	M6	 M6 screw	E3X-DA□-N		400 × 400 (0.01-mm dia.)	E32-DC200 ✂	25 mm
			E3X-DAB11-N*		(0.1-mm dia.)		
	M3; small diameter	 M3 screw	E3X-DA□-N		100 × 100 (0.01-mm dia.)	E32-DC200E ✂	
			E3X-DAB11-N*		(0.2-mm dia.)		
Thin fiber	2.5-mm dia.; with sleeve	 90 mm (40 mm) M6 screw (): E32-DC200B4	E3X-DA□-N		400 × 400 (0.01-mm dia.)	E32-DC200B ✂ E32-DC200B4 ✂	25 mm
			E3X-DAB11-N*				
	1.2-mm dia.; with sleeve	 90 mm (40 mm) M3 screw (): E32-DC200F4	E3X-DA□-N		100 × 100 (0.01-mm dia.)	E32-DC200F ✂ E32-DC200F4 ✂	
	Minute object detection (0.8-mm dia.)	 3-mm dia. 0.8-mm dia.	E3X-DA□-N		25 × 25 (0.01-mm dia.)	E32-D33 ✂	
Minute object detection (0.5-mm dia.)	 2-mm dia. 0.5-mm dia.	E3X-DA□-N		E32-D331 ✂			

Note: *For this color mark amplifier with blue LED light source, only minimum object size is provided.

Diffuse fibers – continued from previous page



 : Long-distance mode
  : Standard mode
  : High-speed mode

- “Standard object” measurements were made with E3X-DA-N set to Standard mode.
- “Minimum sensing object” is shown in parentheses below the standard object. The values of the minimum sensing object were obtained at a distance where the smallest object (gold wire) can be sensed with the Diffuse Fiber Unit.
- The E3X-DA-N may continue to receive internal reflective light when it is set to the maximum sensitivity setting. In this case, set the amplifier to “two-point teaching with or without-object teaching.”

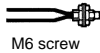
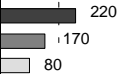
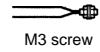
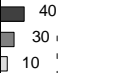
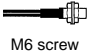
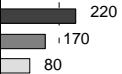
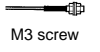
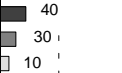
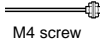
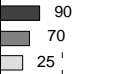
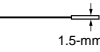
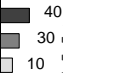
✂ Indicates models that customers can cut to length for their application. Models without this mark are pre-cut by the factory to maintain their respective specifications.











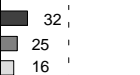

Ap-plica-tion	Features	Appearance	Applicable amplifier unit	Sensing distance (mm) (Values measured using white paper)	Standard object (min. sensing object)	Part number	Permis-sible bend-ing radius
Flexible	Can be bent like electrical wires (R1)	 M6 screw	E3X-DA□-N	 220 170 80	300 × 300 (0.01-mm dia.)	E32-D11R ✂	1 mm
		 M3 screw	E3X-DA□-N	 40 30 10	50 × 50 (0.01-mm dia.)	E32-D21R ✂	
Flexible (resists breaking)	Ideal for mounting on moving sections (R4)	 M6 screw	E3X-DA□-N	 220 170 80	300 × 300 (0.01-mm dia.)	E32-D11 ✂	4 mm
		 M3 screw	E3X-DA□-N	 40 30 10	50 × 50 (0.01-mm dia.)	E32-D21 ✂	
		 M4 screw	E3X-DA□-N	 90 70 25	100 × 100 (0.01-mm dia.)	E32-D21B ✂	
		 1.5-mm dia.	E3X-DA□-N	 40 30 10	50 × 50 (0.01-mm dia.)	E32-D22B	

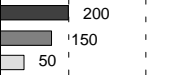
■ SPECIAL-PURPOSE DIFFUSE FIBERS

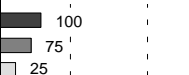
 : Long-distance mode
  : Standard mode
  : High-speed mode

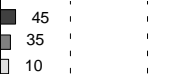
- “Standard object” measurements were made with E3X-DA-N set to Standard mode.
- “Minimum sensing object” is shown in parentheses below the standard object. The values of the minimum sensing object were obtained at a distance where the smallest object (gold wire) can be sensed with the Diffuse Fiber Unit.
- The E3X-DA-N may continue to receive internal reflective light when it is set to the maximum sensitivity setting. In this case, set the amplifier to “two-point teaching with or without-object teaching.”

✂ Indicates models that customers can cut to length for their application. Models without this mark are pre-cut by the factory to maintain their respective specifications.

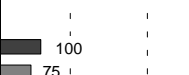



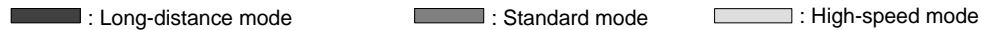

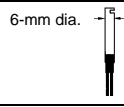
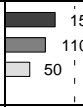

Application	Features	Appearance	Applicable amplifier unit	Sensing distance (mm) (Values measured using white paper)	Standard object (min. sensing object)	Part number	Permissible bending radius
Coaxial	M6 coaxial; high-precision positioning accuracy	 M6 screw	E3X-DA□-N		500 × 500 mm (0.01-mm dia.)	E32-CC200	✂ 25 mm
			E3X-DAB11-N		(0.1-mm dia.)		
	3-mm dia. coaxial; high-precision positioning accuracy	 3-mm dia.	E3X-DA□-N		300 × 300 mm (0.01-mm dia.)	E32-D32L	✂
	M3 coaxial; high-precision positioning accuracy; possible to mount small-spot lens (E39-F3A-5/F3B/F3C)	 M3 screw	E3X-DA□-N		25 × 25 mm (0.01-mm dia.)	E32-C31	✂
	M3 coaxial; high-precision positioning accuracy; possible to mount small-spot lens (E39-F3A-5/F3B/F3C)	 M3 screw	E3X-DA□-N		50 × 50 mm (0.01-mm dia.)	E32-C41	
	2-mm dia. coaxial; high-precision positioning accuracy; possible to mount small-spot (0.1 to 0.6 mm dia.) lens (E39-F3A)	 2-mm dia.	E3X-DA□-N		50 × 50 mm (0.01-mm dia.)	E32-C42	
	2-mm dia. coaxial; high-precision positioning accuracy; possible to mount small-spot (0.5 to 1 mm dia.) lens (E39-F3A)	 2-mm dia.	E3X-DA□-N		100 × 100 mm (0.01-mm dia.)	E32-D32	✂

Special-purpose diffuse fibers – continued from previous page

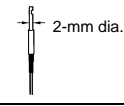
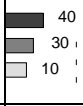

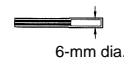

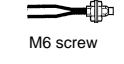
- “Standard object” measurements were made with E3X-DA-N set to Standard mode.
- “Minimum sensing object” is shown in parentheses below the standard object. The values of the minimum sensing object were obtained at a distance where the smallest object (gold wire) can be sensed with the Diffuse Fiber Unit.
- The E3X-DA-N may continue to receive internal reflective light when it is set to the maximum sensitivity setting. In this case, set the amplifier to “two-point teaching with or without-object teaching.”

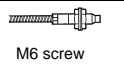
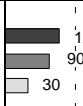
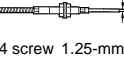
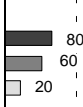
 Indicates models that customers can cut to length for their application. Models without this mark are pre-cut by the factory to maintain their respective specifications.

Application	Features	Appearance	Applicable amplifier unit	Sensing distance (mm) (Values measured using white paper)	Standard object (min. sensing object)	Part number	Permissible bending radius
Side-view	6-mm dia.; long distance		E3X-DA□-N		200 × 200 mm (0.01-mm dia.)	E32-D14L 	25 mm
	2-mm dia.; small diameter space-saving		E3X-DA□-N		50 × 50 mm (0.01-mm dia.)	E32-D24 	
Chemical-resistant	Teflon-covered *1; withstands chemicals and harsh environments; Operating ambient temperature: -30°C to 70°C (-22°F to 158°F)		E3X-DA□-N		200 × 200 mm (0.01-mm dia.)	E32-D12F 	40 mm
Heat-resistant	Resists 150°C *2; fiber sheath material: fluororesin; Operating ambient temperature: -40°C to 150°C (-40°F to 302°F)		E3X-DA□-N		200 × 200 mm (0.01-mm dia.)	E32-D51 	35 mm
	Resists 300°C *3; fiber sheath material: stainless steel; Operating ambient temperature: -40°C to 300°C (-40°F to 572°F)		E3X-DA□-N			E32-D61	25 mm
	Resists 400°C *3; fiber sheath material: stainless steel; Operating ambient temperature: -40°C to 400°C (-40°F to 752°F)		E3X-DA□-N		100 × 100 mm (0.01-mm dia.)	E32-D73	















- Note: 1. Teflon is a registered trademark of the Dupont Company and the Mitsui Dupont Chemical Company for their fluoride resin.
 2. For continuous operation, use the products within the temperature ranging from -40°C to 130°C (-40°F to 266°F).
 3. Indicates the heat-resistant temperature at the fiber tip.

Special-purpose diffuse fibers – continued from previous page

 : Long-distance mode
  : Standard mode
  : High-speed mode

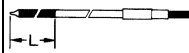

- “Standard object” measurements were made with E3X-DA-N set to Standard mode.
- “Minimum sensing object” is shown in parentheses below the standard object. The values of the minimum sensing object were obtained at a distance where the smallest object (gold wire) can be sensed with the Diffuse Fiber Unit.
- The E3X-DA-N may continue to receive internal reflective light when it is set to the maximum sensitivity setting. In this case, set the amplifier to “two-point teaching with or without-object teaching.”

 Indicates models that customers can cut to length for their application. Models without this mark are pre-cut by the factory to maintain their respective specifications.

Application	Features	Appearance	Applicable amplifier unit	Sensing distance (mm) (Values measured using white paper)	Standard object (min. sensing object)	Part number	Permissible bending radius
Area sensing	Side-view; detection over wide areas		E3X-DA□-N	 200 150 50	300 × 300 mm (0.01-mm dia.)	E32-D36P1 	25 mm
Convergent beam	Suitable for positioning crystal glass		E3X-DA□-N	4 to 12	100 × 100 mm Soda glass with reflection factor of 7%	E32-L56E1 E32-L56E2 	35 mm
	Detects wafers and small differences in height; Operating ambient temperature: -40°C to 105°C (-40°F to 221°F); enclosure rating: IP50		E3X-DA□-N	4±2 4±2 4±2	25 × 25 mm (0.01-mm dia.)	E32-L24L 	10 mm
			E3X-DA□-N	7.2±1.8 7.2±1.8 7.2±1.8		E32-L25L 	
	Detects wafers and small differences in height; enclosure rating: IP50		E3X-DA□-N	3.3 3.3 3.3	25 mm	E32-L25 	25 mm
			E3X-DA□-N	3.3 3.3 3.3		E32-L25A 	
Fluid-level detection	Fluid contact type: unbendable section L 150 mm, 350 mm (two types)		E3X-DA□-N	---	Pure water at 25°C	E32-D82F1 E32-D82F2	40 mm
	Tube-mounting type		E3X-DA□-N	---	Fluid	E32-L25T 	10 mm



■ RETROREFLECTIVE FIBERS

Special-purpose diffuse fibers – continued from previous page

 : Long-distance mode
  : Standard mode
  : High-speed mode

- “Standard object” measurements were made with E3X-DA-N set to Standard mode.
- “Minimum sensing object” is shown in parentheses below the standard object. The values of the minimum sensing object were obtained at a distance where the smallest object (gold wire) can be sensed with the Retroreflective Fiber Unit.
- The E3X-DA-N may continue to receive internal reflective light when it is set to the maximum sensitivity setting. In this case, set the amplifier to “two-point teaching with or without-object teaching.”

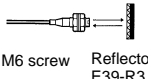
✂ Indicates models that customers can cut to length for their application. Models without this mark are pre-cut by the factory to maintain their respective specifications.

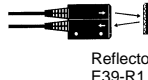
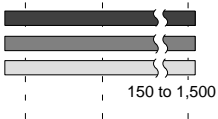
Application	Features	Appearance	Applicable amplifier unit	Sensing distance (mm)	Standard object (min. sensing object)	Part number	Permissible bending radius
Retroreflective	Transparent object detection; compact threaded head is easy to install	 M6 screw Reflector E39-R3	E3X-DA□-N	 10 to 250 10 to 250 10 to 250	35-mm dia. (0.1-mm dia.)	E32-R21 +E39-R3 (supplied)	25 mm
	Detects shiny, transparent and opaque objects; block style sensing head. Operating ambient temperature: -25°C to 55°C; degree of protection: IP66	 Reflector E39-R1	E3X-DA□-N	 150 to 1,500 150 to 1,500 150 to 1,500	35-mm dia. (0.2-mm dia.)	E32-R16 +E39-R1 (supplied)	

NOTE: DIMENSIONS SHOWN ARE IN MILLIMETERS. To convert millimeters to inches divide by 25.4.

OMRON**OMRON ELECTRONICS, INC.**One East Commerce Drive
Schaumburg, IL 60173**1-800-55-OMRON****OMRON CANADA, INC.**885 Milner Avenue
Scarborough, Ontario M1B5V8**416-286-6465**

X-ON Electronics

Largest Supplier of Electrical and Electronic Components

Click to view similar products for [Photoelectric Sensors](#) category:

Click to view products by [Omron](#) manufacturer:

Other Similar products are found below :

[7442AD2X5FRX](#) [EX-19B-LP](#) [EX-19SB-PN](#) [7443AR0X5FRX](#) [7452AD4D4NNX](#) [F3WD052C5M](#) [7655AR-04-F-1-2-RX](#) [7694ADE04DS2X](#)
[FE7C-FRC6S-M](#) [FX-305](#) [PM-R24-R](#) [Q45VR2FPQ](#) [13104RQD07](#) [E3JUXM4MN](#) [E3L2DC4](#) [E3S3LE21](#) [E3SCT11M1J03M](#) [E3SDS20E21](#)
[E3VDS70C43S](#) [E3XNM16](#) [BR23P](#) [HOA6563-001](#) [OJ-3307-30N8](#) [OS-311A-30](#) [P32013](#) [P34036](#) [P43004](#) [P56001](#) [P60001](#) [PB10CNT15PO](#)
[S14132](#) [935286-000](#) [S52101](#) [S56258](#) [SH-21E](#) [EX-L261-P](#) [FD-SN500](#) [FE7B-FDRB6-M](#) [SU-79](#) [T36342](#) [T40300](#) [T60001](#) [PD60CNX20BP](#)
[FX-302-HY](#) [FZS](#) [PM-T64W](#) [PX-22](#) [PZ2-51P](#) [CX-491-P-J](#) [CYNUTX10](#)