

Fiber Sensor Best Selection Catalog

Find the best fiber sensor for your application.



E32 Series Fiber Units



Advanced Functionality
Fiber Amplifiers

E3NX-FA



General Purpose Fiber
Amplifiers

E3X-HD



Best Selection

Fiber Sensor Best Selection Catalog



Start with Smart!
Easily select the most reliable Fiber Unit
for your detection conditions.



E32 Series Fiber Units

Advanced Functionality
Fiber Amplifiers
E3NX-FA

General Purpose
Fiber Amplifiers
E3X-HD



Fiber Sensor Features	2 Page
Selection Guide	4 Page
Fiber Units	
Standard Installation	6 Page
Saving Space	14 Page
Beam Improvements	20 Page
Transparent Objects	34 Page
Environmental Immunity	38 Page
Applications	48 Page
Installation Information	58 Page
Fiber Amplifiers, Communications Unit, and Accessories	62 Page
Technical Guide and Precautions	90 Page
Model Index	98 Page

Easy

“Mounts Anywhere”

Wide Variety

Variouly-shaped, compact heads allow installation in any small space.

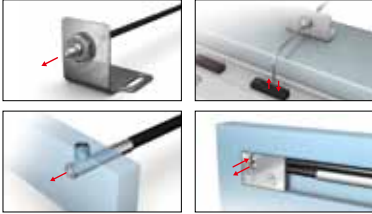

Suitable for Harsh Environments

Fiber Units are available for various installation conditions and can be installed as is, even in harsh environments.

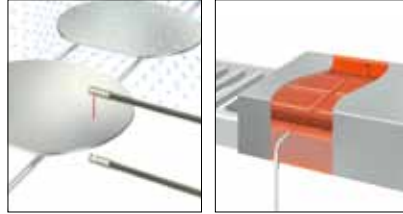

“Achieve Easy Detection in Many Applications”

Smart Tuning

Just press the button to set the optimum incident level and threshold. Consistent settings are achieved for all users with this ultra-easy procedure.



Automatic Setting of Optimum Values

Threshold + Incident Level

5000 9999

Set to the intermediate value between the incident levels with and without a workpiece. Incident level adjustment with and without a workpiece.

Dynamic Range Increased by a Factor of 40,000

The incident level is optimized to enable stable detection even for saturated or insufficient incident levels.

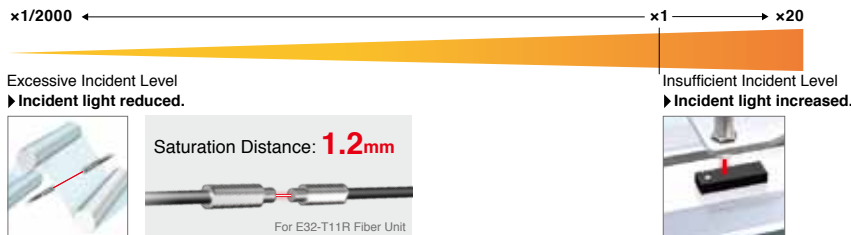

Smart Fiber Amplifier Units E3NX-FA

Page
62, 64

“Smooth Wiring and Setting”

Reduced Wiring

Simply link the Fiber Amplifier Units together for easy wiring and digital display comparison.

Separate Installation

Use the Distributed Sensor Unit for distributed installation to reduce costs and work.

Easy Setup

Calibration time is reduced with batch setting from a Touch Panel or backup data for process switchovers.

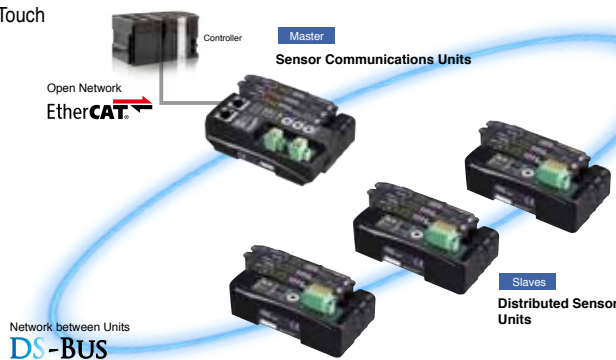

Fiber

‘Easy’ and ‘Stable’ for

Stable

Fiber Units E32

Page
06



“Expanded Application Capabilities”

Improved Basic Performance

Improvements in sensing distance and minimum sensing object increase the range of application for stable detection.

1.5 Times
the Sensing Distance*

6 m

For E32-LT11 Fiber Unit with a fiber length of 3.5 m

1/10th
the Minimum Sensing Object*

0.3 μm dia.

Typical example of actual measurements with E32-D11R Fiber Unit.

*Compared to E3X-HD.

Sensor Communications Units E3NW

EtherCAT

Page
62, 64

Sensor

Minimal Cost Process.

Basic Features of Fiber Sensors

Ideal for narrow spaces or for detecting minute objects.



Digital display achieves visual control and quantitative control.

Conventional Photoelectric Sensor with Built-in Amplifier

Set the threshold by a sensitivity adjuster / Check the operation by an indicator.



- Ambiguous standard (e.g., 3/4 turn of adjuster)
- Indicator does not show the present value.

Fiber Sensor

Quantitative control over threshold settings with a digital display.



- The reference value can be set numerically for easier specification.
- Easily perceivable present value.

Selection by Category

STEP 1

Select a Fiber Unit.

Select a category.

[Fiber Unit Index](#)

Page
05

Select a model.

[Category Pages](#)

Page
06 to 61

STEP 2

Select a Fiber Amplifier Unit and Communications Unit.

Page
62

STEP 3

Select Accessories of Fiber Amplifier Unit

Page
65,79

Before Selecting Fiber Units

The Fiber Units specifications give the sensing distance when the Fiber Unit and Fiber Amplifier Unit is combined. Check the Fiber Amplifier Unit series for easier selection.

<Specifications on Each Fiber Unit Category Page>

Series	Sensing distance (mm)
E3X-HD	2,000
E3NX-FA	3,000

Fiber Amplifier Unit Series

		E3X-HD Series	E3NX-FA Series	
Fiber Amplifier Unit specifications	Output	1 output	1 or 2 outputs (depending on the model)	
	External input	not supported	Supported or not supported (depending on the model)	
	Response time	50 μ s (55 μ s)/250 μ s/1 ms/16 ms (Default: 250 μ s)	30 μ s (32 μ s)/250 μ s/1 ms/16 ms (Default: 250 μ s)	
	Sensing distance (Giga-power mode)	E32-T11R	2,000 mm	3,000 mm
		E32-D11R	840 mm	1,260 mm
Minimum sensing object	E32-T11R	5 μ m dia.	2 μ m dia.	
Sensor Communications Unit application	Communications method (Sensor Communications Unit model)	EtherCAT (E3X-ECT) CompoNet (E3X-CRT)	EtherCAT (E3NW-ECT) CompoNet (E3NW-CRT) CC-Link (E3NW-CCL)	
	Applicable Sensors	Fiber Sensor (E3X-HD0) Fiber Sensor (E3X-DA0-S, E3X-MDA0) Laser Photoelectric Sensor (E3C-LDA0) Proximity Sensor (E2C-EDA0)	Fiber Sensor (E3NX-FA0) Laser Sensors (E3NC-LA0, E3NC-SA0)	
Page listings	Ordering Information	Page 78	Page 64	
	Ratings and Specifications	Page 80	Page 66	
	Dimensions	Page 80	Page 68	

Selection by Model

STEP 1





Search for the page in the model index.



Page
98



STEP 2

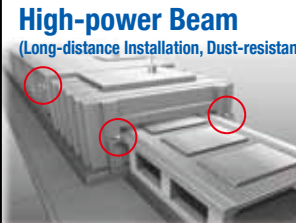

Search for the model on the corresponding pages.



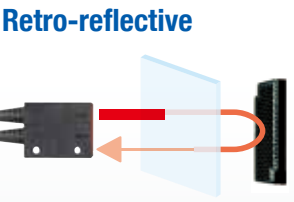

Each
Page

Standard Installation		Saving Space	
<p>Threaded Models</p>  <p>Standard screw-type installation. The Fiber Units is mounted into a drilled hole and secured with nuts. Page 06</p>	<p>Cylindrical Models</p>  <p>Ideal for installation in narrow spaces. The Fiber Unit is secured with a set screw. Page 10</p>	<p>Flat Models</p>  <p>Mount directly in limited spaces without using special mounting brackets. Page 14</p>	<p>Sleeve Models (Close-range Detection)</p>  <p>Suitable for close-range detection. Ideal for detecting minute objects in areas with limited space. Page 16</p>

Beam Improvements			
<p>Small-Spot, Reflective (Minute Object Detection)</p>  <p>Small-spot to accurately detect small objects. Page 20</p>	<p>High-power Beam (Long-distance Installation, Dust-resistant)</p>  <p>Suitable for detection on large equipment, of large objects, and in environments with airborne particles. Page 24</p>	<p>Narrow View (Detection Across Clearance)</p>  <p>The Fiber Unit emits a non-spreading beam to prevent false detection of light reflected off surrounding objects. Page 30</p>	<p>Detection without Background Interference</p>  <p>Detect only objects in the sensing range, and not in the background. Page 32</p>

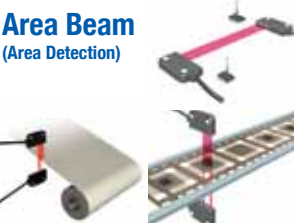
Transparent Object Detection	
<p>Retro-reflective</p>  <p>Detect transparent objects reliably because the beam passes through the object twice, resulting in greater light interruption. Page 34</p>	<p>Limited-reflective (Glass Detection)</p>  <p>The limited-reflective optical system provides stable detection of specular reflective glass. Page 36</p>

Environmental Immunity		
<p>Chemical-resistant, Oil-resistant</p>  <p>Made from materials that are resistant to various oils and chemicals. Page 38</p>	<p>Bending-resistant, Disconnection-resistant</p>  <p>Resistant to repeated bending on moving parts and breaking from snagging or shock. Page 40</p>	<p>Heat-resistant</p>  <p>Can be used in high-temperature environments at up to 400°C. Page 44</p>

Special Applications			
<p>Area Beam (Area Detection)</p>  <p>Detect across areas for meandering materials or falling workpieces whose positions vary. Page 48</p>	<p>Liquid-level Detection</p>  <p>Detect liquid level when being mounted on tubes or in liquid. Page 50</p>	<p>Vacuum-resistant</p>  <p>Can be used under high vacuums of up to 10⁻⁵ Pa. Page 52</p>	<p>FPD, Semiconductors, and Solar Cells</p>  <p>Designed specifically to reliably detect glass substrates and wafers. Page 54</p>

Fiber Sensing Features	
Selection Guide	
Fiber Units	
Threaded	Standard Installation
Cylindrical	Standard Installation
Flat	Saving Space
Sleeved	Saving Space
Small Spot	Beam Improvements
High Power	Beam Improvements
Narrow view	Beam Improvements
BGS	Beam Improvements
Retro-reflective	Transparent Objects
Limited-reflective	Transparent Objects
Chemical-resistant, Oil-resistant	Environmental Immunity
Bending	Environmental Immunity
Heat-resistant	Environmental Immunity
Area Detection	Applications
Liquid-level	Applications
Vacuum	Applications
FPD, Semi, Solar	Applications
Installation Information	
Fiber Amplifiers, Communications Unit, and Accessories	
Technical Guide and Precautions	
Model Index	

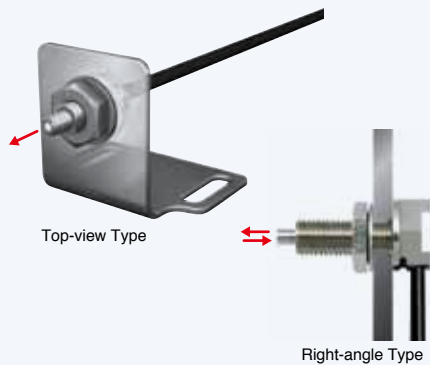

- Standard configuration. These Fiber Units are mounted into a hole drilled in a bracket and secured with nuts.
- The Right-angle Model prevents snagging on the cable because the cable runs along the mounting surface.

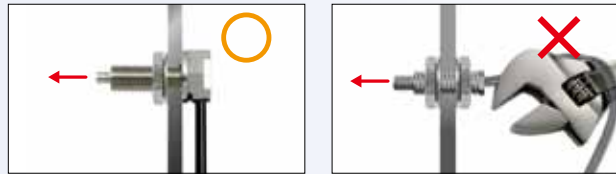

Specifications

Through-beam Fiber Units

Sensing direction (Aperture angle)	Size	Appearance (mm)	Bending radius of cable (mm)	Sensing distance (mm)				Optical axis diameter (minimum sensing object)	Models	Page 07 Dimensions No.
				E3X-HD		E3NX-FA				
				GIGA	HS	GIGA	HS			
Right-angle (Approx. 60°)	M4		Flexible**, R1	2,000	ST : 1,000	3,000	ST : 1,500	1 dia. (5 μm dia./ 2 μm dia.)	E32-T11N 2M	07-A
				700	SHS : 280	1,050	SHS : 280			
Top-view (Approx. 60°)	M4		R25	4,000*	ST : 4,000*	4,000*	ST : 4,000*	2.3 dia. (0.1 dia./ 0.03 dia.)	E32-LT11 2M	07-C
Top-view (Approx. 15°)	M4			2,700	SHS : 1,080	4,000*	SHS : 1,080			
			Flexible**, R1	4,000*	ST : 3,500	4,000*	ST : 4,000*			
				2,300	SHS : 920	3,450	SHS : 920			

* The optical fiber is 2 m long on each side, so the sensing distance is 4,000 mm.

** For a definition, see page 90.

Note 1. The following mode names and response times apply to the modes given in the Sensing distance column.

[E3X-HD] GIGA: Giga-power mode (16 ms), HS: High-speed mode (250 μs), ST: Standard mode (1 ms), and SHS: Super-high-speed mode (NPN output: 50 μs, PNP output: 55 μs)
[E3NX-FA] GIGA: Giga-power mode (16 ms), HS: High-speed mode (250 μs), ST: Standard mode (1 ms), and SHS: Super-high-speed mode (30 μs)

2. The values for the minimum sensing object are reference values that indicate values obtained in standard mode with the sensing distance and sensitivity set to the optimum values. The first value is for the E3X-HD and the second value is for the E3NX-FA.

Through-beam Fiber Units (Set of 2)

07-A E32-T11N 2M (Free Cutting)

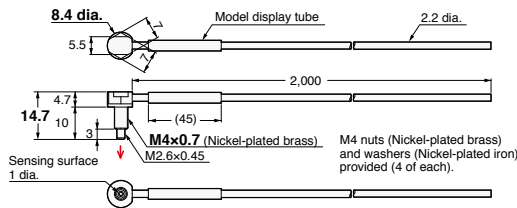

07-B E32-T11R 2M (Free Cutting)

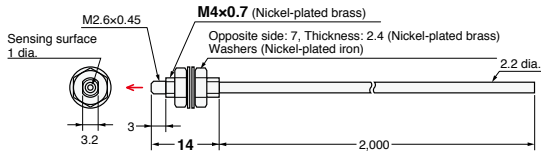

07-C E32-LT11 2M (Free Cutting)
E32-LT11R 2M (Free Cutting)

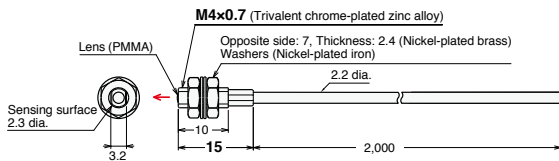

- Reference Information for Model Selection -

Features of the Right-angle Type

- Cable is less prone to snagging.
- Cable runs along the mounting surface for less space compared with Top-view Fiber Units.
- The nut is attached to the Fiber Unit to reduce installation work.

What Is “Flexible” Fiber?

The flexible fiber has a small bending radius for easy routing without fiber damage. It improves sensor performance because the cable can be bent without significantly reducing light intensity.

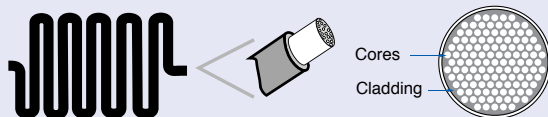

The core consists of a large number of ultrafine fibers surrounded by cladding.

And

Long-distance Sensing Applications

A separate Lens Unit can be attached to extend the sensing distance.
→ Page 26

Breaking Due to Snagging or Shock

The Fiber Unit can be protected from breaking with a stainless steel spiral tube.
→ Page 40 (Excluding the E32-T11N 2M.)

Threaded

Cylindrical

Flat

Sleeved

Small Spot

High Power

Narrow view

BGS

Retro-reflective

Limited-reflective

Chemical-resistant, Oil-resistant

Bending

Heat-resistant

Area Detection

Liquid-level

Vacuum

FPD, Semi, Solar

Installation Information

Fiber Amplifiers, Communications Unit, and Accessories

Technical Guide and Precautions

Model Index

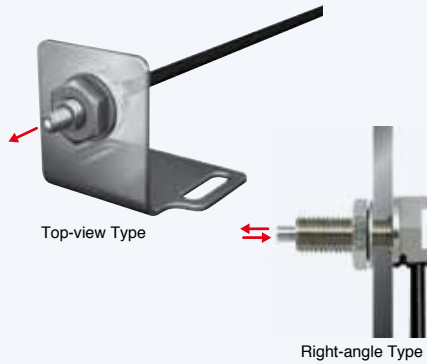

- Standard configuration. These Fiber Units are mounted into a hole drilled in a bracket and secured with nuts.
- The Right-angle Model prevents snagging on the cable because the cable runs along the mounting surface.

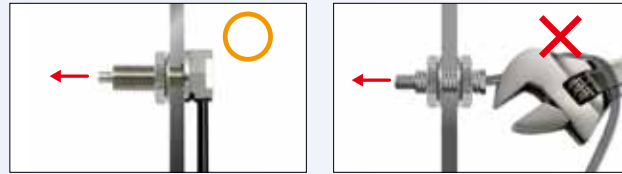

Specifications

Reflective Fiber Units

Sensing direction (Aperture angle)	Size	Appearance (mm)	Bending radius of cable (mm)	Sensing distance (mm)				Optical axis diameter (minimum sensing object)	Models	Page 09 Dimensions No.
				E3X-HD		E3NX-FA				
				GIGA	HS	Other modes	GIGA			
Right-angle (Approx. 60°)	M3		Flexible*, R4	110	ST : 50	160	ST : 75	(5 μm dia./ 2 μm dia.)	E32-C31N 2M	09-A
	M6			46	SHS: 14	69	SHS: 14			
Top-view (Approx. 60°)	M3		Flexible*, R1	140	ST : 60	210	ST : 90		E32-D21R 2M	09-C
				40	SHS: 16	60	SHS: 16		E32-C31 2M	09-D
				100	SHS: 44	150	SHS: 44		E32-C31M 1M	09-E
	M4	Flexible*, R1		140	ST : 60	210	ST : 90		E32-D211R 2M	09-F
				40	SHS: 16	60	SHS: 16			
				840	ST : 350	1,260	ST : 520			
M6	Flexible*, R1		240	SHS: 100	360	SHS: 100	E32-D11R 2M		09-G	
			1,400	ST : 600	2,100	ST : 900	E32-CC200 2M	09-H		
Top-view (Approx. 15°)	M6		R25	860	ST : 360	1,290	ST : 540	(1 dia./ 0.03 dia.)	E32-LD11 2M	09-I
				250	SHS: 110	370	SHS: 110			
			Flexible*, R1	840	ST : 350	1,260	ST : 520	E32-LD11R 2M		
			R1	240	SHS: 100	360	SHS: 100			

* For a definition, see page 90.

Note 1. The following mode names and response times apply to the modes given in the Sensing distance column.

[E3X-HD] GIGA: Giga-power mode (16 ms), HS: High-speed mode (250 μs), ST: Standard mode (1 ms), and SHS: Super-high-speed mode (NPN output: 50 μs, PNP output: 55 μs)
 [E3NX-FA] GIGA: Giga-power mode (16 ms), HS: High-speed mode (250 μs), ST: Standard mode (1 ms), and SHS: Super-high-speed mode (30 μs)

2. The values for the minimum sensing object are reference values that indicate values obtained in standard mode with the sensing distance and sensitivity set to the optimum values.

The first value is for the E3X-HD and the second value is for the E3NX-FA.

3. The sensing distances for Reflective Fiber Units are for white paper.

Reflective Fiber Units

09-A E32-C31N 2M (Free Cutting)

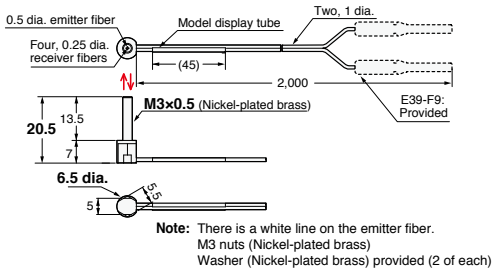

09-B E32-C11N 2M (Free Cutting)

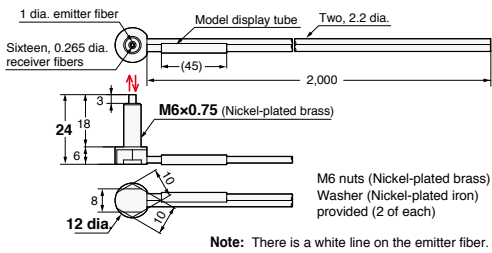

09-C E32-D21R 2M (Free Cutting)

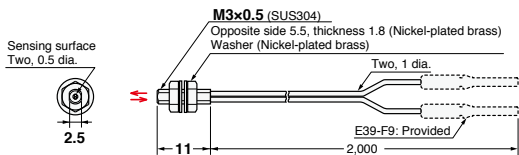

09-D E32-C31 2M (Free Cutting)

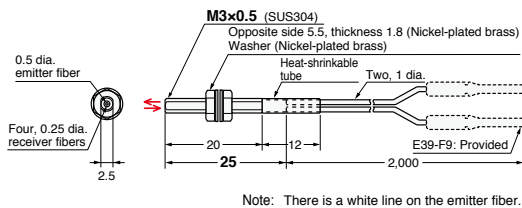

09-E E32-C31M 1M (Free Cutting)

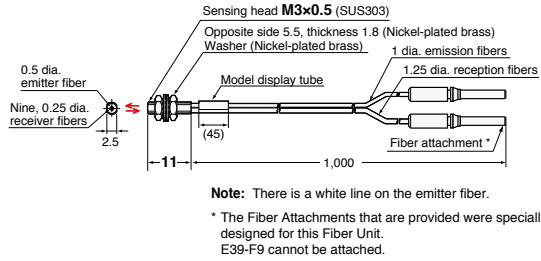

09-F E32-D211R 2M (Free Cutting)

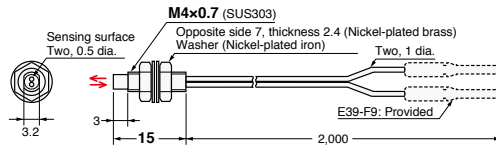

09-G E32-D11R 2M (Free Cutting)

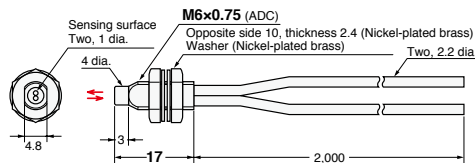

09-H E32-CC200 2M (Free Cutting)

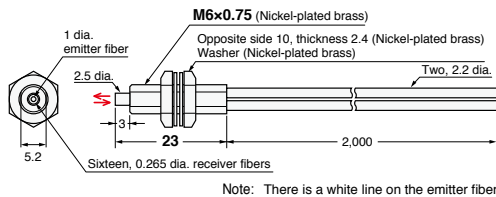

09-I E32-LD11 2M (Free Cutting) E32-LD11R 2M (Free Cutting)

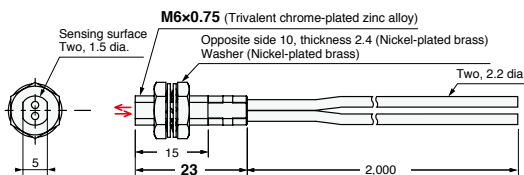

- Reference Information for Model Selection -

Features of Coaxial Reflective Type

These Fiber Units offer better detection of small objects at close distances (of 2 mm or less) than Standard Reflective Fiber Units. They also detect glossy surfaces more reliably than Standard Reflective Fiber Units, even if the surface is tilted. The receiver fibers are arranged around the emitter fiber as shown below.

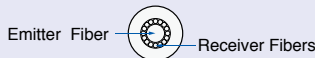

Features of the Right-angle Type

- Cable is less prone to snagging.
- Cable runs along the mounting surface for less space compared with Top-view Fiber Units.
- The nut is attached to the Fiber Unit to reduce installation work.

What Is "Flexible" Fiber?

The flexible fiber has a small bending radius for easy routing without fiber damage. It improves sensor performance because the cable can be bent without significantly reducing light intensity.

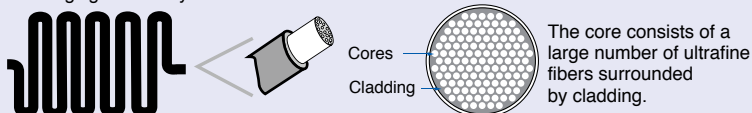

And

Breaking Due to Snagging or Shock

The Fiber Unit can be protected from breaking with a stainless steel spiral tube. → Page 42

Fiber Sensing Features	
Selection Guide	
Fiber Units	
Threaded	Standard Installation
Cylindrical	
Flat	Saving Space
Sleeved	
Small Spot	Beam Improvements
High Power	
Narrow view	
BGS	
Retro-reflective	Transparent Objects
Limited-reflective	
Chemical-resistant, Oil-resistant	Environmental Immunity
Bending	
Heat-resistant	
Area Detection	Applications
Liquid-level	
Vacuum	
FPD, Semi, Solar	
Installation Information	
Fiber Amplifiers, Communications Unit, and Accessories	
Technical Guide and Precautions	
Model Index	

Threaded

Cylindrical

Flat

Sleeved

Small Spot

High Power

Narrow view

BGS

Retro-reflective

Limited-reflective

Chemical-resistant, Oil-resistant

Bending

Heat-resistant

Area Detection

Liquid-level

Vacuum

FPD, Semi, Solar

- Used where space is limited. (Secured using a set screw.)
- Extreme space-saving with the micro-fiber head. (1 dia. x 10 mm)

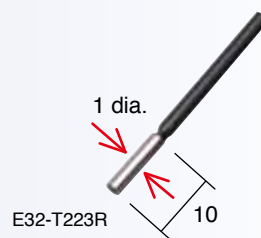
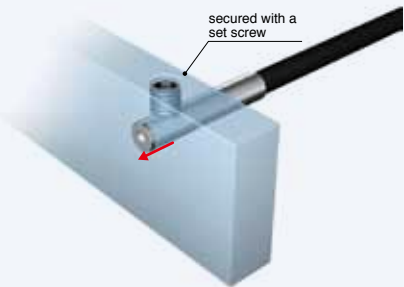

Specifications

Through-beam Fiber Units

Size	Sensing direction	Appearance (mm)	Bending radius of cable (mm)	Sensing distance (mm)						Optical axis diameter (minimum sensing object)	Models	Page 11 Dimensions No.
				E3X-HD			E3NX-FA					
				GIGA	HS	Other modes	GIGA	HS	Other modes			
1 dia.	Top-view		Flexible**, R1	450	ST : 250	670	ST : 370	0.5 dia. (5 μm dia./ 2 μm dia.)	E32-T223R 2M	11-A		
				150	SHS: 60	220	SHS: 60					
1.5 dia.	Top-view		Bend-resistant*, R4	680	ST : 400	1,020	ST : 600	1 dia. (5 μm dia./ 2 μm dia.)	E32-T22B 2M	11-B		
				220	SHS: 90	330	SHS: 90					
3 dia.	Side-view		Flexible**, R1	2,000	ST : 1,000	3,000	ST : 1,500	1 dia. (5 μm dia./ 2 μm dia.)	E32-T12R 2M	11-C		
				700	SHS: 280	1,050	SHS: 280					
3 dia.	Side-view		Flexible**, R1	750	ST : 450	1,120	ST : 670	1 dia. (5 μm dia./ 2 μm dia.)	E32-T14LR 2M	11-D		
				260	SHS: 100	390	SHS: 100					

* Bend-resistant fibers are for repeated bending applications, whereas Flexible fibers are meant for routing around tight corners.

** For a definition, see page 90.

Note 1. The following mode names and response times apply to the modes given in the Sensing distance column.

[E3X-HD] GIGA: Giga-power mode (16 ms), HS: High-speed mode (250 μs), ST: Standard mode (1 ms), and SHS: Super-high-speed mode (NPN output: 50 μs, PNP output: 55 μs)
 [E3NX-FA] GIGA: Giga-power mode (16 ms), HS: High-speed mode (250 μs), ST: Standard mode (1 ms), and SHS: Super-high-speed mode (30 μs)

2. The values for the minimum sensing object are reference values that indicate values obtained in standard mode with the sensing distance and sensitivity set to the optimum values. The first value is for the E3X-HD and the second value is for the E3NX-FA.

Through-beam Fiber Units (Set of 2)

11-A E32-T223R 2M (Free Cutting)

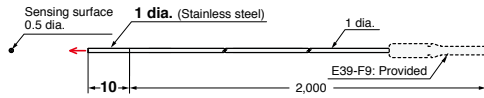

11-B E32-T22B 2M (Free Cutting)

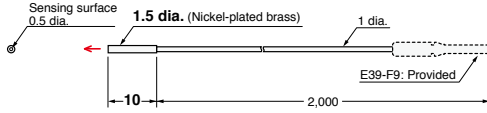

11-C E32-T12R 2M (Free Cutting)

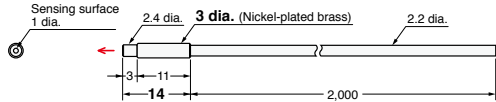

11-D E32-T14LR 2M (Free Cutting)

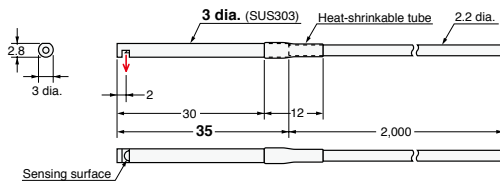

- Reference Information for Model Selection -

Recommended Mounting Hole Dimensions

The recommended mounting-hole dimensions for Cylindrical Fiber Units are given below.

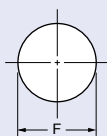

(Unit: mm)

Outer diameter of Fiber Unit	1 dia.	1.5 dia.	3 dia.
Dimension F	1.2 ^{+0.5} ₀ dia.	1.7 ^{+0.5} ₀ dia.	3.2 ^{+0.5} ₀ dia.

Threaded

Cylindrical

Standard Installation

Flat

Saving Space

Sleeved

Small Spot

High Power

Beam Improvements

Narrow view

BGS

Retro-reflective

Limited-reflective

Transparent Objects

Chemical-resistant, Oil-resistant

Environmental Immunity

Bending

Heat-resistant

Area Detection

Liquid-level

Applications

Vacuum

FPD, Semi, Solar

Installation Information

Fiber Amplifiers, Communications Unit, and Accessories

Technical Guide and Precautions

Model Index

Threaded

Cylindrical

Flat

Sleeved

Small Spot

High Power

Narrow view

BGS

Retro-reflective

Limited-reflective

Chemical-resistant,
Oil-resistant

Bending

Heat-resistant

Area
Detection

Liquid-level

Vacuum

- Inserted where space is limited.
(Secured using a set screw.)

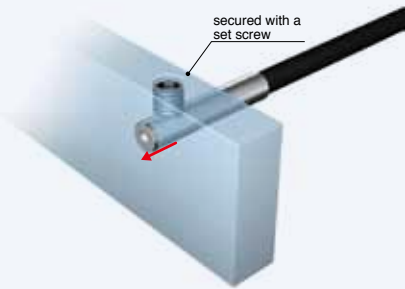

Specifications

Reflective Fiber Units

Size	Sensing direction	Appearance (mm)	Bending radius of cable (mm)	Sensing distance (mm)						Optical axis diameter (minimum sensing object)	Models	Page 13 Dimensions No.
				E3X-HD			E3NX-FA					
				GIGA	HS	Other modes	GIGA	HS	Other modes			
1.5 dia.	Top-view		Bend-resistant**, R4	140	ST : 60	210	ST : 90	(5 μm dia./ 2 μm dia.)	E32-D22B 2M	13-A		
1.5 dia. + 0.5 dia.			R4	28	ST : 12	42	ST : 18				E32-D43M 1M	13-B
3 dia.			Flexible*, R1	140	ST : 60	210	ST : 90				E32-D22R 2M	13-C
			Bend-resistant**, R4	300	ST : 140	450	ST : 210				E32-D221B 2M	13-D
			R25	700	ST : 300	1,050	ST : 450				E32-D32L 2M	13-E
3 dia. + 0.8 dia.			R4	70	ST : 30	100	ST : 45				E32-D33 2M	13-F

* For a definition, see page 90.

** Bend-resistant fibers are for repeated bending applications, whereas Flexible fibers are meant for routing around tight corners.

Note 1. The following mode names and response times apply to the modes given in the Sensing distance column.

[E3X-HD] GIGA: Giga-power mode (16 ms), HS: High-speed mode (250 μs), ST: Standard mode (1 ms), and SHS: Super-high-speed mode (NPN output: 50 μs, PNP output: 55 μs)

[E3NX-FA] GIGA: Giga-power mode (16 ms), HS: High-speed mode (250 μs), ST: Standard mode (1 ms), and SHS: Super-high-speed mode (30 μs)

2. The values for the minimum sensing object are reference values that indicate values obtained in standard mode with the sensing distance and sensitivity set to the optimum values.

The first value is for the E3X-HD and the second value is for the E3NX-FA.

3. The sensing distances for Reflective Fiber Units are for white paper.

Reflective Fiber Units

13-A E32-D22B 2M (No Cutting)

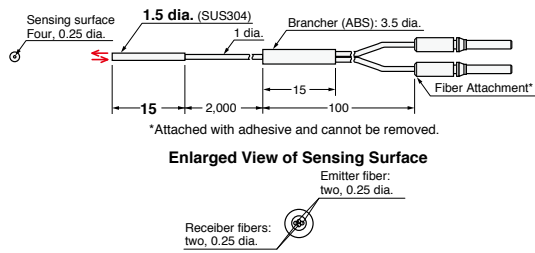

13-B E32-D43M 1M (No Cutting)

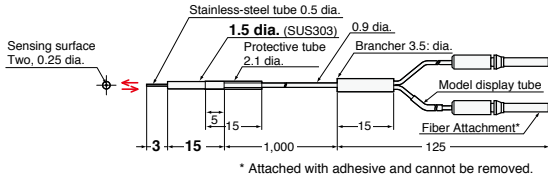

13-C E32-D22R 2M (Free Cutting)

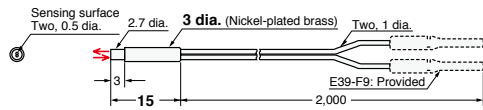

13-D E32-D221B 2M (Free Cutting)

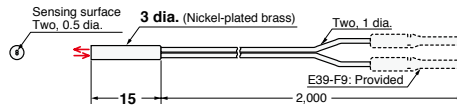

13-E E32-D32L 2M (Free Cutting)

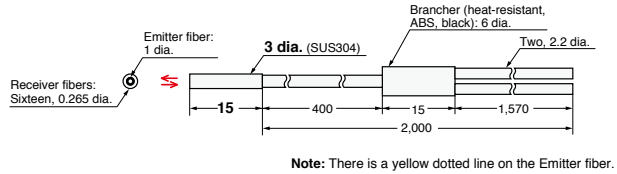

13-F E32-D33 2M (Free Cutting)

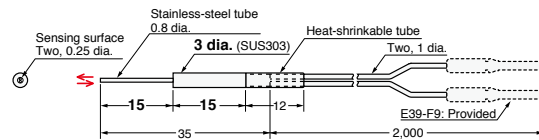

- Reference Information for Model Selection -

Features of Coaxial Reflective Type

These Fiber Units offer better detection of small objects at close distances (of 2 mm or less) than Standard Reflective Fiber Units. They also detect glossy surfaces more reliably than Standard Reflective Fiber Units, even if the surface is tilted. The receiver fibers are arranged around the emitter fiber as shown below.



Recommended Mounting Hole Dimensions

The recommended mounting-hole dimensions for Cylindrical Fiber Units are given below.

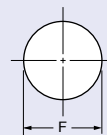

(Unit: mm)

Outer diameter of Fiber Unit	1.5 dia.	3 dia.
Dimension F	1.7 ^{+0.5} ₀ dia.	3.2 ^{+0.5} ₀ dia.

Fiber Sensors Features

Selection Guide

Fiber Units

Threaded

Cylindrical

Flat

Sleeved

Small Spot

High Power

Narrow view

BGS

Retro-reflective

Limited-reflective

Chemical-resistant, Oil-resistant

Bending

Heat-resistant

Area Detection

Liquid-level

Vacuum

FPD, Semi, Solar

Installation Information

Fiber Amplifiers, Communications Unit, and Accessories

Technical Guide and Precautions

Model Index

Threaded

Cylindrical

Flat

Sleeved

Small Spot

High Power

Narrow view

BGS

Retro-reflective

Limited-reflective

Chemical-resistant,
Oil-resistant

Bending

Heat-resistant

Area Detection

Liquid-level

Vacuum

FPD,
Semi,
Solar

Flat-View Type

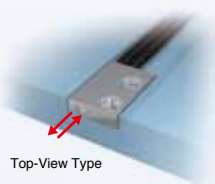

Top-View Type





Side-View Type

- Thin profile for mounting in limited spaces.
- Mounts directly without using special mounting brackets.

Specifications

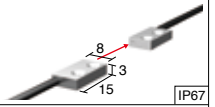
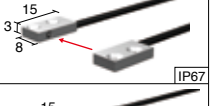
Through-beam Fiber Units

Sensing direction	Appearance (mm)	Bending radius of cable (mm)	Sensing distance (mm)				Optical axis diameter (minimum sensing object)	Models	Page 15 Dimensions No.
			E3X-HD		E3NX-FA				
			GIGA	HS	GIGA	HS			
Top-view		Flexible*, R1	2,000	Other modes	3,000	Other modes	1 dia. (5 μm dia./ 2 μm dia.)	E32-T15XR 2M	15-A
	700		ST : 1,000	1,050	ST : 1,500	SHS : 280			
						SHS : 280			
Side-view			750	ST : 450	1,120	ST : 670	E32-T15YR 2M	15-B	
Flat-view			260	SHS : 100	390	SHS : 100	E32-T15ZR 2M	15-C	

Reflective Fiber Units

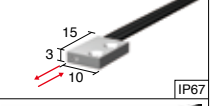
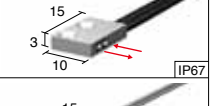
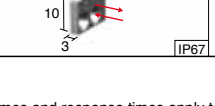
Sensing direction	Appearance (mm)	Bending radius of cable (mm)	Sensing distance (mm)				Optical axis diameter (minimum sensing object)	Models	Page 15 Dimensions No.
			E3X-HD		E3NX-FA				
			GIGA	HS	GIGA	HS			
Top-view		Flexible*, R1	840	Other modes	1,260	Other modes	(5 μm dia./ 2 μm dia.)	E32-D15XR 2M	15-D
	240		ST : 350	360	ST : 520	SHS : 100			
						SHS : 100			
Side-view			200	ST : 100	300	ST : 150	E32-D15YR 2M	15-E	
Flat-view			52	SHS : 24	78	SHS : 24	E32-D15ZR 2M	15-F	

* For a definition, see page 90.

Note 1. The following mode names and response times apply to the modes given in the Sensing distance column.

[E3X-HD] GIGA: Giga-power mode (16 ms), HS: High-speed mode (250 μs), ST: Standard mode (1 ms), and SHS: Super-high-speed mode (NPN output: 50 μs, PNP output: 55 μs)
[E3NX-FA] GIGA: Giga-power mode (16 ms), HS: High-speed mode (250 μs), ST: Standard mode (1 ms), and SHS: Super-high-speed mode (30 μs)

2. The values for the minimum sensing object are reference values that indicate values obtained in standard mode with the sensing distance and sensitivity set to the optimum values.

The first value is for the E3X-HD and the second value is for the E3NX-FA.

3. The sensing distances for Reflective Fiber Units are for white paper.



Through-beam Fiber Units (Set of 2)

15-A E32-T15XR 2M (Free Cutting)

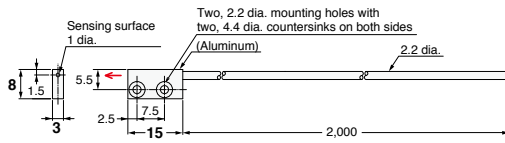

Note: 1. Set of two symmetrically shaped Fiber Units.
2. Four, M2 x 8 stainless steel countersunk mounting screws are provided.

15-B E32-T15YR 2M (Free Cutting)

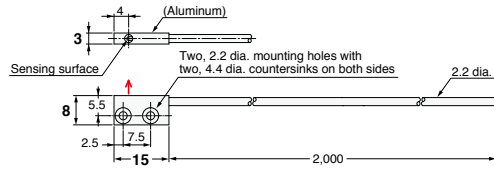

Note: 1. Set of two symmetrically shaped Fiber Units.
2. Four, M2 x 8 stainless steel countersunk mounting screws are provided.

15-C E32-T15ZR 2M (Free Cutting)

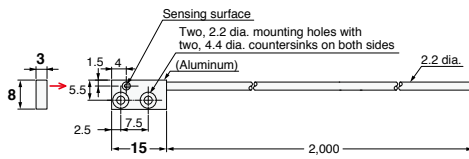

Note: 1. Set of two symmetrically shaped Fiber Units.
2. Four, M2 x 8 stainless steel countersunk mounting screws are provided.



Reflective Fiber Units

15-D E32-D15XR 2M (Free Cutting)

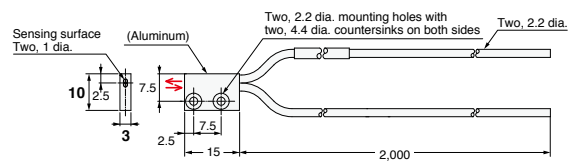

Note: Two, M2 x 8 stainless steel countersunk mounting screws are provided.

15-E E32-D15YR 2M (Free Cutting)

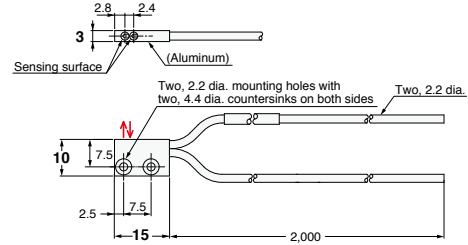

Note: Two, M2 x 8 stainless steel countersunk mounting screws are provided.

15-F E32-D15ZR 2M (Free Cutting)

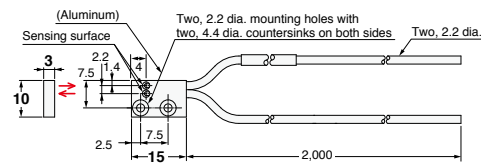

Note: Two, M2 x 8 stainless steel countersunk mounting screws are provided.

Threaded

Cylindrical

Flat

Sleeved

Small Spot

High Power

Narrow view

BGS

Retro-reflective

Limited-reflective

Chemical-resistant, Oil-resistant

Bending

Heat-resistant

Area Detection

Liquid-level

Vacuum

FPD, Semi, Solar

Standard Installation

Saving Space

Beam Improvements

Transparent Objects

Environmental Immunity

Applications

Installation Information

Fiber Amplifiers, Communications Unit, and Accessories

Technical Guide and Precautions

Model Index

Threaded

Cylindrical

Flat

Sleeved

Small Spot

High Power

Narrow view

BGS

Retro-reflective

Limited-reflective

Chemical-resistant,
Oil-resistant

Bending

Area
Detection

Liquid-level

Vacuum

FPD,
Semi,
Solar

- Sleeve Fiber Units allow detection away from the point of installation for stable close-range detection of small objects.
- Some Sleeve models can be bent a single time.

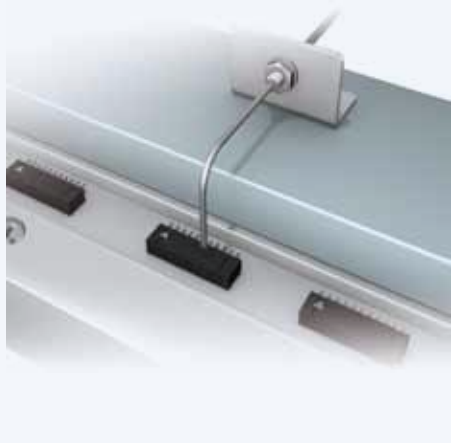
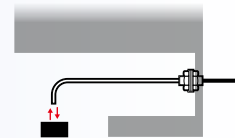

Specifications

Through-beam Fiber Units

Sensing direction	Appearance (mm)	Bending radius of cable (mm)	Sensing distance (mm)				Optical axis diameter (minimum sensing object)	Models	Page 17 Dimensions No.	
			E3X-HD		E3NX-FA					
			GIGA	HS	GIGA	HS				
Side-view	The sleeve cannot be bent. 	Flexible*, R1	170	ST : 100	250	ST : 150	0.5 dia. (5 μm dia./ 2 μm dia.)	E32-T24R 2M	17-A	
			50	SHS: 20	75	SHS: 20		E32-T24E 2M	17-B	
Top-view	The sleeve cannot be bent. 	R10	450	ST : 250	670	ST : 370		0.25 dia. (5 μm dia./ 2 μm dia.)	E32-T33 1M	17-C
			150	SHS: 60	220	SHS: 60				
	The sleeve cannot be bent. 		150	ST : 90	220	ST : 130				
			50	SHS: 20	75	SHS: 20				
	The sleeve cannot be bent. 		510	ST : 300	760	ST : 450	0.5 dia. (5 μm dia./ 2 μm dia.)	E32-T21-S1 2M	17-D	
		170	SHS: 68	250	SHS: 68					
	Sleeve bending radius: 5 mm 	Flexible*, R1	2,000	ST : 1,000	3,000	ST : 1,500	1 dia. (5 μm dia./ 2 μm dia.)	E32-TC200BR 2M	17-E	
			700	SHS: 280	1,050	SHS: 280				

* For a definition, see page 90.

Note 1. The following mode names and response times apply to the modes given in the Sensing distance column.

[E3X-HD] GIGA: Giga-power mode (16 ms), HS: High-speed mode (250 μs), ST: Standard mode (1 ms), and SHS: Super-high-speed mode (NPN output: 50 μs, PNP output: 55 μs)
[E3NX-FA] GIGA: Giga-power mode (16 ms), HS: High-speed mode (250 μs), ST: Standard mode (1 ms), and SHS: Super-high-speed mode (30 μs)

- 2.** The values for the minimum sensing object are reference values that indicate values obtained in standard mode with the sensing distance and sensitivity set to the optimum values. The first value is for the E3X-HD and the second value is for the E3NX-FA.

Through-beam Fiber Units (Set of 2)

17-A E32-T24R 2M (Free Cutting)

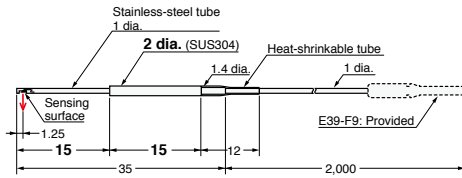

17-B E32-T24E 2M (Free Cutting)

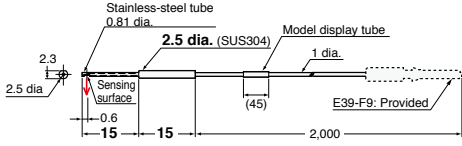

17-C E32-T33 1M (Free Cutting)

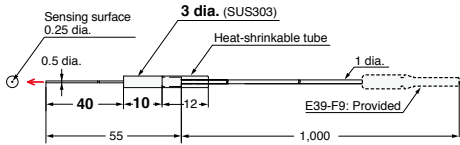

17-D E32-T21-S1 2M (Free Cutting)

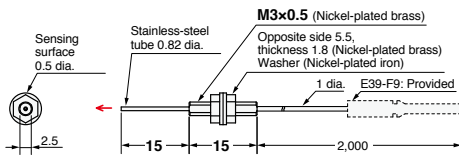

17-E E32-TC200BR 2M (Free Cutting)

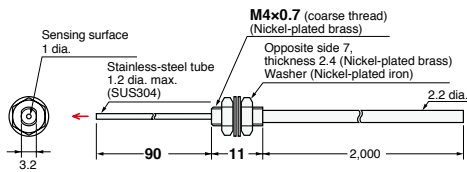

- Reference Information for Model Selection -

Bendable Sleeves

The E32-TC200BR has a bendable sleeve.
For best results, use the Sleeve Bender, which is sold separately.

Sleeve Bender (sold separately)

Appearance	Applicable Fiber Units	Model
 Use for the bending of the sleeve.	E32-TC200BR	E39-F11

Fiber Sensing Features	
Selection Guide	
Fiber Units	
Threaded	Standard Installation
Cylindrical	Standard Installation
Flat	Saving Space
Sleeved	Saving Space
Small Spot	Beam Improvements
High Power	
Narrow view	
BGS	Transparent Objects
Retro-reflective	
Limited-reflective	
Chemical-resistant, Oil-resistant	Environmental Immunity
Bending	
Heat-resistant	
Area Detection	Applications
Liquid-level	
Vacuum	
FPD, Semi, Solar	
Installation Information	
Fiber Amplifiers, Communications Unit, and Accessories	
Technical Guide and Precautions	
Model Index	

Threaded
Cylindrical

Flat
Sleeved

Small Spot
High Power
Narrow view
BGS

Retro-reflective
Limited-reflective

Bending
Heat-resistant

Liquid-level
Vacuum



- Sleeve Fiber Units allow detection away from the point of installation for stable close-range detection of small objects.
- Some Sleeve models can be bent.

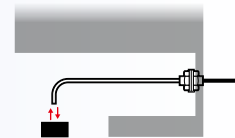

Specifications

Reflective Fiber Units

Sensing direction	Appearance (mm)	Bending radius of cable (mm)	Sensing distance (mm)				Optical axis diameter (minimum sensing object)	Models	Page 19 Dimensions No.	
			E3X-HD		E3NX-FA					
			GIGA	HS	Other modes	GIGA				HS
Side-view	The sleeve cannot be bent. IP67	Flexible*, R1	70	ST : 30	100	ST : 45	(5 μm dia./ 2 μm dia.)	E32-D24R 2M	19-A	
	Sleeve bending radius: 25 mm IP67	R25	120	ST : 53	180	ST : 79		E32-D24-S2 2M	19-B	
Top-view	The sleeve cannot be bent. IP67	R4	28	ST : 12	42	ST : 18		E32-D43M 1M	19-C	
	The sleeve cannot be bent. IP67		14	ST : 6	21	ST : 9		E32-D331 2M	19-D	
	The sleeve cannot be bent. IP67		70	ST : 30	100	ST : 45		E32-D33 2M	19-E	
	The sleeve cannot be bent. IP67		63	ST : 27	94	ST : 40		E32-D32-S1 0.5M	19-F	
	The sleeve cannot be bent. IP67		18	SHS: 7	27	SHS: 7		E32-D31-S1 0.5M	19-G	
	Sleeve bending radius: 5 mm IP67		Flexible*, R1	140	ST : 60	210		ST : 90	E32-DC200F4R 2M	19-H
	The sleeve cannot be bent. IP67		R10	250	ST : 110	370		ST : 160	E32-D22-S1 2M	19-I
	Sleeve bending radius: 10 mm IP67		R10	72	SHS: 30	100		SHS: 30	E32-D21-S3 2M	19-J
	The sleeve cannot be bent. IP67		Flexible*, R1	840	ST : 350	1,260	ST : 520	E32-DC200BR 2M	19-K	
	Sleeve bending radius: 10 mm IP67		R10	250	ST : 110	370	ST : 160	E32-D25-S3 2M	19-L	

* For a definition, see page 90.aper.

- Note 1.** The following mode names and response times apply to the modes given in the Sensing distance column.
[E3X-HD] GIGA: Giga-power mode (16 ms), HS: High-speed mode (250 μs), ST: Standard mode (1 ms), and SHS: Super-high-speed mode (NPN output: 50 μs, PNP output: 55 μs)
[E3NX-FA] GIGA: Giga-power mode (16 ms), HS: High-speed mode (250 μs), ST: Standard mode (1 ms), and SHS: Super-high-speed mode (30 μs)
- 2.** The values for the minimum sensing object are reference values that indicate values obtained in standard mode with the sensing distance and sensitivity set to the optimum values.
The first value is for the E3X-HD and the second value is for the E3NX-FA.
- 3.** The sensing distances for Reflective Fiber Units are for white paper.

Reflective Fiber Units

19-A E32-D24R 2M (Free Cutting)

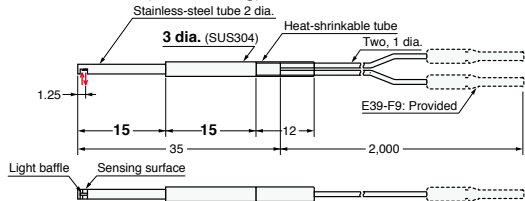

19-B E32-D24-S2 2M (Free Cutting)

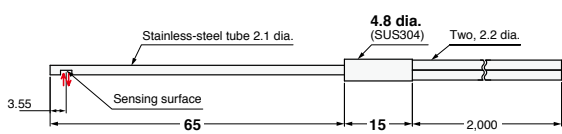

19-C E32-D43M 1M (No Cutting)

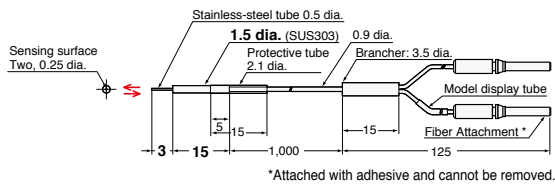

19-D E32-D331 2M (No Cutting)

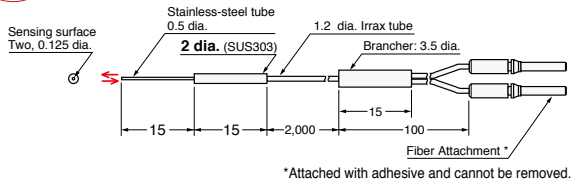

19-E E32-D33 2M (Free Cutting)

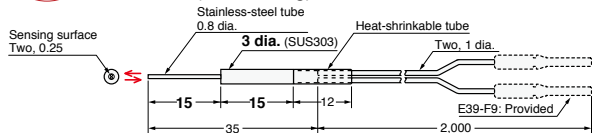

19-F E32-D32-S1 0.5M (No Cutting)

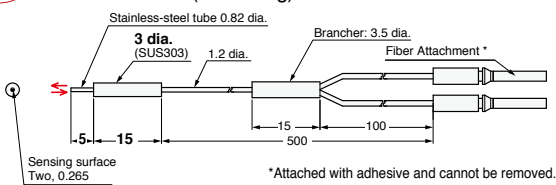

19-G E32-D31-S1 0.5M (No Cutting)

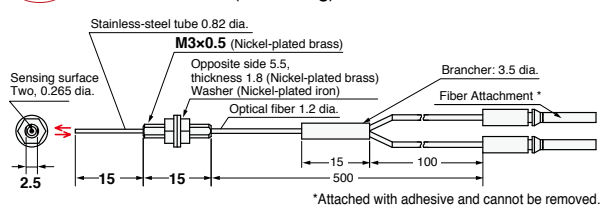

19-H E32-DC200F4R 2M (Free Cutting)

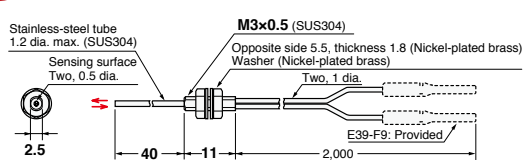

19-I E32-D22-S1 2M (Free Cutting)

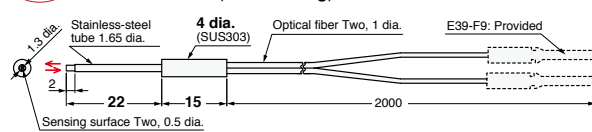

19-J E32-D21-S3 2M (Free Cutting)

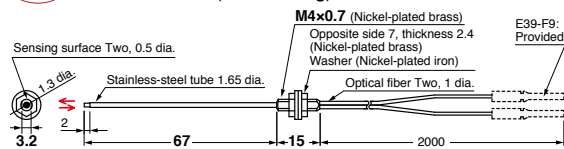

19-K E32-DC200BR 2M (Free Cutting)

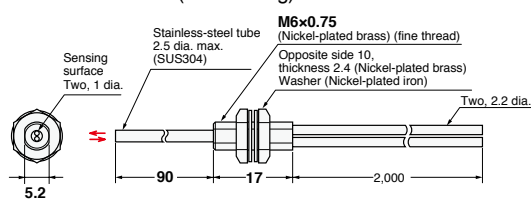

19-L E32-D25-S3 2M (Free Cutting)

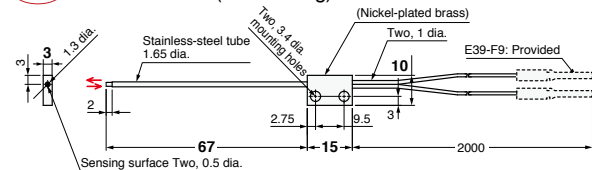

Fiber Sensing Features

Selection Guide

Fiber Units

Standard Installation

Saving Space

Beam Improvements

Transparent Objects

Environmental Immunity

Applications

Installation Information

Fiber Amplifiers, Communications Unit, and Accessories

Technical Guide and Precautions

Model Index

- Reference Information for Model Selection -

Bendable Sleeves

The E32-DC200F4R, E32-D21-S3 and E32-D25-S3 have bendable sleeves. For best results, use the Sleeve Bender, which is sold separately.

Sleeve Bender (sold separately)

Appearance	Applicable Fiber Units	Model
 Use for the bending of the sleeve.	E32-DC200F4R E32-D21-S3 E32-D25-S3	E39-F11

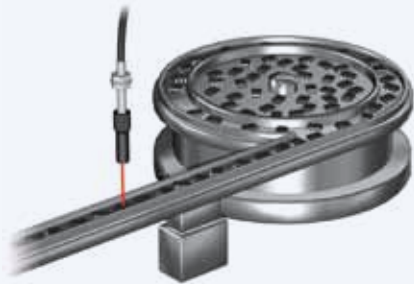

- Small-spot is ideal for detecting minute objects. Select the Fiber Unit that is best suited for the workpiece size and installation distance. (Refer to Reference Information for Model Selection)
- Available with a variable-spot Lens Unit to change the spot diameter without replacing the fiber. The spot diameter can be adjusted according to the size of the workpiece by changing the adjustor length and sensing distance. Refer to the following graph, which shows the relation between the adjustor length, focal distance, and spot diameter.

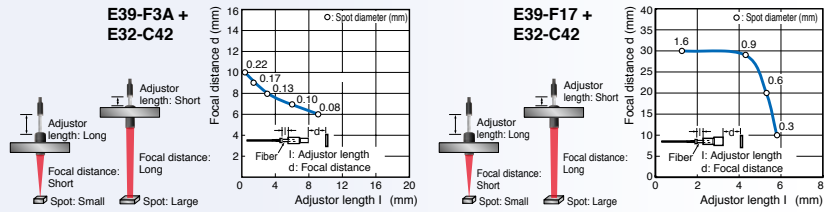

* Adjustor length: Approx. 1.3 to 5.8 mm

Specifications

Reflective Fiber Units

Variable-spot types

Lens Units + Fiber Unit

Type	Spot diameter	Center distance (mm)	Lens Units	Lens Units + Fiber Units	Fiber Unit		Page 21 Dimensions No.
			Models	Appearance (mm)	Bending radius of cable (mm)	Model	
Variable spot	0.1 to 0.6 dia.	6 to 15	E39-F3A		R25	E32-C42 1M	21-A
			E39-F17				21-B

Parallel-light-spot types

Lens Units + Fiber Unit

Type	Spot diameter	Center distance (mm)	Lens Units	Lens Units + Fiber Units	Fiber Unit		Page 21 Dimensions No.
			Model	Appearance (mm)	Bending radius of cable (mm)	Models	
Parallel light	4 dia.	0 to 20	E39-F3C		R25	E32-C31 2M	21-C
							Flexible**, R4

Small-spot types

Integrated Lens

Type	Spot diameter	Center distance (mm)	Appearance (mm)	Bending radius of cable (mm)	Models	Page 21 Dimensions No.
Short-distance, Small-spot	0.1 dia.	5	 Lens: unnecessary IP50	R25	E32-C42S 1M	21-E
Long-distance, Small-spot	6 dia.	50	 Lens: unnecessary IP50		E32-L15 2M	21-F

* The spot diameter and the center distance are the same when using with E3X-HD series or E3NX-FA series.

** For a definition, see page 90.

Reflective Fiber Units

21-A E32-C42 1M (No Cutting) + E39-F3A

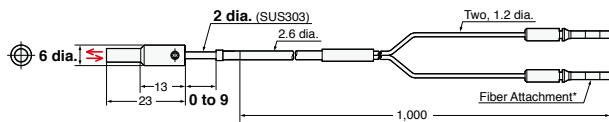

* Attached with adhesive and cannot be removed.
Note: There is a white tube on the emitter fiber.

E39-F3A

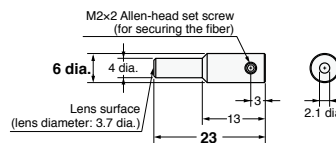

Material: Aluminum for body and optical glass for lens.
Note: This is the Lens Unit for the E32-C42.

21-B E32-C42 1M (No Cutting) + E39-F17

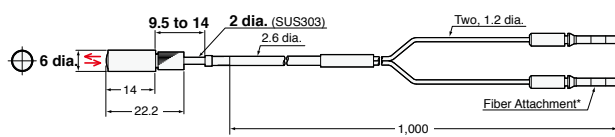

* Attached with adhesive and cannot be removed.
Note: There is a white tube on the emitter fiber.

E39-F17

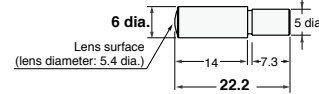

Material: Aluminum for body and optical glass for lens.

21-C E32-C31 2M (Free Cutting) + E39-F3C

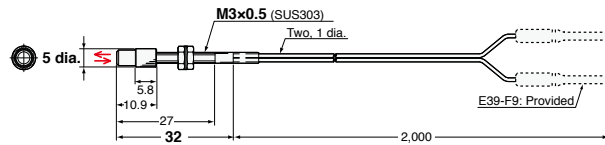

Note: There is a white line on the emitter fiber.

E39-F3C

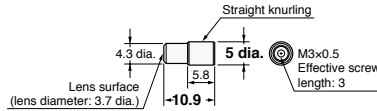

Material: Aluminum for body and optical glass for lens.
Note: This is the Lens Unit for the E32-C31 and E32-C31N.

21-D E32-C31N 2M (Free Cutting) + E39-F3C

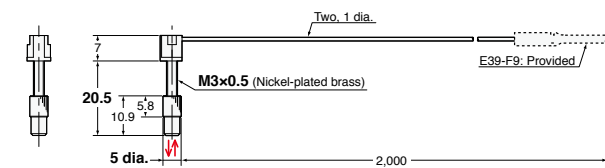

Note: There is a white line on the emitter fiber.

21-E E32-C42S 1M (No Cutting)

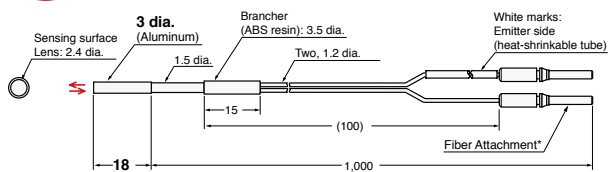

* Attached with adhesive and cannot be removed.
Note: There is a white tube on the emitter fiber.

21-F E32-L15 2M (Free Cutting)

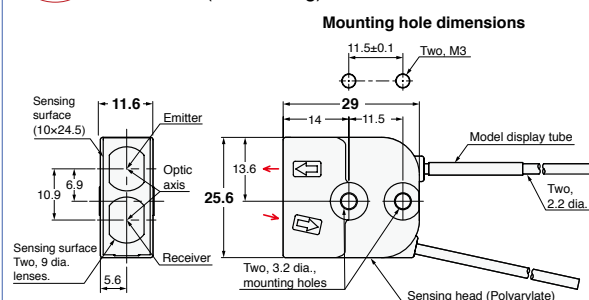

Note: There is a white tube on the emitter fiber.

- Reference Information for Model Selection -

Model Selection Tips

Select the best model by following these steps.

1. Select the model based on the spot diameter suitable for the workpiece size.
 * The Variable-spot Type is useful if there are different sensing object sizes.
2. Select the model based on the allowable installation distance and center distance.

<Map of Spot Diameters and Center Distances>

(Unit: mm)

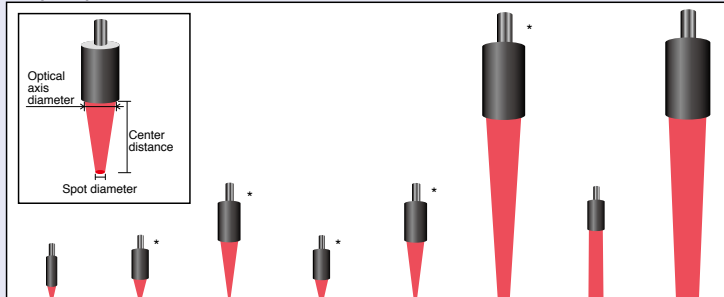

Spot diameter	0.1 dia.	0.1 dia.	0.2 dia.	0.5 dia.	0.5 dia.	3 dia.	4 dia.	6 dia.
Center distance	5	7	17	7	17	50	0 to 20	50
Optical axis diameter	2.4	3.7	4.8	3.7	4.8	9.4	3.7	10
Models	E32-C42S	E39-F3A-5 + E32-C41	E39-F3B + E32-C41	E39-F3A-5 + E32-C31 (N)	E39-F3B + E32-C31 (N)	E39-F18 + E32-CC200 E32-C11N	E39-F3C + E32-C31 (N)	E32-L15

* Refer to Page 22 for details.

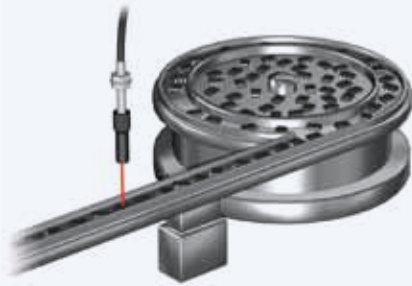

- Small-spot is ideal for detecting minute objects.
Select the Fiber Unit that is best suited for the workpiece size and installation distance.
(Refer to Reference Information for Model Selection)

Specifications

Reflective Fiber Units

Small-spot Models

Lens Units + Fiber Units

Type	Spot diameter	Center distance (mm)	Lens Units	Lens Units + Fiber Units	Fiber Units		Page 23 Dimensions No.	
			Models	Appearance (mm)	Bending radius of cable (mm)	Models		
Short-distance, small-spot	0.1 dia.	7	E39-F3A-5		R25		E32-C41 1M	23-A
	0.5 dia.						E32-C31 2M	23-B
						Flexible**, R4	E32-C31N 2M	23-C
Medium-distance, small-spot	0.2 dia.	17	E39-F3B		R25		E32-C41 1M	23-D
	0.5 dia.						E32-C31 2M	23-E
						Flexible**, R4	E32-C31N 2M	23-F
Long-distance, small-spot	3 dia.	50	E39-F18		R25		E32-CC200 2M	23-G
						Flexible**, R4	E32-C11N 2M	23-H

* The spot diameter and the center distance are the same when using with E3X-HD series or E3NX-FA series.

** For a definition, see page 90.

Reflective Fiber Units

23-A E32-C41 1M (No Cutting) + E39-F3A-5

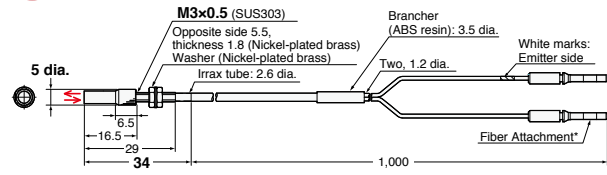

* Attached with adhesive and cannot be removed.
Note: There is a white tube on the emitter fiber.

23-B E32-C31 2M (Free Cutting) + E39-F3A-5

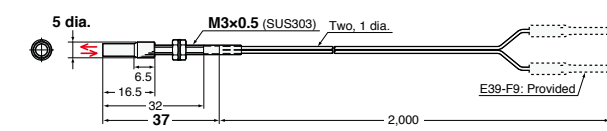

Note: There is a white line on the emitter fiber.

E39-F3A-5

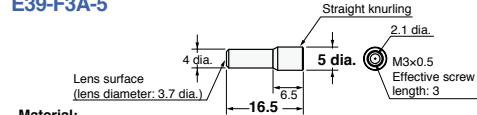

Material:
Aluminum for body and optical glass for lens

Note: This is a Lens Unit for the E32-C41, E32-C31 and E32-C31N.

23-C E32-C31N 2M (Free Cutting) + E39-F3A-5

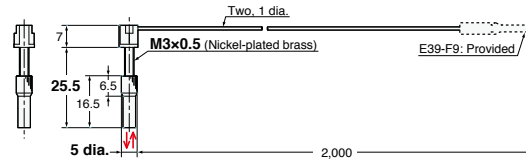

Note: There is a white line on the emitter fiber.

23-D E32-C41 1M (No Cutting) + E39-F3B

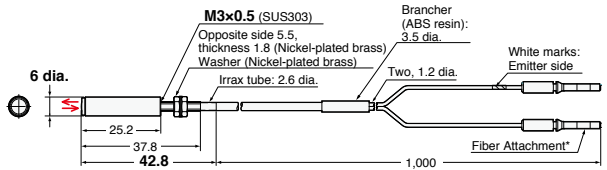

* Attached with adhesive and cannot be removed.
Note: There is a white tube on the emitter fiber.

E39-F3B

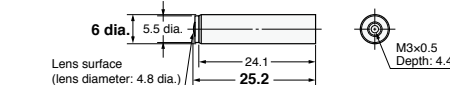

Material:
Aluminum for body and optical glass for lens

Note: This is a Lens Unit for the E32-C41, E32-C31 and E32-C31N.

23-E E32-C31 2M (Free Cutting) + E39-F3B

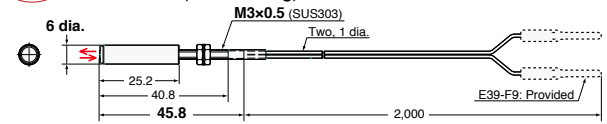

Note: There is a white line on the emitter fiber.

23-F E32-C31N 2M (Free Cutting) + E39-F3B

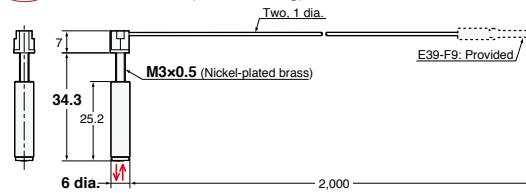

Note: There is a white line on the emitter fiber.

23-G E32-CC200 2M (Free Cutting) + E39-F18

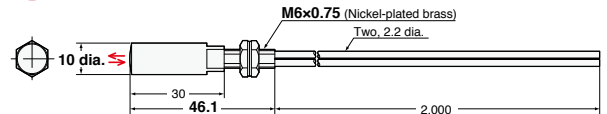

Note: There is a white line on the emitter fiber.

E39-F18

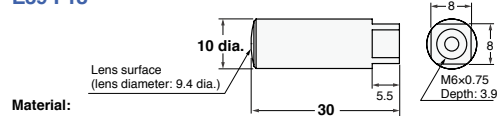

Material:
Aluminum for body and optical glass for lens

Note: This is a Lens Unit for the E32-C11N and E32-CC200.

23-H E32-C11N 2M (Free Cutting) + E39-F18

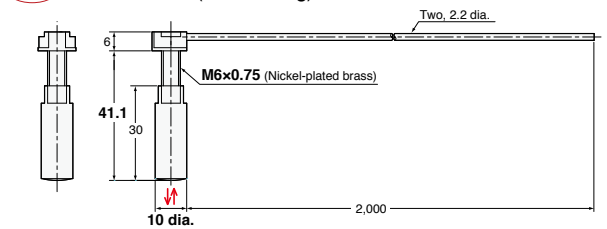

Note: There is a white line on the emitter fiber.

- Reference Information for Model Selection -

Model Selection Tips

Select the best model by following these steps.

1. Select the model based on the spot diameter suitable for the workpiece size.

* The Variable-spot Type is useful if there are different sensing object sizes.

2. Select the model based on the allowable installation distance and center distance.

<Map of Spot Diameters and Center Distances>

(Unit: mm)

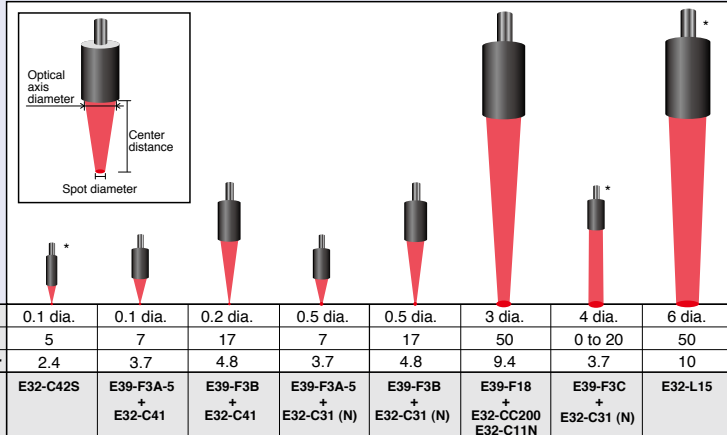

* Refer to Page 20 for details.

Fiber Sensing Features
 Selection Guide
 Fiber Units
 Threaded
 Cylindrical
 Flat
 Sleeved
 Small Spot
 High Power
 Narrow view
 BGS
 Retro-reflective
 Limited-reflective
 Chemical-resistant, Oil-resistant
 Bending
 Heat-resistant
 Area Detection
 Liquid-level
 Vacuum
 FPD, Semi, Solar
 Installation Information
 Fiber Amplifiers, Communications Unit, and Accessories
 Technical Guide and Precautions
 Model Index

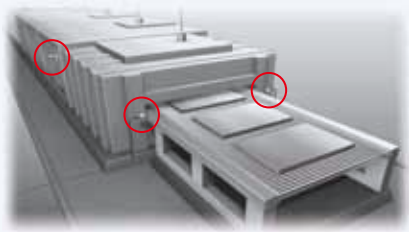

- Maximum sensing distance without attaching a Lens: 20 m (E32-T17L)
Suitable for detection of large objects and for use in large-scale installations.
- Powerful enough to resist the influences of dust and dirt.
- In addition to the products listed on this page, Lenses are available to extend the sensing distance. (→ [pages 26 to 29](#))

Specifications

Through-beam Fiber Units

Sensing direction	Aperture angle	Appearance (mm)	Bending radius of cable (mm)	Sensing distance (mm)				Optical axis diameter (minimum sensing object)	Models	Page 25 Dimensions No.
				E3X-HD		E3NX-FA				
				GIGA HS	Other modes	GIGA HS	Other modes			
Top-view	10°		R25	20,000 *1 20,000 *1	ST : 20,000 SHS: 8,000	20,000 *1 20,000 *1	ST : 20,000 SHS: 8,000	10 dia.	E32-T17L 10M	25-A
	15°		Flexible*, R1	4,000 *2 2,700	ST : 4,000 SHS: 1,080	4,000 *2 4,000 *2	ST : 4,000 SHS: 1,080	2.3 dia. (0.1 dia./0.03 dia.)	E32-LT11 2M	25-B
Side-view	30°		R25	4,000 *2 4,000 *2	ST : 4,000 SHS: 1,800	4,000 *2 4,000 *2	ST : 4,000 SHS: 1,800	4 dia. (0.1 dia./0.03 dia.)	E32-T14 2M	25-C

* For a definition, see page 90.

*1 The optical fiber is 10 m long on each side, so the sensing distance is 20,000 mm.

*2 The optical fiber is 2 m long on each side, so the sensing distance is 4,000 mm.

Reflective Fiber Units

Sensing direction	Aperture angle	Appearance (mm)	Bending radius of cable	Sensing distance (mm)				Optical axis diameter (minimum sensing object)	Model	Page 25 Dimensions No.
				E3X-HD		E3NX-FA				
				GIGA HS	Other modes	GIGA HS	Other modes			
Top-view	4°		Bend-resistant*3, R4	40 to 2,800 40 to 900	ST : 40 to 1,400 SHS: 40 to 480	40 to 4,000 *2 40 to 1,350	ST : 40 to 2,100 SHS: 40 to 480	-	E32-D16 2M	25-D

*3 Bend-resistant fibers are for repeated bending applications, whereas Flexible fibers are meant for routing around tight corners.

Note 1. The following mode names and response times apply to the modes given in the Sensing distance column.

[E3X-HD] GIGA: Giga-power mode (16 ms), HS: High-speed mode (250 μs), ST: Standard mode (1 ms), and SHS: Super-high-speed mode (NPN output: 50 μs, PNP output: 55 μs)
[E3NX-FA] GIGA: Giga-power mode (16 ms), HS: High-speed mode (250 μs), ST: Standard mode (1 ms), and SHS: Super-high-speed mode (30 μs)

2. The values for the minimum sensing object are reference values that indicate values obtained in standard mode with the sensing distance and sensitivity set to the optimum values.
The first value is for the E3X-HD and the second value is for the E3NX-FA.

3. The sensing distances for Reflective Fiber Units are for white paper.

Through-beam Fiber Units (Set of 2)

25-A E32-T17L 10M (Free Cutting)

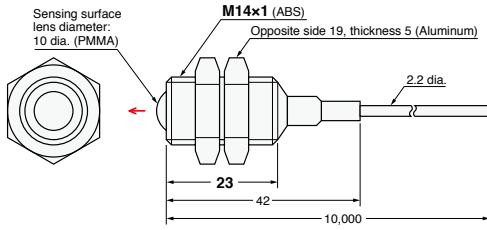

25-B E32-LT11 2M (Free Cutting)

E32-LT11R 2M (Free Cutting)

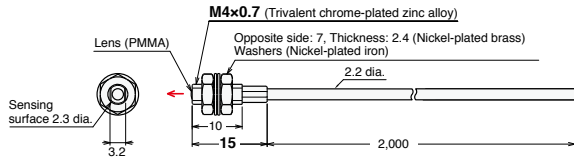

25-C E32-T14 2M (Free Cutting)

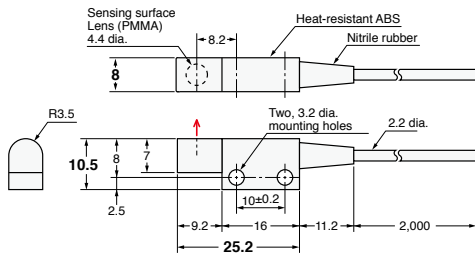

Installation Information → Page 58

Reflective Fiber Units

25-D E32-D16 2M (Free Cutting)

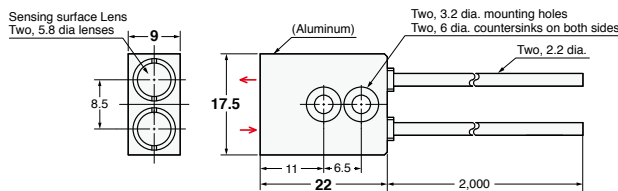

- Reference Information for Model Selection -

Comparisons of incident level

Select the model based on the comparisons of incident level against Standard Fiber Units.

Comparisons of incident level (Through-beam)

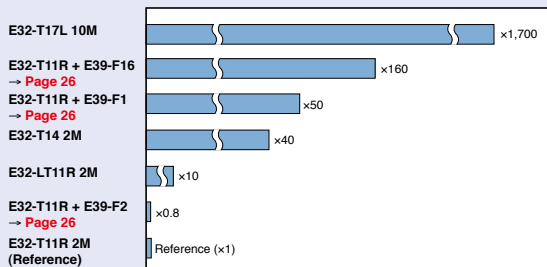

Comparisons of incident level (Reflective)

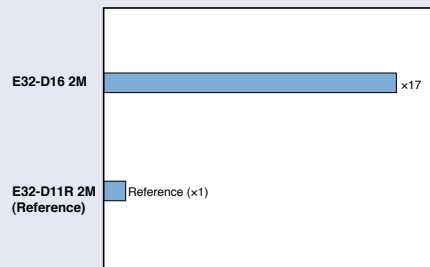

Fiber Sensing Features

Selection Guide

Fiber Units

Threaded Standard Installation

Cylindrical Saving Space

Flat

Sleeved

Small Spot

High Power Beam Improvements

Narrow view

BGS

Retro-reflective Transparent Objects

Limited-reflective

Chemical-resistant, Oil-resistant Environmental Immunity

Bending

Heat-resistant

Area Detection Applications

Liquid-level

Vacuum

FPD, Semi, Solar

Installation Information

Fiber Amplifiers, Communications Unit, and Accessories

Technical Guide and Precautions

Model Index

Through-beam Fiber Units

Lens Units		Type	High-power (incident level: 50 times)	Ultra-high-power (incident level: 160 times)	Side-View (incident level: 0.8 times)								
		Models	E39-F1	E39-F16	E39-F2								
Appearance													
Aperture angle		Approx. 12°	Approx. 6°	Approx. 60°									
Optical axis diameter (minimum sensing object)		4 dia. (0.1 dia.)	7.2 dia.	3 dia. (0.1 dia.)									
Fiber Units		Sensing distance (mm)											
Models	Appearance (mm)	E3X-HD		E3NX-FA		E3X-HD		E3NX-FA		E3X-HD		E3NX-FA	
		GIGA	HS	GIGA	HS	GIGA	HS	GIGA	HS	GIGA	HS	GIGA	HS
E32-T11N 2M		4,000*	ST : 4,000	4,000*	ST : 4,000	4,000*	ST : 4,000	4,000*	ST : 4,000	—	—	—	—
E32-T11R 2M		4,000*	ST : 4,000	4,000*	ST : 4,000	4,000*	ST : 4,000	4,000*	ST : 4,000	1,450	ST : 800	2,170	ST : 1,200
E32-T11 2M		4,000*	ST : 4,000	4,000*	ST : 4,000	4,000*	ST : 4,000	4,000*	ST : 4,000	2,300	ST : 1,320	3,450	ST : 1,980

* The optical fiber is 2 m long on each side, so the sensing distance is 4,000 mm.

Note 1. The following mode names and response times apply to the modes given in the Sensing distance column.

[E3X-HD] GIGA: Giga-power mode (16 ms), HS: High-speed mode (250 μs), ST: Standard mode (1 ms), and SHS: Super-high-speed mode (NPN output: 50 μs, PNP output: 55 μs)
 [E3NX-FA] GIGA: Giga-power mode (16 ms), HS: High-speed mode (250 μs), ST: Standard mode (1 ms), and SHS: Super-high-speed mode (30 μs)

2. The values for the minimum sensing object are reference values that indicate values obtained in standard mode with the sensing distance and sensitivity set to the optimum values.
 The first value is for the E3X-HD and the second value is for the E3NX-FA.

Dimensions

Installation Information → Page 61

Lens Units (Set of 2)

26-A E39-F1

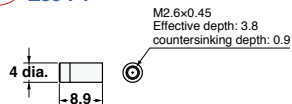

Material:
Brass for the body and optical glass for the lens itself.
Note: Two per set.

26-C E39-F2

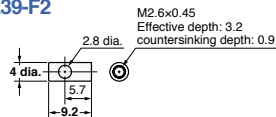

Material:
Brass for the body and optical glass for the lens itself.
Note: Two per set.

26-B E39-F16

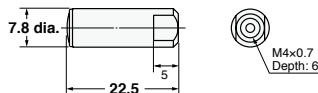

Material:
SUS303 for the body and optical glass for the lens itself.
Note: Two per set.

Threaded

Cylindrical

Flat

Sleeved

Small Spot

High Power

Narrow view

BGS

Retro-reflective

Limited-reflective

Chemical-resistant, Oil-resistant

Bending

Heat-resistant

Area Detection

Liquid-level

Vacuum

FPD, Semi, Solar

Through-beam Fiber Units (Set of 2)

27-A E32-T11N 2M (Free Cutting) + E39-F1



27-B E32-T11R 2M (Free Cutting) + E39-F1

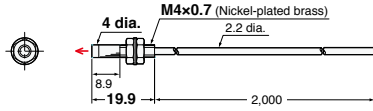

27-C E32-T11 2M (Free Cutting) + E39-F1

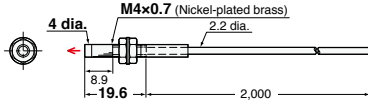

27-D E32-T11N 2M (Free Cutting) + E39-F16

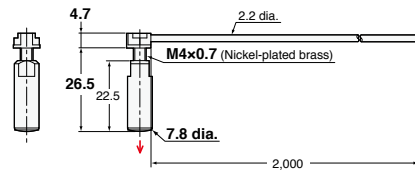

27-E E32-T11R 2M (Free Cutting) + E39-F16

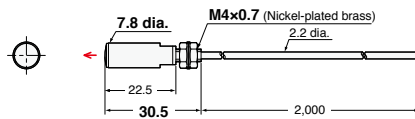

27-F E32-T11 2M (Free Cutting) + E39-F16

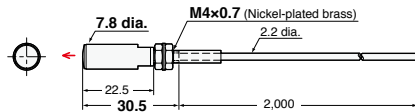

27-G E32-T11R 2M (Free Cutting) + E39-F2

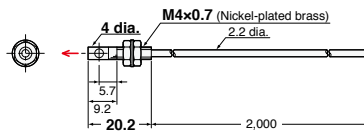

27-H E32-T11 2M (Free Cutting) + E39-F2

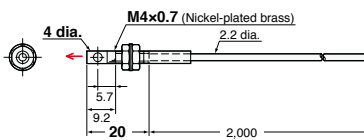

- Reference Information for Model Selection -

Comparisons of incident level

Select the model based on the comparisons of incident level against Standard Fiber Units.

Comparisons of incident level (Through-beam)

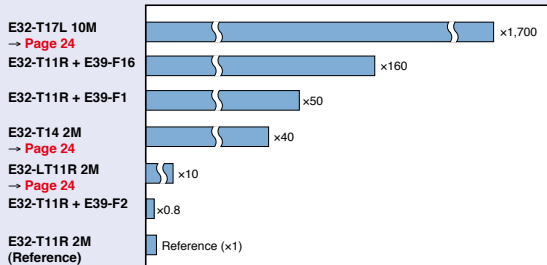

Threaded

Cylindrical

Flat

Sleeved

Small Spot

High Power

Narrow view

BGS

Retro-reflective

Limited-reflective

Chemical-resistant, Oil-resistant

Bending

Heat-resistant

Area Detection

Liquid-level

Vacuum

FPD, Semi, Solar

Standard Installation

Saving Space

Beam Improvements

Transparent Objects

Environmental Immunity

Applications



Installation Information

Fiber Amplifiers, Communications Unit, and Accessories

Technical Guide and Precautions



Model Index

Through-beam Fiber Units (Heat-resistant)

Lens Units	Type	High-power (incident level: 50 times)	Ultra-high-power (incident level: 160 times)	Side-View (incident level: 0.8 times)									
	Models	E39-F1	E39-F16	E39-F2									
Fiber Units	Appearance	 (28-A)	 (28-B)	 (28-C)									
	Aperture angle	Approx. 12°	Approx. 6°	Approx. 60°									
	Optical axis diameter (minimum sensing object)	4 dia. (0.1 dia.)	7.2 dia. (0.1 dia.)	3 dia. (0.1 dia.)									
	Models	Sensing distance (mm)											
Threaded	Heat-resistant up to 100°C	E3X-HD		E3NX-FA		E3X-HD		E3NX-FA		E3X-HD		E3NX-FA	
		GIGA HS	Other modes	GIGA HS	Other modes	GIGA HS	Other modes	GIGA HS	Other modes	GIGA HS	Other modes	GIGA HS	Other modes
Cylindrical	Heat-resistant up to 200°C	4,000*	ST : 4,000	4,000*	ST : 4,000	4,000*	ST : 4,000	4,000*	ST : 4,000	1,400	ST : 720	2,100	ST : 1,080
		3,900	SHS : 1,500 (29-A)	4,000*	SHS : 1,500	4,000*	SHS : 4,000 (29-D)	4,000*	SHS : 4,000	500	SHS : 200 (29-G)	750	SHS : 200
Flat	Heat-resistant up to 350°C (200°C) (See Note 3)	4,000*	ST : 4,000	4,000*	ST : 4,000	4,000*	ST : 4,000	4,000*	ST : 4,000	1,000	ST : 550	1,500	ST : 820
		2,700	SHS : 1,000 (29-B)	4,000*	SHS : 1,000	4,000*	SHS : 1,800 (29-E)	4,000*	SHS : 1,800	360	SHS : 140 (29-H)	540	SHS : 140
Sleeved	Heat-resistant up to 350°C (200°C) (See Note 3)	4,000*	ST : 4,000	4,000*	ST : 4,000	4,000*	ST : 4,000	4,000*	ST : 4,000	1,680	ST : 900	2,520	ST : 1,350
		4,000*	SHS : 1,800 (29-C)	4,000*	SHS : 1,800	4,000*	SHS : 3,100 (29-F)	4,000*	SHS : 3,100	600	SHS : 240 (29-I)	900	SHS : 240

* The optical fiber is 2 m long on each side, so the sensing distance is 4,000 mm.

- Note 1.** The following mode names and response times apply to the modes given in the Sensing distance column.
 [E3X-HD] GIGA: Giga-power mode (16 ms), HS: High-speed mode (250 μs), ST: Standard mode (1 ms), and SHS: Super-high-speed mode (NPN output: 50 μs, PNP output: 55 μs)
 [E3NX-FA] GIGA: Giga-power mode (16 ms), HS: High-speed mode (250 μs), ST: Standard mode (1 ms), and SHS: Super-high-speed mode (30 μs)
- Note 2.** The values for the minimum sensing object are reference values that indicate values obtained in standard mode with the sensing distance and sensitivity set to the optimum values. The first value is for the E3X-HD and the second value is for the E3NX-FA.
- Note 3.** The ambient temperature of E32-T61-S must be between -40 to 200°C when using it with E39-F1 or E39-F2 Lens Unit. The ambient temperature of E32-T61-S must be between -40 to 350°C when using it with E39-F16 Lens Unit.

Lens Units	Type	High-power (incident level: 50 times)	Ultra-high-power (incident level: 160 times)						
	Models	E39-F1-33	E39-F16						
Fiber Units	Appearance	 (28-D)	 (28-B)						
	Aperture angle	Approx. 12°	Approx. 6°						
	Optical axis diameter (minimum sensing object)	4 dia. (0.1 dia.)	7.2 dia. (0.1 dia.)						
	Models	Sensing distance (mm)							
Threaded	Heat-resistant up to 150°C	E3X-HD		E3NX-FA		E3X-HD		E3NX-FA	
		GIGA HS	Other modes	GIGA HS	Other modes	GIGA HS	Other modes	GIGA HS	Other modes
Cylindrical	Heat-resistant up to 150°C	4,000*	ST : 4,000	4,000*	ST : 4,000	4,000*	ST : 4,000	4,000*	ST : 4,000
		2,300	SHS : 1,400 (29-J)	3,450	SHS : 1,400	4,000*	SHS : 4,000 (29-K)	4,000*	SHS : 4,000

* The optical fiber is 2 m long on each side, so the sensing distance is 4,000 mm.

- Note 1.** The following mode names and response times apply to the modes given in the Sensing distance column.
 [E3X-HD] GIGA: Giga-power mode (16 ms), HS: High-speed mode (250 μs), ST: Standard mode (1 ms), and SHS: Super-high-speed mode (NPN output: 50 μs, PNP output: 55 μs)
 [E3NX-FA] GIGA: Giga-power mode (16 ms), HS: High-speed mode (250 μs), ST: Standard mode (1 ms), and SHS: Super-high-speed mode (30 μs)
- Note 2.** The values for the minimum sensing object are reference values that indicate values obtained in standard mode with the sensing distance and sensitivity set to the optimum values. The first value is for the E3X-HD and the second value is for the E3NX-FA.

Dimensions

Installation Information → Page 61

Lens Units (Set of 2)

(28-A) E39-F1

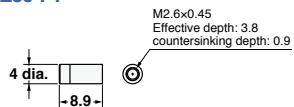

Material: Brass for the body and optical glass for the lens itself.

Note: Two per set.

(28-B) E39-F16

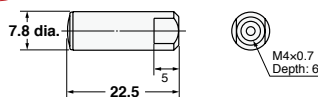

Material: SUS303 for the body and optical glass for the lens itself.

Note: Two per set.

(28-C) E39-F2

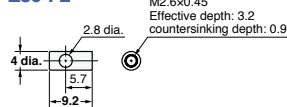

Material: Brass for the body and optical glass for the lens itself.

Note: Two per set.

(28-D) E39-F1-33

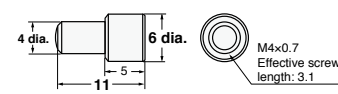

Material: Brass for the body and optical glass for the lens itself.

Note 1: Two per set.
Note 2: This is the Lens Unit for the E32-T51.

Through-beam Fiber Units (Set of 2)

29-A E32-T51R 2M (Free Cutting) + E39-F1

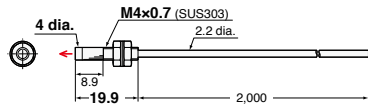

29-B E32-T81R-S 2M (No Cutting) + E39-F1

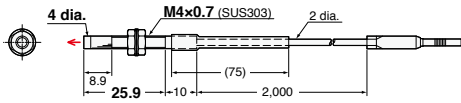

29-C E32-T61-S 2M (No Cutting) + E39-F1

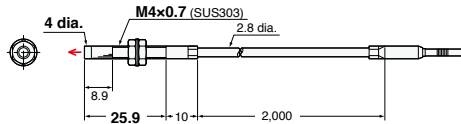

29-G E32-T51R 2M (Free Cutting) + E39-F2

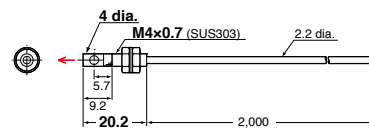

29-H E32-T81R-S 2M (No Cutting) + E39-F2

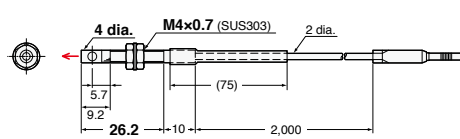

29-I E32-T61-S 2M (No Cutting) + E39-F2

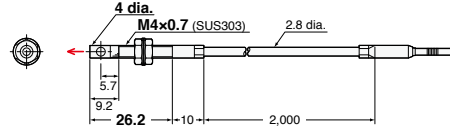

29-D E32-T51R 2M (Free Cutting) + E39-F16

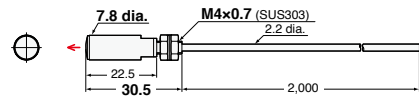

29-E E32-T81R-S 2M (No Cutting) + E39-F16

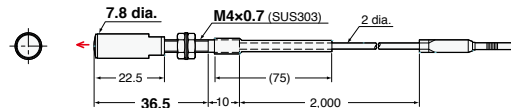

29-F E32-T61-S 2M (No Cutting) + E39-F16

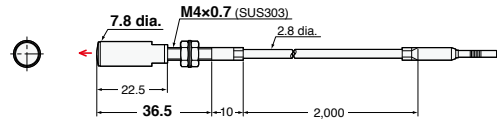

29-J E32-T51 2M (Free Cutting) + E39-F1-33

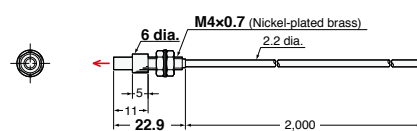

29-K E32-T51 2M (Free Cutting) + E39-F16

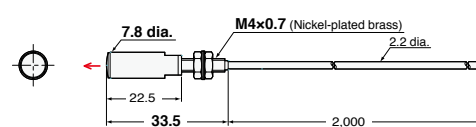

- Reference Information for Model Selection -

Comparisons of incident level

Select the model based on the comparisons of incident level against Standard Fiber Units.

Comparisons of incident level (Through-beam)

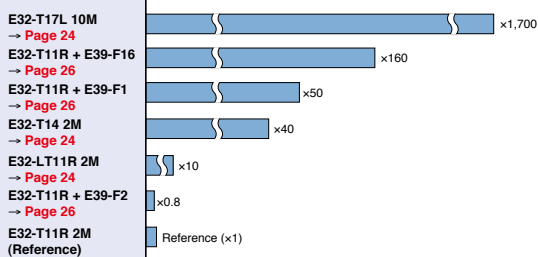

Fiber Senso Features	
Selection Guide	
Fiber Units	
Threaded	Standard Installation
Cylindrical	
Flat	Saving Space
Sleeved	
Small Spot	Beam Improvements
High Power	
Narrow view	
BGS	
Retro-reflective	Transparent Objects
Limited-reflective	
Chemical-resistant, Oil-resistant	Environmental Immunity
Bending	
Heat-resistant	
Area Detection	Applications
Liquid-level	
Vacuum	
FPD, Semi, Solar	
Installation Information	
Fiber Amplifiers, Communications Unit, and Accessories	
Technical Guide and Precautions	
Model Index	

Threaded

Cylindrical

Flat

Sleeved

Small Spot

High Power

Narrow
view

BGS

Retro-
reflectiveLimited-
reflectiveChemical-
resistant,
Oil-resistant

Bending

Heat-
resistantArea
Detection

Liquid-level

Vacuum

- A narrow beam prevents false detection of light that is reflected off surrounding objects.

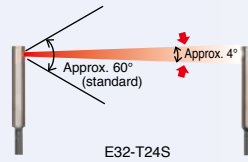
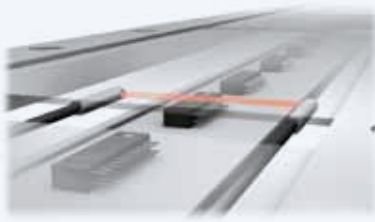

Specifications

Through-beam Fiber Units

Sensing direction	Aperture angle	Appearance (mm)	Bending radius of cable (mm)	Sensing distance (mm)				Optical axis diameter (minimum sensing object)	Models	Page 31 Dimensions No.	
				E3X-HD		E3NX-FA					
				GIGA-HS	Other modes	GIGA-HS	Other modes				
Side-view	1.5°		Flexible**, R1	4,000*	ST : 1,780	4,000*	ST : 2,670	2 dia. (0.1 dia./ 0.03 dia.)	E32-A03 2M	31-A	
				1,200	SHS: 500	1,800	SHS: 500				
	3.4°		R10	1,280	ST : 680	1,920	ST : 1,020		1.2 dia. (0.1 dia./ 0.03 dia.)	E32-A04 2M	31-C
				450	SHS: 200	670	SHS: 200				
	4°		Flexible**, R1	4,000*	ST : 2,200	4,000*	ST : 3,300		2 dia. (0.1 dia./ 0.03 dia.)	E32-T24SR 2M	31-D
				1,460	SHS: 580	2,190	SHS: 580				
R10		R10	4,000*	ST : 2,600	4,000*	ST : 3,900	E32-T24S 2M	31-E			
			1,740	SHS: 700	2,610	SHS: 700					
Top-view			R10	4,000*	ST : 3,800	4,000*	ST : 4,000	1.7 dia. (0.1 dia./ 0.03 dia.)		E32-T22S 2M	31-F
				2,500	SHS: 1,000	3,750	SHS: 1,000				

* The optical fiber is 2 m long on each side, so the sensing distance is 4,000 mm.

** For a definition, see page 90.

Note 1. The following mode names and response times apply to the modes given in the Sensing distance column.

[E3X-HD] GIGA: Giga-power mode (16 ms), HS: High-speed mode (250 μs), ST: Standard mode (1 ms), and SHS: Super-high-speed mode (NPN output: 50 μs, PNP output: 55 μs)

[E3NX-FA] GIGA: Giga-power mode (16 ms), HS: High-speed mode (250 μs), ST: Standard mode (1 ms), and SHS: Super-high-speed mode (30 μs)

- 2.** The values for the minimum sensing object are reference values that indicate values obtained in standard mode with the sensing distance and sensitivity set to the optimum values. The first value is for the E3X-HD and the second value is for the E3NX-FA.

Through-beam Fiber Units (Set of 2)

31-A E32-A03 2M (Free Cutting)

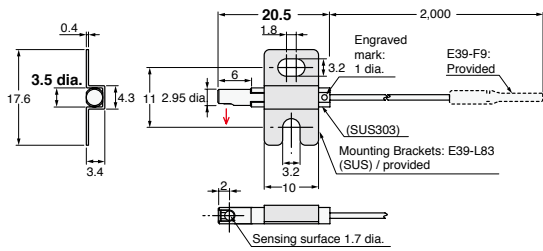

Note: Use the engraved surface and its opposing surface as installation (reference) surfaces.

31-B E32-A03-1 2M (Free Cutting)

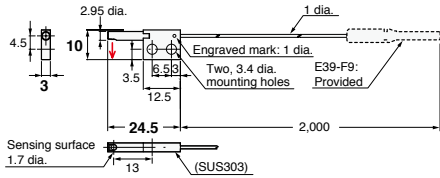

Note 1: Use the engraved surface and its opposing surface as installation (reference) surfaces.
 Note 2: Set of two symmetrically shaped Fiber Units.

31-C E32-A04 2M (Free Cutting)

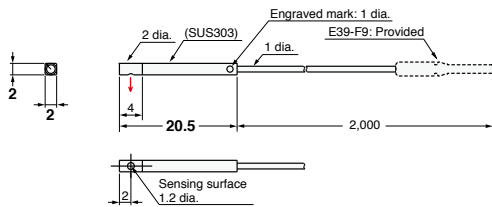

Note: Use the engraved surface and its opposing surface as installation (reference) surfaces.

31-D E32-T24SR 2M (Free Cutting)

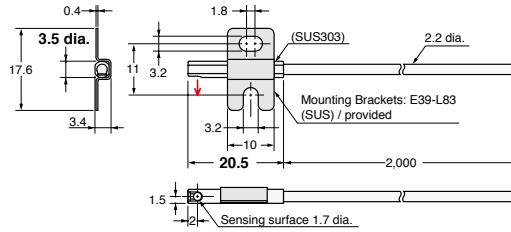

31-E E32-T24S 2M (Free Cutting)

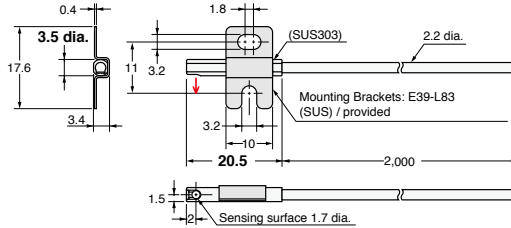

31-F E32-T22S 2M (Free Cutting)

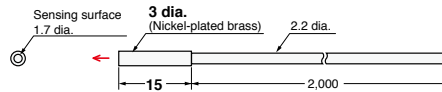

- Reference Information for Model Selection -

Aperture angle and Optical Axis Diameter

The Aperture angle is the output angle of the emitted beam, and the optical axis diameter is the core diameter of the emitter fiber. A fiber with a narrow view has a larger optical axis diameter than standard fibers, but the aperture angle is smaller so it is not influenced by surrounding objects.

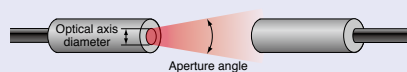

Fiber Sensing Features	
Selection Guide	
Fiber Units	
Threaded	Standard Installation
Cylindrical	
Flat	Saving Space
Sleeved	
Small Spot	Beam Improvements
High Power	
Narrow view	
BGS	
Retro-reflective	Transparent Objects
Limited-reflective	
Chemical-resistant, Oil-resistant	Environmental Immunity
Bending	
Heat-resistant	
Area Detection	Applications
Liquid-level	
Vacuum	
FPD, Semi, Solar	
Installation Information	
Fiber Amplifiers, Communications Unit, and Accessories	
Technical Guide and Precautions	
Model Index	

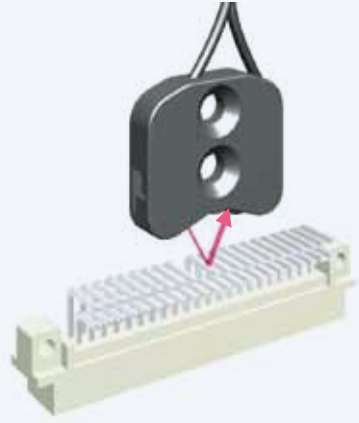

- These Fiber Units detect only objects in the sensing range. Objects in the background that are located beyond a certain point are not detected. They are not easily affected by the material or color of the sensing object.

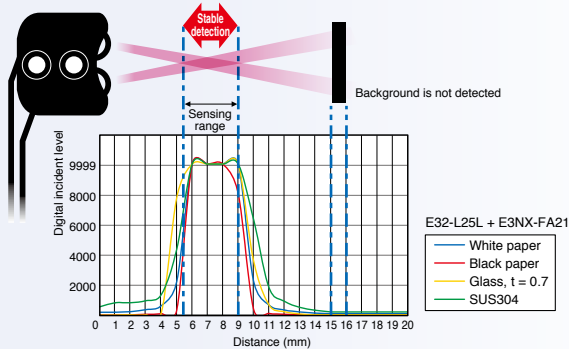

Specifications

Limited-reflective Fiber Units

Sensing direction	Appearance (mm)	Bending radius of cable (mm)	Sensing distance (mm)				Standard sensing object (minimum sensing object)	Models	Page 33 Dimensions No.
			E3X-HD		E3NX-FA				
			GIGA	HS	GIGA	HS			
Flat-view		R25	0 to 15	ST : 0 to 15	0 to 15	ST : 0 to 15	Soda glass with reflection factor of 7%	E32-L16-N 2M	33-A
			0 to 15	SHS: 0 to 12	0 to 15	SHS: 0 to 12			
Side-view		R10	0 to 4	ST : 0 to 4	0 to 4	ST : 0 to 4	(5 μm dia./ 2 μm dia.)	E32-L24S 2M	33-B
			5.4 to 9	ST : 5.4 to 9	5.4 to 9	ST : 5.4 to 9			
			5.4 to 9	SHS: 5.4 to 9	5.4 to 9	SHS: 5.4 to 9		E32-L25L 2M	33-C
			(Center 7.2)	(Center 7.2)	(Center 7.2)	(Center 7.2)			

- Note 1.** If operation is affected by the background, perform power tuning or use the ECO Mode to decrease the incident light level.
- 2.** The following mode names and response times apply to the modes given in the Sensing distance column.
 [E3X-HD] GIGA: Giga-power mode (16 ms), HS: High-speed mode (250 μs), ST: Standard mode (1 ms), and SHS: Super-high-speed mode (NPN output: 50 μs, PNP output: 55 μs)
 [E3NX-FA] GIGA: Giga-power mode (16 ms), HS: High-speed mode (250 μs), ST: Standard mode (1 ms), and SHS: Super-high-speed mode (30 μs)
- 3.** The values for the minimum sensing object are reference values that indicate values obtained in standard mode with the sensing distance and sensitivity set to the optimum values.
 The first value is for the E3X-HD and the second value is for the E3NX-FA.
- 4.** The sensing distances for Reflective Fiber Units are for white paper.

Threaded
Cylindrical

Flat
Sleeved

Small Spot
High Power
Narrow view
BGS

Retro-reflective
Limited-reflective

Chemical-resistant, Oil-resistant
Bending
Heat-resistant

Area Detection
Liquid-level
Vacuum
FPD, Semi, Solar

Threaded

Cylindrical

Flat

Sleeved

Small Spot

High Power

Narrow view

BGS

Retro-reflective

Limited-reflective

Chemical-resistant,
Oil-resistant

Bending

Heat-resistant

Area
Detection

Liquid-level

Vacuum

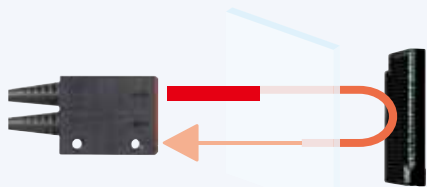
FPD,
Semi,
Solar

- Retro-reflective Fiber Units are ideal for detecting transparent objects. The light beam passes through the object twice, rather than only once like a Through-beam model.

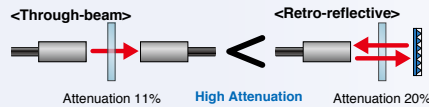

- Excellent detection performance with transparent films. (E32-C31 2M + E39-F3R)

The specially designed filter eliminates undesirable light, which allows significantly more light to be interrupted for stable detection of films.

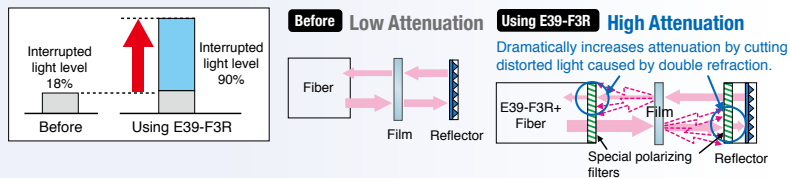

Specifications

Retro-reflective Fiber Units

Type	Features	Size	Appearance (mm)	Bending radius of cable (mm)	Sensing distance (mm)				Optical axis diameter (minimum sensing object)	Models	Page 35 Dimensions No.
					E3X-HD		E3NX-FA				
					GIGA	HS	Other modes	GIGA			
Film detection *	M3	M3		R25	250	ST : 250	370	ST : 370	-	E32-C31 2M + E39-F3R + E39-RP37	35-A
					200	-	300	-			
Square	-	-		R10	150 to 1,500	ST : 150 to 1,500	150 to 2,250	ST : 150 to 2,250	(0.2 dia./ 0.07 dia.)	E32-R16 2M	35-B
					150 to 1,500	SHS: 150 to 1,500	150 to 2,250	SHS: 150 to 1,500			
Threaded Models	M6	M6		R10	10 to 250	ST : 10 to 250	10 to 370	ST : 10 to 370	(0.1 dia./ 0.03 dia.)	E32-R21 2M	35-C
					10 to 250	SHS: 10 to 250	10 to 370	SHS: 10 to 250			

* This effect may not be as strong for some films. Detection may be unstable if the object is placed directly in front of the Lens Unit. Check suitability beforehand.

Note 1. Objects with a high reflection factor may cause the Fiber Sensor to detect reflected light as incident light.

2. The following mode names and response times apply to the modes given in the Sensing distance column.

[E3X-HD] GIGA: Giga-power mode (16 ms), HS: High-speed mode (250 μ s), ST: Standard mode (1 ms), and SHS: Super-high-speed mode (NPN output: 50 μ s, PNP output: 55 μ s)

[E3NX-FA] GIGA: Giga-power mode (16 ms), HS: High-speed mode (250 μ s), ST: Standard mode (1 ms), and SHS: Super-high-speed mode (30 μ s)

3. The values for the minimum sensing object are reference values that indicate values obtained in standard mode with the sensing distance and sensitivity set to the optimum values.

The first value is for the E3X-HD and the second value is for the E3NX-FA.

Retro-reflective Fiber Units

35-A E32-C31 2M (Free Cutting) + E39-F3R

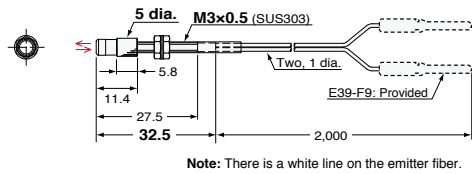

E39-F3R

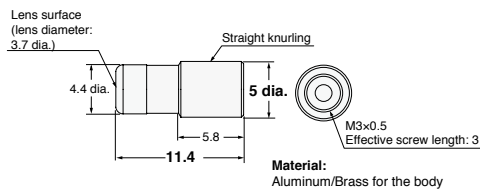

E39-RP37

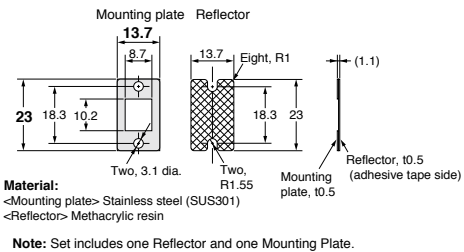

35-B E32-R16 2M (Free Cutting)

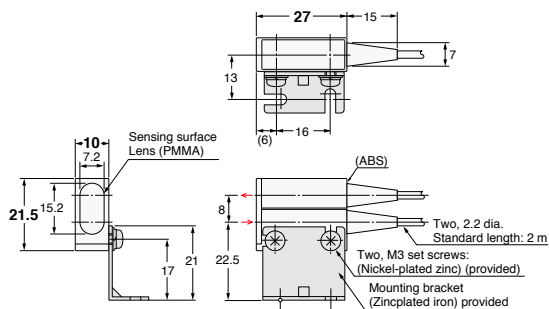

E39-R1 (Provided)

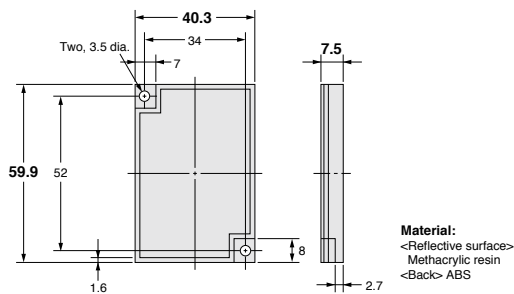

35-C E32-R21 2M (Free Cutting)

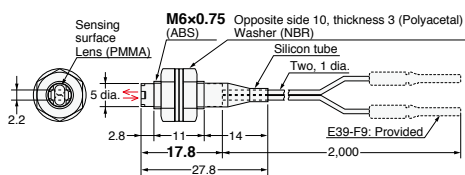

E39-R3 (Provided)

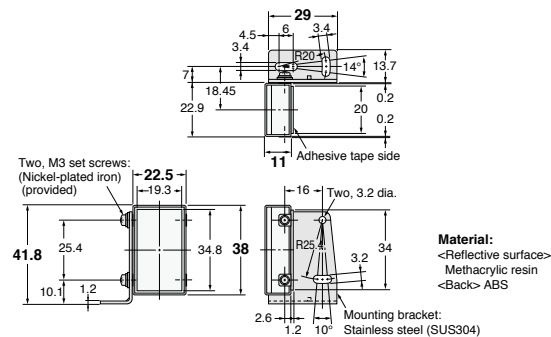

- Reference Information for Model Selection -

Performance Comparison of Transparent Object Detection

For detecting transparent objects, consider using the following combination: E32-C31, E39-F3R and E39-RP37.

- This configuration features a special built-in optical filter that ensures stable detection of double-refractive materials, such as films and PET bottles.
- The retro-reflective model is suitable for detecting glass.

We also offer two models with an integrated lens for detecting glass to prevent lens loss.

	Sensing object	Film wrapper on cigarette packs	PET bottles	Glass bottles	Plate glass, t: 0.7
Models					
E32-C31 2M + E39-F3R + E39-RP37		⊙	⊙	○	○
E32-R16 2M		△	△	○	○
E32-R21 2M		△	△	○	○

△ = good
○ = better
⊙ = best

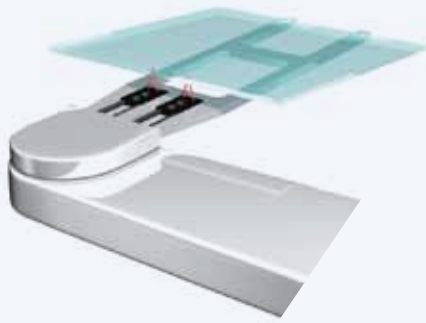

- These Fiber Units are based on a limited-reflective optical system where the emitting light and receiving light axes intersect at the same angle. This allows for stable detection of glass because the Fiber Units receives the specular reflection of the glass when the glass is in the sensing range.

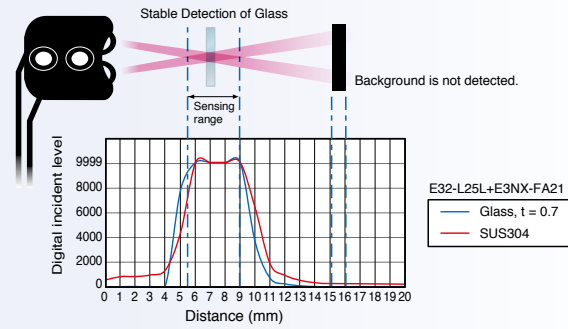

Specifications

Limited-reflective Fiber Units

Type	Features	Detection direction	Appearance (mm)	Bending radius of cable (mm)	Sensing distance (mm)				Standard sensing object (minimum sensing object)	Models	Page 37 Dimensions No.
					E3X-HD		E3NX-FA				
					GIGA	HS	Other modes	GIGA			
Small size	Flat-view	R10		R10	0 to 4	ST : 0 to 4	0 to 4	ST : 0 to 4	(5 μm dia./ 2 μm dia.)	E32-L24S 2M	37-A
			0 to 4		SHS: 0 to 4	0 to 4	SHS: 0 to 4				
			0 to 15		ST : 0 to 15	0 to 15	ST : 0 to 15				
			0 to 15		SHS: 0 to 12	0 to 15	SHS: 0 to 12				
Standard	Flat-view	R25		R25	10 to 20	ST : 10 to 20	10 to 20	ST : 10 to 20	Soda glass with reflection factor of 7%	E32-A08 2M	37-C
			10 to 20		SHS: -	10 to 20	SHS: -				
Standard long distance	Flat-view	R25		R25	12 to 30	ST : 12 to 30	12 to 30	ST : 12 to 30	Soda glass with reflection factor of 7%	E32-A12 2M	37-D
			12 to 30		SHS: -	12 to 30	SHS: -				
Side View form	Side-view	R10		R10	5.4 to 9	ST : 5.4 to 9	5.4 to 9	ST : 5.4 to 9	(5 μm dia./ 2 μm dia.)	E32-L25L 2M	37-E
Glass-substrate Mapping, 70°C	Top-view	R25		R25	15 to 38	ST : 15 to 38 (Center 25)	15 to 38	ST : 15 to 38 (Center 25)	End surface of soda glass with reflection factor of 7% (t = 0.7 mm, rounded edges)	E32-A09 2M	37-F

* If the background influences the sensing accuracy, perform power tuning or use the ECO mode to decrease the incident light level.

- Note 1.** The following mode names and response times apply to the modes given in the Sensing distance column.
 [E3X-HD] GIGA: Giga-power mode (16 ms), HS: High-speed mode (250 μs), ST: Standard mode (1 ms), and SHS: Super-high-speed mode (NPN output: 50 μs, PNP output: 55 μs)
 [E3NX-FA] GIGA: Giga-power mode (16 ms), HS: High-speed mode (250 μs), ST: Standard mode (1 ms), and SHS: Super-high-speed mode (30 μs)
- Note 2.** The values for the minimum sensing object are reference values that indicate values obtained in standard mode with the sensing distance and sensitivity set to the optimum values. The first value is for the E3X-HD and the second value is for the E3NX-FA.
- Note 3.** The sensing distances for Reflective Fiber Units are for white paper.

Limited-reflective Fiber Units

37-A E32-L24S 2M (Free Cutting)

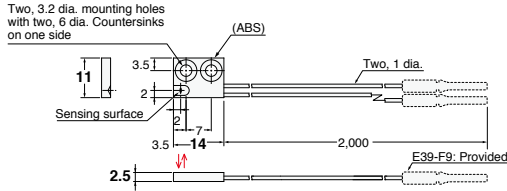

37-B E32-L16-N 2M (Free Cutting)

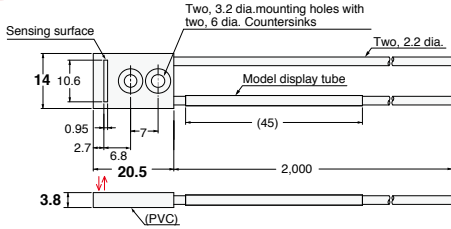

37-C E32-A08 2M (Free Cutting)

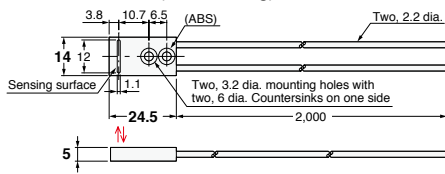

37-D E32-A12 2M (Free Cutting)

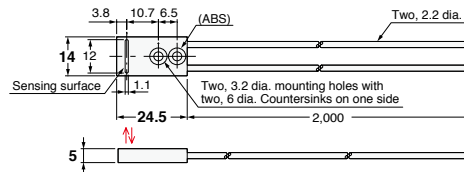

37-E E32-L25L 2M (Free Cutting)

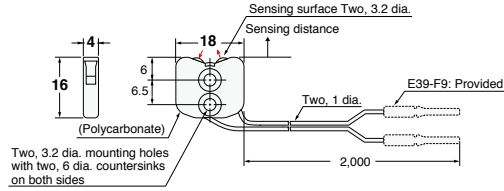

37-F E32-A09 2M (Free Cutting)

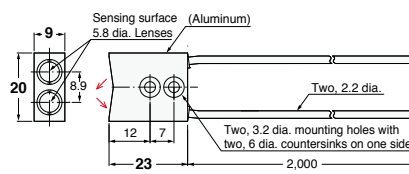

- Reference Information for Model Selection -

Sensing Distance vs. Digital Value

Limited-reflective Fiber Unit can keep high digital value within the sensing area for glass.
The digital value gets lower out of the sensing area for metals, including SUS (common as background).

— Glass, t = 0.7
— SUS304

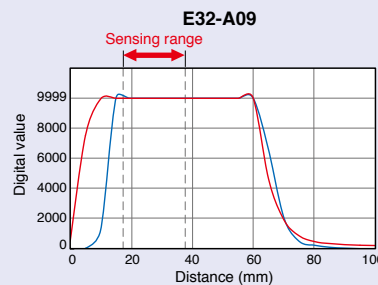
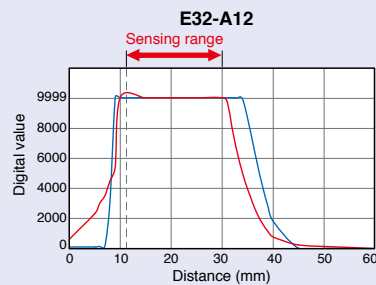
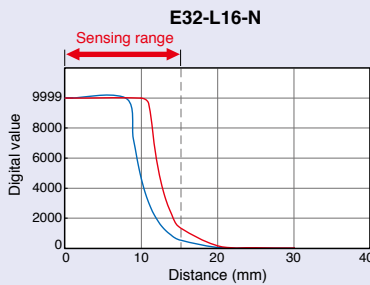
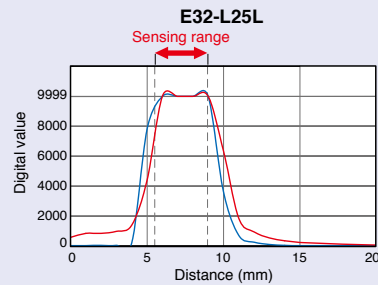
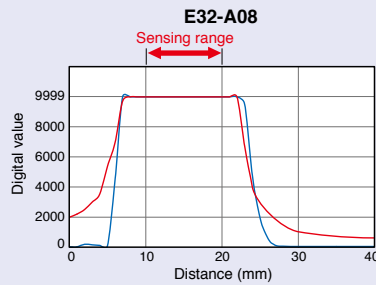
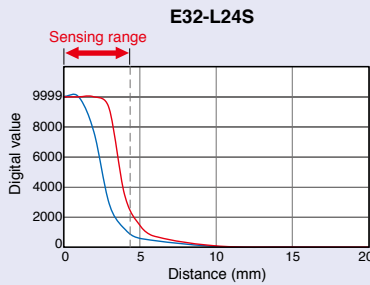

* E3NX-FA21 used in high-speed (HS) mode.

Fiber Senso Features	
Selection Guide	
Fiber Units	
Threaded	Standard Installation
Cylindrical	
Flat	Saving Space
Sleeved	
Small Spot	Beam Improvements
High Power	
Narrow view	
BGS	
Retro-reflective	Transparent Objects
Limited-reflective	
Chemical-resistant, Oil-resistant	Environmental Immunity
Bending	
Heat-resistant	
Area Detection	Applications
Liquid-level	
Vacuum	
FPD, Semi, Solar	
Installation Information	
Fiber Amplifiers, Communications Unit, and Accessories	
Technical Guide and Precautions	
Model Index	

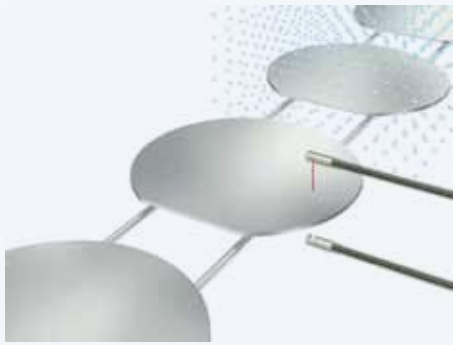

• These Fiber Units are made from fluororesin for resistance to chemicals.

Chemical-resistant Data for Fluororesin (Reference)

Chemical	Fluororesin	Acryl	ABS	Polycarbonate	Polyethylene	PVC
Hydrochloric acid	◎	△	△	△	△	×
Sulfuric acid	◎	×	×	×	×	×
Sodium hydroxide	◎	△	△	×	○	×
Methyl alcohol	◎	×	△	×	○	×
Acetone	◎	×	×	×	△	×
Toluene	◎	△	×	×	△	×
Benzene	◎	△	△	×	△	×

Note: Results depend on concentration.

× = bad
 △ = good
 ○ = better
 ◎ = best

Specifications

Through-beam Fiber Units

Type	Sensing direction	Appearance (mm)	Bending radius of cable (mm)	Sensing distance (mm)				Optical axis diameter (minimum sensing object)	Models	Page 39 Dimensions No.	
				E3X-HD		E3NX-FA					
				GIGA	HS	GIGA	HS				
Oil-resistant	Right-angle		Flexible*, R1	4,000 *1	*1	4,000 *1	*1	4 dia. (0.1 dia./0.03 dia.)	E32-T11NF 2M	39-A	
				Other modes	ST : 4,000	Other modes	ST : 4,000				
Chemical/oil resistant	Top-view		R40	4,000 *1	*1	4,000 *1	*1		E32-T12F 2M	39-B	
				Other modes	ST : 4,000	Other modes	ST : 4,000				
	Side-view		R4	4,000 *1	*1	4,000 *1	*1				E32-T11F 2M
				Other modes	SHS: 2,200	Other modes	SHS: 2,200				
Chemical/oil resistant 150°C *2	Top-view		R40	1,400	ST : 800	2,100	ST : 1,200	E32-T14F 2M	39-D		
				Other modes	SHS: 200	Other modes	SHS: 200				
Chemical/oil resistant 150°C *2	Top-view		R40	4,000 *1	*1	4,000 *1	*1	E32-T51F 2M	39-E		
				Other modes	ST : 2,800	Other modes	ST : 4,000				

*1 The optical fiber is 2 m long on each side, so the sensing distance is 4,000 mm.
 *2 For continuous operation, use the Fiber Unit between -40 and 130°C.

Reflective Fiber Units

Type	Sensing direction	Appearance (mm)	Bending radius of cable (mm)	Sensing distance (mm)				Standard sensing object (minimum sensing object)	Models	Page 39 Dimensions No.
				E3X-HD		E3NX-FA				
				GIGA	HS	GIGA	HS			
Semiconductors: Cleaning, developing, and etching, 60°C	Top-view		R40	8 to 20 mm from tip of lens (Recommended sensing distance: 11 mm) 19 to 31 mm from center of mounting hole A (Recommended sensing distance: 22 mm)				Glass (t=0.7 mm)	E32-L11FP 2M	39-F
Semiconductors: Resist stripping, 85°C				8 to 20 mm from tip of lens (Recommended sensing distance: 11 mm) 32 to 44 mm from center of mounting hole A (Recommended sensing distance: 35 mm)						
Chemical/oil resistant				GIGA -	ST : 190	GIGA -	ST : 280	E32-D12F 2M	39-H	
Only cable: chemical resistant				130	SHS: 60	190	SHS: 60			E32-D11U 2M

* For a definition, see page 90.

Note 1. The following mode names and response times apply to the modes given in the Sensing distance column.
 [E3X-HD] GIGA: Giga-power mode (16 ms), HS: High-speed mode (250 μs), ST: Standard mode (1 ms), and SHS: Super-high-speed mode (NPN output: 50 μs, PNP output: 55 μs)
 [E3NX-FA] GIGA: Giga-power mode (16 ms), HS: High-speed mode (250 μs), ST: Standard mode (1 ms), and SHS: Super-high-speed mode (30 μs)
2. The values for the minimum sensing object are reference values that indicate values obtained in standard mode with the sensing distance and sensitivity set to the optimum values. The first value is for the E3X-HD and the second value is for the E3NX-FA.
3. The sensing distances for Reflective Fiber Units are for white paper.

Through-beam Fiber Units (Set of 2)

39-A E32-T11NF 2M (Free Cutting)

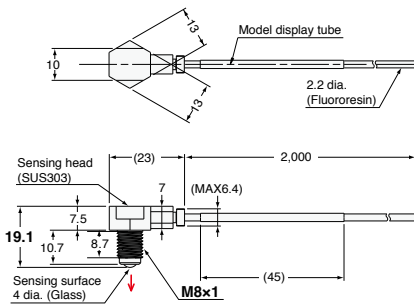

39-B E32-T12F 2M (Free Cutting)

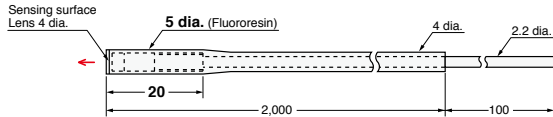

39-C E32-T11F 2M (Free Cutting)

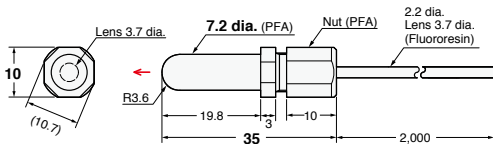

39-D E32-T14F 2M (Free Cutting)

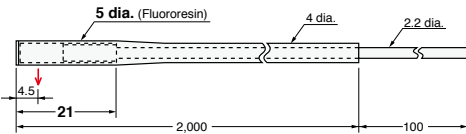

39-E E32-T51F 2M (Free Cutting)

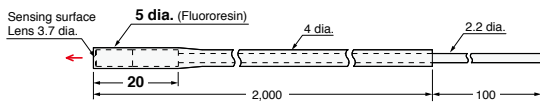

Reflective Fiber Units

39-F E32-L11FP 2M (Free Cutting)

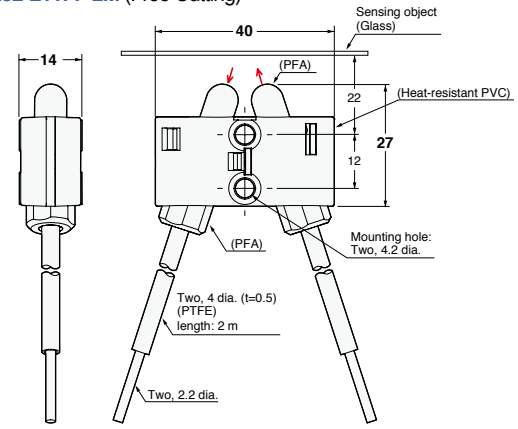

39-G E32-L11FS 2M (Free Cutting)

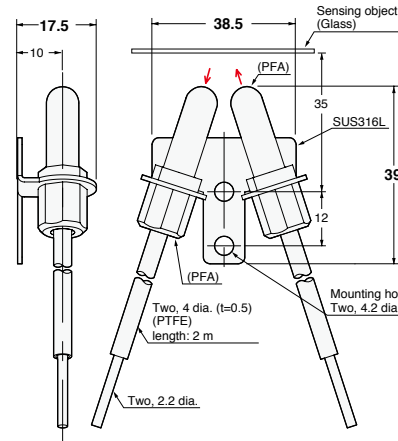

39-H E32-D12F 2M (Free Cutting)

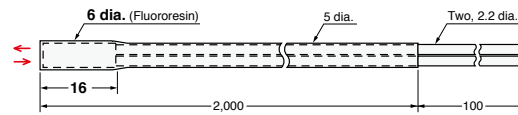

39-I E32-D11U 2M (Free Cutting)

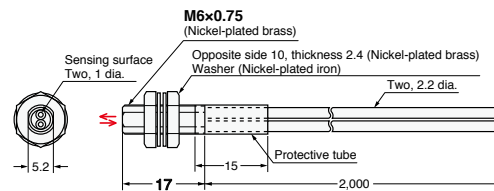

Fiber Sensing Features

Selection Guide

Fiber Units

Threaded

Cylindrical

Flat

Sleeved

Small Spot

High Power

Narrow view

BGS

Retro-reflective

Limited-reflective

Chemical-resistant, Oil-resistant

Bending

Heat-resistant

Area Detection

Liquid-level

Vacuum

FPD, Semi, Solar

Installation Information

Fiber Amplifiers, Communications Unit, and Accessories

Technical Guide and Precautions

Model Index

- Reference Information for Model Selection -

Oil-resistance performance of the E32-T11NF

This diagram explains why the new E32-T11NF is oil resistant.

Vacuum resin filling to prevent oils from entering.

IP68g protection (See. Note)

A fluororesin cable prevents water or oils from entering.

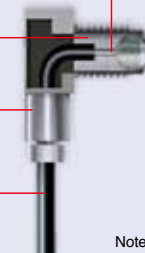

No danger of shorting since no electrical circuits are used.

Note: Equivalent to IP68g of JIS C0920 Annex 1.



- Capable of withstanding one million repeated bends.

Degree of bend: $\pm 180^\circ$
 Bending radius: 4 mm
 Weight: 50 g
 Bending rate: 30 times/minute

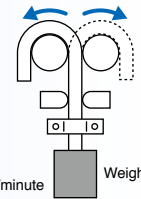

- A large number of independent fine fibers ensures good flexibility. Suitable for use on moving parts without easily breaking.

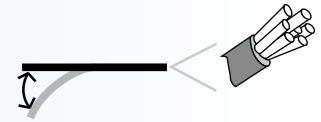

- Protective Stainless Spiral Tube is available for covering the fiber cable to protect it from accidental breaking due to snagging or shock.

Specifications

Through-beam Fiber Units

Size	Appearance (mm)	Bending radius of cable (mm)	Sensing distance (mm)						Optical axis diameter (minimum sensing object)	Models	Page 41 Dimensions No.
			E3X-HD			E3NX-FA					
			GIGA	HS	Other modes	GIGA	HS	Other modes			
1.5 dia.		Bend-resistant*, R4	680		ST : 400	1,020		0.5 dia. (5 μ m dia./ 2 μ m dia.)	E32-T22B 2M	41-A	
	220			SHS: 90	330		SHS: 90		E32-T21 2M	41-B	
M3			2,500		ST : 1,350	3,750		1 dia. (5 μ m dia./ 2 μ m dia.)	E32-T11 2M	41-C	
	900			SHS: 360	1,350		SHS: 360				
M4		500		ST : 300	750		0.5 dia. (5 μ m dia./ 2 μ m dia.)	E32-T25XB 2M	41-D		
	170		SHS: 70	250		SHS: 70					
Square											

* Bend-resistant fibers are for repeated bending applications, whereas Flexible fibers are meant for routing around tight corners.

Note 1. The following mode names and response times apply to the modes given in the Sensing distance column.

[E3X-HD] GIGA: Giga-power mode (16 ms), HS: High-speed mode (250 μ s), ST: Standard mode (1 ms), and SHS: Super-high-speed mode (NPN output: 50 μ s, PNP output: 55 μ s)

[E3NX-FA] GIGA: Giga-power mode (16 ms), HS: High-speed mode (250 μ s), ST: Standard mode (1 ms), and SHS: Super-high-speed mode (30 μ s)

2. The values for the minimum sensing object are reference values that indicate values obtained in standard mode with the sensing distance and sensitivity set to the optimum values. The first value is for the E3X-HD and the second value is for the E3NX-FA.

Protective Stainless Spiral Tube (Sold separately)

Insert the fiber cable into the protective tube to prevent breaking by snagging or shock.

Applicable Fiber Units	Model	Quantity	Page 41 Dimensions No.
E32-T11R 2M/E32-T11 2M/ E32-LT11 2M/E32-LT11R 2M/ E32-T51R 2M/E32-T51 2M	E39-F32C	2 pieces	41-E

* This Tube cannot be used if a Lens Unit is being used.

Threaded

Cylindrical

Flat

Sleeved

Small Spot

High Power

Narrow view

BGS

Retro-reflective

Limited-reflective

Chemical-resistant,
Oil-resistant

Bending

Heat-resistant

Area Detection

Liquid-level

Vacuum

FPD,
Semi,
Solar

Through-beam Fiber Units (Set of 2)

41-A E32-T22B 2M (Free Cutting)

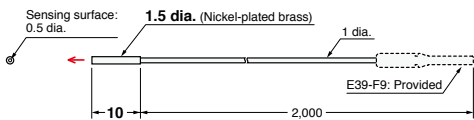

41-B E32-T21 2M (Free Cutting)

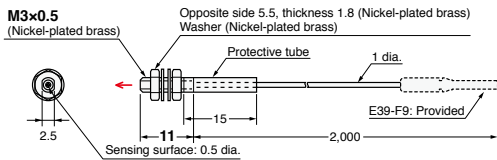

41-C E32-T11 2M (Free Cutting)

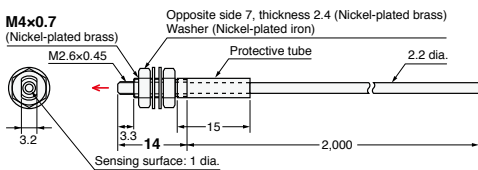

41-D E32-T25XB 2M (Free Cutting)

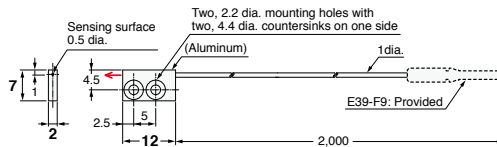

Note 1: Set of two symmetrically shaped Fiber Units.
 Note 2: Four, M2 x 8 stainless steel countersunk mounting screws are provided.

41-E E39-F32C

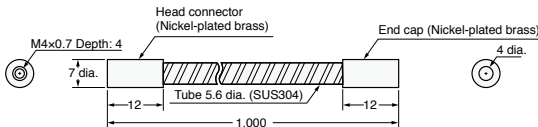

Fiber Sensing Features	
Selection Guide	
Fiber Units	
Threaded	Standard Installation
Cylindrical	
Flat	Saving Space
Sleeved	
Small Spot	Beam Improvements
High Power	
Narrow view	
BGS	
Retro-reflective	Transparent Objects
Limited-reflective	
Chemical-resistant, Oil-resistant	Environmental Immunity
Bending	
Heat-resistant	
Area Detection	Applications
Liquid-level	
Vacuum	
FPD, Semi, Solar	
Installation Information	
Fiber Amplifiers, Communications Unit, and Accessories	
Technical Guide and Precautions	
Model Index	



- Capable of withstanding one million repeated bends.

Degree of bend: $\pm 180^\circ$
 Bending radius: 4 mm
 Weight: 50 g
 Bending rate: 30 times/minute

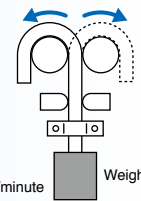

- A large number of independent fine fibers ensures good flexibility. Suitable for use on moving parts without easily breaking.

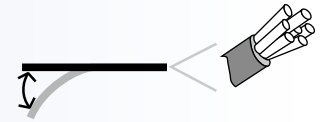

- Protective Stainless Spiral Tube is available for covering the fiber cable to protect it from accidental breaking due to snagging or shock.

Specifications



Reflective Fiber Units

Size	Appearance (mm)	Bending radius of cable (mm)	Sensing distance (mm)				Optical axis diameter (minimum sensing object)	Models	Page 43 Dimensions No.
			E3X-HD		E3NX-FA				
			GIGA	HS	Other modes	GIGA			
1.5 dia.		Bend-resistant*, R4	140		ST : 60	210	ST : 90	E32-D22B 2M	43-A
M3			40		SHS: 16	60	SHS: 16	E32-D21 2M	43-B
3 dia.			300		ST : 140	450	ST : 210	E32-D221B 2M	43-C
M4			90		SHS: 40	130	SHS: 40	E32-D21B 2M	43-D
M6			840		ST : 350	1,260	ST : 520	E32-D11 2M	43-E
Square			240		ST : 100	360	ST : 150	E32-D25XB 2M	43-F
			240		SHS: 100	360	SHS: 100		
		240		SHS: 30	90	SHS: 30			

* Bend-resistant fibers are for repeated bending applications, whereas Flexible fibers are meant for routing around tight corners.

Note 1. The following mode names and response times apply to the modes given in the Sensing distance column.

[E3X-HD] GIGA: Giga-power mode (16 ms), HS: High-speed mode (250 μ s), ST: Standard mode (1 ms), and SHS: Super-high-speed mode (NPN output: 50 μ s, PNP output: 55 μ s)

[E3NX-FA] GIGA: Giga-power mode (16 ms), HS: High-speed mode (250 μ s), ST: Standard mode (1 ms), and SHS: Super-high-speed mode (30 μ s)

2. The values for the minimum sensing object are reference values that indicate values obtained in standard mode with the sensing distance and sensitivity set to the optimum values.

The first value is for the E3X-HD and the second value is for the E3NX-FA.

3. The sensing distances for Reflective Fiber Units are for white paper.

Protective Stainless Spiral Tube (Sold separately)

Insert the fiber cable into the protective tube to prevent breaking by snagging or shock.

Applicable Fiber Units	Models	Quantity	Page 43 Dimensions No.
E32-D21R 2M/E32-C31 2M/ E32-D21 2M	E39-F32A	1 piece	43-G
E32-D211R 2M/E32-D21B 2M	E39-F32C	2 pieces	
E32-D11R 2M/E32-CC200 2M/ E32-D11 2M/E32-D51R 2M/ E32-D51 2M	E39-F32D	1 piece	

* This Tube cannot be used if a Lens Unit is being used.

Reflective Fiber Units

43-A E32-D22B 2M (No Cutting)

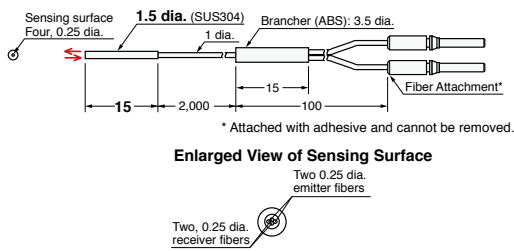

43-B E32-D21 2M (Free Cutting)

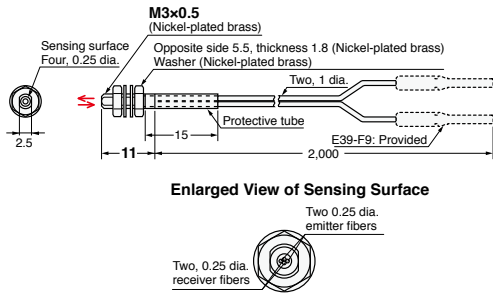

43-C E32-D221B 2M (Free Cutting)

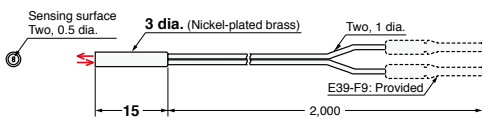

43-D E32-D21B 2M (Free Cutting)

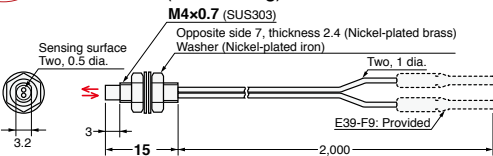

43-E E32-D11 2M (Free Cutting)

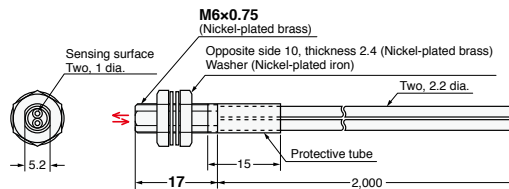

43-F E32-D25XB 2M (Free Cutting)

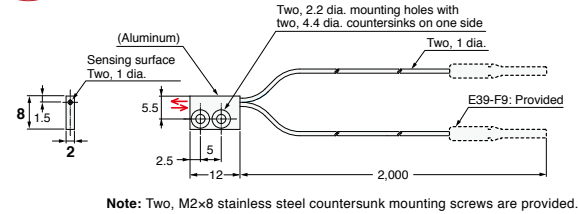

43-G E39-F32A/E39-F32C/E39-F32D

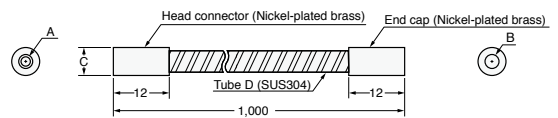

Models	A	B	C	D
E39-F32A	M3x0.5 Depth: 4	3 dia.	6 dia.	(4.6 dia.)
E39-F32C	M4x0.7 Depth: 4	4 dia.	7 dia.	(5.6 dia.)
E39-F32D	M6x0.75 Depth: 4	5 dia.	8.5 dia.	(7 dia.)

Fiber Sensing Features	
Selection Guide	
Fiber Units	
Threaded	Standard Installation
Cylindrical	
Flat	Saving Space
Sleeved	
Small Spot	Beam Improvements
High Power	
Narrow view	
BGS	
Retro-reflective	Transparent Objects
Limited-reflective	
Chemical-resistant, Oil-resistant	Environmental Immunity
Bending	
Heat-resistant	
Area Detection	Applications
Liquid-level	
Vacuum	
FPD, Semi, Solar	
Installation Information	
Fiber Amplifiers, Communications Unit, and Accessories	
Technical Guide and Precautions	
Model Index	

Threaded

Cylindrical

Flat

Sleeved

Small Spot

High Power

Narrow view

BGS

Retro-reflective

Limited-reflective

Chemical-resistant,
Oil-resistant

Bending

Area
Detection

Liquid-level

Vacuum

- Wide product variety for temperatures from 100 to 350°C.
Select the model according to heat-resistant temperature.

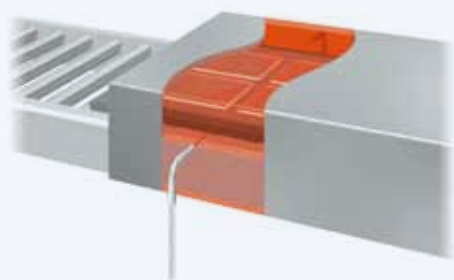

Specifications

Through-beam Fiber Units

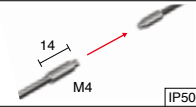
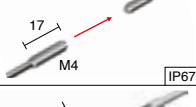
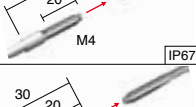
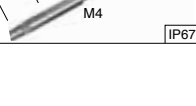
Heat-resistant temperature	Appearance (mm)	Bending radius of cable (mm)	Sensing distance (mm)				Optical axis diameter (minimum sensing object)	Models	Page 45 Dimensions No.
			E3X-HD		E3NX-FA				
			GIGA	HS	GIGA	HS			
100°C *1		Flexible*, R2	1,600	ST : 800	2,400	ST : 1,200	1 dia. (0.1 dia./0.03 dia.)	E32-T51R 2M	45-A
			560	SHS: 225	840	SHS: 225			
150°C *2		R35	2,800	ST : 1,500	4,000*5	ST : 2,250	1.5 dia. (0.1 dia./0.03 dia.)	E32-T51 2M	45-B
			1,000	SHS: 400	1,500	SHS: 400			
200°C *3		R10	1,000	ST : 550	1,500	ST : 820	0.7 dia. (5 μm dia./2 μm dia.)	E32-T81R-S 2M	45-C
			360	SHS: 140	540	SHS: 140			
350°C *4		R25	1,680	ST : 900	2,520	ST : 1,350	1 dia. (5 μm dia./2 μm dia.)	E32-T61-S 2M	45-D
			600	SHS: 240	900	SHS: 240			
70°C			—					Standard Fiber Units can be used.	—

* For a definition, see page 90.

*1 For continuous operation, use the Fiber Unit between -40 to 90°C.

*2 For continuous operation, use the Fiber Unit between -40 to 130°C.

*3 The heat-resistant rating is not the same for all parts of the Fiber Unit. Refer to the dimensions diagrams for details.

*4 The ambient operating temperature for the E32-T61-S 2M is -60 to 350°C.

*5 The optical fiber is 2 m long on each side, so the sensing distance is 4,000 mm.

Note 1. The following mode names and response times apply to the modes given in the Sensing distance column.

[E3X-HD] GIGA: Giga-power mode (16 ms), HS: High-speed mode (250 μs), ST: Standard mode (1 ms), and SHS: Super-high-speed mode (NPN output: 50 μs, PNP output: 55 μs)

[E3NX-FA] GIGA: Giga-power mode (16 ms), HS: High-speed mode (250 μs), ST: Standard mode (1 ms), and SHS: Super-high-speed mode (30 μs)

2. The values for the minimum sensing object are reference values that indicate values obtained in standard mode with the sensing distance and sensitivity set to the optimum values. The first value is for the E3X-HD and the second value is for the E3NX-FA.

Through-beam Fiber Units (Set of 2)

45-A E32-T51R 2M (Free Cutting)

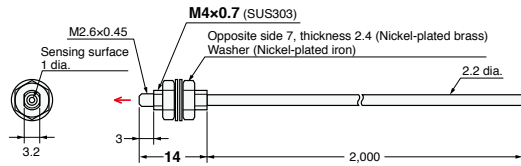

45-B E32-T51 2M (Free Cutting)

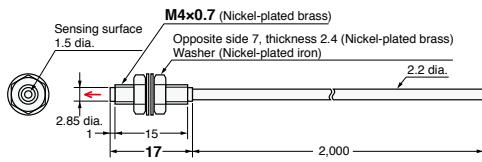

45-C E32-T81R-S 2M (No Cutting)

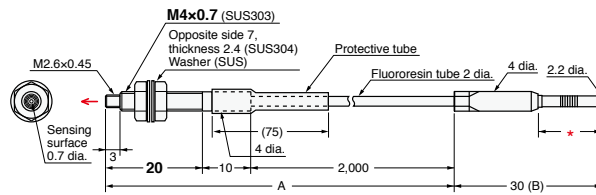

Note: The maximum allowable temperatures for sections A and B are 200°C and 110°C, respectively. The section inserted into the Amplifier Unit (indicated by *) must be maintained within the Amplifier Unit's operating temperature range.

45-D E32-T61-S 2M (No Cutting)

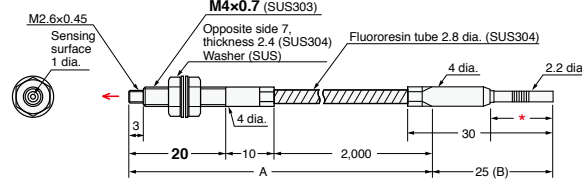

Note: The maximum allowable temperatures for sections A and B are 350°C and 110°C, respectively. The section inserted into the Amplifier Unit (indicated by *) must be maintained within the Amplifier Unit's operating temperature range.

- Reference Information for Model Selection -

Long-distance Sensing Applications

A separate Lens Unit can be attached to extend the sensing distance.

→ Page 28

Fiber Sensing Features	
Selection Guide	
Fiber Units	
Threaded	Standard Installation
Cylindrical	
Flat	Saving Space
Sleeved	
Small Spot	Beam Improvements
High Power	
Narrow view	
BGS	
Retro-reflective	Transparent Objects
Limited-reflective	
Chemical-resistant, Oil-resistant	Environmental Immunity
Bending	
Heat-resistant	
Area Detection	Applications
Liquid-level	
Vacuum	
FPD, Semi, Solar	
Installation Information	
Fiber Amplifiers, Communications Unit, and Accessories	
Technical Guide and Precautions	
Model Index	

Threaded

Cylindrical

Flat

Sleeved

Small Spot

High Power

Narrow view

BGS

Retro-reflective

Limited-reflective

Chemical-resistant,
Oil-resistant

Bending

Heat-resistant

Area Detection

Liquid-level

Vacuum

FPD,
Semi,
Solar

- Wide product variety for temperatures from 100 to 400°C.
Select the model according to heat-resistant temperature.

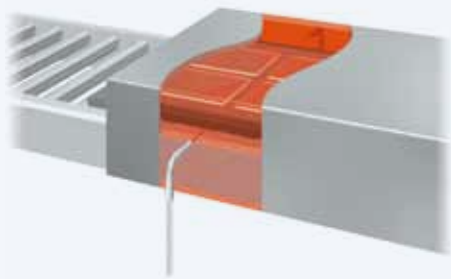

Specifications

Reflective Fiber Units										
Heat-resistant temperature	Appearance (mm)	Bending radius of cable (mm)	Sensing distance (mm)				Standard sensing object (minimum sensing object)	Models	Page 47 Dimensions No.	
			E3X-HD		E3NX-FA					
			GIGA	HS	Other modes	GIGA				HS
100°C *1		Flexible*, R2	670	ST : 280	1,000	ST : 420	(5 μm dia./ 2 μm dia.)	E32-D51R 2M	47-A	
			190	SHS: 80	280	SHS: 80				
			1,120	ST : 450	1,680	ST : 670				
150□ *2		R35	320	SHS: 144	480	SHS: 144	(5 μm dia./ 2 μm dia.)	E32-D51 2M	47-B	
200□ *3		R10	420	ST : 180	630	ST : 270			E32-D61R-S 2M	47-C
			120	SHS: 54	180	SHS: 54				
300□		R25	10 to 20	ST : 10 to 20	10 to 20	ST : 10 to 20	Soda glass with reflection factor of 7%	E32-A08H2 2M	47-D	
			20 to 30	ST : 20 to 30	20 to 30	ST : 20 to 30		End surface of soda glass with reflection factor of 7% (t = 0.7 mm, rounded edges)	E32-A09H2 2M	47-E
350□ *3		R25	420	ST : 180	630	ST : 270	(5 μm dia./ 2 μm dia.)	E32-D611-S 2M	47-F	
			120	SHS: 54	180	SHS: 54			E32-D61-S 2M	47-G
400□ *3			280	ST : 120	420	ST : 180			E32-D73-S 2M	47-H
			80	SHS: 36	120	SHS: 36				
70□			—					Standard Fiber Units can be used.	—	

* For a definition, see page 90.

*1 For continuous operation, use the Fiber Unit between -40 to 90°C.

*2 For continuous operation, use the Fiber Unit between -40 to 130°C.

*3 The heat-resistant rating is not the same for all parts of the Fiber Unit. Refer to the dimensions diagrams for details.

Note 1. The following mode names and response times apply to the modes given in the Sensing distance column.

[E3X-HD] GIGA: Giga-power mode (16 ms), HS: High-speed mode (250 μs), ST: Standard mode (1 ms), and SHS: Super-high-speed mode (NPN output: 50 μs, PNP output: 55 μs)
[E3NX-FA] GIGA: Giga-power mode (16 ms), HS: High-speed mode (250 μs), ST: Standard mode (1 ms), and SHS: Super-high-speed mode (30 μs)

2. The values for the minimum sensing object are reference values that indicate values obtained in standard mode with the sensing distance and sensitivity set to the optimum values.

The first value is for the E3X-HD and the second value is for the E3NX-FA.

3. The sensing distances for Reflective Fiber Units are for white paper.

Reflective Fiber Units

47-A E32-D51R 2M (Free Cutting)

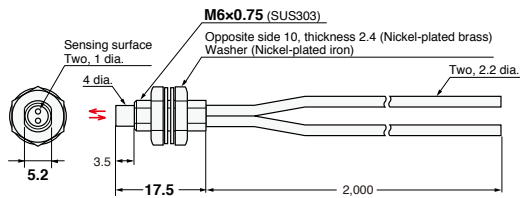

47-B E32-D51 2M (Free Cutting)

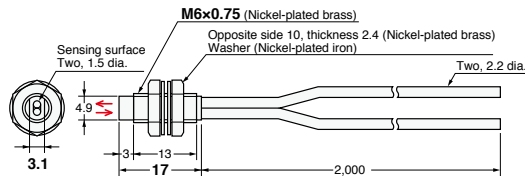

47-C E32-D81R-S 2M (No Cutting)

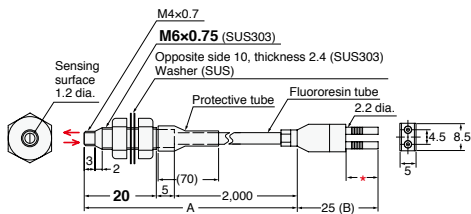

Note: The maximum allowable temperatures for sections A and B are 200°C and 110°C, respectively. The section inserted into the Amplifier Unit (indicated by *) must be maintained within the Amplifier Unit's operating temperature range.

47-D E32-A08H2 2M (No Cutting)

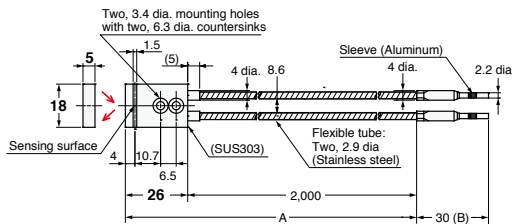

Note: The maximum allowable temperatures for sections A and B are 300°C and 110°C, respectively.

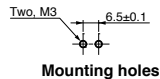

47-E E32-A09H2 2M (No Cutting)

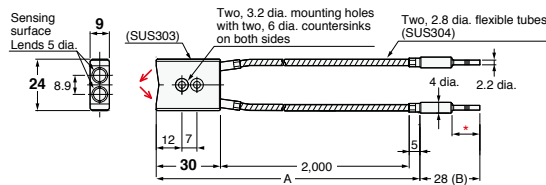

Note: The maximum allowable temperatures for sections A and B are 300°C and 110°C, respectively. The section inserted into the Amplifier Unit (indicated by *) must be maintained within the Amplifier Unit's operating temperature range.

47-F E32-D611-S 2M (No Cutting)

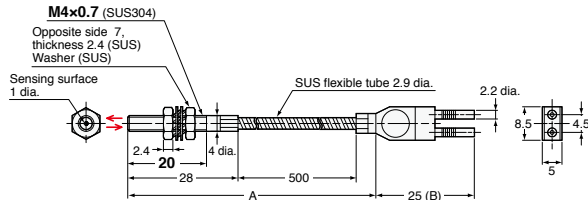

Note: The maximum allowable temperatures for sections A and B are 300°C and 110°C, respectively.

47-G E32-D61-S 2M (No Cutting)

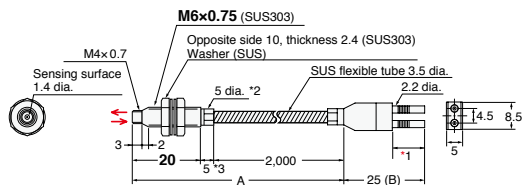

- *2. The diameter is 6 dia. if the fiber length exceeds 10 m.
- *3. The length is 10 if the fiber length exceeds 10 m.

Note: The maximum allowable temperatures for sections A and B are 350°C and 110°C, respectively. The section inserted into the Amplifier Unit (indicated by *) must be maintained within the Amplifier Unit's operating temperature range.

47-H E32-D73-S 2M (No Cutting)

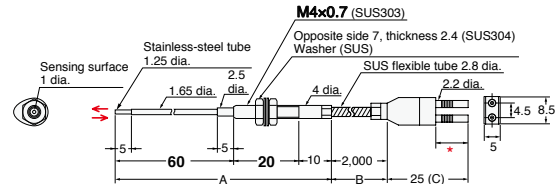

Note: The maximum allowable temperatures for sections A, B, and C are 400°C, 300°C, and 110°C, respectively. The section inserted into the Amplifier Unit (indicated by *) must be maintained within the Amplifier Unit's operating temperature range.

Fiber Sensing Features	
Selection Guide	
Fiber Units	
Threaded	Standard Installation
Cylindrical	
Flat	Saving Space
Sleeved	
Small Spot	Beam Improvements
High Power	
Narrow view	
BGS	
Retro-reflective	Transparent Objects
Limited-reflective	
Chemical-resistant, Oil-resistant	Environmental Immunity
Bending	
Heat-resistant	
Area Detection	Applications
Liquid-level	
Vacuum	
FPD, Semi, Solar	
Installation Information	
Fiber Amplifiers, Communications Unit, and Accessories	
Technical Guide and Precautions	
Model Index	

Threaded
Cylindrical

Flat
Sleeved

Small Spot
High Power
Narrow view
BGS

Retro-reflective
Limited-reflective

Chemical-resistant, Oil-resistant
Bending
Heat-resistant

Area Detection
Liquid-level
Vacuum
FPD, Semi, Solar

Detection of falling workpieces

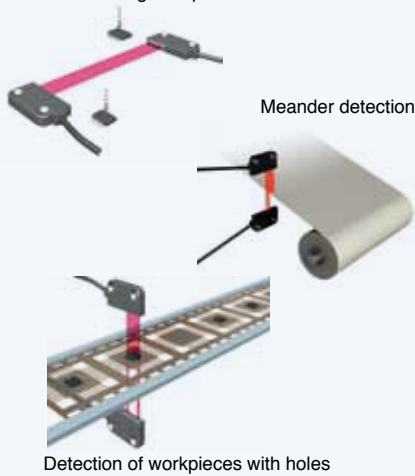

• Area beams are optimum for detecting workpieces presented in inconsistent positions, such as falling workpieces, or for meander detection, or for detecting workpieces with holes.

• This Fiber Unit is ideal for meander detection because it outputs the digital value in a linear relation to the interrupted light distance.

Characteristics of Light Interruption (Reference Value)

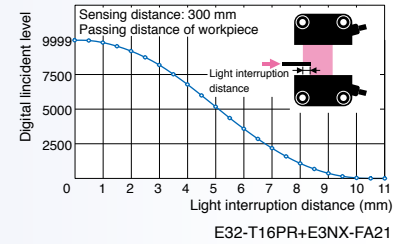

Specifications

Through-beam Fiber Units

Type	Sensing width	Appearance (mm)	Bending radius of cable (mm)	Sensing distance (mm)				Optical axis diameter (minimum sensing object)	Models	Page 49 Dimensions No.
				E3X-HD		E3NX-FA				
				GIGA	HS	Other modes	GIGA			
Area	11 mm		Flexible*, R1	3,100	ST : 1,700	4,000 *1	ST : 2,550	*2 (0.2 dia./ 0.07 dia.)	E32-T16PR 2M	49-A
				1,120	SHS: 440	1,680	SHS: 440			
	30 mm		2,750	ST : 1,500	4,000 *1	ST : 2,250	*2 (0.3 dia./ 0.1 dia.)		E32-T16JR 2M	49-B
960			SHS: 380	1,440	SHS: 380					
				4,000 *1	ST : 2,600	4,000 *1	ST : 3,900	E32-T16WR 2M	49-C	
				1,700	SHS: 680	2,550	SHS: 680			

* For a definition, see page 90.

*1 The optical fiber is 2 m long on each side, so the sensing distance is 4,000 mm.

*2 The values for the minimum sensing object were obtained for detection in the sensing area with the sensing distance set to 300 mm. (The values are for a stationary sensing object.)
The first value is for the E3X-HD and the second value is for the E3NX-FA.

Reflective Fiber Units

Type	Sensing width	Appearance (mm)	Bending radius of cable (mm)	Sensing distance (mm)				Optical axis diameter (minimum sensing object)	Model	Page 49 Dimensions No.
				E3X-HD		E3NX-FA				
				GIGA	HS	Other modes	GIGA			
Array	11 mm		Bend-resistant*, R4	700	ST : 300	1,050	ST : 450	(5 μm dia./ 2 μm dia.)	E32-D36P1 2M	49-D
				200	SHS: 90	300	SHS: 90			

* Bend-resistant fibers are for repeated bending applications, whereas Flexible fibers are meant for routing around tight corners.

Note 1. The following mode names and response times apply to the modes given in the Sensing distance column.

[E3X-HD] GIGA: Giga-power mode (16 ms), HS: High-speed mode (250 μs), ST: Standard mode (1 ms), and SHS: Super-high-speed mode (NPN output: 50 μs, PNP output: 55 μs)
[E3NX-FA] GIGA: Giga-power mode (16 ms), HS: High-speed mode (250 μs), ST: Standard mode (1 ms), and SHS: Super-high-speed mode (30 μs)

2. The values for the minimum sensing object are reference values that indicate values obtained in standard mode with the sensing distance and sensitivity set to the optimum values. The first value is for the E3X-HD and the second value is for the E3NX-FA.

Through-beam Fiber Units (Set of 2)

49-A E32-T16PR 2M (Free Cutting)

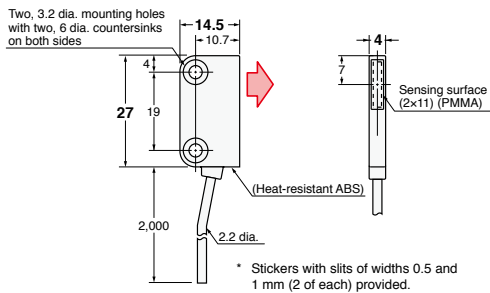

49-B E32-T16JR 2M (Free Cutting)

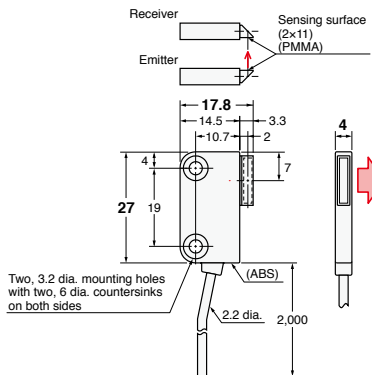

49-C E32-T16WR 2M (Free Cutting)

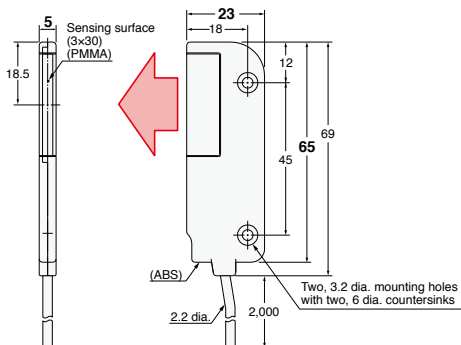

Through-beam Fiber Units (Set of 2)

49-D E32-D36P1 2M (Free Cutting)

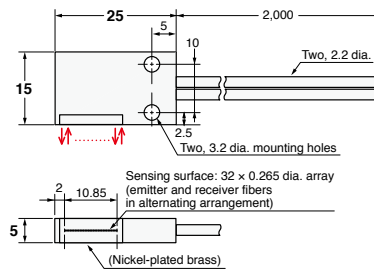

Fiber Sensing Features

Selection Guide

Fiber Units

Threaded

Standard Installation

Cylindrical

Saving Space

Flat

Sleeved

Beam Improvements

Small Spot

High Power

Narrow view

BGS

Transparent Objects

Retro-reflective

Limited-reflective

Environmental Immunity

Chemical-resistant, Oil-resistant

Bending

Heat-resistant

Area Detection

Applications

Liquid-level

Vacuum

FPD, Semi, Solar

Installation Information

Fiber Amplifiers, Communications Unit, and Accessories

Technical Guide and Precautions

Model Index

Threaded

Cylindrical

Flat

Sleeved

Small Spot

High Power

Narrow view

BGS

Retro-reflective

Limited-reflective

Chemical-resistant,
Oil-resistant

Bending

Heat-resistant

Area
Detection

Liquid-level

Vacuum

FPD,
Semi,
Solar

- Fiber Units for detecting liquid levels are available in two types: for tube mounting and liquid contact.

▶ Tube-mounting Types

Detect the liquid level inside transparent tubes. Strap the Fiber Unit to a tube with band.



▶ Liquid-contact Type

Detect the liquid level by direct contact with the liquid. This model has excellent chemical-resistance because the Fiber Unit is covered in fluororesin.

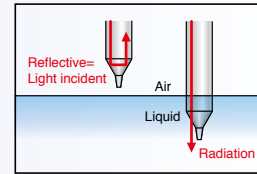

Specifications

Detection scheme	Tube diameter	Features	Appearance (mm)	Bending radius of cable (mm)	Applicable range	Optical axis diameter (minimum sensing object)	Models	Page 51 Dimensions No.
Tube-mounting	3.2, 6.4 and 9.5 dia.	<ul style="list-style-type: none"> Resistant to bubbles and droplets Residual quantity detection 	 IP50	Bend-resistant*, R4	Applicable tube: Transparent tube with a diameter of 3.2, 6.4, or 9.5 dia. and a recommended wall thickness of 1 mm	—	E32-A01 5M	51-A
	8 to 10 dia.	Ideal for mounting at multilevels	 IP50	R10	Applicable tube: Transparent tube with a diameter of 8 to 10 dia. and a recommended wall thickness of 1 mm	—	E32-L25T 2M	51-B
	No restrictions	<ul style="list-style-type: none"> Usable on large diameter tubes Resistant to bubbles and droplets 	 IP67	R4	Applicable tube: Transparent tube (no restrictions on diameter)	—	E32-D36T 2M	51-C
Liquid contact (heat-resistant up to 200°C)	—	—	 IP68	R40 R25 *3	Liquid-contact Type *1	—	E32-D82F1 4M	51-D

* Bend-resistant fibers are for repeated bending applications, whereas Flexible fibers are meant for routing around tight corners.

*1 If the incident light level is too high, perform power tuning or use the ECO mode to decrease the incident level.

*2 The applicable range is the same whether an E3X-HD series or E3NX-FA series is used.

When using a Fiber Amplifier Unit in giga-power mode, level detection may not work depending on the tube diameter. Make sure to confirm operation with the actual tube.

*3 The bending radius of the sensing section (except for the unbendable section) is 40 mm, and the bending radius of the fiber is 25 mm.

- Reference Information for Model Selection -

Determining the Best Model for Tube-mounted Types

Mounting and conditions	Recommended Unit	Features
When bubbles and the water droplets are generated	E32-A01	<p>This is a Through-beam Model, so the incident light will differ greatly between with and without of liquid. It also uses an area beam, which is less prone to false detection by bubbles and droplets.</p>
Multilevel installation in limited space	E32-L25T	<p>This model is suitable for mounting at multilevels because of the thin type (height: 10 mm).</p>
Mounting on large diameter tubes	E32-D36T	<p>This model has no restrictions on the tube diameter, so it can be mounted on many different tube sizes. It also uses an area beam, which is less prone to false detection by bubbles and droplets.</p>

51-A E32-A01 5M (Free Cutting)

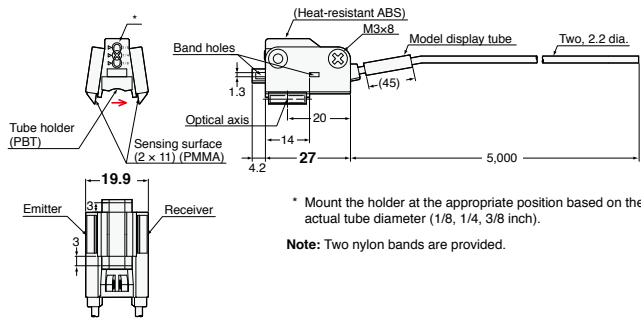

Tube-mounting Examples



51-B E32-L25T 2M (Free Cutting)

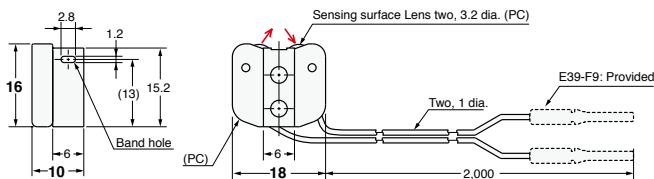

51-C E32-D36T 2M (Free Cutting)

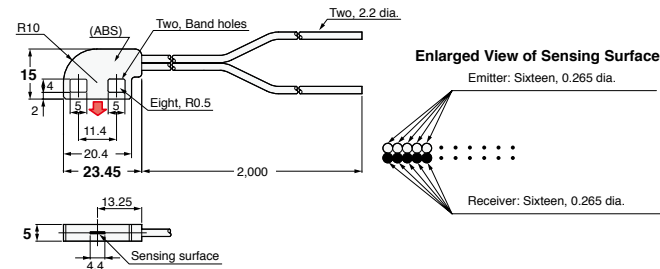

51-D E32-D82F1 4M (Free Cutting)

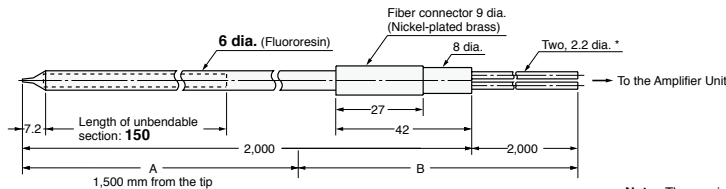

Note: The maximum allowable temperature is 200°C for section A and 85°C for section B.

And

Designed for Safe Residual quantity detection (E32-A01 only)

The E32-A01 Fiber Unit is designed to default to the same output as for liquid absent in the event of a failure, such as when the fiber breaks. This makes it suitable for residual quantity detection.

Trouble (disconnection)	Light interrupted
Without liquid	Light interrupted
With liquid	Light incident

If the failure goes unnoticed, this failsafe design will prevent false detection of liquid when there is no liquid present.

Fiber Sensing Features	
Selection Guide	
Fiber Units	
Threaded	Standard Installation
Cylindrical	
Flat	Saving Space
Sleeved	
Small Spot	Beam Improvements
High Power	
Narrow view	
BGS	
Retro-reflective	Transparent Objects
Limited-reflective	
Chemical-resistant, Oil-resistant	Environmental Immunity
Bending	
Heat-resistant	
Area Detection	Applications
Liquid-level	
Vacuum	
FPD, Semi, Solar	
Installation Information	
Fiber Amplifiers, Communications Unit, and Accessories	
Technical Guide and Precautions	
Model Index	



- Can be used under high vacuums of up to 10^{-5} Pa.
- Available in models with heat resistant up to 120 or 200°C.

Configuration Example for using under vacuum

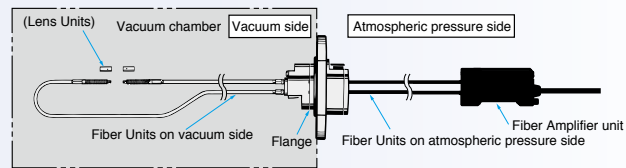

Specifications

Through-beam Fiber Units

Type	Heat-resistant temperature	Appearance (mm)	Bending radius of cable (mm)	Sensing distance (mm)						Optical axis diameter (minimum sensing object)	Models	Page 53 Dimensions No.
				E3X-HD			E3NX-FA					
				GIGA	HS	Other modes	GIGA	HS	Other modes			
Vacuum side	120□		R30	720	ST : 400	1,080	ST : 600	1.2 dia. (10 μm dia./ 4 μm dia.)	E32-T51V 1M	53-A		
				260	SHS: 100	390	SHS: 100					
Vacuum side	200□		R30	2,000*	ST : 2,000	2,000*	ST : 2,000	4 dia. (0.1 dia./ 0.03 dia.)	E32-T51V 1M + E39-F1V	53-B		
				1,360	SHS: 520	2,000*	SHS: 520					
Atmospheric pressure side	70□		R25	1,760	ST : 950	2,000*	ST : 1,420	2 dia. (0.1 dia./ 0.03 dia.)	E32-T84SV 1M	53-C		
				640	SHS: 260	960	SHS: 260					
Atmospheric pressure side	70□		R25	—	ST : -	—	ST : -	—	E32-T10V 2M	53-D		

* The optical fiber is 2 m long on each side, so the sensing distance is 4,000 mm.

Note 1. The following mode names and response times apply to the modes given in the Sensing distance column.

[E3X-HD] GIGA: Giga-power mode (16 ms), HS: High-speed mode (250 μs), ST: Standard mode (1 ms), and SHS: Super-high-speed mode (NPN output: 50 μs, PNP output: 55 μs)
[E3NX-FA] GIGA: Giga-power mode (16 ms), HS: High-speed mode (250 μs), ST: Standard mode (1 ms), and SHS: Super-high-speed mode (30 μs)

2. The values for the minimum sensing object are reference values that indicate values obtained in standard mode with the sensing distance and sensitivity set to the optimum values. The first value is for the E3X-HD and the second value is for the E3NX-FA.

Flange

Appearance	Type	Models	Page 53 Dimensions No.
	4-channel flange	E32-VF4	53-E
	1-channel flange	E32-VF1	53-F

Through-beam Fiber Units (Set of 2)

53-A E32-T51V 1M (No Cutting)

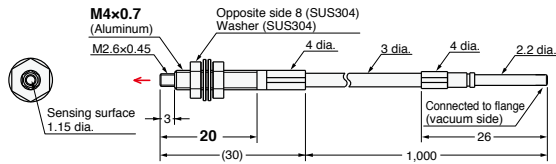

53-B E32-T51V 1M (No Cutting) + E39-F1V

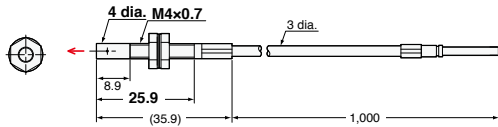

E39-F1V

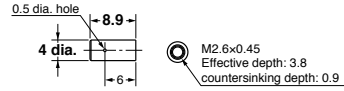

53-C E32-T84SV 1M (No Cutting)

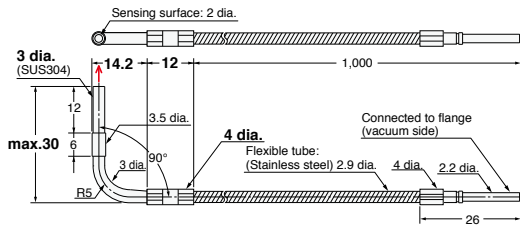

53-D E32-T10V 2M (Free Cutting)

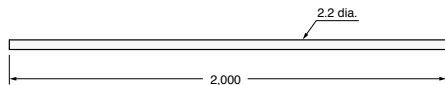

53-E E32-VF4

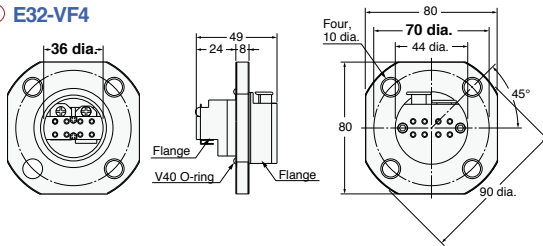

- Note 1.** Mount the Flange so that the V40 O-Ring is on the atmospheric-pressure side of the vacuum chamber wall.
Note 2. Mounting-hole dimensions: 38 dia. ±0.5 mm
Note 3. The maximum tightening torque is 9.8 N·m.

53-F E32-VF1

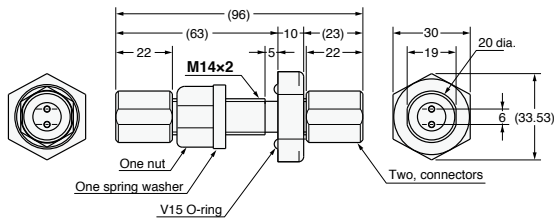

- Note 1.** Mount the Flange so that the V15 O-Ring is on the atmospheric-pressure side of the vacuum chamber wall.
Note 2. Mounting-hole dimensions: 14.5 dia. ±0.2 mm
Note 3. The maximum tightening torque is 14.7 N·m for the clamp nut and 1.5 N·m for the connector.

- Reference Information for Model Selection -

What Is a Vacuum-resistant Fiber Unit?

- The Flange is designed to create an air-tight seal on the vacuum side.
- The fibers and Flange on the vacuum side are made of non-outgassing materials. These parts are inspected, cleaned, and sealed in an air-tight package in a clean room prior to shipment.

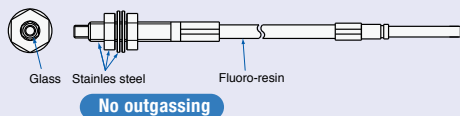

Threaded

Cylindrical

Flat

Sleeved

Small Spot

High Power

Narrow view

BGS

Retro-reflective

Limited-reflective

Chemical-resistant, Oil-resistant

Bending

Heat-resistant

Area Detection

Liquid-level

Vacuum

FPD, Semi, Solar

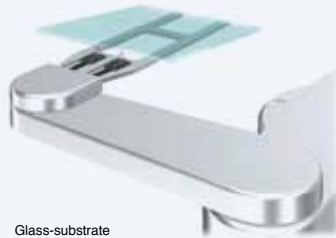

Glass-substrate Alignment

- ▶ Detection position accuracy: 0.2 mm max. No variation in detection positions even if the sensing distance changes.
- ▶ Tilting workpiece does not affect detection.

• Glass-substrate Mapping

Stable detection is possible even for difficult-to-detect curved surfaces.

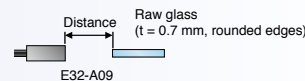
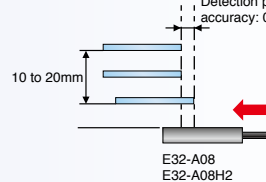
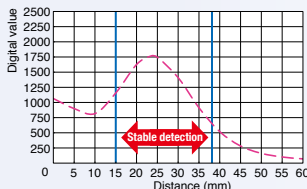

• Glass Presence Detection in Wet Processes

- ▶ Stable non-contact detection even with warped glass.
- ▶ The spherical heads ensure stable detection without being influenced by liquid.

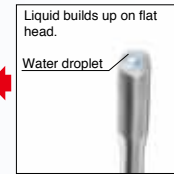
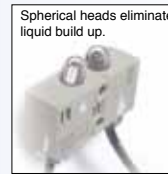

Specifications

Limited-reflective Fiber Units

Application	Ambient temperature	Appearance (mm)	Bending radius of cable (mm)	Sensing distance (mm)				Standard sensing object (minimum sensing object)	Models	Page 55 Dimensions No.	
				E3X-HD		E3NX-FA					
				GIGA	HS	GIGA	HS				
Glass presence detection	70□		R25	0 to 15	ST : 0 to 15	0 to 15	ST : 0 to 15	Soda glass with reflection factor of 7%	E32-L16-N 2M *1	55-A	
				0 to 15	SHS: 0 to 12	0 to 15	SHS: 0 to 12				
Glass-substrate Alignment	300□		R25	10 to 20	ST : 10 to 20	10 to 20	ST : 10 to 20		End surface of soda glass with reflection factor of 7% (t = 0.7 mm, rounded edges)	E32-A08 2M *1	55-B
				10 to 20	SHS: -	10 to 20	SHS: -				
	70□			12 to 30	ST : 12 to 30	12 to 30	ST : 12 to 30			E32-A08H2 2M *1	55-C
				12 to 30	SHS: -	12 to 30	SHS: -				
Mapping of glass substrates	300°C *2		R25	15 to 38	ST : 15 to 38	15 to 38	ST : 15 to 38		E32-A12 2M	55-D	
				15 to 38 (Center 25)	SHS: - (Center 25)	15 to 38 (Center 25)	SHS: - (Center 25)				
Wet processes (Cleaning, Resist developing, and etching)	60□		R40	8 to 20 mm from tip of lens (Recommended sensing distance: 11 mm)	-	8 to 20 mm from tip of lens (Recommended sensing distance: 11 mm)	-	Glass (t=0.7mm)	E32-A09 2M	55-E	
				19 to 31 mm from center of mounting hole A (Recommended sensing distance: 22 mm)		19 to 31 mm from center of mounting hole A (Recommended sensing distance: 22 mm)					
Wet processes (Resist stripping)	85□		R40	8 to 20 mm from tip of lens (Recommended sensing distance: 11 mm)	-	8 to 20 mm from tip of lens (Recommended sensing distance: 11 mm)	-	Glass (t=0.7mm)	E32-A09H2 2M	55-F	
				32 to 44 mm from center of mounting hole A (Recommended sensing distance: 35 mm)		32 to 44 mm from center of mounting hole A (Recommended sensing distance: 35 mm)					

*1 If operation is affected by the background, perform power tuning or use the ECO Mode to decrease the incident level.

*2 The maximum allowable temperature is not the same for all parts of the Fiber Unit. Refer to the dimensions diagrams for details. Must not be repeatedly subject to rapid temperature changes.

Note 1. The following mode names and response times apply to the modes given in the Sensing distance column.

[E3X-HD] GIGA: Giga-power mode (16 ms), HS: High-speed mode (250 μs), ST: Standard mode (1 ms), and SHS: Super-high-speed mode (NPN output: 50 μs, PNP output: 55 μs)
 [E3NX-FA] GIGA: Giga-power mode (16 ms), HS: High-speed mode (250 μs), ST: Standard mode (1 ms), and SHS: Super-high-speed mode (30 μs)

Limited-reflective Fiber Units

55-A E32-L16-N 2M (Free Cutting)

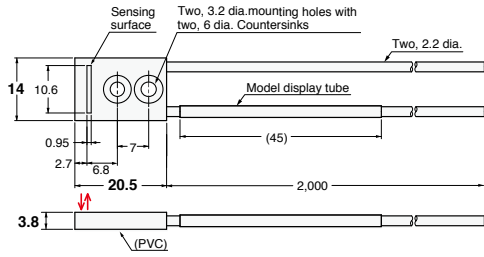

55-B E32-A08 2M (Free Cutting)

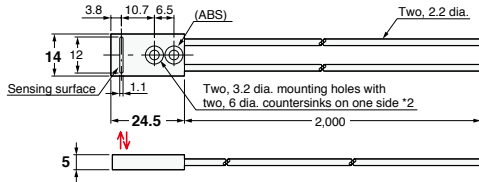

55-C E32-A08H2 2M (No Cutting)

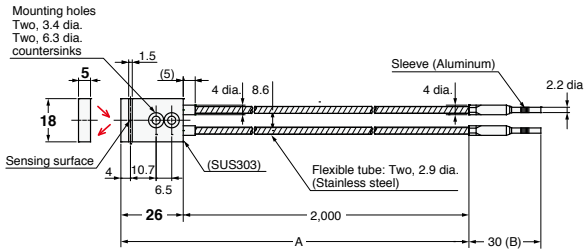

Note: The maximum allowable temperatures is 300°C for sections A and 110°C for section B (section inserted into Amplifier Unit).

Mounting holes

55-D E32-A12 2M (Free Cutting)

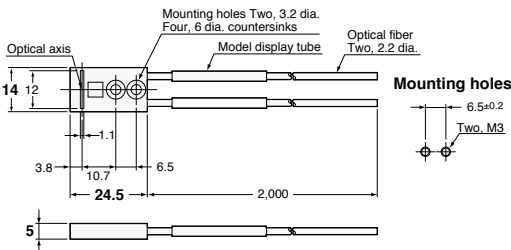

55-E E32-A09 2M (Free Cutting)

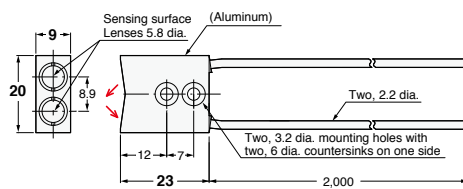

55-F E32-A09H2 2M (No Cutting)

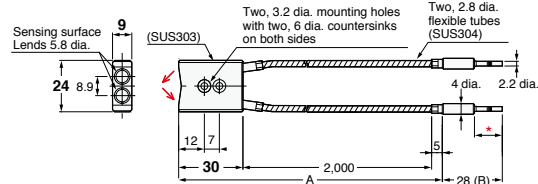

Note: The maximum allowable temperatures for sections A and B are 300°C and 110°C, respectively. The section inserted into the Amplifier Unit (indicated by *) must be maintained within the Amplifier Unit's operating temperature range.

55-G E32-L11FP 2M (Free Cutting)

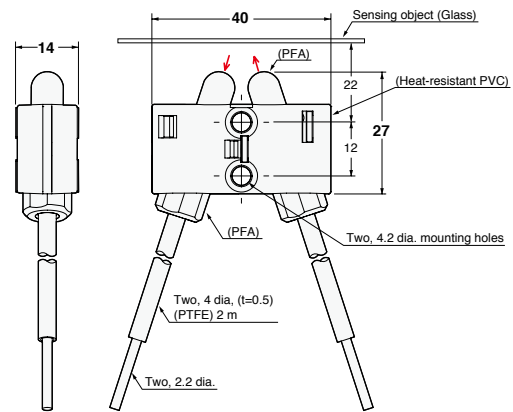

55-H E32-L11FS 2M (Free Cutting)

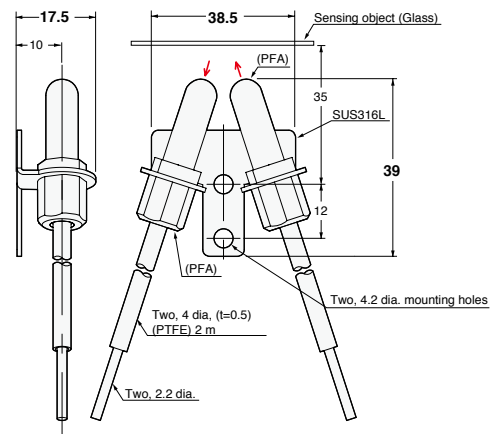

Fiber Sensing Features	
Selection Guide	
Fiber Units	
Threaded	Standard Installation
Cylindrical	
Flat	Saving Space
Sleeved	
Small Spot	Beam Improvements
High Power	
Narrow view	
BGS	
Retro-reflective	Transparent Objects
Limited-reflective	
Chemical-resistant, Oil-resistant	Environmental Immunity
Bending	
Heat-resistant	
Area Detection	Applications
Liquid-level	
Vacuum	
FPD, Semi, Solar	
Installation Information	
Fiber Amplifiers, Communications Unit, and Accessories	
Technical Guide and Precautions	
Model Index	



Wafer Mapping

• Wafer Mapping

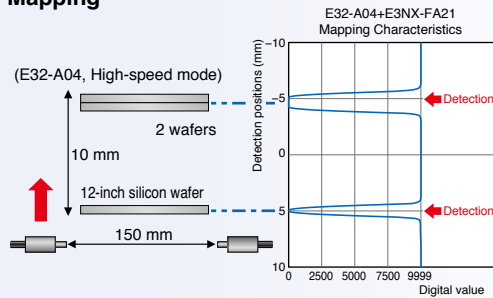

- ▶ Thin-profile design enables easy mounting on robot arms.
- ▶ Easy to adjust optical axis.
(Typical alignment error between mechanical and optical axes is only $\pm 0.1^\circ$.)
- ▶ Reliable wafer detection, even when stacked closely together.

Specifications

Through-beam Fiber Units

Application	Ambient temperature	Aperture angle	Appearance (mm)	Bending radius of cable (mm)	Sensing distance (mm)					Optical axis diameter (minimum sensing object)	Models	Page 57 Dimensions No.
					E3X-HD			E3NX-FA				
					GIGA	HS	Other modes	GIGA	HS			
Wafer Mapping	70°C	1.5°	 Thickness: 3 mm IP50	Flexible**, R1	4,000 *	ST : 1,780	4,000 *	ST : 2,670	2 dia. (0.1 dia./ 0.03 dia.)	E32-A03 2M	57-A	
					1,200	SHS : 500	1,800	SHS : 500				
			 Thickness: 3 mm IP50	R10	1,280	ST : 680	1,920	ST : 1,020		1.2 dia. (0.1 dia./ 0.03 dia.)	E32-A04 2M	57-C
					450	SHS : 200	670	SHS : 200				
		4°	 Thickness: 2 mm IP50	Flexible**, R1	4,000 *	ST : 2,200	4,000 *	ST : 3,300		2 dia. (0.1 dia./ 0.03 dia.)	E32-T24SR 2M	57-D
					1,460	SHS : 580	2,190	SHS : 580				
			 Thickness: 2 mm IP50	R10	4,000 *	ST : 2,600	4,000 *	ST : 3,900			E32-T24S 2M	57-E
					1,740	SHS : 700	2,610	SHS : 700				

* The optical fiber is 2 m long on each side, so the sensing distance is 4,000 mm.
** For a definition, see page 90.

- Note 1.** The following mode names and response times apply to the modes given in the Sensing distance column.
[E3X-HD] GIGA: Giga-power mode (16 ms), HS: High-speed mode (250 μ s), ST: Standard mode (1 ms), and SHS: Super-high-speed mode (NPN output: 50 μ s, PNP output: 55 μ s)
[E3NX-FA] GIGA: Giga-power mode (16 ms), HS: High-speed mode (250 μ s), ST: Standard mode (1 ms), and SHS: Super-high-speed mode (30 μ s)
- Note 2.** The values for the minimum sensing object are reference values that indicate values obtained in standard mode with the sensing distance and sensitivity set to the optimum values.
The first value is for the E3X-HD and the second value is for the E3NX-FA.

Standard Installation	Threaded
	Cylindrical
Saving Space	Flat
	Sleeved
Beam Improvements	Small Spot
	High Power
	Narrow view
	BGS
Transparent Objects	Retro-reflective
	Limited-reflective
Environmental Immunity	Chemical-resistant, Oil-resistant
	Bending
	Heat-resistant
Applications	Area Detection
	Liquid-level
	Vacuum
	FPD, Semi, Solar
Installation Information	

Fiber Amplifiers, Communications Unit, and Accessories
Technical Guide and Precautions
Model Index

Through-beam Fiber Units (Set of 2)

(57-A) E32-A03 2M (Free Cutting)

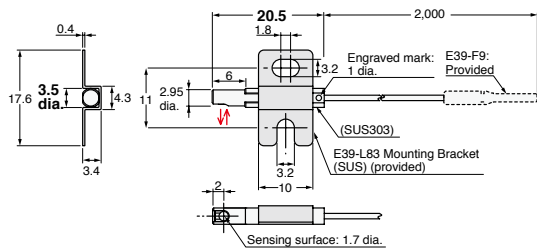

Note: Use the engraved surface and its opposing surface as installation (reference) surfaces.

(57-B) E32-A03-1 2M (Free Cutting)

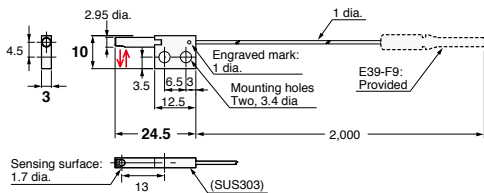

Note1: Use the engraved surface and its opposing surface as installation (reference) surfaces.
Note2: Set of two symmetrical parts.

(57-C) E32-A04 2M (Free Cutting)

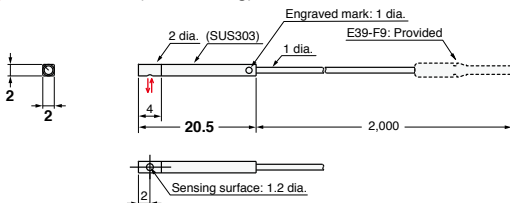

Note: Use the engraved surface and its opposing surface as installation (reference) surfaces.

(57-D) E32-T24SR 2M (Free Cutting)

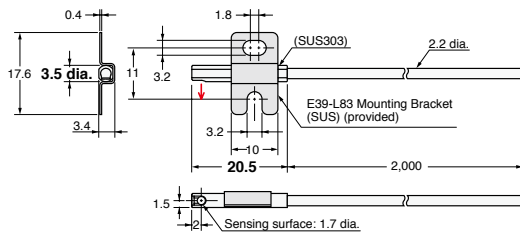

(57-E) E32-T24S 2M (Free Cutting)

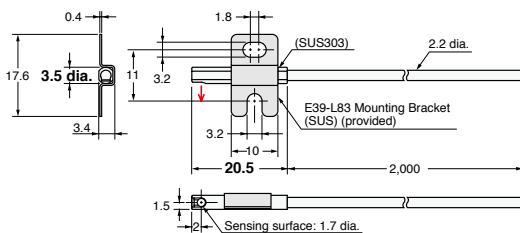

Fiber Sensing Features	
Selection Guide	
Fiber Units	
Threaded	Standard Installation
Cylindrical	
Flat	Saving Space
Sleeved	
Small Spot	Beam Improvements
High Power	
Narrow view	
BGS	
Retro-reflective	Transparent Objects
Limited-reflective	
Chemical-resistant, Oil-resistant	Environmental Immunity
Bending	
Heat-resistant	
Area Detection	Applications
Liquid-level	
Vacuum	
FPD, Semi, Solar	
Installation Information	
Fiber Amplifiers, Communications Unit, and Accessories	
Technical Guide and Precautions	
Model Index	

Models	Installation				Cable					Weight (packed state) (g)	Dimensions Page No.
	Ambient temperature	Tightening torque	Mounting hole	Bending radius (mm)	Unbendable length *1	Tensile strength	Sheath material	Core material	Emitter/receiver differentiation		
E32-D24R 2M	-40 to 70°C	0.29N • m	3.2 ^{+0.5} / ₀ dia.	R1	0	9.8N	Polyethylene	Plastic	None	40	Page 19 (19-A)
E32-D24-S2 2M	-40 to 70°C	0.29N • m	5 ^{+0.5} / ₀ dia.	R25	10	19.6N	Polyethylene	Plastic	None	55	Page 19 (19-B)
E32-D25XB 2M	-40 to 70°C	0.15N • m	-	R4	10	9.8N	PVC	Plastic	None	40	Page 43 (43-F)
E32-D25-S3 2M	-40 to 70°C	0.29N • m	-	R10	10	9.8N	Polyethylene	Plastic	None	50	Page 19 (19-L)
E32-D31-S1 0.5M	-40 to 70°C	0.78N • m	3.2 ^{+0.5} / ₀ dia.	R4	10	9.8N	Polyolefin	Plastic	None	35	Page 19 (19-G)
E32-D32L 2M	-40 to 70°C	0.29N • m	3.2 ^{+0.5} / ₀ dia.	R25	10	29.4N	Polyethylene	Plastic	Yellow dotted line on emitter cable	50	Page 13 (13-E)
E32-D32-S1 0.5M	-40 to 70°C	0.29N • m	3.2 ^{+0.5} / ₀ dia.	R4	10	9.8N	Polyolefin	Plastic	None	35	Page 19 (19-F)
E32-D33 2M	-40 to 70°C	0.29N • m	3.2 ^{+0.5} / ₀ dia.	R4	10	9.8N	Polyethylene	Plastic	None	40	Page 13 (13-F) Page 19 (19-E)
E32-D331 2M	-40 to 70°C	0.29N • m	2.2 ^{+0.5} / ₀ dia.	R4	10	9.8N	Polyethylene	Plastic	None	30	Page 19 (19-D)
E32-D36P1 2M	-40 to 70°C	0.78N • m	-	R4	10	29.4N	Polyethylene	Plastic	None	60	Page 49 (49-D)
E32-D36T 2M	-40 to 70°C	-	-	R4	10	29.4N	Polyethylene	Plastic	None	190	Page 51 (51-C)
E32-D43M 1M	-40 to 70°C	0.29N • m	1.7 ^{+0.5} / ₀ dia.	R4	10	9.8N	Polyethylene	Plastic	None	30	Page 13 (13-B) Page 19 (19-C)
E32-D51 2M	-40 to 150°C *2	0.98N • m	6.2 ^{+0.5} / ₀ dia.	R35	10	29.4N	Fluororesin	Plastic	None	60	Page 47 (47-B)
E32-D51R 2M	-40 to 100°C *3	0.98N • m	6.2 ^{+0.5} / ₀ dia.	R2	0	29.4N	Polyurethane	Plastic	None	60	Page 47 (47-A)
E32-D61-S 2M	-60 to 350°C *4	0.98N • m	6.2 ^{+0.5} / ₀ dia.	R25	10	29.4N	SUS	Glass	None	190	Page 47 (47-G)
E32-D611-S 2M	-60 to 350°C *4	0.98N • m	4.2 ^{+0.5} / ₀ dia.	R25	10	29.4N	SUS	Glass	None	170	Page 47 (47-F)
E32-D73-S 2M	-40 to 400°C *4	0.78N • m	4.2 ^{+0.5} / ₀ dia.	R25	10	29.4N	SUS	Glass	None	170	Page 47 (47-H)
E32-D81R-S 2M	-40 to 200°C *4	0.78N • m	6.2 ^{+0.5} / ₀ dia.	R10	10	9.8N	Fluororesin	Glass	None	70	Page 47 (47-C)
E32-D82F1 4M	-40 to 200°C	0.29N • m	6.5 ^{+0.5} / ₀ dia.	R25	10	29.4N	Fluororesin	Plastic	None	450	Page 51 (51-D)
E32-DC200BR 2M	-40 to 70°C	0.98N • m	6.2 ^{+0.5} / ₀ dia.	R1	0	29.4N	PVC	Plastic	None	60	Page 19 (19-K)
E32-DC200F4R 2M	-40 to 70°C	0.78N • m	3.2 ^{+0.5} / ₀ dia.	R1	0	9.8N	Polyethylene	Plastic	None	40	Page 19 (19-H)
E32-L11FP 2M	-10 to 60°C	0.78N • m	-	R40	10	9.8N	Fluororesin	Plastic	None	310	Page 39 (39-F) Page 55 (55-G)
E32-L11FS 2M	-10 to 85°C	0.78N • m	-	R40	10	9.8N	Fluororesin	Plastic	None	310	Page 39 (39-G) Page 55 (55-H)
E32-L15 2M	-40 to 70°C	0.53N • m	-	R25	10	29.4N	Polyethylene	Plastic	White tube on emitter cable	60	Page 21 (21-F)
E32-L16-N 2M	-40 to 70°C	0.29N • m	-	R25	10	29.4N	Polyethylene	Plastic	None	60	Page 33 (33-A) Page 37 (37-B) Page 55 (55-A)
E32-L24S 2M	-40 to 70°C	0.29N • m	-	R10	10	9.8N	Polyethylene	Plastic	None	40	Page 33 (33-B) Page 37 (37-A)
E32-L25L 2M	-40 to 105°C *3	0.29N • m	-	R10	10	9.8N	Polyethylene	Plastic	None	40	Page 33 (33-C) Page 37 (37-E)
E32-L25T 2M	-40 to 70°C	-	-	R10	10	9.8N	Polyethylene	Plastic	None	40	Page 51 (51-B)
E32-LD11 2M	-40 to 70°C	0.98N • m	-	R25	10	29.4N	Polyethylene	Plastic	None	40	Page 09 (09-I)
E32-LD11R 2M	-40 to 70°C	0.98N • m	-	R1	0	29.4N	Polyethylene	Plastic	None	40	
E32-LT11 2M	-40 to 70°C	0.78N • m	-	R25	10	29.4N	Polyethylene	Plastic	None	40	Page 07 (07-C) Page 25 (25-B)
E32-LT11R 2M	-40 to 70°C	0.78N • m	-	R1	0	29.4N	Polyethylene	Plastic	None	40	
E32-R16 2M	-25 to 55°C	0.54N • m	-	R25	10	29.4N	Polyethylene	Plastic	None	220 (E39-R1 included.)	Page 35 (35-B)
E32-R21 2M	-40 to 70°C	0.39N • m	6.2 ^{+0.5} / ₀ dia.	R10	10	9.8N	Polyethylene	Plastic	None	70 (E39-R3 included.)	35 Page (35-C)

*1 Unbendable length of cable from fiber head. Do not bend the cable for at least 20 mm from where the cable inserts into the Fiber Amplifier Unit.

*2 For continuous operation, use the Fiber Unit between -40 to 130°C.

*3 For continuous operation, use the Fiber Unit between -0 to 90°C.

*4 The heat-resistant rating is not the same for all parts of the Fiber Unit. Refer to the dimensions diagrams for details.

Fiber Sensor Features

Selection Guide

Fiber Units

Threaded

Cylindrical

Flat

Sleeved

Small Spot

High Power

Narrow view

BGS

Retro-reflective

Limited-reflective

Chemical-resistant, Oil-resistant

Bending

Heat-resistant

Area Detection

Liquid-level

Vacuum

FPD, Semi, Solar

Installation Information

Fiber Amplifiers, Communications Unit, and Accessories

Technical Guide and Precautions

Model Index

Fiber Sensors Features	Models	Installation					Cable				Weight (packed state) (g)	Dimensions Page No.	
		Ambient temperature	Tightening torque	Mounting hole	Bending radius (mm)	Unbendable length *1	Tensile strength	Sheath material	Core material	Emitter/receiver differentiation			
Selection Guide	E32-T10V 2M	-25 to 70°C	0.3N • m	–	R25	10	29.4N	Fluororesin	Plastic	None	170	Page 53 (53-D)	
	E32-T11 2M	-40 to 70°C	0.78N • m	4.2 ^{+0.5} ₀ dia.	R4	10	29.4N	PVC	Plastic	None	40	Page 41 (41-C)	
	E32-T11F 2M	-40 to 70°C	0.29N • m	–	R4	10	29.4N	Fluororesin	Plastic	None	60	Page 39 (39-C)	
Fiber Units	E32-T11N 2M	-40 to 70°C	0.78N • m	4.2 ^{+0.5} ₀ dia.	R1	0	29.4N	PVC	Plastic	None	70	Page 07 (07-A)	
	E32-T11NF 2M	-25 to 70°C	12N • m	8.5 ^{+0.5} ₀ dia.	R1	0	29.4N	Fluororesin	Plastic	None	80	Page 39 (39-A)	
	E32-T11R 2M	-40 to 70°C	0.78N • m	4.2 ^{+0.5} ₀ dia.	R1	0	29.4N	PVC	Plastic	None	50	Page 07 (07-B)	
Standard Installation	Threaded	E32-T12F 2M	-40 to 70°C	0.78N • m	5.5 ^{+0.5} ₀ dia.	R40	10	29.4N	Fluororesin	Plastic	None	210	Page 39 (39-B)
	Cylindrical	E32-T12R 2M	-40 to 70°C	0.29N • m	3.2 ^{+0.5} ₀ dia.	R1	0	29.4N	PVC	Plastic	None	60	Page 11 (11-C)
Saving Space	Flat	E32-T14 2M	-40 to 70°C	0.49N • m	–	R25	10	29.4N	Polyethylene	Plastic	None	60	Page 25 (25-C)
	Sleeved	E32-T14F 2M	-40 to 70°C	0.78N • m	5.5 ^{+0.5} ₀ dia.	R40	10	29.4N	Fluororesin	Plastic	None	220	Page 39 (39-D)
Beam Improvements	Small Spot	E32-T14LR 2M	-40 to 70°C	0.29N • m	3.2 ^{+0.5} ₀ dia.	R1	0	29.4N	PVC	Plastic	None	60	Page 11 (11-D)
	High Power	E32-T15XR 2M	-40 to 70°C	0.15N • m	–	R1	0	29.4N	PVC	Plastic	None	60	Page 15 (15-A)
	Narrow view	E32-T15YR 2M	-40 to 70°C	0.15N • m	–	R1	0	29.4N	PVC	Plastic	None	60	Page 15 (15-B)
Transparent Objects	BGS	E32-T15ZR 2M	-40 to 70°C	0.15N • m	–	R1	0	29.4N	PVC	Plastic	None	60	Page 15 (15-C)
	Retro-reflective	E32-T16JR 2M	-40 to 70°C	0.29N • m	–	R1	0	29.4N	PVC	Plastic	None	60	Page 49 (49-B)
	Limited-reflective	E32-T16PR 2M	-40 to 70°C	0.29N • m	–	R1	0	29.4N	PVC	Plastic	None	60	Page 49 (49-A)
Environmental Immunity	Chemical-resistant, Oil-resistant	E32-T16WR 2M	-25 to 55°C	0.29N • m	–	R1	0	9.8N	PVC	Plastic	None	60	Page 49 (49-C)
	Bending	E32-T17L 10M	-40 to 70°C	0.78N • m	14.5 ⁺¹ ₀ dia.	R25	10	29.4N	Polyethylene	Plastic	None	240	Page 25 (25-A)
	Heat-resistant	E32-T21 2M	-40 to 70°C	0.78N • m	3.2 ^{+0.5} ₀ dia.	R4	10	9.8N	PVC	Plastic	None	30	Page 41 (41-B)
Applications	Area Detection	E32-T21-S1 2M	-40 to 70°C	0.78N • m	3.2 ^{+0.5} ₀ dia.	R10	10	9.8N	Polyethylene	Plastic	None	45	Page 17 (17-D)
	Liquid-level	E32-T223R 2M	-40 to 70°C	0.20N • m	1.2 ^{+0.5} ₀ dia.	R1	10	9.8N	Polyethylene	Plastic	None	40	Page 11 (11-A)
	Vacuum	E32-T22B 2M	-40 to 70°C	0.20N • m	1.7 ^{+0.5} ₀ dia.	R4	10	9.8N	PVC	Plastic	None	40	Page 11 (11-B) Page 41 (41-A)
Installation Information	FPD, Semi, Solar	E32-T22S 2M	-40 to 70°C	0.29N • m	3.2 ^{+0.5} ₀ dia.	R10	10	29.4N	PVC	Plastic	None	60	Page 31 (31-F)
		E32-T24E 2M	-40 to 70°C	0.29N • m	2.7 ^{+0.5} ₀ dia.	R10	10	9.8N	Polyethylene	Plastic	None	40	Page 17 (17-B)
		E32-T24R 2M	-40 to 70°C	0.29N • m	2.2 ^{+0.5} ₀ dia.	R1	0	9.8N	Polyethylene	Plastic	None	40	Page 17 (17-A)
Fiber Amplifiers, Communications Unit, and Accessories		E32-T24S 2M	-40 to 70°C	0.29N • m	–	R10	10	29.4N	PVC	Plastic	None	60	Page 31 (31-E) Page 57 (57-E)
		E32-T24SR 2M	-40 to 70°C	0.29N • m	–	R1	0	9.8N	PVC	Plastic	None	60	Page 31 (31-D) Page 57 (57-D)
		E32-T25XB 2M	-40 to 70°C	0.15N • m	–	R4	10	9.8N	PVC	Plastic	None	40	Page 41 (41-D)
Technical Guide and Precautions		E32-T33 1M	-40 to 70°C	0.29N • m	3.2 ^{+0.5} ₀ dia.	R10	10	9.8N	Polyethylene	Plastic	None	40	Page 17 (17-C)
		E32-T51 2M	-40 to 150°C *2	0.78N • m	4.2 ^{+0.5} ₀ dia.	R35	10	29.4N	Fluororesin	Plastic	None	70	Page 45 (45-B)
		E32-T51F 2M	-40 to 150°C *2	0.78N • m	5.5 ^{+0.5} ₀ dia.	R40	10	29.4N	Fluororesin	Plastic	None	220	Page 39 (39-E)
Model Index		E32-T51R 2M	-40 to 100°C *3	0.78N • m	4.2 ^{+0.5} ₀ dia.	R2	0	29.4N	Polyurethane	Plastic	None	60	Page 45 (45-A)
		E32-T51V 1M	-25 to 120°C	0.29N • m	4.2 ^{+0.5} ₀ dia.	R30	10	29.4N	Fluororesin	Glass	None	160	Page 53 (53-A)
		E32-T61-S 2M	-60 to 350°C *4	0.78N • m	4.2 ^{+0.5} ₀ dia.	R25	10	29.4N	SUS	Glass	None	200	Page 45 (45-D)
	E32-T81R-S 2M	-40 to 200°C *4	0.78N • m	4.2 ^{+0.5} ₀ dia.	R10	10	9.8N	Fluororesin	Glass	None	60	Page 45 (45-C)	

*1 Unbendable length of cable from fiber head. Do not bend the cable for at least 20 mm from where the cable inserts into the Fiber Amplifier Unit.

*2 For continuous operation, use the Fiber Unit between -40 to 130°C.

*3 For continuous operation, use the Fiber Unit between -0 to 90°C.

*4 The heat-resistant rating is not the same for all parts of the Fiber Unit. Refer to the dimensions diagrams for details.

Models	Installation				Cable					Weight (packed state) (g)	Dimensions Page No.
	Ambient temperature	Tightening torque	Mounting hole	Bending radius (mm)	Unbendable length *1	Tensile strength	Sheath material	Core material	Emitter/receiver differentiation		
E32-T84SV 1M	-25 to 200°C	0.29N • m	4.5 ^{+0.5} dia.	R25	10	29.4N	SUS	Glass	None	190	Page 53 (53-C)
E32-TC200BR 2M	-40 to 70°C	0.78N • m	4.2 ^{+0.5} dia.	R1	0	29.4N	PVC	Plastic	None	60	Page 17 (17-E)
E32-VF1	-25 to 70°C	-	-	-	-	-	-	-	-	240	Page 53 (53-F)
E32-VF4	-25 to 70°C	-	-	-	-	-	-	-	-	280	Page 53 (53-E)
E39-F1	-40 to 200°C	-	-	-	-	-	-	-	-	2	Page 26 (26-A) Page 27 (27-A) to (27-C) Page 28 (28-A) Page 29 (29-A) to (29-C)
E39-F1-33	-40 to 200°C	-	-	-	-	-	-	-	-	3	Page 28 (28-D)
E39-F11	-	-	-	-	-	-	-	-	-	30	-
E39-F16	-60 to 350°C	-	-	-	-	-	-	-	-	15	Page 26 (26-B) Page 27 (27-D) to (27-F) Page 28 (28-B) Page 29 (29-D) to (29-F), (29-K)
E39-F17	-25 to 70°C	-	-	-	-	-	-	-	-	10	Page 21 (21-B)
E39-F18	-40 to 70°C	-	-	-	-	-	-	-	-	5	Page 23 (23-G), (23-H)
E39-F1V	-25 to 120°C	-	-	-	-	-	-	-	-	3	Page 53 (53-B)
E39-F2	-40 to 200°C	-	-	-	-	-	-	-	-	2	Page 26 (26-C) Page 27 (27-G), (27-H) Page 28 (28-C) Page 29 (29-G) to (29-I)
E39-F32A	-40 to 150°C	-	-	R30	-	-	-	-	-	70	Page 43 (43-G)
E39-F32C	-40 to 150°C	-	-	R30	-	-	-	-	-	110	Page 41 (41-E) Page 43 (43-G)
E39-F32D	-40 to 150°C	-	-	R30	-	-	-	-	-	80	Page 43 (43-G)
E39-F3A	-40 to 70°C	-	-	-	-	-	-	-	-	2	Page 21 (21-A)
E39-F3A-5	-40 to 70°C	-	-	-	-	-	-	-	-	1	Page 23 (23-A), (23-B), (23-C)
E39-F3B	-40 to 70°C	-	-	-	-	-	-	-	-	2	Page 23 (23-D), (23-E), (23-F)
E39-F3C	-40 to 70°C	-	-	-	-	-	-	-	-	1	Page 21 (21-C), (21-D)
E39-F3R	-40 to 70°C	-	-	-	-	-	-	-	-	1	Page 35 (35-A)
E39-R1	-25 to 55°C	-	-	-	-	-	-	-	-	20	Page 35 (35-B)
E39-R3	-40 to 70°C	-	-	-	-	-	-	-	-	20	Page 35 (35-C)
E39-RP37	-25 to 55°C	-	-	-	-	-	-	-	-	4	Page 35 (35-A)

*1 Unbendable length of cable from fiber head.
Do not bend the cable for at least 20 mm from where the cable inserts into the Fiber Amplifier Unit.

Fiber Sensor Features

Selection Guide

Fiber Units

Threaded
Cylindrical
Flat
Sleeved
Small Spot
High Power
Narrow view
BGS
Retro-reflective
Limited-reflective
Chemical-resistant, Oil-resistant
Bending
Heat-resistant
Area Detection
Liquid-level
Vacuum
FPD, Semi, Solar

Standard Installation
Saving Space
Beam Improvements
Transparent Objects
Environmental Immunity
Applications

Installation Information

Fiber Amplifiers, Communications Unit, and Accessories

Technical Guide and Precautions

Model Index

Threaded

Cylindrical

Flat

Sleeved

Small Spot

High Power

Narrow view

BGS

Retro-reflective

Limited-reflective

Chemical-resistant, Oil-resistant

Bending

Heat-resistant

Area Detection

Liquid-level

Vacuum

FPD, Semi, Solar

Smart Fiber Amplifier Units

E3NX-FA Series

A New Level of Performance for Advanced Detection Capability



Page
64

Expanded Application Response Capabilities

Improvements in the sensing distance and minimum sensing object have increased the range of applications with stable detection.

1.5 Times the Sensing Distance*

6 m

For E32-LT11 Fiber Unit with a fiber length of 3.5 m

1/10th the Minimum Sensing Object*

0.3 μm dia.

Typical example of actual measurements with E32-D11R Fiber Unit. *Compared to E3X-HD.

Advanced Smart Tuning

Just press the **E_{TUNE}** button once with a workpiece and once without a workpiece to automatically set the optimum incident level and threshold. Consistent settings are achieved for all users with this ultra-easy procedure.



Automatic Setting of Optimum Values

Threshold + Incident Level

5000 9999

Set to the intermediate value between the incident levels with and without a workpiece. Incident level adjustment with and without a workpiece.

Dynamic Range Increased by a Factor of 40,000

The incident level is optimized to enable stable detection even for saturated or insufficient incident levels.

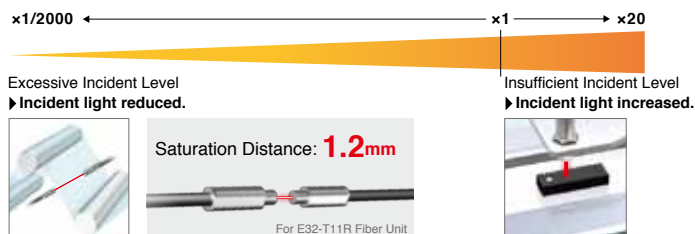

Sensor Communications Units for E3NX-FA

E3NW Series

The Next-generation E3NW Sensor Network Units Revolutionize On-site Sensing



Page
64

The Sensor Communications Unit with a master function and the Distributed Sensor Units with slave functions enable N-Smart Sensor communication over open networks.



Greatly Reduced Machine Manufacturing Costs

There is no need to change the current distributed installation to introduce a network without increasing costs.

Greatly Reduced Machine Commissioning Time

All of the settings can be made at the same time from a Touch Panel.

Greatly Improved Machine Productivity

Realtime monitoring lets you perform maintenance before malfunctions occur.

Smart Fiber Amplifier Units

E3X-HD Series

Affordable Amplifier Units with Simple Operation and Stable Detection Capabilities



Page 78

Sensor Communications Units for E3X-HD



E3X-ECT / E3X-CRT

Sensor Communications Units for CompoNet and EtherCAT



Page 78

<Fiber Amplifier Unit Comparison>

		E3NX-FA Series 	E3X-HD Series 	
Fiber Amplifier Unit specifications	Output	1 or 2 outputs (depending on the model)	1 output	
	External input	Supported or not supported (depending on the model)	not supported	
	Response time	30 μs (32 μs)/250 μs/1 ms/16 ms (Default: 250 μs)	50 μs (55 μs)/250 μs/1 ms/16 ms (Default: 250 μs)	
	Sensing distance (Giga-power mode)	E32-T11R	3,000 mm	2,000 mm
		E32-D11R	1,260 mm	840 mm
Minimum sensing object	E32-T11R	2 μm dia.	5 μm dia.	
Sensor Communications Unit application	Communications method (Sensor Communications Unit model)	EtherCAT (E3NW-ECT)	EtherCAT (E3X-ECT) CompoNet (E3X-CRT)	
	Applicable Sensors	Fiber Sensor (E3NX-FA0) Laser Sensors (E3NC-LA0, E3NC-SA0)	Fiber Sensor (E3X-HD0) Fiber Sensor (E3X-DA0-S, E3X-MDA0) Laser Photoelectric Sensor (E3C-LDA0) Proximity Sensor (E2C-EDA0)	
Page listings	Ordering Information	Page 64	Page 78	
	Ratings and Specifications	Page 66	Page 80	
	Dimensions	Page 68	Page 80	

Fiber Amplifier Unit Accessories









Page 65, 79

Fiber Sensor Features	
Selection Guide	
Fiber Units	
Threaded	Standard Installation
Cylindrical	
Flat	Saving Space
Sleeved	
Small Spot	
High Power	Beam Improvements
Narrow view	
BGS	
Retro-reflective	Transparent Objects
Limited-reflective	
Chemical-resistant, Oil-resistant	Environmental Immunity
Bending	
Heat-resistant	
Area Detection	
Liquid-level	Applications
Vacuum	
FPD, Semi, Solar	
Installation Information	
Fiber Amplifiers, Communications Unit, and Accessories	
Technical Guide and Precautions	
Model Index	

Threaded
CylindricalFlat
SleevedSmall Spot
High Power
Narrow viewRetro-reflective
Limited-reflectiveChemical-resistant,
Oil-resistant
Bending
Heat-resistantArea Detection
Liquid-level
Vacuum

E3NX-FA Fiber Amplifier Units and Related Products

Fiber Amplifier Units E3NX-FA Series

Type	Appearance	Connecting method	Inputs/ outputs	Models		Ratings and Specifications	Dimensions
				NPN output	PNP output		
Standard models		Pre-wired (2 m)	1 output	E3NX-FA11 2M	E3NX-FA41 2M	Page 66	Page 68 (68-A)
		Wire-saving Connector	1 output	E3NX-FA6	E3NX-FA8		Page 68 (68-B)
Advanced models		Pre-wired (2 m)	2 outputs + 1 input	E3NX-FA21 2M	E3NX-FA51 2M		Page 68 (68-A)
		Wire-saving Connector	1 output + 1 input	E3NX-FA7	E3NX-FA9		Page 68 (68-B)
			2 outputs	E3NX-FA7TW	E3NX-FA9TW		Page 69 (69-A)
		M8 Connector	1 output + 1 input	E3NX-FA24	E3NX-FA54		
			2 outputs	E3NX-FA7TW	E3NX-FA54TW		
Model for Sensor Communications Unit		Connector for Sensor Communications Unit	2 outputs	E3NX-FA0			Page 69 (69-B)

Sensor Communications Unit

Sensor Communications Unit

Communication method	Appearance	Applicable Fiber Amplifier Model	Model	Ratings and Specifications	Dimensions
EtherCAT		E3NX-FA0	E3NW-ECT	Page 76	Page 77 (77-A)





* For details, refer to your OMRON website.

Distributed Sensor Unit

Appearance	Applicable Fiber Amplifier Model	Model	Ratings and Specifications	Dimensions
	E3NX-FA0	E3NW-DS	Page 76	Page 77 (77-B)



Wire-saving connectors (Required for Wire-saving Connector type Amplifiers)

Connectors are not provided with the Fiber Amplifier Unit and must be ordered separately. * Protective stickers: provided.

Type	Appearance	Cable length	Number of conductors	Applicable Fiber Amplifier Units	Models	Ratings, Specifications and Dimensions
Master Connector		2m	4	E3NX-FA7 E3NX-FA7TW E3NX-FA9 E3NX-FA9TW	E3X-CN21	Page 88 (88-A)
Slave Connector			2		E3X-CN22	Page 88 (88-B)
Master Connector			3	E3NX-FA6 E3NX-FA8	E3X-CN11	Page 88 (88-A)
Slave Connector			1		E3X-CN12	Page 88 (88-B)

Sensor I/O Connectors (Required for models with M8 Connectors.)

Connectors are not provided with the Fiber Amplifier Unit and must be ordered separately. * Protective stickers: provided.

Appearance	Cable length	Number of conductors	Models	Ratings and Specifications	Dimensions
Straight 	2m	4	XS3F-M421-402-A	Page 88	Page 88 (88-C)
	5m		XS3F-M421-405-A		
L-shaped 	2m		XS3F-M422-402-A		Page 88 (88-D)
	5m		XS3F-M422-405-A		

Mounting Bracket

A Mounting Bracket is not provided with the Fiber Amplifier Unit and must be ordered separately as required.

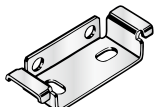
Appearance	Model	Quantity	Dimensions
	E39-L143	1	Page 89 (89-A)

DIN Track

A Din Track is not provided with the Fiber Amplifier Unit and must be ordered separately as required.

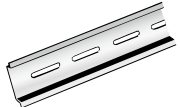
Appearance	Type	Models	Quantity	Dimensions
	Shallow type, total length: 1 m	PFP-100N	1	Page 89 (89-B)
	Shallow type, total length: 0.5 m	PFP-50N		
	Deep type, total length: 1 m	PFP-100N2		Page 89 (89-C)

End Plate

Two End Plates are provided with the Sensor Communications Unit.

End Plates are not provided with the Fiber Amplifier Unit and must be ordered separately as required.

Appearance	Model	Quantity	Dimensions
	PFP-M	1	Page 89 (89-D)

Threaded
Cylindrical

Flat
Sleeved

Small Spot
High Power

Retro-reflective
Limited-reflective

Chemical-resistant, Oil-resistant
Bending
Heat-resistant

Area Detection
Liquid-level
Vacuum

FPD, Semi, Solar

Item	Type	Standard		Advanced					Model for Sensor Communications Unit
	NPN output	E3NX-FA11	E3NX-FA6	E3NX-FA21	E3NX-FA7	E3NX-FA7TW	E3NX-FA24	—	E3NX-FA0
	PNP output	E3NX-FA41	E3NX-FA8	E3NX-FA51	E3NX-FA9	E3NX-FA9TW	E3NX-FA54	E3NX-FA54TW	
Connecting method	Pre-wired	Wire-saving Connector	Pre-wired	Wire-saving Connector	M8 Connector			Connector for Sensor Communications Unit	
Inputs / Outputs	Output	1 output		2 outputs	1 output	2 outputs	1 output	2 outputs	— *1
	External input	—		1 input	1 input	—	1 input	—	
Light source (wavelength)		Red, 4-element LED (625 nm)							
Power supply voltage		10 to 30 VDC , including 10% ripple (p-p)							
Power consumption *2		At Power Supply Voltage of 24 VDC. Standard Models or Model for Sensor Communications Unit: Normal mode: 960 mW max. (Current consumption: 40 mA max.) Power saving Eco mode: 840 mW max.(Current consumption: 35 mA max.) Advanced Models: Normal mode: 1,080 mW max. (Current consumption: 45 mA max.) Power saving Eco mode: 930 mW max.(Current consumption: 40 mA max.)							
Control output		Load power supply voltage: 30 VDC max., open-collector output Load current: Groups of 1 to 3 Amplifier Units: 100 mA max., Groups of 4 to 30 Amplifier Units: 20 mA max. (Residual voltage: At load current of less than 10 mA: 1 V max., At load current of 10 to 100 mA: 2 V max.) OFF current: 0.1 mA max.							—
External input		—	Refer to *3.		—	Refer to *3.		—	
Indicators		7-segment displays (Sub digital display: green, Main digital display: white) Display direction: Switchable between normal and reversed. OUT indicator (orange), L/D indicator (orange), ST indicator (blue), DPC indicator (green) OUT Selection Indicator (orange)(only on models with 2 outputs)							
Protection circuits		Power supply reverse polarity protection, output short-circuit protection, and output reverse polarity protection							Power supply reverse polarity protection and output short-circuit protection
Response time	Super-high-speed mode (SHS) *4	Operate or reset for model with 1 output: 30 μs, with 2 outputs: 32 μs							
	High-speed mode (HS)	Operate or reset: 250 μs							
	Standard mode (Std)	Operate or reset: 1 ms							
	Giga-power mode (GIGA)	Operate or reset: 16 ms							
Sensitivity adjustment		Smart tuning (2-point tuning, full auto tuning, position tuning, maximum sensitivity tuning, power tuning, or percentage tuning (–99% to 99%)) or manual adjustment							
Mutual interference prevention	Super-high-speed mode (SHS) *4	Possible for up to 0 units							
	High-speed mode (HS)	Possible for up to 10 units							
	Standard mode (Std)	Possible for up to 10 units							
	Giga-power mode (GIGA)	Possible for up to 10 units							
Functions	Auto power control (APC)	Always ON							
	Dynamic power control (DPC)	Provided							
	Timer	Select from timer disabled, OFF-delay, ON-delay, one-shot, or ON-delay + OFF-delay timer. 1ms to 9999ms							
	Zero reset	Negative values can be displayed. (Threshold value is shifted.)							
	Resetting settings *5	Select from initial reset (factory defaults) or user reset (saved settings).							

*1. Two sensor outputs are allocated in the programmable logic controller PLC I/O table. PLC operation via Communications Unit enables reading detected values and changing settings.

*2. At Power Supply Voltage of 10 to 30 VDC.
 Standard Models or Model for Sensor Communications Unit:
 Normal mode: 1,080 mW max. (Current consumption: 36 mA max. at 30 VDC, 108 mA max. at 10 VDC)
 Power saving Eco mode: 930 mW max. (Current consumption: 31 mA max. at 30 VDC, 93 mA max. at 10 VDC)
 Advanced Models:
 Normal mode: 1,230 mW max. (Current consumption: 41 mA max. at 30 VDC, 123 mA max. at 10 VDC)
 Power saving Eco mode: 1,050 mW max. (Current consumption: 35 mA max. at 30 VDC, 105 mA max. at 10 VDC)

*3. The following details apply to the input.

	Contact input (relay or switch)		Non-contact input (transistor)	Input time
NPN type	ON: Shorted to 0V (Sourcing current: 1 mA max.). OFF: Open or shorted to Vcc.	ON: 1.5V max. (Sourcing current: 1 mA max.). OFF: Vcc – 1.5 V to Vcc (Leakage current: 0.1 mA max.)	ON : 9ms min. OFF : 9ms min.	
PNP type	ON: Shorted to Vcc (Sinking current: 3 mA max.). OFF: Open or shorted to 0V.	ON: Vcc – 1.5 V to Vcc (Sinking current: 3 mA max.). OFF: 1.5V max.(Leakage current: 0.1 mA max.)		

*4. The mutual interference prevention function is disabled if the detection mode is set to super-high-speed mode.

*5. The bank is not reset by the user reset function or saved by the user save function.

Item	Type	Standard		Advanced					Model for Sensor Communications Unit
	NPN output	E3NX-FA11	E3NX-FA6	E3NX-FA21	E3NX-FA7	E3NX-FA7TW	E3NX-FA24	—	E3NX-FA0
	PNP output	E3NX-FA41	E3NX-FA8	E3NX-FA51	E3NX-FA9	E3NX-FA9TW	E3NX-FA54	E3NX-FA54TW	
	Connecting method	Pre-wired	Wire-saving Connector	Pre-wired	Wire-saving Connector		M8 Connector		Connector for Sensor Communications Unit
Functions	Eco mode	Select from OFF (digital displays lit) or ECO (digital displays not lit).							
	Bank switching	Select from banks 1 to 4.							
	Power tuning	Select from ON or OFF.							
	Output 1	Select from normal detection mode, or area detection mode.							
	Output 2	—		Select from normal detection mode, alarm output mode, or error output mode.	—		Select from normal detection mode, alarm output mode, or error output mode.	—	Select from normal detection mode, alarm output mode, or error output mode.
	External input	—		Select from input OFF, tuning, power tuning, emission OFF, zero reset, or bank switching.	—		Select from input OFF, tuning, power tuning, emission OFF, zero reset, or bank switching.	—	—
	Hysteresis width	Select from standard setting or user setting. For a user setting, the hysteresis width can be set to from 0 to 9,999.							
Ambient Illumination (Receiver side)	Incandescent lamp: 20,000 lx max., Sunlight: 30,000 lx max.								
Maximum connectable Units	30 units								
Ambient temperature range	Operating: Groups of 1 to 2 Amplifier Units: -25 to 55°C, Groups of 3 to 10 Amplifier Units: -25 to 50°C, Groups of 11 to 16 Amplifier Units: -25 to 45°C, Groups of 17 to 30 Amplifier Units: -25 to 40°C Storage: -30 to 70°C (with no icing or condensation)						Operating: Groups of 1 to 2 Amplifier Units: 0 to 55°C, Groups of 3 to 10 Amplifier Units: 0 to 50°C, Groups of 11 to 16 Amplifier Units: 0 to 45°C, Groups of 17 to 30 Amplifier Units: 0 to 40°C Storage: -30 to 70°C (with no icing or condensation)		
Ambient humidity range	Operating and storage: 35% to 85% (with no condensation)								
Insulation resistance	20 MΩ min. (at 500 VDC)								
Dielectric strength	1,000 VAC at 50/60 Hz for 1 min								
Vibration resistance (destruction)	10 to 55 Hz with a 1.5-mm double amplitude for 2 hours each in X, Y, and Z directions								
Shock resistance (destruction)	500 m/s ² for 3 times each in X, Y, and Z directions						150 m/s ² for 3 times each in X, Y, and Z directions		
Weight (packed state/unit only)	Approx. 115 g/ Approx. 75 g	Approx. 60 g/ Approx. 20 g	Approx. 115 g/ Approx. 75 g	Approx. 60 g/Approx. 20 g		Approx. 65 g/Approx. 25 g			
Materials	Case	Polycarbonate (PC)							
	Cover	Polycarbonate (PC)							
	Cable	PVC							
Accessories	Instruction Manual								

Pre-wired Amplifier Units

- 68-A E3NX-FA11
- E3NX-FA21
- E3NX-FA41
- E3NX-FA51

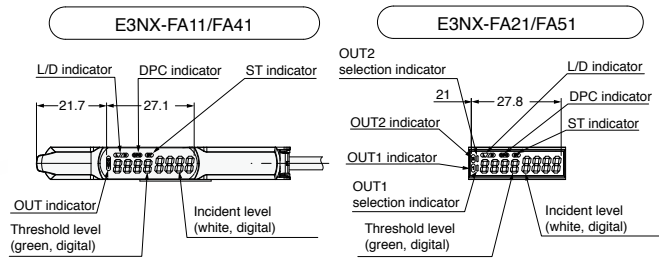

*Cable Specifications

Models	Outer diameter	Number of conductors	Others
E3NX-FA11	4.0 dia.	3	Conductor cross-section: 0.2 mm ² Insulator dia.: 0.9 mm
E3NX-FA41	4.0 dia.	3	
E3NX-FA21	4.0 dia.	5	Standard length: 2 m Minimum bending radius: 12 mm
E3NX-FA51	4.0 dia.	5	

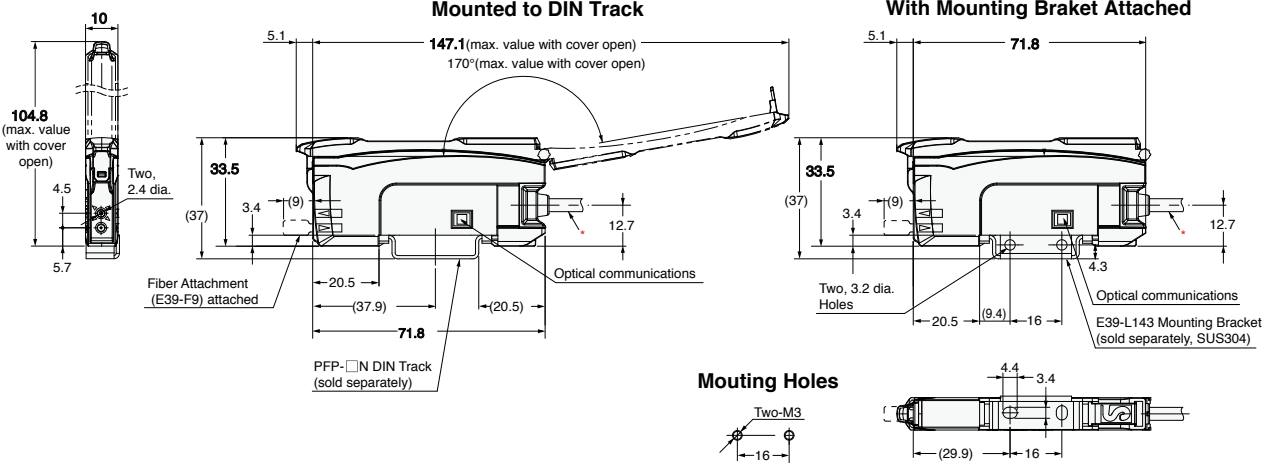

Amplifier Units with Wire-saving Connectors

- 68-B E3NX-FA6
- E3NX-FA7
- E3NX-FA7TW
- E3NX-FA8
- E3NX-FA9
- E3NX-FA9TW

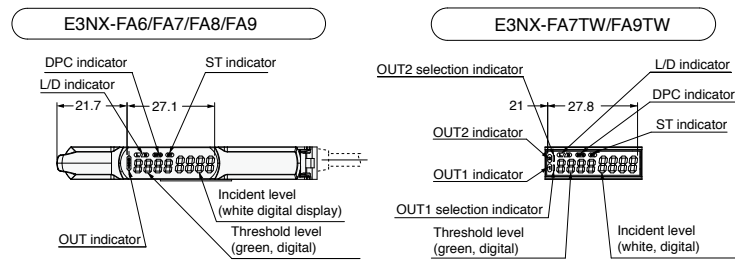

*Cable Specifications

Models	Outer diameter	Number of conductors
E3X-CN12	2.6 dia.	1
E3X-CN22	2.6 dia.	2
E3X-CN11	4.0 dia.	3
E3X-CN21	4.0 dia.	4

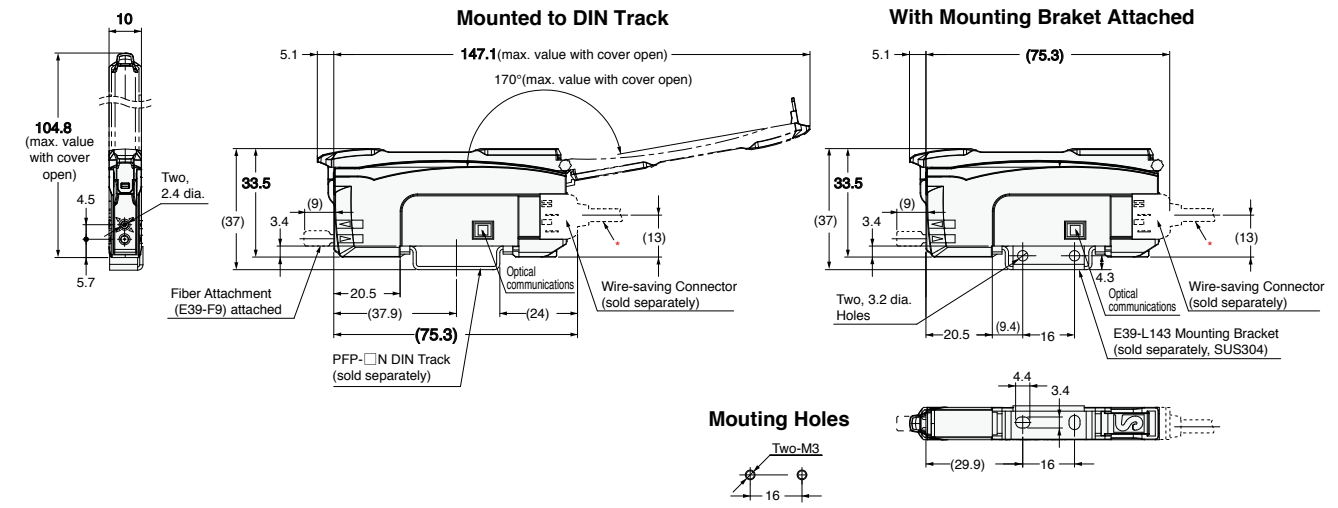

- Fiber Sensors Features
- Selection Guide
- Fiber Units
- Standard Installation
- Threaded
- Cylindrical
- Saving Space
- Flat
- Sleeved
- Beam Improvements
- Small Spot
- High Power
- Narrow view
- BGS
- Transparent Objects
- Retro-reflective
- Limited-reflective
- Chemical-resistant, Oil-resistant
- Bending
- Environmental Immunity
- Heat-resistant
- Area Detection
- Liquid-level
- Vacuum
- FPD, Semi, Solar
- Installation Information
- Fiber Amplifiers, Communications Unit, and Accessories
- Technical Guide and Precautions
- Model Index

Amplifier Units with M8 Connector

69-A E3NX-FA24
E3NX-FA54
E3NX-FA54TW

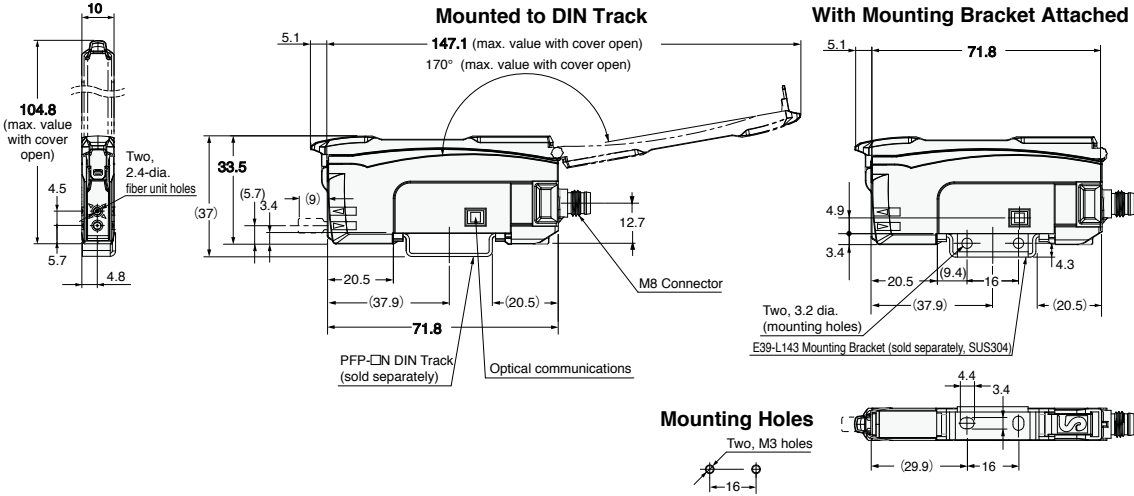
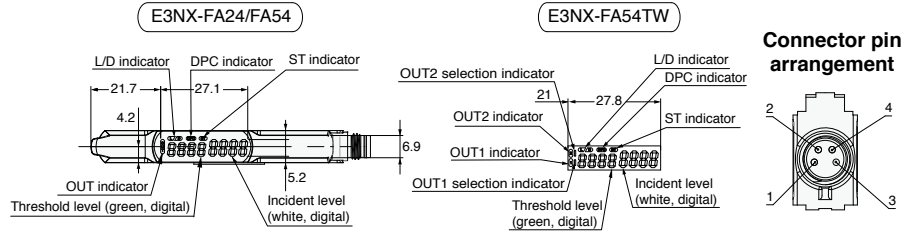

Amplifier Unit with Connector for Sensor Communications Unit

69-B E3NX-FA0

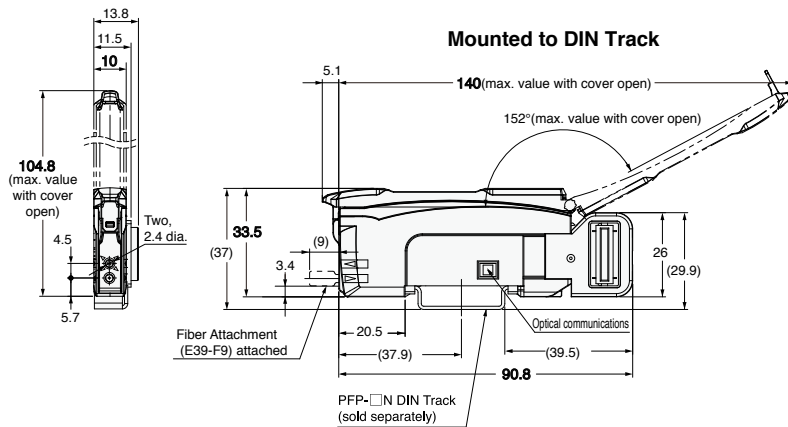
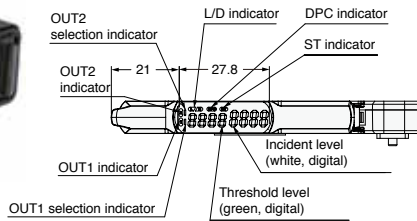

Fiber Sensing Features

Selection Guide

Fiber Units

Threaded

Standard Installation

Cylindrical

Flat

Saving Space

Sleeved

Small Spot

High Power

Beam Improvements

Narrow view

BGS

Retro-reflective

Transparent Objects

Limited-reflective

Chemical-resistant, Oil-resistant

Environmental Immunity

Bending

Heat-resistant

Area Detection

Applications

Liquid-level

Vacuum

FPD, Semi, Solar

Installation Information

Fiber Amplifiers, Communications Unit, and Accessories

Technical Guide and Precautions

Model Index

NPN Output

Models	Operation mode	Timing chart	L/D indicators	Output circuit
E3NX-FA11 E3NX-FA6	Light-ON		L lit.	
	Dark-ON		D lit.	
E3NX-FA21	Light-ON		L lit.	
	Dark-ON		D lit.	
E3NX-FA7 E3NX-FA24	Light-ON		L lit.	
	Dark-ON		D lit.	
E3NX-FA7TW	Light-ON		L lit.	
	Dark-ON		D lit.	

Fiber Sensors Features

Selection Guide

Fiber Units

Standard Installation

- Threaded
- Cylindrical

Saving Space

- Flat
- Sleeved

Beam Improvements

- Small Spot
- High Power
- Narrow view
- BGS

Transparent Objects

- Retro-reflective
- Limited-reflective

Environmental Immunity

- Chemical-resistant, Oil-resistant
- Bending
- Heat-resistant

Applications

- Area Detection
- Liquid-level
- Vacuum
- FPD, Semi, Solar

Installation Information

Fiber Amplifiers, Communications Unit, and Accessories

Technical Guide and Precautions

Model Index

PNP Output

Models	Operation mode	Timing chart	L/D indicators	Output circuit
E3NX-FA41 E3NX-FA8	Light-ON		L lit.	
	Dark-ON		D lit.	
E3NX-FA51	Light-ON		L lit.	
	Dark-ON		D lit.	
E3NX-FA9 E3NX-FA54	Light-ON		L lit.	
	Dark-ON		D lit.	
E3NX-FA9TW E3NX-FA54TW	Light-ON		L lit.	
	Dark-ON		D lit.	

Fiber Sensor Features	
Selection Guide	
Fiber Units	
Threaded	Standard installation
Cylindrical	
Flat	Saving Space
Sleeved	
Small Spot	Beam Improvements
High Power	
Narrow view	
BGS	
Retro-reflective	Transparent Objects
Limited-reflective	
Chemical-resistant, Oil-resistant	Environmental Immunity
Bending	
Heat-resistant	
Area Detection	Applications
Liquid-level	
Vacuum	
FPD, Semi, Solar	
Installation Information	
Fiber Amplifiers, Communications Unit, and Accessories	
Technical Guide and Precautions	
Model Index	

E3NX-FA11/FA41/FA6/FA8/FA7/FA9/FA24/FA54

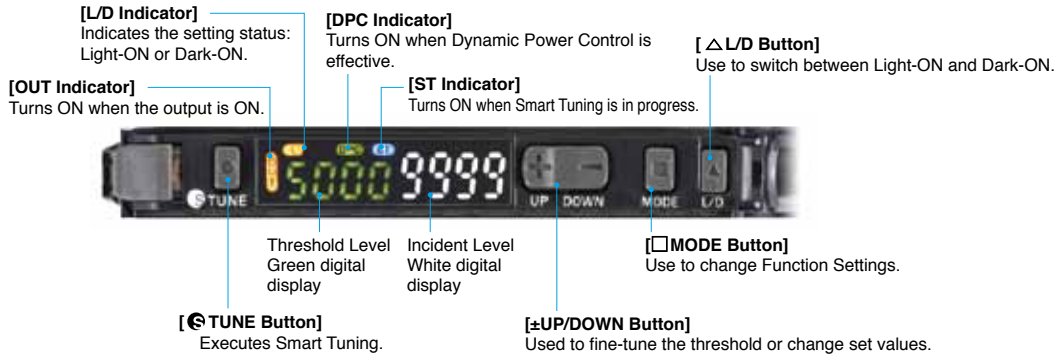

E3NX-FA21/FA51/FA7TW/FA9TW/FA54TW/FAO

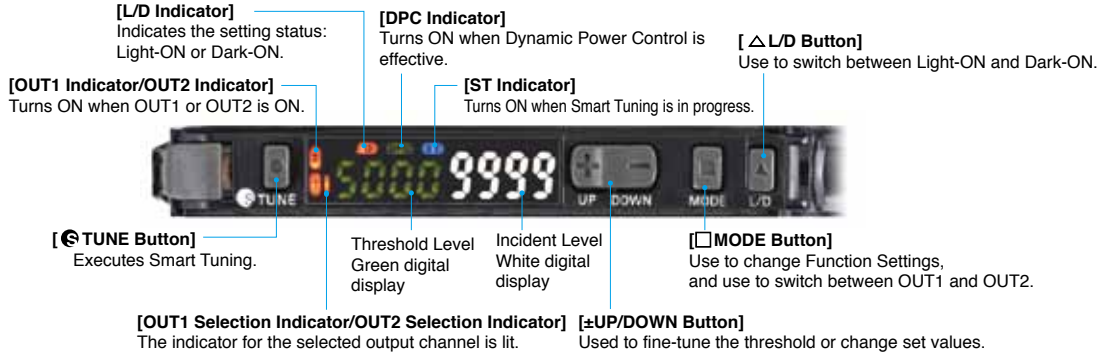

Operating Procedures

Basic Settings

Switching Control Output

1. Press button.

Through-beam:
Set to "Dark ON" to turn the output ON with a workpiece in the detection area. [L/D Indicator] turns ON.

Reflective:
Set to "Light ON" to turn the output ON with a workpiece in the detection area. [L/D Indicator] turns ON.

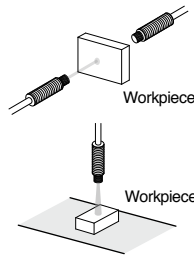

Smart Tuning [Easy Sensitivity Setting]

(1) Detect for Workpiece Presence/Absence

- 2-point Tuning

1. Press button with a workpiece in the detection area.
2. Press button again without a workpiece in the detection area. Release the button when is displayed.

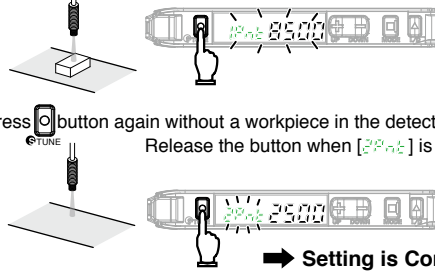

Incident light level setting:
The larger incident level of the Step 1 and 2 values is adjusted to the power tuning level.

Threshold setting:
Set to the middle between the Step 1 and 2 incident light levels.

Step 1 and Step 2 can be reversed.

(2) Enhance Durability of the Fiber Head against Dust and Dirt

- Maximum Sensitivity Tuning

1. Hold button for 3 seconds or longer with/without workpiece as shown below. Release the button when is displayed.

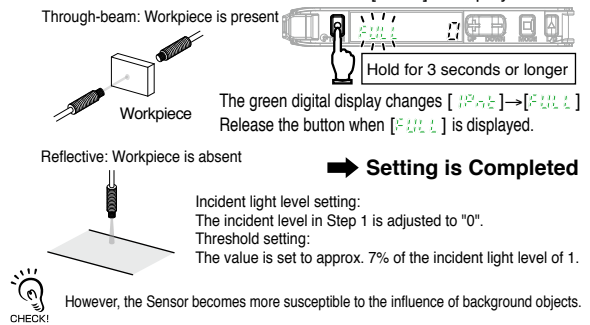

➔ Setting is Completed

(3) Adjust for Moving Workpiece without Stopping Line

- Full Auto Tuning

1. Hold the button without the presence of a workpiece, and pass the workpiece through while [] → [] → [] is displayed in green digital.

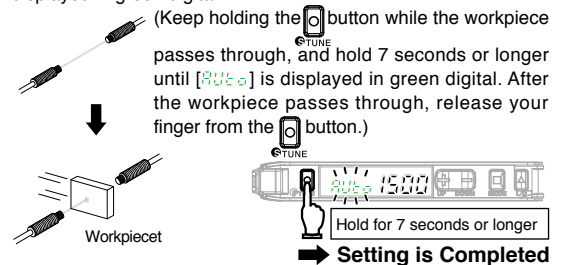

Incident light level setting: Adjust the max. incident light level on Step 1 as the power tuning level.
Threshold setting: Set to the middle between max. and min. incident light levels on Step 1.

Fiber Sensors Features

Selection Guide

Fiber Units

Standard Installation

Saving Space

Beam Improvements

Transparent Objects

Environmental Immunity

Applications

Installation Information

Fiber Amplifiers, Communications Unit, and Accessories

Technical Guide and Precautions

Model Index

(4) Determine Workpiece Position

• Position Tuning

1. Turn ON power tuning in SET mode. Refer to "Detailed Settings"

2. Press button without a workpiece in the area.

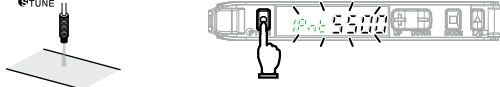

3. Place the workpiece at the desired position and hold button.

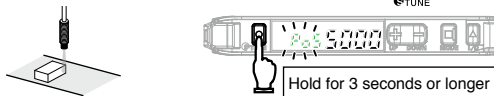

The green digital display changes [5.00] → [5.05].
Setting is Completed

Incident light level setting: The Step 3 incident level is adjusted to half the power tuning level.
 Threshold setting: Set to the same value as the Step 3 incident level.

(5) Detect Transparent or Small Workpiece (Set Threshold by incident light level percentage)

• Percentage Tuning

1. Turn ON Percentage Tuning in SET mode.

2. Press button without a workpiece in the area. Refer to "Detailed Settings"

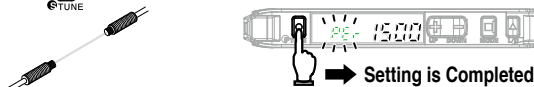

Incident light level setting:
 The Step 2 incident light level is adjusted to the power tuning level.
 Threshold setting:
 Set to the value obtained by [Incident Level at Step 2 × (1 + Percentage Tuning Level)].

No Smart Tuning other than Power Tuning can be used if Percentage Tuning is set.

(6) Restore from the Incident Level Changed due to Dust and Dirt

• Power Tuning

1. Hold and buttons for 1 second or longer without a workpiece in the area.

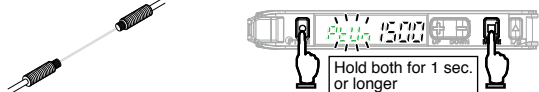

Setting is Completed

Incident light level setting: The Step 1 incident level is adjusted to the power tuning level.
 Threshold setting: Not changed.

Perform the procedure with a workpiece in the area for reflective model setting. If the setting is made after position tuning, set both the through-beam model and reflective model with a workpiece.

Refer to "Smart Tuning Error" for error displays.

• Smart Tuning Error

Error / Display / Cause	Error Origin Tuning Type	Remedy
Near Error The light level difference between Points 1 and 2 are extremely small.	2-point Tuning Full Auto Tuning	<ul style="list-style-type: none"> Change the detection function mode to a slower response time mode. Reduce the distance between the emitter and receiver. (Through-beam) Place the Fiber Head closer to the sensing object. (Reflective)
Over Error Incident light level is too high.	Tuning other than Maximum Sensitivity Tuning	<ul style="list-style-type: none"> Use a thin-diameter fiber. Widen the emitter and receiver distance. (Through-beam) Distance the Fiber Head from the sensing object. (Reflective)
Low Error Incident light level is too low.	Tuning other than Maximum Sensitivity Tuning	<ul style="list-style-type: none"> Reduce the distance between the emitter and receiver. (Through-beam) Place the Fiber Head closer to the sensing object. (Reflective)

The adjustment range of smart tuning is approx. 20 to 1/100 times. When selecting giga mode as detection function, the range will be approx. 2 to 1/100 times due to the large initial value.

Refer to "Detailed Settings" to change the power tuning level.

Changing the Output

(Models with 2 Outputs: E3NX-FA21, E3NX-FA51, E3NX-FA7TW, E3NX-FA9TW) and E3NX-FA54TW

The OUT selection indicators and the settings will change.

- Press button for 1 second.
- The OUT selection indicators (OUT1/OUT2) switch.

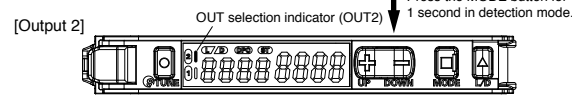
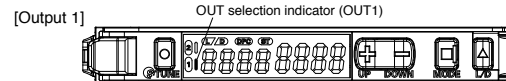

In the detailed settings, the OUT selection indicators will each light whenever the output (OUT1/OUT2) is set.

Minute Adjustment of Threshold Level

- Press button to adjust the threshold level.

The threshold level becomes higher. The threshold level becomes lower.



Hold the key for high-speed level adjustment.

Convenient Setting Features

(1) Stable Detection Regardless of Incident Level Change due to Dust and Dirt

- DPC Function (Use of the function with Through-beam model or Retro-reflective model is recommended)

- Perform Smart Tuning.

Refer to "Smart Tuning"
 Refer to "Power Tuning"

The DPC indicator turns ON when the DPC function is effective.

- Set the DPC function ON in SET mode.

Refer to "Detailed Settings"

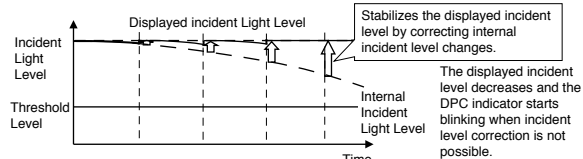
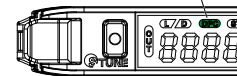

(2) Reset Settings

- Setting Reset

Initializes all the settings by returning them to the factory defaults.

- Hold button and then hold button for 3 seconds or longer.



- Press button.

- Select [] in and press button.

(3) Save or Read Settings

- Hold button and then hold button for 3 seconds or longer.

- User Save Function

Saves the current settings.

- Select [] in and press button.

- Select [] in and press button.

- User Reset Function

Reads out the saved settings.

- Select [] in and press button.

- Select [] in and press button.

(4) Prevent Mistake-operation

- Key Lock Function

Disables all button operations. [] is displayed when the button is pressed.

- Enable/Cancel (This procedure)

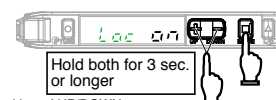

* Press either of UP/DOWN.

Fiber Sensing Features	
Selection Guide	
Fiber Units	
Threaded	Standard Installation
Cylindrical	
Flat	Saving Space
Sleeved	
Small Spot	
High Power	Beam Improvements
Narrow view	
BGS	
Retro-reflective	Transparent Objects
Limited-reflective	
Chemical-resistant, Oil-resistant	Environmental Immunity
Bending	
Heat-resistant	
Area Detection	Applications
Liquid-level	
Vacuum	
FPD, Semi, Solar	
Installation Information	
Fiber Amplifiers, Communications Unit, and Accessories	
Technical Guide and Precautions	
Model Index	

(5) Reset Incident Light Level to "0"

• Zero Reset Function

Changes the incident light level to "0". The threshold level is also shifted accordingly. The lower limit of the threshold is -1,999.

■ Enable

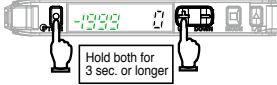

■ Cancel

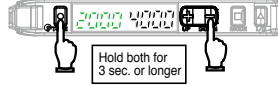

(6) Producing an Output When the Incident Level is within an Area

• Area Detection Mode

1. Select [SET Mode] - [OUT1 Mode] - [Area Detection Mode]. Press MODE button for at least 3 seconds to leave the SET mode.

2. Press MODE button in [Detection Mode] to display OUT1 HIGH and OUT 1 LOW. "HIGH" and "LOW" will appear on the green digital display.

3. Press TUNE button for the high and low thresholds to execute smart tuning.



Percentage Tuning: The thresholds are set as follows:
High: Incident level from step 3 + Incident level from step 3 x Percentage tuning level
Low: Incident level from step 3 - Incident level from step 3 x Percentage tuning level

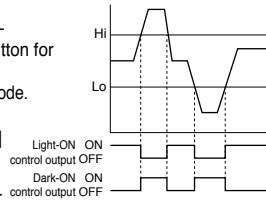

(7) Monitoring the Incident Level for Sensing Objects Passing at High Speed

• Change Finder

1. Select [SET Mode] → [Digital Display] to set [CH FINDER].
2. Press MODE button for 3 seconds or longer to leave the SET mode.
3. Send a workpiece past the Fiber Unit.
4. The maximum and minimum incident levels will be displayed for 0.5 seconds when the workpiece passes.



The Change Finder cannot be displayed in SET mode.

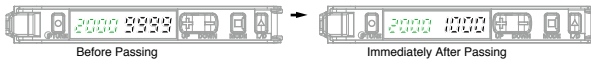

(8) Determining If the Workpiece Can Be Detected

• Solution Viewer

1. Press MODE button and UP button together for 3 seconds or longer to set [Sol V]. To clear the setting, press MODE button and LD button together for 3 seconds or longer to set [Sol V OFF].
2. Send a workpiece past the Fiber Unit.
3. Displaying the Passing Time and Difference in Incident Levels.
4. Press MODE button and UP button together for 3 seconds or longer to leave SET mode.

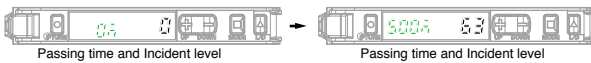
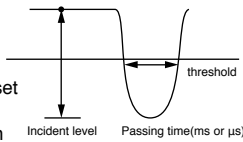

Hold MODE button for 3 seconds or longer to enter SET mode. The OUT selection indicators shows items for output 1 or output 2 individually for each output. SET mode provides the function settings described hereafter. The initial display shown after transition from one function to another represents the factory default.

Function Setting	Description
------------------	-------------

1. Function Selection



2. Detection Function

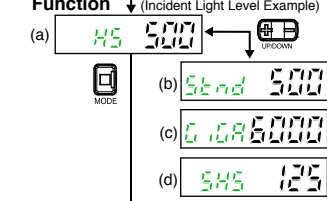

3. DPC Function

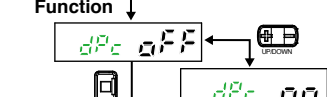

4. Timer Function

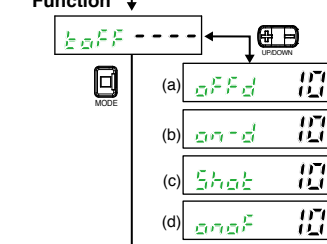

5. Power Tuning Level

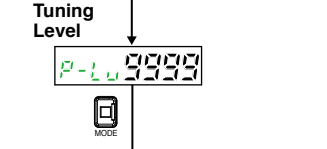

6. BANK Switching

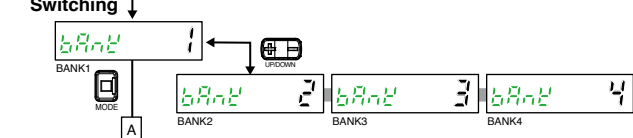

Changing Functions to Set in SET mode

[OFF]: Functions 1. to 5. can be set
[ON]: Functions 1. to 16. can be set.

Changing Light Level and Response Time

Detection Function	Response Time	Light Level
(a) HS High-speed mode	250 μs	1(Standard)
(b) STND Standard mode	1ms	1 time
(c) GIGA Giga mode	16ms	12 times
(d) SHS Super-high-speed mode*	30μs	0.25 times

Smart Tuning is canceled if the detection mode is changed.

* The communication and mutual interference prevention functions are disabled when the detection mode is set to super-high-speed mode. The response time for models with 2 outputs is 32 μs

The incident light level in SET mode is a reference value. It may be changed when switched to detection mode.

Stable Detection Regardless of Incident Light Level Change

Refer to "Convenient Setting Features"

Setting Output Timer

(Settings are displayed for both outputs for models with 2 outputs.)

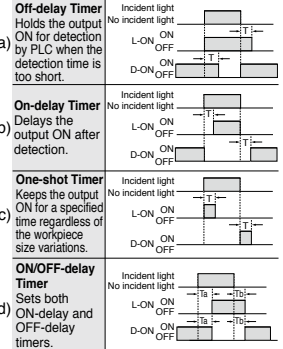

A timer value can be set after pressing MODE button when a timer menu (other display than "----") is displayed. Use UPDOWN button to set the time. (1 to 9999 ms in 1 ms steps; the initial value: 10 ms)

Changing the Target Incident Light Level (Power Tuning Level)

Use UPDOWN button to set the power tuning level. [100 to 9999 in 1 steps; the initial value: 9999] Refer to "Convenient Setting Features"

Saving Settings in Each Bank

Function Setting	Description															
7. Power Tuning ON/OFF Setting 	Setting ON or OFF Incident Level Adjustment when Tuning 															
8. Percentage Tuning 	Detecting Transparent or Small Workpiece Press [MODE] button in [PER ON] menu, then use [UP/DOWN] button to set the percentage tuning level. (-99% to 99% in 1% steps; the initial value: -10%) Refer to "Smart Tuning"															
9. Output 1 Mode 	Changing the Output Mode for Output 1 															
10. Output 2 Mode 	Changing the Output Mode for Output 2 Alarm Output Mode: Press [MODE] button and then set the alarm output level with [UP/DOWN] button. (0 to 100 P in 1-P increments, default: 50 P) ON-delay of 300 ms is applied. Error Output Mode: An output is made when a DPC error, EEPROM error, or system error occurs.															
11. External Input 	Changing the Type of External Input The closed-circuit input time for tuning is the same as the key input time.															
12. Digital Display 	Changing Digital Display in RUN Mode for Specific Purpose <table border="1"> <thead> <tr> <th></th> <th>First point</th> <th>Second point</th> </tr> </thead> <tbody> <tr> <td>2-point Tuning</td> <td>3.0 s or shorter</td> <td>3.0 s or shorter</td> </tr> <tr> <td>Maximum Sensitivity Tuning</td> <td>3.0 s or longer</td> <td></td> </tr> <tr> <td>Full Auto Tuning</td> <td>7.0 s or longer</td> <td></td> </tr> <tr> <td>Position Tuning</td> <td>3.0 s or shorter</td> <td>3.0 s or longer</td> </tr> </tbody> </table>		First point	Second point	2-point Tuning	3.0 s or shorter	3.0 s or shorter	Maximum Sensitivity Tuning	3.0 s or longer		Full Auto Tuning	7.0 s or longer		Position Tuning	3.0 s or shorter	3.0 s or longer
	First point	Second point														
2-point Tuning	3.0 s or shorter	3.0 s or shorter														
Maximum Sensitivity Tuning	3.0 s or longer															
Full Auto Tuning	7.0 s or longer															
Position Tuning	3.0 s or shorter	3.0 s or longer														
13. Inverted Display 	Mounting Amplifier in Inverted Direction Inverts the display upside down. The digital display shows the threshold value in white, and light incident level in green.															
14. Eco Function 	Saving Power Consumption Indicators (Green and white digital displays) turn OFF in approx. 10 seconds after a key operation.															
15. Hysteresis width 	Changing the Hysteresis Width The hysteresis width is set to a default value. The hysteresis width is set so that the judgement output is stable near the threshold value. Be sure to check the stability of outputs as there is a possibility of chattering. Press [MODE] button with [HYS-] displayed and then set the hysteresis width with [UP/DOWN] button. (0 to 9999)															
16. Using the External Input to Write to EEPROM 	Turning ON and OFF Writing to EEPROM The settings that have been changed by an external input with [OFF] will not be overwritten to prevent EEPROM from reaching its lifespan (1,000,000 writings).															

Function Setting	Description						
17. Checking a Margin Against Threshold 	<table border="1"> <thead> <tr> <th>Threshold</th> <th>Light Level Ratio</th> <th>Description</th> </tr> </thead> <tbody> <tr> <td>2000</td> <td>1500</td> <td>The ratio of the incident light level to the threshold is displayed in white digital figures.</td> </tr> </tbody> </table>	Threshold	Light Level Ratio	Description	2000	1500	The ratio of the incident light level to the threshold is displayed in white digital figures.
Threshold	Light Level Ratio	Description					
2000	1500	The ratio of the incident light level to the threshold is displayed in white digital figures.					
18. Setting Threshold using a Small or Fast Moving Workpiece 	<table border="1"> <thead> <tr> <th>Peak Light Level</th> <th>Bottom Light Level</th> <th>Description</th> </tr> </thead> <tbody> <tr> <td>2000</td> <td>2000</td> <td>Holds and displays the minimum value of the peak of the light incident and the maximum value of the bottom of the light interruption.</td> </tr> </tbody> </table>	Peak Light Level	Bottom Light Level	Description	2000	2000	Holds and displays the minimum value of the peak of the light incident and the maximum value of the bottom of the light interruption.
Peak Light Level	Bottom Light Level	Description					
2000	2000	Holds and displays the minimum value of the peak of the light incident and the maximum value of the bottom of the light interruption.					
19. Setting for Intuitive Analog Display 	<table border="1"> <thead> <tr> <th>Threshold</th> <th>Description</th> </tr> </thead> <tbody> <tr> <td>120% 100% 80%</td> <td>Displays the current level in the 80 to 120% range against the threshold value (100%).</td> </tr> </tbody> </table>	Threshold	Description	120% 100% 80%	Displays the current level in the 80 to 120% range against the threshold value (100%).		
Threshold	Description						
120% 100% 80%	Displays the current level in the 80 to 120% range against the threshold value (100%).						
20. Adjusting Optical Axis 	<table border="1"> <thead> <tr> <th>Peak Light Level</th> <th>Light Level</th> <th>Description</th> </tr> </thead> <tbody> <tr> <td>2000</td> <td>2000</td> <td>Holds the peak incident light level and displays it in green digital figures.</td> </tr> </tbody> </table>	Peak Light Level	Light Level	Description	2000	2000	Holds the peak incident light level and displays it in green digital figures.
Peak Light Level	Light Level	Description					
2000	2000	Holds the peak incident light level and displays it in green digital figures.					
21. Checking the Channel No. in Group Mounting 	<table border="1"> <thead> <tr> <th>Ch. No.</th> <th>Light Level</th> <th>Description</th> </tr> </thead> <tbody> <tr> <td>1ch</td> <td>2000</td> <td>Checking the Channel No. in Group Mounting.</td> </tr> </tbody> </table>	Ch. No.	Light Level	Description	1ch	2000	Checking the Channel No. in Group Mounting.
Ch. No.	Light Level	Description					
1ch	2000	Checking the Channel No. in Group Mounting.					
22. Determining If the Workpiece Can Be Detected 	<table border="1"> <thead> <tr> <th>passing time</th> <th>incident level</th> <th>Description</th> </tr> </thead> <tbody> <tr> <td>120%</td> <td>50</td> <td>The passing time and difference in incident levels are displayed.</td> </tr> </tbody> </table>	passing time	incident level	Description	120%	50	The passing time and difference in incident levels are displayed.
passing time	incident level	Description					
120%	50	The passing time and difference in incident levels are displayed.					

Fiber Sensing Features

Selection Guide

Fiber Units

Threaded	Standard Installation
Cylindrical	
Flat	Saving Space
Sleeved	
Small Spot	Beam Improvements
High Power	
Narrow view	
BGS	
Retro-reflective	Transparent Objects
Limited-reflective	
Chemical-resistant, Oil-resistant	Environmental Immunity
Bending	
Heat-resistant	
Area Detection	Applications
Liquid-level	
Vacuum	
FPD, Semi, Solar	
Installation Information	

Fiber Amplifiers, Communications Unit, and Accessories

Technical Guide and Precautions

Model Index

Ratings and Specifications

Item	Models	E3NW-ECT	E3NW-DS
Connectable Sensor Amplifier Units	N-Smart Smart Fiber Amplifier Unit: E3NX-FA0 Smart Laser Amplifier: E3NC-LA0 Smart Laser Amplifier Unit (CMOS type): E3NC-SA0		
Power supply voltage	24VDC (20.4 to 26.4 VDC)		
Power and current consumption	2.4 W max. (Not including the power supplied to Sensor.) 100 mA max. (Not including the current supplied to Sensor.)	2 W max. (Not including the power supplied to Sensor.) 80 mA max. (Not including the current supplied to Sensor.)	
Indicators	L/A IN Indicator (Green), L/A OUT Indicator (Green), PWR Indicator (Green), RUN Indicator (Green), ERROR Indicator (Red), and SS (Sensor Status) indicator (Green/Red)	RUN Indicator (Green), and SS (Sensor Status) indicator (Green/Red)	
Vibration resistance (destruction)	10 to 60 Hz with a 0.7-mm double amplitude, 60 to 150 Hz 50 m/s ² for 1.5 hours each in X, Y, and Z directions		
Shock resistance (destruction)	Destruction: 150 m/s ² for 3 times each in X, Y, and Z directions		
Ambient temperature range	Operating: 0 to 55°C, *1 Storage: -30 to 70°C (with no icing or condensation)		
Ambient humidity range	Operating and storage: 25% to 85% (with no condensation)		
Maximum connectable Sensors	30 *2	10	
Maximum connectable Distributed Sensor units	8	—	
Insulation resistance	20 MΩ min. (at 500 VDC)		
Dielectric strength	500 VAC 50/60Hz 1 min		
Mounting method	35-mm DIN track-mounting		
Weight (packed state/unit only)	Approx. 185 g/Approx. 95 g	Approx. 160 g/Approx. 40 g	
Materials	Polycarbonate		
Accessories	Power supply connector, Communications connector, Connector cover, DIN track End Plates and Instruction manual	Power supply/communications connector, Connector cover, DIN track End Plates, Ferrite core and Instruction manual	

*1. Temperature Limitations Based on Number of Connected Amplifier Units:

Groups of 1 or 2 Amplifiers: 0 to 55°C, Groups of 3 to 10 Amplifiers: 0 to 50°C, Groups of 11 to 16 Amplifiers: 0 to 45°C, Groups of 17 to 30 Amplifiers: 0 to 40°C

*2. A maximum total of 30 Sensors can be connected to a Sensor Communications Unit and Distributed Sensor Units.

Communications Specifications

Item	Specifications
Protocol	EtherCAT
Modulation	Baseband
Baud rate	100 Mbps
Physical layer	100Base-TX (IEEE802.3u)
Topology	Daisy chain
Communications media	STP category 5 or higher
Communications distance	100 m max. between nodes
Noise immunity	Compliant with IEC 61000-4-4, 1 kV min.
Node address setting method	Set the decimal rotary switches or software *1
Node address range	000 to 192 *2

*1. The software setting is used when the node address setting switches are set to 0.

*2. The range depend on the EtherCAT master that is used. Refer to the E3NW-ECT EtherCAT Sensor Communications Unit Operation Manual for details.

Threaded

Cylindrical

Flat

Sleeved

Small Spot

High Power

Narrow view

BGS

Retro-reflective

Limited-reflective

Chemical-resistant,
Oil-resistant

Bending

Heat-resistant

Area Detection

Liquid-level

Vacuum

FPD,
Semi,
Solar

Sensor Communications Unit

77-A E3NW-ECT

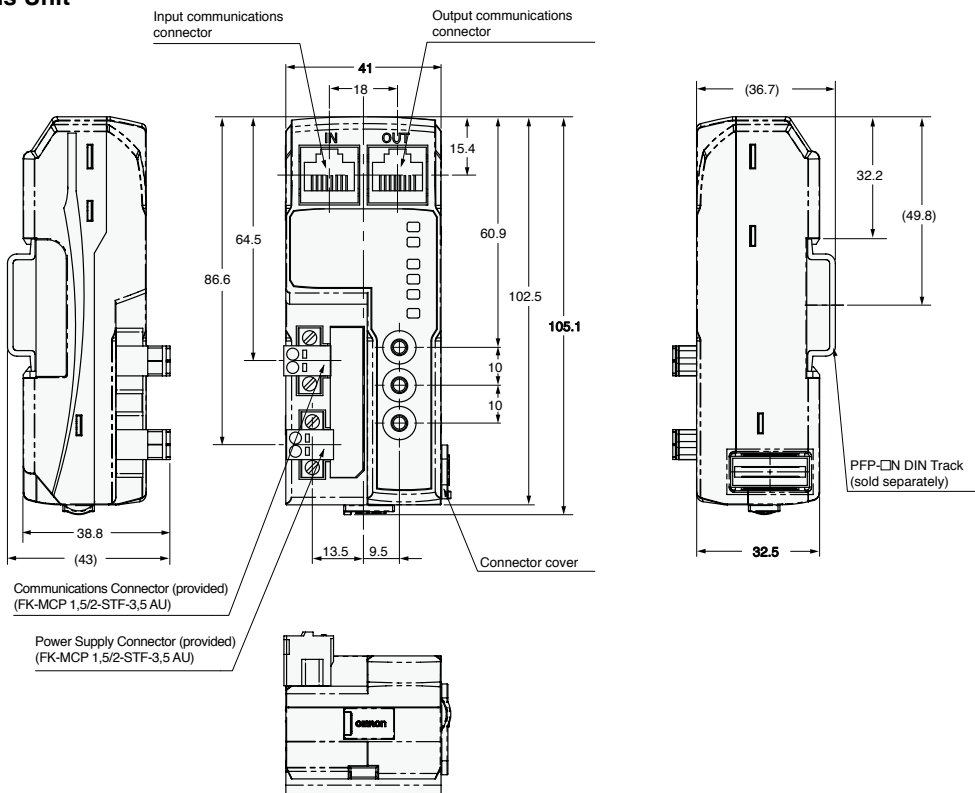

Distributed Sensor Unit

77-B E3NW-DS

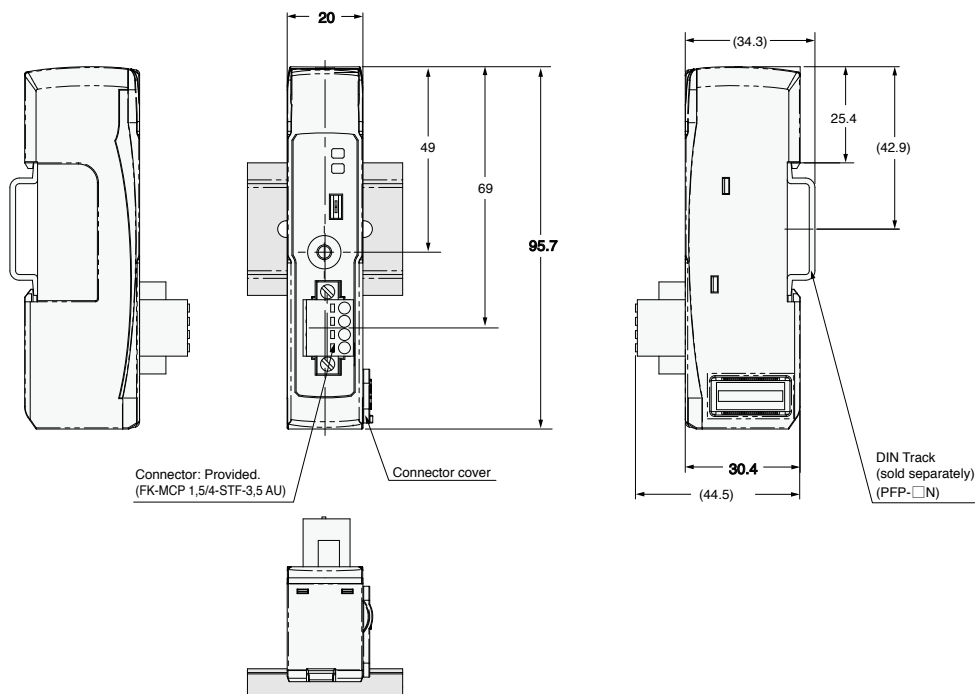

Fiber Sensor Features	
Selection Guide	
Fiber Units	
Threaded	Standard Installation
Cylindrical	
Flat	Saving Space
Sleeved	
Small Spot	Beam Improvements
High Power	
Narrow view	
BGS	
Retro-reflective	Transparent Objects
Limited-reflective	
Chemical-resistant, Oil-resistant	Environmental Immunity
Bending	
Heat-resistant	
Area Detection	Applications
Liquid-level	
Vacuum	
FPD, Semi, Solar	
Installation Information	
Fiber Amplifiers, Communications Unit, and Accessories	
Technical Guide and Precautions	
Model Index	

Threaded

Cylindrical

Flat

Sleeved

Small Spot

High Power

Narrow view

BGS

Retro-reflective

Limited-reflective

Chemical-resistant, Oil-resistant

Bending

Heat-resistant

Area Detection





Liquid-level

Vacuum



FPD, Semi, Solar

E3X-HD Fiber Amplifier Units and Related Products

Fiber Amplifier Units E3X-HD Series



Type	Appearance	Connecting method	Models		Ratings and Specifications	Dimensions
			NPN output	PNP output		
Standard models		Pre-wired (2 m)	E3X-HD11 2M	E3X-HD41 2M	Page 80	Page 80 (80-A)
		Wire-saving Connector	E3X-HD6	E3X-HD8		Page 81 (81-A)
		M8 Connector	E3X-HD14	E3X-HD44		Page 81 (81-B)
Model for Sensor Communications Unit		Connector for Sensor Communications Unit	E3X-HD0			Page 81 (81-C)

Sensor Communications Unit

Communication method	Appearance	Applicable Fiber Amplifier Model	Models	Ratings and Specifications	Dimensions
CompoNet		E3X-HD0 E3X-MDA0 E3X-DA0-S	E3X-CRT	Page 86	Page 87 (87-A)
EtherCAT			E3X-ECT		Page 87 (87-B)



Wire-saving connectors (Required for Wire-saving Connector type models)

Connectors are not provided with the Fiber Amplifier Unit and must be ordered separately. * Protective stickers: provided.

Type	Appearance	Cable length	Number of conductors	Models	Ratings and Specifications	Dimensions
Master Connector		2m	3	E3X-CN11	Page 88	Page 88 (88-A)
Slave Connector			1	E3X-CN12		Page 88 (88-B)

Sensor I/O Connectors (Required for models with M8 Connectors.)

Connectors are not provided with the Fiber Amplifier Unit and must be ordered separately. * Protective stickers: provided.

Appearance	Cable length	Number of conductors	Models	Ratings and Specifications	Dimensions
Straight 	2m	4	XS3F-M421-402-A	Page 88	Page 88 (88-C)
	5m		XS3F-M421-405-A		
L-shaped 	2m		XS3F-M422-402-A		Page 88 (88-D)
	5m		XS3F-M422-405-A		

Mounting Bracket

A Mounting Bracket is not provided with the Fiber Amplifier Unit and must be ordered separately as required.

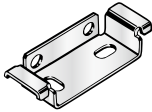
Appearance	Model	Quantity	Dimensions
	E39-L143	1	Page 89 (89-A)

DIN Track

A Din Track is not provided with the Fiber Amplifier Unit and must be ordered separately as required.

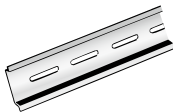
Appearance	Type	Models	Quantity	Dimensions
	Shallow type, total length: 1 m	PFP-100N	1	Page 89 (89-B)
	Shallow type, total length: 0.5 m	PFP-50N		
	Deep type, total length: 1 m	PFP-100N2		Page 89 (89-C)

End Plate

Two End Plates are provided with the Sensor Communications Unit.

End Plates are not provided with the Fiber Amplifier Unit and must be ordered separately as required.

Appearance	Model	Quantity	Dimensions
	PFP-M	1	Page 89 (89-D)

Item	Type	Standard			Model for Sensor Communications Unit *1
	NPN output	E3X-HD11	E3X-HD6	E3X-HD14	E3X-HD0
	PNP output	E3X-HD41	E3X-HD8	E3X-HD44	
	Connecting method	Pre-wired	Wire-saving Connector *2	M8 Connector	Connector for Sensor Communications Unit
Light source (wavelength)		Red, 4-element LED (625 nm)			
Power supply voltage		12 to 24 VDC ±10%, ripple (P-P) 10% max.			
Power consumption		Normal mode: 720 mW max. (Current consumption: 30 mA max. at 24 VDC, 60 mA max. at 12 VDC) Power saving Eco mode: 530 mW max. (Current consumption: 22 mA max. at 24 VDC, 44 mA max. at 12 VDC)			
Control output		Load power supply voltage: 26.4 VDC max., open-collector output (Differs for NPN and PNP outputs.) Load current: 50 mA max. (residual voltage: 2 V max.), OFF current: 0.5 mA max.			—
Protection circuits		Power supply reverse polarity protection, output short-circuit protection and output reverse polarity protection			Power supply reverse polarity protection and output short-circuit protection
Response time	Super-high-speed mode (SHS) *3	NPN outputs: Operate or reset: 50 μs PNP outputs: Operate or reset: 55 μs			—
	High-speed mode (HS)	Operate or reset: 250 μs (default setting)			—
	Standard mode (Std)	Operate or reset: 1 ms			—
	Giga-power mode (GIGA)	Operate or reset: 16 ms			—
Mutual interference prevention		Possible for up to 10 units (optical communications sync) *3			
Auto power control (APC)		Always ON			
Other functions		Power tuning, differential detection, DPC, timer (OFF-delay, ON-delay, or one-shot), zero reset, resetting settings, and Eco mode			
Ambient Illumination (Receiver side)		Incandescent lamp: 20,000 lx max., Sunlight: 30,000 lx max.			
Maximum connectable Units		16 units		with E3X-CRT: 16 units with E3X-ECT: 30 units	
Ambient temperature range		Operating: Groups of 1 to 2 Amplifier Units: -25 to 55°C, Groups of 3 to 10 Amplifier Units: -25 to 50°C, Groups of 11 to 16 Amplifier Units: -25 to 45°C Storage: -30 to 70°C (with no icing or condensation)			Operating: Groups of 1 to 2 Amplifier Units: 0 to 55°C, Groups of 3 to 10 Amplifier Units: 0 to 50°C, Groups of 11 to 16 Amplifier Units: 0 to 45°C, Groups of 17 to 30 Amplifier Units: 0 to 40°C Storage: -30 to 70°C (with no icing or condensation)
Ambient humidity range		Operating and storage: 35% to 85% (with no condensation)			
Insulation resistance		20 MΩ min. (at 500 VDC)			
Dielectric strength		1,000 VAC at 50/60 Hz for 1 min			
Vibration resistance (destruction)		10 to 55 Hz with a 1.5-mm double amplitude for 2 hours each in X, Y, and Z directions		10 to 150 Hz with a 0.7-mm double amplitude for 80 minutes each in X, Y, and Z directions	
Shock resistance (destruction)		500 m/s ² for 3 times each in X, Y, and Z directions			150 m/s ² for 3 times each in X, Y, and Z directions
Degree of protection		IEC 60529 IP50 (with Protective Cover attached)			
Weight (packed state/unit only)		Approx. 105 g/Approx. 65 g	Approx. 60 g/Approx. 20 g	Approx. 70 g/Approx. 25 g	Approx. 65 g/Approx. 25 g
Materials	Case	Heat-resistant ABS			Heat-resistant ABS (connector: PBT)
	Cover	Polycarbonate (PC)			
Accessories		Instruction Manual			

*1. The E3X-ECT EtherCAT Sensor Communications Unit and the E3X-CRT CompoNet Sensor Communications Unit can be used.

*2. Use either the E3X-CN11 (master connector, 3 conductors) or the E3X-CN12 (slave connector, 1 conductor).

*3. The communications function and mutual interference prevention function are disabled when the detection mode is set to Super-high-speed mode (SHS).

When including E3X-DA-S with activated power tuning the maximum number of mutual interference prevention is up to 6.

When including E3X-MDA with activated power tuning the maximum number of mutual interference prevention is up to 5.

Dimensions

Tolerance class IT16 applies to dimensions in this data sheet unless otherwise specified.

(Unit: mm)

Pre-wired Amplifier Units

(80-A) E3X-HD11
E3X-HD41

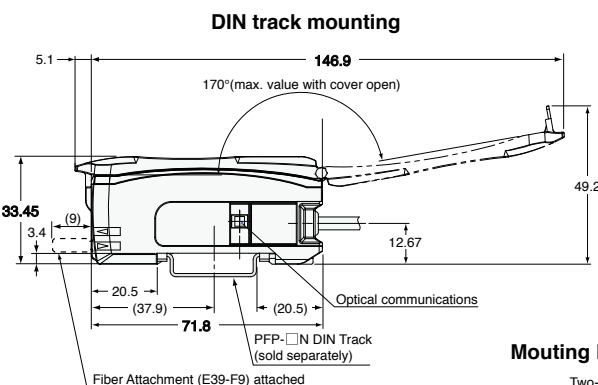
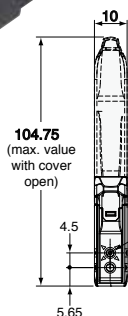
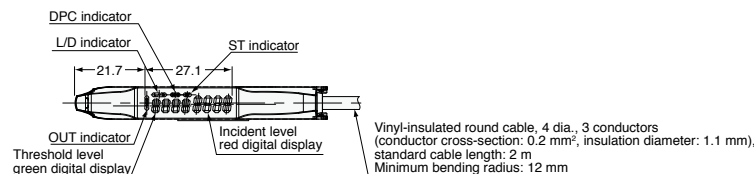

With Mounting Bracket Attached

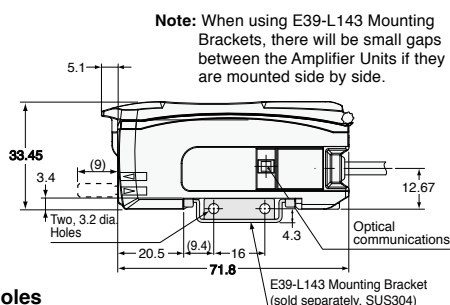

Note: When using E39-L143 Mounting Brackets, there will be small gaps between the Amplifier Units if they are mounted side by side.

Mounting Holes



Amplifier Units with Wire-saving Connectors

81-A E3X-HD6
E3X-HD8

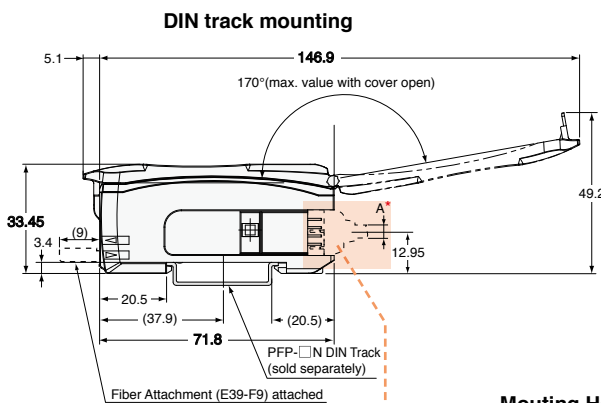
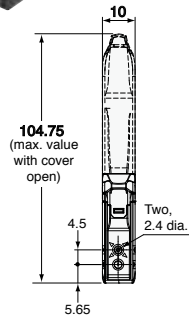
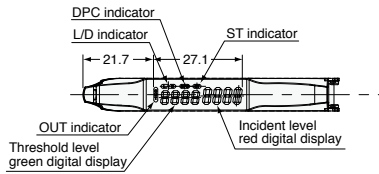

With Mounting Bracket Attached

Note: When using E39-L143 Mounting Brackets, there will be small gaps between the Amplifier Units if they are mounted side by side.

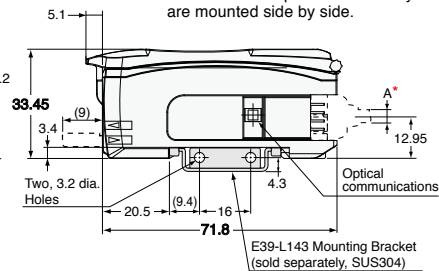

Mounting Holes

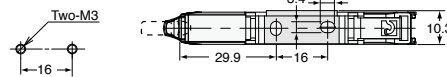

* The cable diameters are as follows:

E3X-CN11 (3 conductors)	4.0 dia.
E3X-CN12 (1 conductor)	2.6 dia.

Amplifier Units with M8 Connectors

81-B E3X-HD14
E3X-HD44

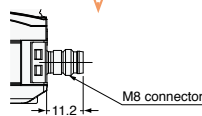

The dimensions are the same as the E3X-HD6/8, except for the connector.

Amplifier Unit with Connector for Sensor Communications Unit

81-C E3X-HD0

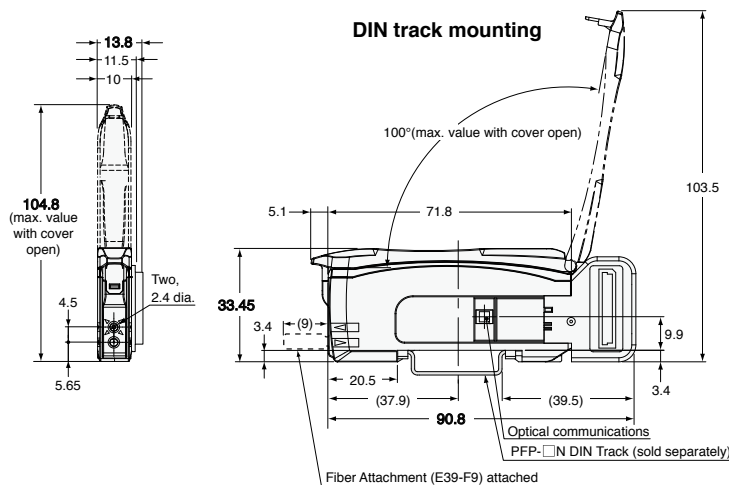
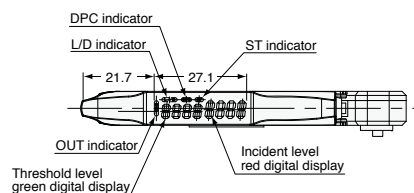

Threaded

Standard Installation

Cylindrical

Flat

Saving Space

Sleeved

Small Spot

High Power

Narrow view

BGS

Beam Improvements

Retro-reflective

Limited-reflective

Transparent Objects

Chemical-resistant, Oil-resistant

Bending

Heat-resistant

Environmental Immunity

Area Detection

Liquid-level

Vacuum

Applications

FPD, Semi, Solar

Installation Information

Fiber Amplifiers, Communications Unit, and Accessories

Technical Guide and Precautions

Model Index

NPN Output

Models	Operation mode	Timing chart	L/D indicators	Output circuit
E3X-HD11 E3X-HD6 E3X-HD14	Light-ON	Incident light: [ON] (High pulse) No incident light: [OFF] (Low) OUT indicator (orange): Lit (High pulse) Not lit: Not lit (Low) Output transistor: ON (High pulse) OFF: OFF (Low) Load: Set (High pulse) Reset: Reset (Low pulse) (Between brown and black leads)	L lit.	
	Dark-ON	Incident light: [OFF] (Low) No incident light: [ON] (High pulse) OUT indicator (orange): Lit (High pulse) Not lit: Not lit (Low) Output transistor: ON (High pulse) OFF: OFF (Low) Load: Set (High pulse) Reset: Reset (Low pulse) (Between brown and black leads)	D lit.	

PNP Output

Models	Operation mode	Timing chart	L/D indicators	Output circuit
E3X-HD41 E3X-HD8 E3X-HD44	Light-ON	Incident light: [ON] (High pulse) No incident light: [OFF] (Low) OUT indicator (orange): Lit (High pulse) Not lit: Not lit (Low) Output transistor: ON (High pulse) OFF: OFF (Low) Load: Set (High pulse) Reset: Reset (Low pulse) (Between blue and black leads)	L lit.	
	Dark-ON	Incident light: [OFF] (Low) No incident light: [ON] (High pulse) OUT indicator (orange): Lit (High pulse) Not lit: Not lit (Low) Output transistor: ON (High pulse) OFF: OFF (Low) Load: Set (High pulse) Reset: Reset (Low pulse) (Between blue and black leads)	D lit.	

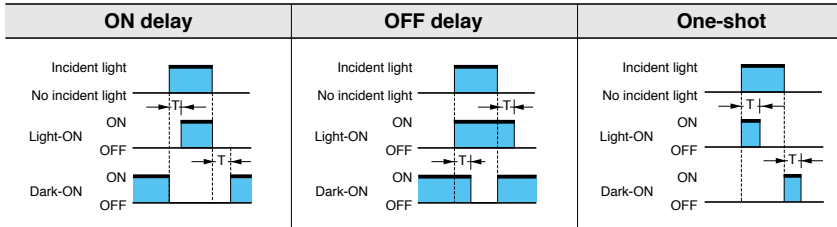

Note: Timing Charts for Timer Settings (T: Set Time)

Nomenclature

- [L/D Indicator]** Indicates the setting status: Light-ON or Dark-ON.
- [DPC Indicator]** Turns ON when Dynamic Power Control is effective.
- [△L/D Button]** Use to switch between Light-ON and Dark-ON.
- [OUT Indicator]** Turns ON when the output is ON.
- [ST Indicator]** Turns ON when Smart Tuning is in progress.
- [TUNE Button]** Automatically sets the emitter power and set values.
- [±UP/DOWN Button]** Used to fine-tune the threshold power and set values.
- [MODE Button]** Use to change Function Settings.
- Threshold Level** Green digital display
- Incident Level** Red digital display

Basic Settings

Switching Control Output

1. Press button.

Through-beam:
Set to "Dark ON" to turn the output ON with a workpiece in the detection area. [L/D Indicator] turns ON.

Reflective:
Set to "Light ON" to turn the output ON with a workpiece in the detection area. [L/D Indicator] turns ON.

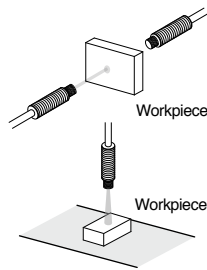

Smart Tuning [Easy Sensitivity Setting]

(1) Detect for Workpiece Presence/Absence

● 2-point Tuning

1. Press button with a workpiece in the detection area.

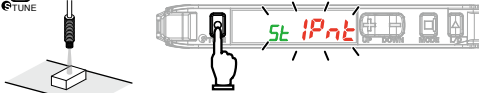

2. Press button again without a workpiece in the detection area.

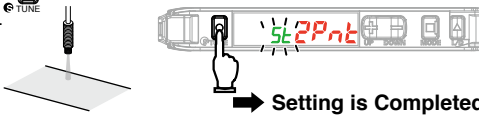

Incident light level setting:
The larger incident level of the Step 1 and 2 values is adjusted to the power tuning level.
Threshold setting: Set to the middle between the Step 1 and 2 incident light levels.

CHECK!
Step 1 and Step 2 can be reversed.

(2) Enhance Durability of the Fiber Head against Dust and Stain

● Maximum Sensitivity Tuning

1. Hold button for 3 seconds or longer with/without workpiece as shown below.
Release the button when is displayed.
Through-beam: Workpiece is present

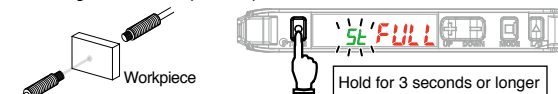

Reflective: Workpiece is absent

Incident light level setting:
The incident level in Step 1 is adjusted to "0".
Threshold setting:
The value is set to approx. 7% of the incident light level of 1.
If the incident light level of 1 is smaller during long distance detection, the minimum value by which an output is correctly turned ON will be set.

(3) Adjust for Moving Workpiece without Stopping Line

● Full Auto Tuning

1. Hold the button without the presence of a workpiece, and pass the workpiece through while → → is displayed in red digital. (Keep holding the button while the workpiece passes through, and hold 7 seconds or longer until is displayed in red digital. After the workpiece passes through, release your finger from the button.)

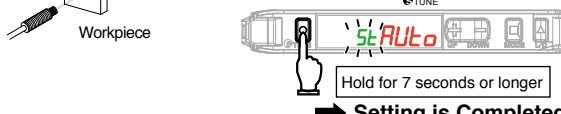

Incident light level setting:
Adjust the max. incident light level on Step 1 as the power tuning level.
Threshold setting:
Set to the middle between max. and min. incident light levels on Step 1.

(4) Determine Workpiece Position

● Position Tuning

1. Press button without a workpiece in the area.

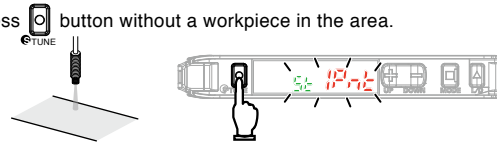

2. Place the workpiece at the desired position and hold button.

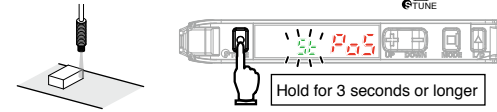

The red digital display changes → .

Incident light level setting:
The Step 2 incident level is adjusted to half the power tuning level.
Threshold setting: Set to the same value as the Step 2 incident level.

(5) Detect Transparent or Small Workpiece (Set Threshold by incident light level percentage)

● Percentage Tuning

1. Turn ON Percentage Tuning in SET mode.

Refer to "Detailed Settings".

2. Press button without a workpiece in the area.

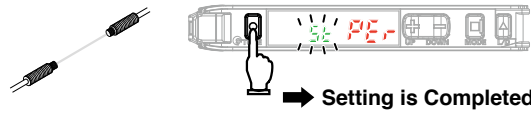

Incident light level setting:
The Step 2 incident light level is adjusted to the power tuning level.
Threshold setting: Set to the value obtained by [Incident Level at Step 2 × Percentage Tuning Level + Incident Level at Step 2].

CHECK!
No Smart Tuning other than Power Tuning can be used if Percentage Tuning is set.

● Smart Tuning Error

Error / Display / Cause	Error Origin Tuning Type	Remedy
Near Error The light level difference between Points 1 and 2 are extremely small.	2-point Tuning Full Auto Tuning Positioning Tuning	<ul style="list-style-type: none"> Change the detection function mode to a slower response time mode. Reduce the distance between the light emitting and light receiving surfaces. (Through-beam) Place the Fiber Head closer to the sensing object. (Reflective)
Over Error Incident light level is too high.	All	<ul style="list-style-type: none"> Enhance the power tuning level. Use a thin-diameter fiber. Widen the emitter and receiver distance (Through-beam) Distance the Fiber Head from the sensing object (Reflective)
Low Error Incident light level is too low.	Tuning other than Maximum Sensitivity Tuning	<ul style="list-style-type: none"> Decrease the power tuning level. Reduce the distance between the light emitting and light receiving surfaces. (Through-beam) Place the Fiber Head closer to the sensing object. (Reflective)

CHECK!
The adjustment range of smart tuning is approx. 20 to 1/100 times. When selecting giga mode as detection function, the range will be approx. 2 to 1/100 times due to the large initial value.

Refer to "Detailed Settings" to change the power tuning level.

Minute Adjustment of Threshold Level

1. Press button to adjust the threshold level.

The threshold level becomes higher. The threshold level becomes lower.



CHECK!
Hold the key for high-speed level adjustment.

(1) Restore from the Incident Level Changed due to Dust and Dirt

● Power Tuning

1. Hold and buttons for 1 second or longer without a workpiece in the area.

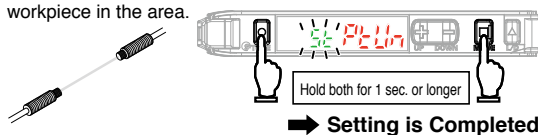

Incident light level setting:
The Step 1 incident level is adjusted to the power tuning level.
Threshold setting:
Not changed. If the value is low, it will be set to the minimum value in which an output is turned ON/OFF correctly.

Perform the procedure with a workpiece in the area for reflective model setting. If the setting is made after position tuning, set both the through-beam model and reflective model with a workpiece.

Refer to "●Smart Tuning Error" for error displays.

(2) Stable Detection Regardless of Incident Level Change due to Dust and Dirt

● DPC Function (Use of the function with Through-beam model or Retro-reflective model is recommended)

1. Perform Smart Tuning.
 Refer to "Smart Tuning"
Refer to "Power Tuning"

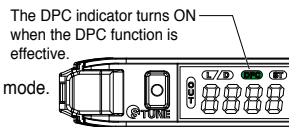

2. Set the DPC function ON in SET mode.
 Refer to "Detailed Settings".

• Steps 1 and 2 can be reversed.
• The DPC function will be disabled when a smart tuning error occurs, differential function with maximum sensitivity tuning is performed, or the first incident light level of the positioning tuning is low.
• The incident light level is corrected to the power tuning level to maintain stable threshold and incident light levels. This provides stable detection regardless of the incident level changes caused by dirty sensor head, position error, or temperature changes.

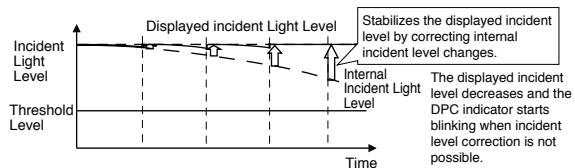

(3) Reset Settings

● Setting Reset

Initializes all the settings by returning them to the factory defaults.

1. Hold and then hold button for 3 seconds or longer.

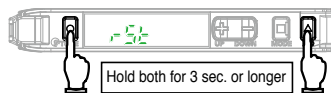

2. Press .
3. Select [] in and press .

Item	Initial Value
Threshold Value	55
Control Output	L-ON

* Settings for other functions are returned to the detailed setting initial values. User-saved settings are retained. Smart Tuning is canceled.

Caution is required; the output is inverted if button is pressed first.

(4) Save or Read Settings

1. Hold and then hold button for 3 seconds or longer.

● User Save Function

Saves the current settings.

2. Select [] in and press .
3. Select [] in and press .

● User Reset Function

Reads out the saved settings.

2. Select [] in and press .
3. Select [] in and press .

Caution is required; the output is inverted if button is pressed first.

(5) Prevent Mistake-operation

● Key Lock Function

Disables all button operations. [] is displayed when the button is pressed.

■ Enable/Cancel (This procedure)

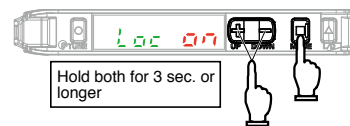

(6) Reset Incident Light Level to "0"

● Zero Reset Function

Changes the incident light level to "0". The threshold level is also shifted accordingly.

■ Enable

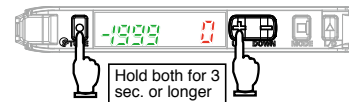

■ Cancel

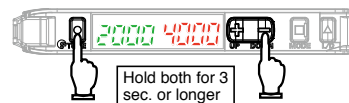

The zero reset function is canceled when either of the DPC function/differential function/Smart Tuning is performed.

Hold **MODE** button for 3 seconds or longer to enter SET mode.

SET mode provides the function settings described hereafter. The initial display shown after transition from one function to another represents the factory default.

Function Setting	Description
------------------	-------------

1. Function Selection

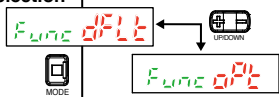

Changing Functions to Set in SET Mode

[dFlt]: Functions 1. to 5. can be set
[dPt]: Functions 1. to 10. can be set.

2. Detection Function

(Incident Light Level Example)

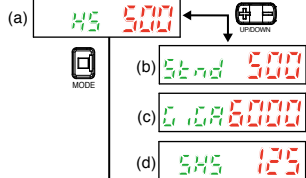

Changing Light Level and Response Time

Detection Function	Response Time	Light Level
(a) HS High-speed mode	250 μs	1 (Standard)
(b) STND Standard mode	1 ms	1 time
(c) GIGA Giga mode	16 ms	12 times
(d) SHS Super-high-speed mode*	NPN 50 μs	0.25 times
	PNP 55 μs	

Smart Tuning is canceled if the detection mode is changed.

* The communication and mutual interference prevention functions are disabled when the detection mode is set to super-high-speed mode.

CHECK! The incident light level in SET mode is a reference value. It may be changed when switched to detection mode.

Stable Detection Regardless of Incident Light Level Change

Refer to "Convenient Setting Features"

3. DPC Function

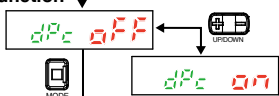

4. Timer Function

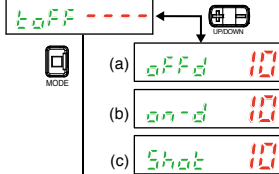

Setting Output Timer

Off-delay Timer	Incident light	No incident light
(a) Holds the output ON for detection by PLC when the detection time is too short.	L-ON ON D-ON OFF	L-ON OFF D-ON OFF
(b) On-delay Timer Delays the output ON after detection.	L-ON ON D-ON OFF	L-ON OFF D-ON OFF
(c) One-shot Timer Keeps the output ON for a specified time regardless of the workpiece size variations.	L-ON ON D-ON OFF	L-ON OFF D-ON OFF

A timer value can be set after pressing **MODE** button when a timer menu (other display than "----") is displayed.

Use **UP/DOWN** button to set the time. (1 to 9999 ms in 1 ms steps; the initial value: 10 ms)

5. Power Tuning Level



Changing the Target Incident Light Level (Power Tuning Level)

Use **UP/DOWN** button to set the power tuning level. [100 to 9999 in 1 steps; the initial value: 9999]

Refer to "Convenient Setting Features"

6. Percentage Tuning



Detecting Transparent or Small Workpiece

Press **MODE** button in [PEr ON] menu, then use **UP/DOWN** button to set the percentage tuning level. (-99% to 99% in 1% steps; the initial value: -10%)

Refer to "Smart Tuning"

Function Setting

Description

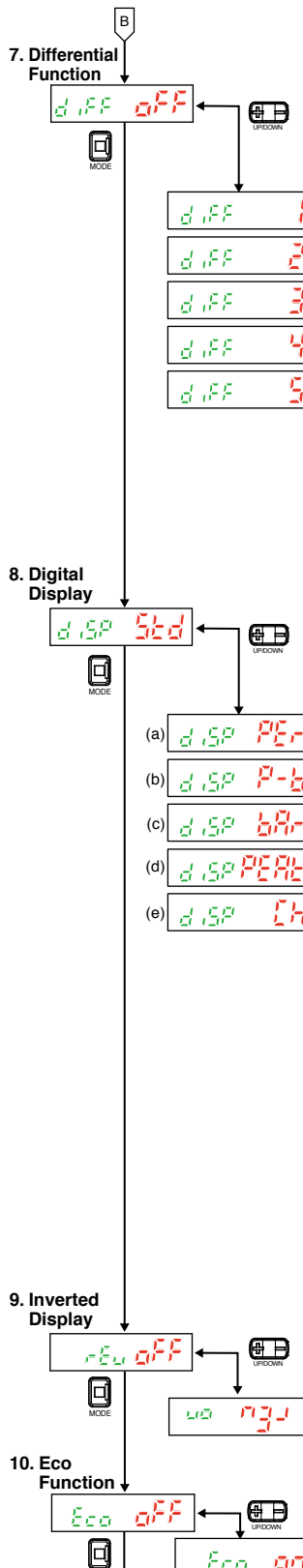

Detecting Incident Light Level Change

Detects if the absolute value of the incident light level change of the set response time is larger than the threshold value. The display shows the change of the incident light level of the set response time in red.

Differential Setting	Response Time
1	250 μs
2	500 μs
3	1 ms
4	10 ms
5	100 ms

Use **UP/DOWN** button to specify the response time. When the differential function is enabled, the detection function setting is disabled. Smart tunings except power tuning are disabled. The adjustment range of power tuning is approx. 1 to 1/100 times.

Changing Digital Display in RUN Mode for Specific Purpose

Checking a Margin Against Threshold

Threshold	Light Level Ratio	The ratio of the incident light level to the threshold is displayed in red digital figures.
2000	1500	(a)

Setting Threshold using a Small or Fast Moving Workpiece

Peak Light Level	Bottom Light Level	Holds and displays the minimum value of the peak of the light incident and the maximum value of the bottom of the light interruption.
8000	2000	(b)

Setting for Intuitive Analog Display

Threshold	Displays the current level in the 80 to 120% range against the threshold value (100%).
120% 100% 80%	(c)

Adjusting Optical Axis

Peak Light Level	Light Level	Holds the peak incident light level and displays it in green digital figures.
3500	2000	(d)

Checking the Channel No. in Group Mounting

Ch. No.	Light Level	Checking the Channel No. in Group Mounting.
124	2000	(e)

Mounting Amplifier in Inverted Direction

Inverts the display upside down. The digital display shows the threshold value in red, and light incident level in green.

Saving Power Consumption

Indicators (Green and Red digital displays) turn OFF in approx. 10 seconds after a key operation.

Standard Installation
Threaded
Cylindrical

Saving Space
Flat
Sleeved

Beam Improvements
Small Spot
High Power
Narrow view
BGS

Transparent Objects
Retro-reflective
Limited-reflective

Environmental Immunity
Chemical-resistant, Oil-resistant
Bending
Heat-resistant

Applications
Area Detection
Liquid-level
Vacuum
FPD, Semi, Solar

Ratings and Specifications

E3X-CRT

Item	Specifications
Communication method	CompoNet Communications
Connectable Sensors	Fiber Sensors: E3X-HD0, E3X-MDA0 and E3X-DA0-S Laser Sensor Head with Separate Digital Amplifier: E3C-LDA0 Proximity Sensor with Separate Amplifier: E2C-EDA0
Communications power supply voltage	14 to 26.4 VDC (Communications Unit draws power from the communications power supply.)
Power and current consumption	2.4 W max. (Not including the power supplied to Sensor.) 100 mA max. at 24 VDC (Not including the current supplied to Sensor.)
Functions	I/O communications, message communications, and Sensor error output
Indicators	MS Indicator (Green/Red), NS indicator (Green/Red), and SS (Sensor Status) indicator (Green/Red)
Vibration resistance	10 to 150 Hz with double amplitude of 0.7 mm, or 50 m/s ² 80 min each in X, Y, and Z directions
Shock resistance	150 m/s ² 3 times each in X, Y, and Z directions
Dielectric strength	500 VAC 50/60Hz 1 min
Insulation resistance	20MΩ min.
Ambient operating temperature	0 to 55°C (with no icing or condensation) * The temperature is limited by the number of connected Fiber Amplifier Units.
Ambient operating humidity	25% to 85% (with no icing or condensation)
Storage temperature	-30 to 70°C (with no icing or condensation)
Storage humidity	25% to 85% (with no condensation)
Mounting method	35-mm DIN track-mounting
Weight (packed state/unit only)	Approx. 220 g/Approx. 95 g
Accessories	Connector cover, DIN track End Plates and Instruction manual

Note. The E3X-CRT has two operating modes: I/O mode 1 and I/O mode 2. The following table gives the differences between these modes.

	I/O classification	Number of allocated points	Maximum number of interconnected
I/O mode 1	Input Unit	Input: 32	15
I/O mode 2	I/O Unit	Input: 64 Output: 64	16

* Temperature Limitations Based on Number of Connected Fiber Amplifier Units:
Groups of 1 to 2 Amplifier Units: 0 to 55°C,
Groups of 3 to 10 Amplifier Units: 0 to 50°C,
Groups of 11 to 16 Amplifier Units: 0 to 45°C

Read the User's Manual for precautions on using this Unit. (E412)

E3X-ECT

Item	Specifications
Communication method	EtherCAT
Connectable Sensors	Fiber Sensor: E3X-HD0, E3X-MDA0 and E3X-DA0-S Laser Sensor Head with Separate Digital Amplifier: E3C-LDA0 Proximity Sensor with Separate Amplifier: E2C-EDA0
Power supply voltage	20.4 to 26.4 VDC
Power and current consumption	2.4 W max. (Not including power the supplied to Sensor.) 100 mA max. at 24 VDC (Not including the current supplied to Sensor.)
Functions	DC (synchronous) mode, Free run mode, PDO communications,* 1 SDO communications, Sensor error output
Indicators	L/A IN indicator (Yellow), L/A OUT indicator (Yellow), PWR indicator (Green), RUN indicator (Green), ERROR indicator (Red), and SS (Sensor Status) indicator (Green/Red)
Vibration resistance	10 to 150 Hz with double amplitude of 0.7 mm, or 50 m/s ² 80 min each in X, Y, and Z directions
Shock resistance	150 m/s ² 3 times each in X, Y, and Z directions
Dielectric strength	500 VAC 50/60 Hz 1 min
Insulation resistance	20MΩ min.
Ambient operating temperature	0 to 55°C (with no icing or condensation) * The temperature is limited by the number of connected Fiber Amplifier Units.
Ambient operating humidity	25% to 85% (with no condensation)
Storage temperature	-30 to 70°C (with no icing or condensation)
Storage humidity	25% to 85% (with no condensation)
Mounting method	35-mm DIN track-mounting
Weight (packed state/unit only)	Approx. 220 g/Approx. 95 g
Accessories	Power supply connector, connector cover, DIN track End Plates and Instruction manual

- *1. Data Size Assignable to the PDO (Process Data Object):
There is a maximum data size that can be assigned. The maximum size is 36 bytes.
- *2. Temperature Limitations Based on Number of Connected Fiber Amplifier Units:
Groups of 1 to 2 Amplifier Units: 0 to 55°C,
Groups of 3 to 10 Amplifier Units: 0 to 50°C,
Groups of 11 to 16 Amplifier Units: 0 to 45°C,
Groups of 17 to 30 Amplifier Units: 0 to 40°C

Read the User's Manual for precautions on using this Unit. (E413)

Threaded

Cylindrical

Flat

Sleeved

Small Spot

High Power

Narrow view

BGS

Retro-reflective

Limited-reflective

Chemical-resistant, Oil-resistant

Bending

Heat-resistant

Area Detection

Liquid-level

Vacuum

FPD, Semi, Solar

Dimensions

Tolerance class IT16 applies to demmensions in this date sheet unless otherwise specified. (Unit: mm)

87-A E3X-CRT

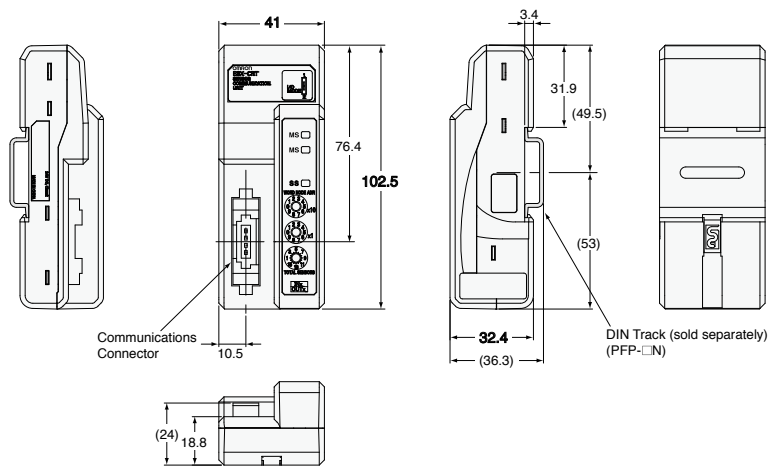

87-B E3X-ECT

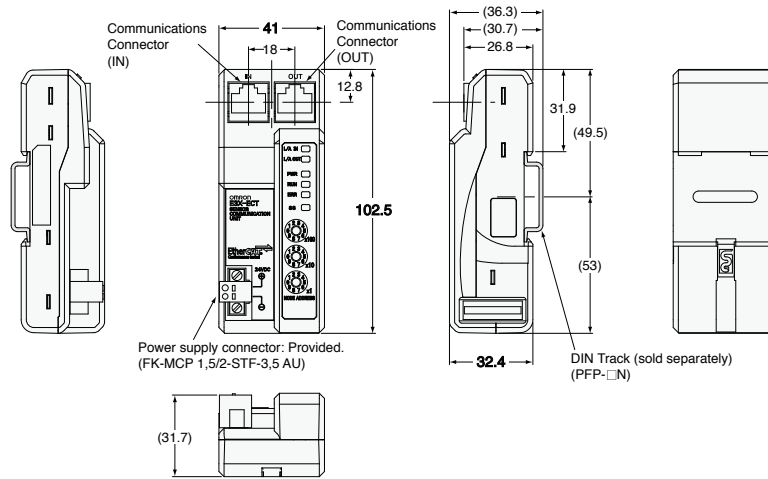

Fiber Sensors Features	
Selection Guide	
Fiber Units	
Threaded	Standard Installation
Cylindrical	
Flat	Saving Space
Sleeved	
Small Spot	Beam Improvements
High Power	
Narrow view	
BGS	
Retro-reflective	Transparent Objects
Limited-reflective	
Chemical-resistant, Oil-resistant	Environmental Immunity
Bending	
Heat-resistant	
Area Detection	Applications
Liquid-level	
Vacuum	
FPD, Semi, Solar	
Installation Information	

Fiber Amplifiers, Communications Unit, and Accessories

Technical Guide and Precautions

Model Index

Wire-saving Connectors

Item	Type	Master Connector		Slave Connector	
	Models	E3X-CN21	E3X-CN11	E3X-CN22	E3X-CN12
Number of conductors		4	3	2	1
Diameter of cable		4 dia.			2.6 dia.
Rated current		2.5A			
Rated voltage		50VDC			
Contact resistance		20 mΩ max. (20 mVDC max., 100 mA max.) (The above figure is for connection to the Amplifier Unit and the adjacent Connector. It does not include the conductor resistance of the cable.)			
Number of insertions		Destruction: 50 times (for connection to the Amplifier Unit and the adjacent Connector)			
Material	Housing	Polybutylene terephthalate (PBT)			
	Contact	Phosphor bronze/gold-plated nickel			
Weight (packed state)		Approx. 55 g			Approx. 25 g

Sensor I/O Connectors

Item	Models	XS3F-M42□-40□-A
Number of conductors		4
Diameter of cable		4 dia.
Rated current		1A
Rated voltage		125VDC
Contact resistance		40 mΩ max. (20 mVDC max., 100 mA max.)
Number of insertions		Destruction: 200 times

Dimensions

(Unit: mm)
Tolerance class IT16 applies to demmensions in this date sheet unless otherwise specified.

Wire-saving Connectors (for Models with Wire-saving Connectors)

Master Connector

(88-A) E3X-CN21
E3X-CN11

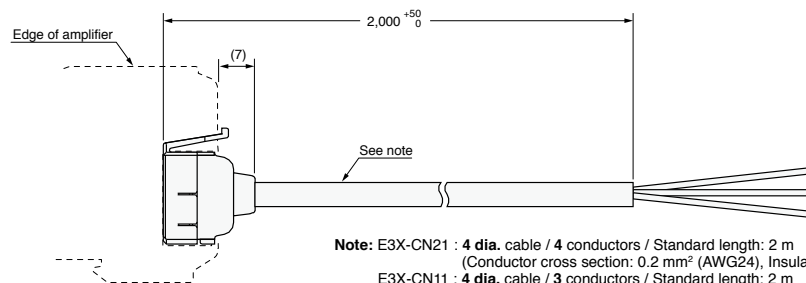

Note: E3X-CN21 : 4 dia. cable / 4 conductors / Standard length: 2 m
(Conductor cross section: 0.2 mm² (AWG24), Insulator diameter: 1.1 mm)
E3X-CN11 : 4 dia. cable / 3 conductors / Standard length: 2 m
(Conductor cross section: 0.2 mm² (AWG24), Insulator diameter: 1.1 mm)

Slave Connector

(88-B) E3X-CN22
E3X-CN12

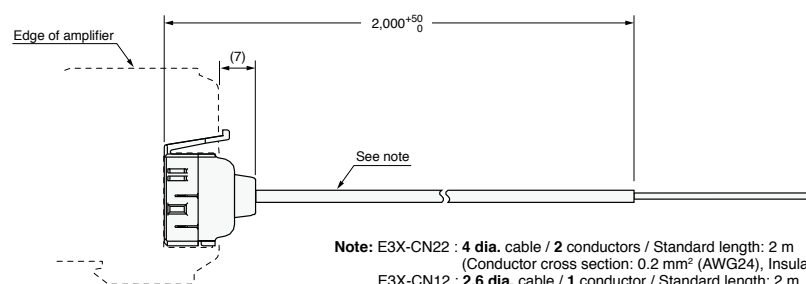

Note: E3X-CN22 : 4 dia. cable / 2 conductors / Standard length: 2 m
(Conductor cross section: 0.2 mm² (AWG24), Insulator diameter: 1.1 mm)
E3X-CN12 : 2.6 dia. cable / 1 conductor / Standard length: 2 m
(Conductor cross section: 0.2 mm² (AWG24), Insulator diameter: 1.1 mm)

Sensor I/O Connectors (for Models with M8 Connectors)

(88-C) XS3F-M421-402-A
XS3F-M421-405-A

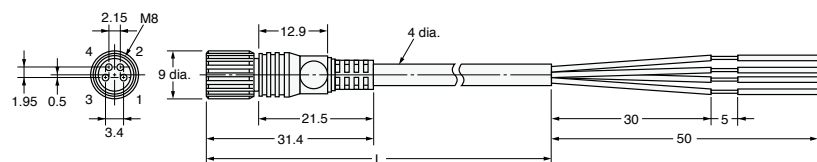

(88-D) XS3F-M422-402-A
XS3F-M422-405-A

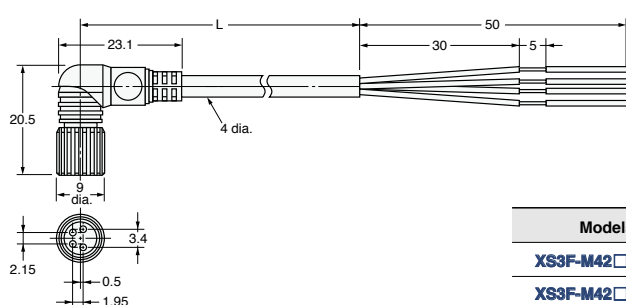

Models	Cable length L (m)
XS3F-M42□-402-A	2
XS3F-M42□-405-A	5

Threaded
Cylindrical

Flat
Sleeved

Small Spot
High Power
Narrow view
BGS

Retro-reflective
Limited-reflective

Chemical-resistant, Oil-resistant
Bending
Heat-resistant

Area Detection
Liquid-level
Vacuum

89-A E39-L143

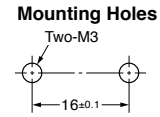
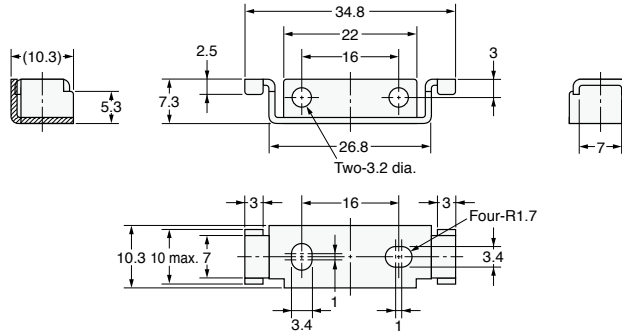
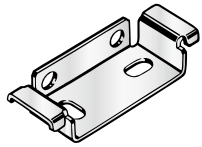

Material: Stainless steel (SUS304)

DIN track

89-B PFP-100N PFP-50N

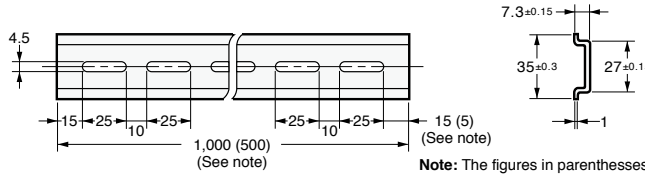
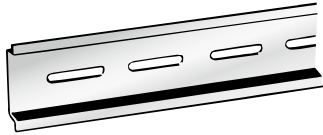

Note: The figures in parentheses are for the PFP-50N.

Material: Aluminum

89-C PFP-100N2

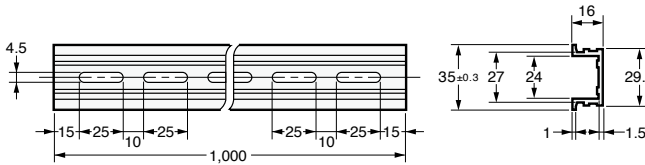
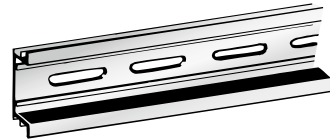

Material: Aluminum

End Plate

89-D PFP-M

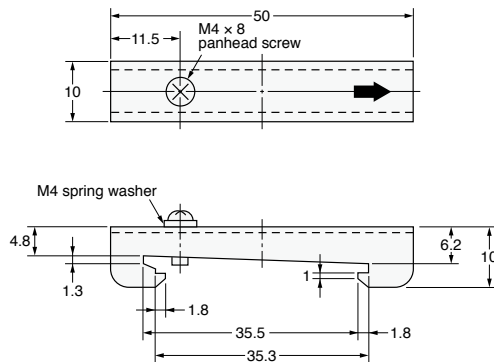
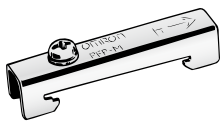

Material: Iron, zinc plating

Threaded	Standard Installation
Cylindrical	
Flat	Saving Space
Sleeved	
Small Spot	Beam Improvements
High Power	
Narrow view	
BGS	
Retro-reflective	Transparent Objects
Limited-reflective	
Chemical-resistant, Oil-resistant	Environmental Immunity
Bending	
Heat-resistant	
Area Detection	Applications
Liquid-level	
Vacuum	
FPD, Semi, Solar	
Installation Information	

Influence of Fiber Cable Length

The sensing distance listed in the Fiber Units specifications are based on the fiber cable lengths found in the suffix of the model number. The sensing distance will change if the fiber cable is cut or extended.

The following graph shows the percentage change of the various fiber cable length, where 100% is the sensing distance for a fiber cable with a length of 2 m.

Use this as a guideline for installation distances.

Keep in mind that extending the cable with a fiber connector will result in even shorter sensing distances than the value given in the graph.

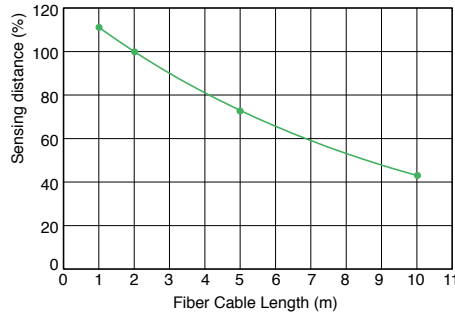

* The 100% value is for a fiber cable with a length of 2 m (same for Through-beam and Reflective Models).

Reflective Models: Sensing Distance Ratios by Workpiece Materials

The following graph shows the percentage change of the various workpieces, where 100% is the sensing distance for white paper, the standard sensing object.

Refer to the value of the material that looks like your workpiece.

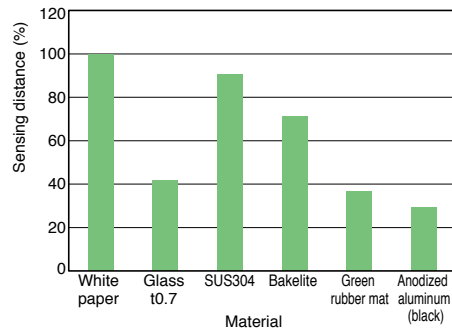

* White paper is 100%.

Types of Fiber Cables

This section describes the features of different types of fiber cables.

(This is given in the Fiber Unit specifications as either Flexible or Bend-resistant for the cable bending radius, and Coaxial for the appearance.)

If no definition is given, a standard cable is used.)

• Flexible Fibers

The flexible fiber has a small bending radius for easy routing without fiber damage. Flexible fibers are not intended for applications with repeated bends.

It improves sensing performance because the cable can be bent without significantly reducing light intensity.

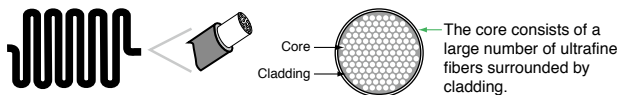

• Bend-resistant Fibers

This fiber is resistant to repeated bends for use on moving parts. A common application is a robotic arm.

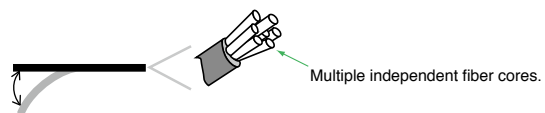

• Standard Fibers

This fiber have a large bending radius compared with bend-resistant or flexible fiber.

Use this fiber where the bending radius is large, or on non-moving parts.

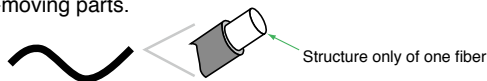

• Coaxial Reflective Fibers

These fibers are suitable for sensing small objects at close range. They also detect glossy surfaces more reliably than Standard Reflective fibers, even if the surface is tilted. The receiver fibers are arranged around the emitter fiber, as shown below.

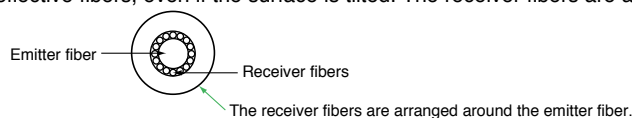

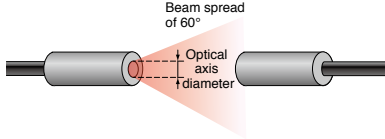
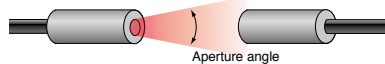
Category	Question	Answer
Fiber Units	How do I interpret the optical axis diameter in the Fiber Unit specifications?	<p>The optical axis diameter is the beam size that the Through-beam Fiber Unit uses for detection.</p> <p>If you are detecting objects larger than the optical axis diameter, you can expect stable detection performance because the object will block all of the beams of light that are used for detection.</p> <p>The incident level may fluctuate, however, if the workpiece passes the beam at high speed.</p> <p>In this case, it is best to select a Fiber Unit with a smaller optical axis diameter, or change the response time of the Fiber Amplifier Unit to High-speed mode or to Super-high-speed mode setting.</p> 
	Are there any differences between the Fiber Units that are used for emitter and receiver?	<p>With Through-beam Fiber Units, there is no difference between emitter fibers and receiver fibers.</p> <p>With Reflective Fiber Units, the emitter fibers and receiver fibers are different on Coaxial Reflective Models.</p> <p>Emitter fiber cables have identification marks. Refer to the individual dimensions diagrams of Fiber Units for details.</p>
	What size must the hole be to mount a Threaded or Cylindrical Fiber Unit?	Refer to the recommended mounting hole dimensions given on pages 58 to 61.
	Are Fiber Cables available in different lengths?	Some models are available with either 5-m or 10-m cable. Ask your OMRON representative for details.
	What is the aperture angle?	<p>The aperture angle is the angle at which the emitter beam spreads out.</p> 
	Are these Fiber Units CE certified?	Fiber Units do not have any electrical components and therefore are exempt from CE certification.
	Can these Fiber Units be used in explosionproof areas?	The Fiber Units can be used in an explosion-proof area. Install only the Fiber Unit in the explosion-proof area and install the Fiber Amplifier Unit outside the explosion-proof area.
Fiber Amplifier Units	Can the Fiber Amplifier Units be linked with other models?	The E3X-HD Series can be connected only with the E3X-DA-S and MDA Series.
	Can the Fiber Amplifier Unit be operated from a mobile console?	Mobile consoles cannot be used with either the E3NX-FA Series or the E3X-HD Series.
	Can a Sensor Communications Unit be used?	<p>If you use E3NX-FA0 Amplifier Units, you can use the E3NW-ECT(EtherCAT), E3NW-CRT(CompoNet) or E3NW-CCL (CC-Link).</p> <p>If you use E3X-HD0 Amplifier Units, you can use the E3X-CRT (CompoNet) or E3X-ECT (EtherCAT).</p>

Fiber Amplifier Unit

Warning

This product is not designed or rated for ensuring safety of persons either directly or indirectly.
Do not use it for such purposes.



Do not use the product with voltage in excess of the rated voltage.
Excess voltage may result in malfunction or fire.



Never use the product with AC power supply.
Otherwise, explosion may result.



Precautions for Safe Use

The following precautions must be observed to ensure safe operation of the product. Doing so may cause damage or fire.

- (1) Do not install the product in the following locations.
 - Locations subject to direct sunlight
 - Locations subject to condensation due to high humidity
 - Locations subject to corrosive gas
 - Locations subject to vibration or mechanical shocks exceeding the rated values
 - Locations subject to exposure to water, oil, chemicals
 - Locations subject to stream
 - Locations subjected to strong magnetic field or electric field
- (2) Do not use the product in environments subject to flammable or explosive gases.
- (3) Do not use the product in any atmosphere or environment that exceeds the ratings.
- (4) To secure the safety of operation and maintenance, do not install the product close to high-voltage devices and power devices.
- (5) High-Voltage lines and power lines must be wired separately from this product. Wiring them together or placing them in the same duct may cause induction, resulting in malfunction or damage.
- (6) Do not apply load exceeding the ratings. Otherwise, damage or fire may result.
- (7) Do not short the load. Otherwise, damage or fire may result.
- (8) Do not use the product if the case is damaged.
- (9) Burn injury may occur. The product surface temperature rises depending on application conditions, such as the ambient temperature and the power supply voltage. Use caution when operating or cleaning the product.
- (10) When setting the Sensor, be sure to check safety, such as by stopping the equipment.
- (11) Be sure to turn off the power supply before connecting or disconnecting wires.
- (12) Do not attempt to disassemble, repair, or modify the product Unit in any way.
- (13) When disposing of the product, treat it as industrial waste.

Precautions for Correct Use

- (1) Connect the load correctly.
- (2) Do not miswire such as the polarity of the power supply.
- (3) Be sure to mount the unit to the DIN track until it clicks.
- (4) When using Amplifier Units with Wire-saving Connectors, attach the protective stickers (provided with E3X-CN-series Connectors) on the unused power pins to prevent electrical shock and short circuiting. When using Amplifier Units with Connectors for Communications Units, attach the protective caps.

Amplifier Unit with Wire-saving Connector

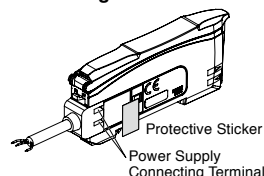

Amplifier Unit with Connector for Communications Unit

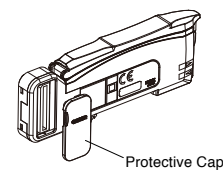

- (5) Use an extension cable with a minimum thickness of 0.3 mm² and less than 100 m long.
- (6) Do not apply the forces on the cord exceeding the following limits: Pull: 40N; torque: 0.1N·m; pressure: 20N; bending: 29.4N
- (7) Do not apply excessive force (9.8 N max.) such as tension, compression or torsion to the Amplifier Unit with the Fiber Unit fixed to the Amplifier Unit.
- (8) Always keep the protective cover in place when using the Amplifier Unit. Not doing so may cause malfunction.
- (9) It may take time until the received light intensity and measured value become stable immediately after the power is turned on depending on use environment.
- (10) The product is ready to operate 200 ms after the power supply is turned ON.
- (11) The Mobile Console E3X-MC11, E3X-MC11-SV2 and E3X-MC11-S cannot be connected.
- (12) Mutual interference prevention on the E3NX-FA Series does not function among the E3X-HD, E3X-DA-S, E3X-DA-N, E3X-SD, or E3X-NA Fiber Amplifier Units. Mutual interference prevention on the E3X-HD Series does not function among the E3NX-FA, E3X-DA-N, E3X-SD, or E3X-NA Fiber Amplifier Units. Mutual interference prevention on the E3X-HD Series does function among the E3X-DA-S and E3X-MDA Fiber Amplifier Units.
- (13) If the unit receives excessive sensor light, the mutual interference prevention function may not work properly, resulting in malfunction of the unit. In such case, increase the threshold.
- (14) The E3NW-ECT Sensor Communications Unit can be used with the E3NX-FA0, but the E3X-DRT21-S, E3X-CRT, and E3X-ECT Sensor Communications Units cannot be used. The E3X-CRT and E3X-ECT Sensor Communications Unit can be used with the E3X-HD0, but the E3X-DRT21-S and E3NW-ECT Sensor Communications Units cannot be used.
- (15) If you notice an abnormal condition such as a strange odor, extreme heating of the unit, or smoke immediately stop using the product, turn off the power, and consult your dealer.
- (16) Do not use thinner, benzene, acetone, and lamp oil for cleaning.

Threaded

Cylindrical

Flat

Sleeved

Small Spot

High Power

Narrow view

BGS

Retro-reflective

Limited-reflective

Chemical-resistant, Oil-resistant

Bending

Heat-resistant

Area Detection

Liquid-level

Vacuum

FPD, Semi, Solar

Mounting the Fiber Amplifier Units

■ Mounting on DIN Track

- Let the hook on the Amplifier Unit's Fiber Unit connection side catch the track and push the unit until it clicks.

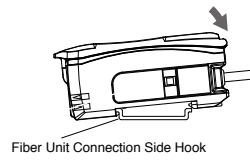

■ Removing from DIN Track

- Push the unit in the direction 1.
- Lift it up in the direction 2.

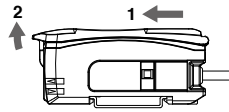

Refer to "I/O Circuit Diagrams" or check the side of the unit for wire color and role indications.

■ Mounting Amplifier Units in Group (Connector Type Models)

- Mount the Fiber Amplifier units one at a time onto the DIN track and push them until they click.
- Slide the Fiber Amplifier units in the direction 2.
- Use End Plates (FPF-M: separately sold) at the both ends of the grouped Fiber Amplifier units to prevent them from separating due to vibration or other cause.
- Tighten the screw on the End Plates using a driver.

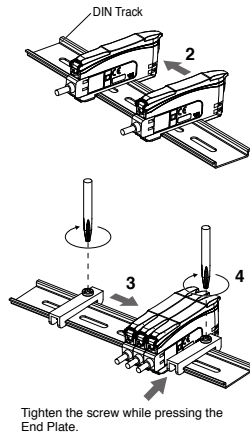

- Under environments such as vibration, use an end plates even with a single Fiber Amplifier Unit.
- The maximum numbers of connectable Amplifier Units are given in the following table.

	Maximum number of interconnected	Maximum number of mutual interference prevention
E3NX-FA series*	30	10
E3X-HD series standard models* (E3X-HD11/HD41/HD6/HD8)	16	10
E3X-HD0	With E3X-ECT	30
	With E3X-CRT	16

- If Units are to be connected, the ambient temperature will change with the number of Units that are connected. Check the Ratings and Characteristics specifications.
- Always turn OFF the power before connecting or disconnecting Units.
- * The mutual interference prevention function cannot be used if the detection mode is set to super-high-speed mode (SHS).

Mounting Fiber Units

■ Use Fiber Cutter

Cut a thin fiber as follows.
For standard fibers, insert to the desired cutting position and cut.

(1)	The fiber is shipped loosely tightened as shown in the figure at the right	
(2)	Adjust the fiber to the desired length and fully tighten.	
(3)	Insert the Fiber Unit into E39-F4 and cut it.	
(4)	Finished state. (Correctly cut end)	

■ Mount Fiber Unit

- Open the protective cover.
- Raise the lock lever.
- Insert the Fiber Unit in the fiber unit hole to the bottom.
- Return the lock lever to the original position and fix the Fiber Unit.

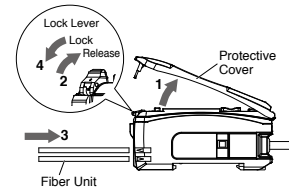

- When mounting a coaxial reflective Fiber Unit, insert the single-core Fiber Unit to the upper hole (Emitter side) and the multi-core Fiber Unit to the lower hole (Receiver side). The cables for the Single-core Fiber Units (Emitters) have identification marks. Refer to the dimensions diagrams for details.
- When removing the Fiber Unit, follow the above steps in reverse order. To maintain the characteristics of the Fiber Unit, make sure the lock is released before removing the Fiber Unit.

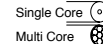

Threaded

Cylindrical

Flat

Sleeved

Small Spot

High Power

Narrow view

BGS

Retro-reflective

Limited-reflective

Chemical-resistant, Oil-resistant

Bending

Heat-resistant

Area Detection

Liquid-level

Vacuum

FPD, Semi, Solar

Warning

This product is not designed or rated for ensuring safety of persons either directly or indirectly. Do not use it for such purposes.



Precautions for Correct Use

Do not use the Fiber Unit in atmospheres or environments that exceed product ratings.

Mounting

Tightening Force

Refer to pages 56 to 59 for the tightening torque to apply when mounting a Fiber Unit.

<Threaded Models>

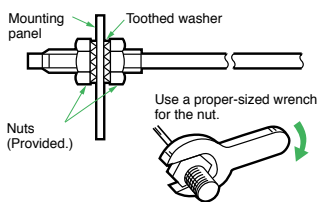

<Cylindrical Models>

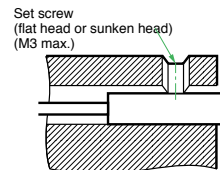

<Chemical and Oil-resistant Models>

The following method is recommended for mounting Fiber Units with fluororesin-covered sensing heads (E32-T□F and E32-D□F) to prevent from cracking the fluororesin case.

If you use a set screw to secure the Fiber Unit, tighten it with care to prevent from cracking the case.

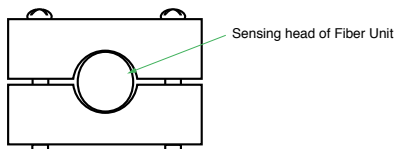

Connections

- Do not subject the Fiber Unit to excessive force, such as tension or compression. Refer to pages 56 to 59 for tensile strengths.
- Make sure any bend in the Fiber Unit is larger than the allowable bending radius. Refer to pages 56 to 59 for bending radius ratings and length of unbendable sections at the base of the Fiber Unit.
- Do not compress or place heavy loads on the fibers.



- The method shown below is an effective way to prevent the Fiber Unit from breaking due to vibration.

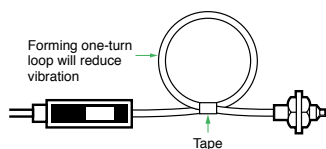

Sleeve Bender (E39-F11)

- The bending radius of the stainless steel tube should be as large as possible. The smaller the bending radius is, the shorter the sensing distance will be.
- Insert the tip of the stainless steel tube in the Sleeve Bender and slowly bend the tube along the curve of the Sleeve Bender.

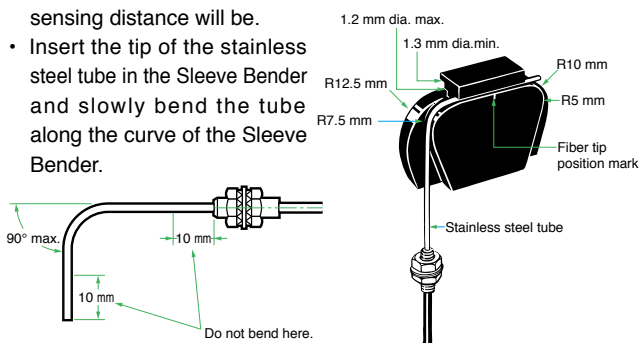

Heat-resistant Fiber Units (E32-D51(R) and E32-T51(R))

The fibers of these Units cannot be extended using the E39-F10 Fiber Connector.

E32-T14

These Units may enter the light-ON state if there are reflective objects at the end of the lenses.

If reflection is a problem, attach the black stickers provided to the ends of the lenses.

E32-T16PR

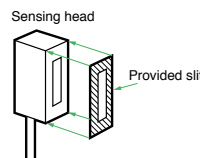

To use the provided slit, peel off the backing sheet, align the slit with the edges of the sensing surface, and attach it to the sensing head.

Use the slit in applications where saturation occurs (i.e., changes in incident level cannot be detected) due to short sensing distances.

Vacuum-resistant Fiber Units (E32-□V)

Although the Flanges, the Fiber Units on the vacuum side, and the Lens Units have been cleaned, as an extra precaution, clean these with alcohol before using them in high-vacuum environments to ensure that they are properly degreased.

Liquid-level Detection Fiber Unit (E32-D82F1)

- Secure the Fiber Unit using the unbendable section. Otherwise, the liquid-level detection position may be displaced.
- For applications in hazardous environments, install the Fiber Unit in the hazardous environment but install the Amplifier Unit in a safe environment.

Liquid-level Detection Fiber Units (Tube-mounting Models)

- Make sure that the tube is not deformed when using a band to secure the Fiber Unit.

● Adjustment

Detection Position for Liquid-level Detection Fiber Unit (E32-D82F1)

The liquid-level detection position is 5.2 ± 2 mm from the end of the fluoro-resin section. (Refer to the diagram on the right.)

The liquid-level detection position varies with the surface tension of the liquid and the degree of wetness at the Fiber Unit's detection position.

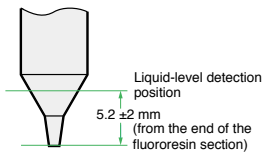

● Other Precautions

Liquid-level Detection Fiber Unit (E32-D82F1)

- Operation may become unstable in the following cases:
 1. Bubbles stick to the cone of the sensing head.
 2. Solute deposits on the cone of the sensing head.
 3. The liquid has a high viscosity.
- There are some liquids, such as milky white liquids, for which detection is not possible.
- Do not let the end of the fluoro-resin section bump into other objects.

Damage to or deformation of the sensing head may cause unstable operation.

Chemical and Oil-resistant, Liquid-level Detection Fiber Unit (E32-D82F1)

Fluoro-resin shows strong chemical-resistant properties but is permeable if exposed to atmospheres with gaseous chemicals or water vapors, resulting in failure or damage.

Confirm applicability sufficiently before using the Fiber Unit in these environments.

Accessories

Use of E39-R3 Reflector Provided with E32-R21

1. Use detergent to remove any dust or oil from the surfaces where tape is applied. Adhesive tape will not be attached properly if oil or dust remains on the surface.
2. The E39-R3 cannot be used in areas that are exposed to oil or chemicals.

Mounting method of Protective Spiral Tubes

1. Insert the Fiber Unit into the Protective Spiral Tube from the head connector (threaded).

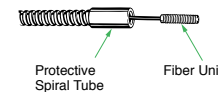

2. Push the fiber into the Protective Spiral Tube. The tube must be straight so that the fiber enters without twisting. Turn the Protective Spiral Tube, not the fiber.

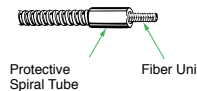

3. Secure the Protective Spiral Tube to the mounting panel with the provided nuts.

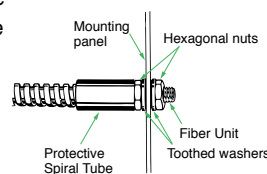

4. Use the provided saddle to secure the end cap of the Protective Spiral Tube.

(To secure the Protective Spiral Tube at a position other than the end cap, apply tape to the tube so that the portion becomes thicker in diameter.)

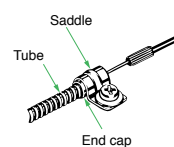

Attaching the E39-F10 Fiber Connector

Attach the Fiber Connector as shown in the following figures.

1. Insert the Fiber Unit in the retention clip.
2. Insert the retention clip into the splice.

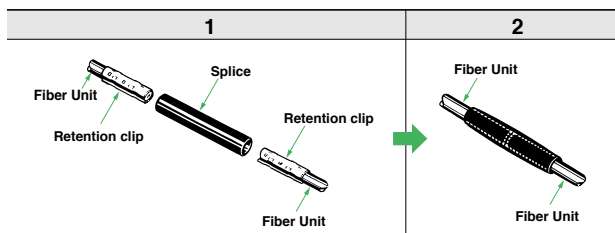

- The Fiber Units should be as close as possible when they are connected. The sensing distance is reduced by approximately 25% when Fiber Units are extended by the connector.
- Only 2.2-mm-diameter fibers can be connected.

Models	Specifications	Dimensions
E32-A		
E32-A01 5M	P.50	P.51 (51-A)
E32-A03 2M	P.30	P.31 (31-A)
	P.56	P.57 (57-A)
E32-A03-1 2M	P.30	P.31 (31-B)
	P.56	P.57 (57-B)
E32-A04 2M	P.30	P.31 (31-C)
	P.56	P.57 (57-C)
E32-A08 2M	P.36	P.37 (37-C)
	P.54	P.55 (55-B)
E32-A08H2 2M	P.46	P.47 (47-D)
	P.54	P.55 (55-C)
E32-A09 2M	P.36	P.37 (37-F)
	P.54	P.55 (55-E)
E32-A09H2 2M	P.46	P.47 (47-E)
	P.54	P.55 (55-F)
E32-A12 2M	P.36	P.37 (37-D)
	P.54	P.55 (55-D)
E32-C		
E32-C11N 2M	P.08 (P.22)	P.09 (P.23) (09-B)
E32-C31 2M	P.08 (P.20, 22, 34)	P.09 (P.21, 23, 35) (09-D)
	P.08	P.09 (09-E)
E32-C31M 1M	P.08	P.09 (09-E)
E32-C31N 2M	P.08 (P.20, 22)	P.09 (P.21, 23) (09-A)
	P.08	P.09 (09-A)
E32-C41 1M	P.22	P.23 (23-A)
		(23-D)
E32-C42 1M	P.20	P.21 (21-A)
		(21-B)
E32-C42S 1M	P.20	P.21 (21-E)
		(21-B)
E32-CC200 2M	P.08 (P.22)	P.09 (P.23) (09-H)
		(09-H)
E32-D		
E32-D11 2M	P.42	P.43 (43-E)
E32-D11R 2M	P.08	P.09 (09-G)
E32-D11U 2M	P.38	P.39 (39-I)
E32-D12F 2M	P.38	P.39 (39-H)
E32-D15XR 2M	P.14	P.15 (15-D)
E32-D15YR 2M	P.14	P.15 (15-E)
E32-D15ZR 2M	P.14	P.15 (15-F)
E32-D16 2M	P.24	P.25 (25-D)
E32-D21 2M	P.42	P.43 (43-B)
E32-D211R 2M	P.08	P.09 (09-F)
E32-D21B 2M	P.42	P.43 (43-D)
E32-D21R 2M	P.08	P.09 (09-C)
E32-D21-S3 2M	P.18	P.19 (19-J)
E32-D221B 2M	P.12	P.13 (13-D)
	P.42	P.43 (43-C)
E32-D22B 2M	P.12	P.13 (13-A)
	P.42	P.43 (43-A)
E32-D22R 2M	P.12	P.13 (13-C)
E32-D22-S1 2M	P.18	P.19 (19-I)
E32-D24R 2M	P.18	P.19 (19-A)
E32-D24-S2 2M	P.18	P.19 (19-B)
E32-D25XB 2M	P.42	P.43 (43-F)
E32-D25-S3 2M	P.18	P.19 (19-L)
E32-D31-S1 0.5M	P.18	P.19 (19-G)
E32-D32L 2M	P.12	P.13 (13-E)
E32-D32-S1 0.5M	P.18	P.19 (19-F)
E32-D33 2M	P.12	P.13 (13-F)
	P.18	P.19 (19-E)
E32-D331 2M	P.18	P.19 (19-D)
E32-D36P1 2M	P.48	P.49 (49-D)

Models	Specifications	Dimensions
E32-D36T 2M	P.50	P.51 (51-C)
E32-D43M 1M	P.12	P.13 (13-B)
	P.18	P.19 (19-C)
E32-D51 2M	P.46	P.47 (47-B)
E32-D51R 2M	P.46	P.47 (47-A)
E32-D61-S 2M	P.46	P.47 (47-G)
E32-D611-S 2M	P.46	P.47 (47-F)
E32-D73-S 2M	P.46	P.47 (47-H)
E32-D81R-S 2M	P.46	P.47 (47-C)
E32-D82F1 4M	P.50	P.51 (51-D)
E32-DC200BR 2M	P.18	P.19 (19-K)
E32-DC200F4R 2M	P.18	P.19 (19-H)
E32-L		
E32-L11FP 2M	P.38	P.39 (39-F)
	P.54	P.55 (55-G)
E32-L11FS 2M	P.38	P.39 (39-G)
	P.54	P.55 (55-H)
E32-L15 2M	P.20	P.21 (21-F)
E32-L16-N 2M	P.32	P.33 (33-A)
	P.36	P.37 (37-B)
	P.54	P.55 (55-A)
E32-L24S 2M	P.32	P.33 (33-B)
	P.36	P.37 (37-A)
E32-L25L 2M	P.32	P.33 (33-C)
	P.36	P.37 (37-E)
E32-L25T 2M	P.50	P.51 (51-B)
E32-LD11 2M	P.08	P.09 (09-I)
E32-LD11R 2M		
E32-LT11 2M	P.06	P.07 (07-C)
	P.24	P.25 (25-B)
E32-LT11R 2M	P.06	P.07 (07-C)
	P.24	P.25 (25-B)
E32-R		
E32-R16 2M	P.34	P.35 (35-B)
E32-R21 2M	P.34	P.35 (35-C)
E32-T		
E32-T10V 2M	P.52	P.53 (53-D)
E32-T11 2M	P.40 (P.26)	P.41 (P.27) (41-C)
		(41-C)
E32-T11F 2M	P.38	P.39 (39-C)
E32-T11N 2M	P.06 (P.26)	P.07 (P.27) (07-A)
E32-T11NF 2M	P.38	P.39 (39-A)
E32-T11R 2M	P.06 (P.24)	P.07 (P.25, 26) (07-B)
E32-T12F 2M	P.38	P.39 (39-B)
E32-T12R 2M	P.10	P.11 (11-C)
E32-T14 2M	P.24	P.25 (25-C)
E32-T14F 2M	P.38	P.39 (39-D)
E32-T14LR 2M	P.10	P.11 (11-D)
E32-T15XR 2M	P.14	P.15 (15-A)
E32-T15YR 2M	P.14	P.15 (15-B)
E32-T15ZR 2M	P.14	P.15 (15-C)
E32-T16JR 2M	P.48	P.49 (49-B)
E32-T16PR 2M	P.48	P.49 (49-A)
E32-T16WR 2M	P.48	P.49 (49-C)
E32-T17L 10M	P.24	P.25 (25-A)
E32-T21 2M	P.40	P.41 (41-B)
E32-T21-S1 2M	P.16	P.17 (17-D)
E32-T223R 2M	P.10	P.11 (11-A)
E32-T22B 2M	P.10	P.11 (11-B)
	P.40	P.41 (41-A)
E32-T22S 2M	P.30	P.31 (31-F)
E32-T24E 2M	P.16	P.17 (17-B)

Models	Specifications	Dimensions
E32-T24R 2M	P.16	P.17 (17-A)
E32-T24S 2M	P.30	P.31 (31-E)
	P.56	P.57 (57-E)
E32-T24SR 2M	P.30	P.31 (31-D)
	P.56	P.57 (57-D)
E32-T25XB 2M	P.40	P.41 (41-D)
E32-T33 1M	P.16	P.17 (17-C)
E32-T51 2M	P.44 (P.28)	P.45 (P.29) (45-B)
		(45-B)
E32-T51F 2M	P.38	P.39 (39-E)
E32-T51R 2M	P.44 (P.28)	P.45 (P.29) (45-A)
		(45-A)
E32-T51V 1M	P.52	P.53 (53-A)
E32-T61-S 2M	P.44 (P.28)	P.45 (P.29) (45-D)
		(45-D)
E32-T81R-S 2M	P.44 (P.28)	P.45 (P.29) (45-C)
		(45-C)
E32-T84SV 1M	P.52	P.53 (53-C)
E32-TC200BR 2M	P.16	P.17 (17-E)
E32-V		
E32-VF1	P.52	P.53 (53-F)
E32-VF4	P.52	P.53 (53-E)
E39-F		
E39-F1	P.26, 28	P.26 (26-A)
E39-F1-33	P.28	P.28 (28-D)
E39-F11	P.17	—
E39-F16	P.26, 28	P.26 (26-B)
E39-F17	P.20	P.21 (21-B)
E39-F18	P.22	P.23 (23-G)
		(23-H)
E39-F1V	P.52	P.53 (53-B)
E39-F2	P.26, 28	P.26 (26-C)
		(26-C)
E39-F32A	P.42	P.43 (43-G)
E39-F32C	P.40	P.41 (41-E)
	P.42	P.43 (43-G)
E39-F32D	P.42	P.43 (43-G)
E39-F3A	P.20	P.21 (21-A)
E39-F3A-5	P.22	P.23 (23-A)
		(23-B)
		(23-C)
E39-F3B	P.22	P.23 (23-D)
		(23-E)
		(23-F)
E39-F3C	P.20	P.21 (21-C)
		(21-D)
E39-F3R	P.34	P.35 (35-A)
E39-R		
E39-R1	—	P.35 (35-B)
E39-R3	—	P.35 (35-C)
E39-RP37	P.34	P.35 (35-A)
E39-L		
E39-L143	—	P.89 (89-A)
E3NW		
E3NW-DS	P.76	P.77 (77-B)
E3NW-ECT	P.76	P.77 (77-A)
E3NX-FA		
E3NX-FA0	P.66	P.69 (69-B)
E3NX-FA11 2M	P.66	P.68 (68-A)
E3NX-FA21 2M	P.66	P.68 (68-A)
E3NX-FA24	P.66	P.69 (68-A)
E3NX-FA41 2M	P.66	P.68 (68-A)
E3NX-FA51 2M	P.66	P.68 (68-A)
E3NX-FA54	P.66	P.69 (68-A)
E3NX-FA54TW	P.66	P.69 (68-A)

Models	Specifications	Dimensions
E3NX-FA6	P.66	P.68 (68-B)
E3NX-FA7	P.66	P.68 (68-B)
E3NX-FA7TW	P.66	P.68 (68-B)
E3NX-FA8	P.66	P.68 (68-B)
E3NX-FA9	P.66	P.68 (68-B)
E3NX-FA9TW	P.66	P.68 (68-B)
E3X-CN		
E3X-CN11	P.88	P.88 (88-A)
E3X-CN12	P.88	P.88 (88-B)
E3X-CN21	P.88	P.88 (88-A)
E3X-CN22	P.88	P.88 (88-B)
E3X-CRT		
E3X-CRT	P.86	P.87 (87-A)
E3X-ECT		
E3X-ECT	P.86	P.87 (87-B)
E3X-HD		
E3X-HD0	P.80	P.81 (81-C)
E3X-HD11 2M	P.80	P.80 (80-A)
E3X-HD14	P.80	P.81 (81-B)
E3X-HD41 2M	P.80	P.80 (80-A)
E3X-HD44	P.80	P.81 (81-B)
E3X-HD6	P.80	P.81 (81-A)
E3X-HD8	P.80	P.81 (81-A)
PPF		
PPF-100N	—	P.89 (89-B)
PPF-100N2	—	P.89 (89-C)
PPF-50N	—	P.89 (89-B)
PPF-M	—	P.89 (89-D)
XS3F		
XS3F-M421-402-A	P.88	P.88 (88-C)
XS3F-M421-405-A	P.88	P.88 (88-C)
XS3F-M422-402-A	P.88	P.88 (88-D)
XS3F-M422-405-A	P.88	P.88 (88-D)

The N-Smart Lineup

E3NX-FA
Fiber Amplifier Units

N-Smart Amplifier Units
Easy application with consistent operating procedures.

E3NC-S
Ultra-compact CMOS
Laser Sensors

E3NC-L
Compact
Laser Sensors

E3NW
Sensor
Communications Units

EtherCAT

N-Smart
Presence / Detection / Measurement

Applications with Many Sensors:
More convenience and even lower costs with a network.

Introducing New Fiber Sensor Products

LENS IN Fiber Units E32-LT/LD

→ Page 06, 08



High-power, Stable Detection
Is the Standard for the Future!

Sleeve Fiber Units E32-□-S□

→ Page 16, 18

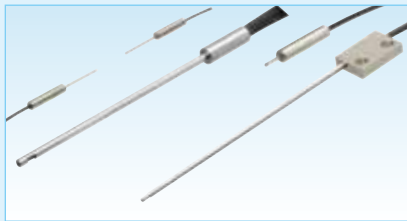

New Shapes of Sleeve Fiber Units
Allow for Detection at Locations
Separated from the Installation Position

Fiber Amplifier Units E3NX-FA

→ Page 62



A New Level of Detection Performance for
More-stable Equipment Operation

OMRON AUTOMATION AND SAFETY • THE AMERICAS HEADQUARTERS

Schaumburg, IL USA • 847.843.7900 • 800.556.6766 • www.omron247.com

OMRON CANADA, INC. • HEAD OFFICE

Toronto, ON, Canada • 416.286.6465 • 866.986.6766 • www.omron247.com

OMRON ELECTRONICS DE MEXICO • HEAD OFFICE

México DF • 52.55.59.01.43.00 • 001.800.556.6766 • mela@omron.com

OMRON ELECTRONICS DE MEXICO • SALES OFFICE

Apodaca, N.L. • 52.81.11.56.99.20 • 001.800.556.6766 • mela@omron.com

OMRON ELETRÔNICA DO BRASIL LTDA • HEAD OFFICE

São Paulo, SP, Brasil • 55.11.2101.6300 • www.omron.com.br

OMRON ARGENTINA • SALES OFFICE

Cono Sur • 54.11.4783.5300

OMRON CHILE • SALES OFFICE

Santiago • 56.9.9917.3920

OTHER OMRON LATIN AMERICA SALES

54.11.4783.5300

OMRON EUROPE B.V. • Wegalaan 67-69, NL-2132 JD, Hoofddorp, The Netherlands.

+31 (0) 23 568 13 00 • www.industrial.omron.eu

Authorized Distributor:

Automation Control Systems

- Machine Automation Controllers (MAC) • Programmable Controllers (PLC)
- Operator interfaces (HMI) • Distributed I/O • Software

Drives & Motion Controls

- Servo & AC Drives • Motion Controllers & Encoders

Temperature & Process Controllers

- Single and Multi-loop Controllers

Sensors & Vision

- Proximity Sensors • Photoelectric Sensors • Fiber-Optic Sensors
- Amplified Photomicrosensors • Measurement Sensors
- Ultrasonic Sensors • Vision Sensors • RFID/Code Readers

Industrial Components

- Relays • Pushbuttons & Indicators • Limit and Basic Switches • Timers
- Counters • Metering Devices • Power Supplies

Safety

- Laser Scanners • Safety Mats • Edges and Bumpers
- Programmable Safety Controllers • Light Curtains • Safety Relays
- Safety Interlock Switches

X-ON Electronics

Largest Supplier of Electrical and Electronic Components

Click to view similar products for [Fiber Optic Sensors](#) category:

Click to view products by [Omron](#) manufacturer:

Other Similar products are found below :

[F04MA03123](#) [E32L56E1](#) [E32L56E2](#) [E32-L25T](#) [E32-T21L](#) [E32-T14 5M](#) [E32-CC200R](#) [E32-T16 5M](#) [E32-D15Z 2M](#) [E32-D15XR 2M](#) [E32-T25ZR 2M](#) [E32-T22R 2M](#) [E32-L11FP 2M](#) [E32-LD11 2M](#) [E32-DC200FR](#) [E32-L12FS 2M](#) [E32-D61 5M](#) [E32-A08 2M](#) [E32-D61-S 5M](#) [E32-T22SR 2M](#) [E32-LD11N 2M](#) [E32-L12FS 5M](#) [E32-T16P 5M](#) [E32-L11FS 5M](#) [E32-D11 10M](#) [E32-J1R 20M](#) [E32-T12L 5M](#) [E32-D21N 2M](#) [E32-LT11 2M](#) [E32-D21N 5M](#) [E32-TC300](#) [E32-TC200C](#) [E32-T61-S 5M](#) [E32-T51V 1M](#) [E32-T33-S5 1M](#) [E32-T25XB 2M](#) [E32-T24 5M](#) [E32-T15XR 2M](#) [E32-T11 5M](#) [E32-LT11R2M](#) [E32-L11FS 2M](#) [E32-L11FP 5M](#) [E32-ETS24R 2M](#) [E32-DC200BR](#) [E32-D36T 2M](#) [E32-D25Z 2M](#) [E32-D11R 5M](#) [CCS-NFCB3](#) [CCS-NFCB2-3](#) [E32-DC200F4R](#)