

Temperature Sensor E52

CSM_E52_DS_E_7_1

A Wide Variety of High-precision Temperature Sensors









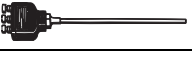
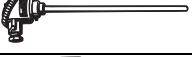

- Ideal for the thermal input devices of Temperature Controllers.
- Select from a wide variety of Temperature Sensors according to the temperature to be measured, location, and environment, and also according to the type and shape of the terminal.
- General-purpose, low-cost, and exclusive models are available.

 Refer to *Safety Precautions for All Temperature Controllers*.

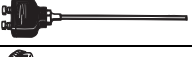
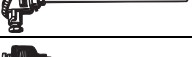

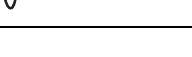

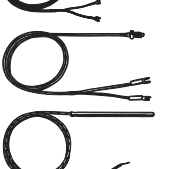



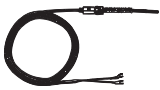
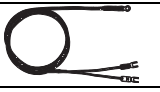

Ordering Information

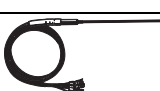
List of Models

Classification	Description	Model and appearance	Temperature range (See note 3.)	Element type	Conductor type	Class	Protective tubing material	Terminal type	Page	
General-purpose Models	Sheathed platinum resistance thermometer	E52-P□A 	-200°C to 450°C	Pt100	3-conductor system	B	SUS316	Exposed lead wires	5	
		E52-P□C 						Enclosed terminals	6	
		E52-P□B 						Exposed terminals	6	
		E52-P□C 						Enclosed terminals	7	
	Sheathed thermocouple	E52-CA□A E52-IC□A 	0°C to 1,050°C	K (CA) J (IC)	Non-grounded type	2 (0.75)	SUS316	Exposed lead wires	9	
								E52-CA□B E52-IC□B 	Exposed terminals	13
									E52-CA□C E52-IC□C 	Enclosed terminals
		Standard thermocouple	E52-CA□B E52-IC□B 	0°C to 1,000°C			SUS316 SUS310S	Exposed terminals		14
								E52-CA□C E52-IC□C 	Enclosed terminals	15
			E52-PR□C 	0°C to 1,400°C	R (PR)		2 (0.25)	JIS ceramic JIS special ceramic	Enclosed terminals	16
Low-cost Models	Low-cost platinum resistance thermometer	E52-P10AE E52-P6D E52-P6F 	-50°C to 250°C	Pt100	3-conductor system	B	SUS304	Exposed lead wires	17	
		E52-CA□AS E52-IC□AS 	0°C to 400°C	K (CA) J (IC)	Non-grounded type	2 (0.75)		Exposed terminals	18	
	E52-CA1D E52-IC1D E52-CA6F E52-IC6F E52-CA6D E52-IC6D 							Grounded type	19	
								E52-CA10AE E52-IC10AE 	Non-grounded type	21

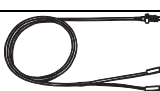
- Note:**
1. Exclusive models are provided on the following page.
 2. These tables provide general specifications only. Be sure to read the detailed specifications and precautions before use.
 3. The temperature range varies with the material, thickness, and construction of the protective tubing.

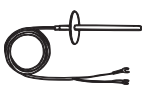
Classification	Description	Model and appearance	Temperature range (See note 3.)	Element type	Conductor type	Class	Protective tubing material	Terminal type	Page
Exclusive Models	Bayonet spring for molding machines	E52-CA2GV E52-IC2GV 	0°C to 350°C	K (CA) J (IC)	Grounded type	2 (0.75)	SUS304	Exposed lead wires	21
	Crimping terminals	E52-CA1GT E52-IC1GT 	0°C to 300°C						22
	Used for measuring surface temperatures	E52-P2GS 	-50°C to 250°C	Pt100	3-conductor system	B		22	
	Used for room temperature measurement	E52-P10GR 	-50°C to 60°C					22	
	Double-element model	E52-P20GW 	-50°C to 250°C					Two 3-conductor systems	23
	Waterproof model	E52-P10GP 	0°C to 70°C					3-conductor system	23
		E52-P5A-40 	-50°C to 180°C						Fluororesin molding
	Corrosion-resistant model	E52-□□A-1 	-80°C to 180°C					Pt100	3-conductor system
				K (CA)	Non-grounded type	2 (0.75)		27	
	Silicone-covered lead wires	E52-CA1D-40 	0°C to 300°C	K (CA)	Grounded type	2 (0.75)		---	27
Explosion-proof model	E52-□□C-6 	-100°C to 500°C	Pt100	3-conductor system	B	SUS316	Enclosed terminals	25	
		-100°C to 900°C	K (CA)	Non-grounded type	2 (0.75)				
Thermistors	E52-THE5A E52-THE6F E52-THE6D 	-50°C to 300°C	Thermistor	Element-interchangeable thermistor	1	SUS304	Exposed lead wires	29	

- Note:**
1. General-purpose models and low-cost models are provided on the previous page.
 2. These tables provide general specifications only. Be sure to read the detailed specifications and precautions before use.
 3. The temperature range varies with the material, thickness, and construction of the protective tubing.

■ Accessories

It is recommended that the following accessories be used for mounting Temperature Sensors.

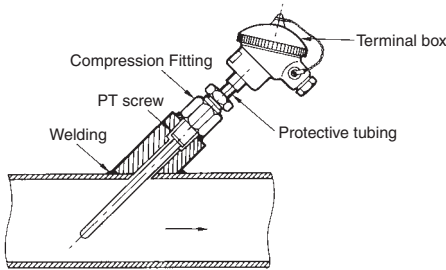
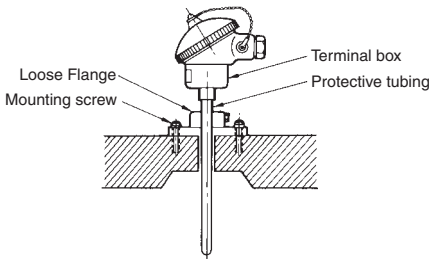
Accessory	Temperature range	Mounting example	Page
Compression Fitting	600°C max.	<p>Mounting with Compression Fitting</p>  <p>Note: The Compression Fitting is not of airtight construction. Do not use the Compression Fitting for applications in which the exposure of the sensing object will cause problems.</p>	30
Loose Flange	400°C max.	<p>Mounting with Loose Flange</p>  <p>Note:</p> <ol style="list-style-type: none"> 1. Use the Loose Flange in normal atmospheric pressure. The Loose Flange is not of airtight construction. 2. Use the Loose Flange at 400°C max. 3. Do not apply the Loose Flange to protective tubing diameters other than the applicable ones. 	

■ Lead Wires

Accessory		Specification	Temperature range	Page
For resistance thermometers	Standard	Vinyl-covered with twelve 0.18-dia. conductors (0.3 mm thick) and 4.8 mm in outer dia.	-20°C to 70°C	---
	Heat resistive	Glass-wool-covered with twenty 0.18-dia. conductors (0.5 mm thick) externally shielded with stainless steel, 5.2 mm in outer dia.	0°C to 180°C Sleeve: 0°C to 100°C	
For thermocouples (compensating conductor)	Standard	Vinyl-covered with seven 0.3-dia. conductors (0.5 mm thick) and 3.2 x 5.0 mm in outer dia.	-20°C to 70°C	32
	Heat resistive	Glass-wool-covered with seven 0.3-dia. conductors (0.5 mm thick) externally shielded with stainless steel, 2.9 x 4.6 mm in outer dia.	0°C to 150°C Sleeve: 0°C to 100°C	

Model Number Structure

The type of resistance thermometer, protective tubing length, and lead length can be specified as shown below.

■ Model Number Legend

Platinum Resistance Thermometers

E52-□□□ D=□□□M
 1 2 3 4 5 6

1. Element type

P: Pt100

2. Protective tubing length (L)

Specify the length in centimeters within the following range:
 Unit (cm)

E52-□□A

Diameter (D)	Length (L)
3.2	7 to 100
4.8	10 to 600
6.4	13 to 1,300

E52-□□B

Diameter (D)	Length (L)
8	20 to 100

E52-□□C

Diameter (D)	Length (L)
3.2	12 to 100
4.8	15 to 600
6.4	18 to 1,300
8	21 to 100
10	26 to 100

3. Terminal

- A: Exposed lead wires
- B: Exposed terminals
- C: Enclosed terminals

Examples

Element: Pt100, protective tubing length: 420 mm, exposed leads, protective tubing dia.: 4.8 mm, heat resistive, lead length: 10 m
 E52-P42A D=4.8 NETU 10M

General-purpose Models

■ Sheathed Platinum Resistance Thermometers

Refer to *Model Number Legend* above for the Pt100.

Specifications

Element type	Pt100
Class	JIS class B
Sheath material	SUS316
Sheath outer diameter	3.2 dia., 4.8 dia., 6.4 dia.
Conductor type	3-conductor system
Temperature range	-200°C to 450°C (in dry air)

4. Diameter

- 3.2: 3.2-mm dia. (Protective tubing construction: Sheathed)
E52-□□A and E52-□□C only
- 4.8: 4.8-mm dia. (Protective tubing construction: Sheathed)
E52-□□A and E52-□□C only
- 6.4: 6.4-mm dia. (Protective tubing construction: Sheathed)
E52-□□A and E52-□□C only
- 8: 8-mm dia. (Protective tubing construction: Standard)
E52-□□B and E52-□□C only
- 10: 10-mm dia. (Protective tubing construction: Standard)
E52-□□C only

5. Heat resistance

Code	Temperature range	Lead type
---	-20°C to 70°C Sleeve: 0°C to 70°C	Vinyl-covered
NETU	0°C to 180°C Sleeve: 0°C to 100°C	Glass-wool-covered, externally shielded

Specify for E52-□□A model only.

6. Lead length (M)

Specify the length in meters within the following range for the E52-□□A only:
 Range: 1 to 100 m

Exposed-lead Models

E52-P□A

Dimensions

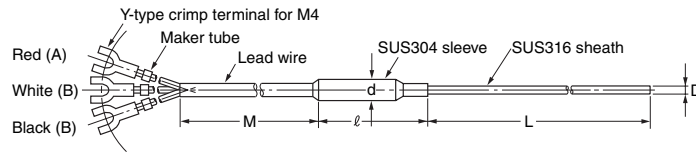

Unit (mm)

D	d	ℓ
3.2 dia.	8	60
4.8 dia.	8	60
6.4 dia.	8	60

Lead Wire

- Standard (−20°C to 70°C): Fully vinyl-covered with twelve 0.18-dia conductors (0.3 mm thick) and 4.8 mm in outer dia. The sleeve resists a temperature range between 0°C and 70°C.
- Heat Resistive (0°C to 180°C): Fully glass-wool-covered with twenty 0.18-dia. conductors (0.5 mm thick) externally shielded with stainless steel, 5.2 mm in outer dia. The sleeve resists a temperature range between 0°C and 100°C.
- Lead Wire Length (M): 1, 2, 4, or 8 m

Model Information

Custom-made models are available on request. Refer to page 4 for details.

Terminal type	Protective tubing diameter D (mm)	Protective tubing length L (cm)	Lead wire type	Lead wire length M (m)			
				1	2	4	8
				Model			
Exposed-lead Models	3.2 dia.	15	Standard	E52-P15A D=3.2 1M	E52-P15A D=3.2 2M	E52-P15A D=3.2 4M	E52-P15A D=3.2 8M
			Heat resistive	E52-P15A D=3.2 NETU 1M	E52-P15A D=3.2 NETU 2M	E52-P15A D=3.2 NETU 4M	E52-P15A D=3.2 NETU 8M
		20	Standard	E52-P20A D=3.2 1M	E52-P20A D=3.2 2M	E52-P20A D=3.2 4M	E52-P20A D=3.2 8M
			Heat resistive	E52-P20A D=3.2 NETU 1M	E52-P20A D=3.2 NETU 2M	E52-P20A D=3.2 NETU 4M	E52-P20A D=3.2 NETU 8M
		35	Standard	E52-P35A D=3.2 1M	E52-P35A D=3.2 2M	E52-P35A D=3.2 4M	E52-P35A D=3.2 8M
			Heat resistive	E52-P35A D=3.2 NETU 1M	E52-P35A D=3.2 NETU 2M	E52-P35A D=3.2 NETU 4M	E52-P35A D=3.2 NETU 8M
	4.8 dia.	20	Standard	E52-P20A D=4.8 1M	E52-P20A D=4.8 2M	E52-P20A D=4.8 4M	E52-P20A D=4.8 8M
			Heat resistive	E52-P20A D=4.8 NETU 1M	E52-P20A D=4.8 NETU 2M	E52-P20A D=4.8 NETU 4M	E52-P20A D=4.8 NETU 8M
		35	Standard	E52-P35A D=4.8 1M	E52-P35A D=4.8 2M	E52-P35A D=4.8 4M	E52-P35A D=4.8 8M
			Heat resistive	E52-P35A D=4.8 NETU 1M	E52-P35A D=4.8 NETU 2M	E52-P35A D=4.8 NETU 4M	E52-P35A D=4.8 NETU 8M
		50	Standard	E52-P50A D=4.8 1M	E52-P50A D=4.8 2M	E52-P50A D=4.8 4M	E52-P50A D=4.8 8M
			Heat resistive	E52-P50A D=4.8 NETU 1M	E52-P50A D=4.8 NETU 2M	E52-P50A D=4.8 NETU 4M	E52-P50A D=4.8 NETU 8M
	6.4 dia.	20	Standard	E52-P20A D=6.4 1M	E52-P20A D=6.4 2M	E52-P20A D=6.4 4M	E52-P20A D=6.4 8M
			Heat resistive	E52-P20A D=6.4 NETU 1M	E52-P20A D=6.4 NETU 2M	E52-P20A D=6.4 NETU 4M	E52-P20A D=6.4 NETU 8M
		35	Standard	E52-P35A D=6.4 1M	E52-P35A D=6.4 2M	E52-P35A D=6.4 4M	E52-P35A D=6.4 8M
			Heat resistive	E52-P35A D=6.4 NETU 1M	E52-P35A D=6.4 NETU 2M	E52-P35A D=6.4 NETU 4M	E52-P35A D=6.4 NETU 8M
		50	Standard	E52-P50A D=6.4 1M	E52-P50A D=6.4 2M	E52-P50A D=6.4 4M	E52-P50A D=6.4 8M
			Heat resistive	E52-P50A D=6.4 NETU 1M	E52-P50A D=6.4 NETU 2M	E52-P50A D=6.4 NETU 4M	E52-P50A D=6.4 NETU 8M

Enclosed-terminal Models

E52-P□C

Dimensions

Dimensions are given in millimeters, except for the length (L), which is provided in centimeters.

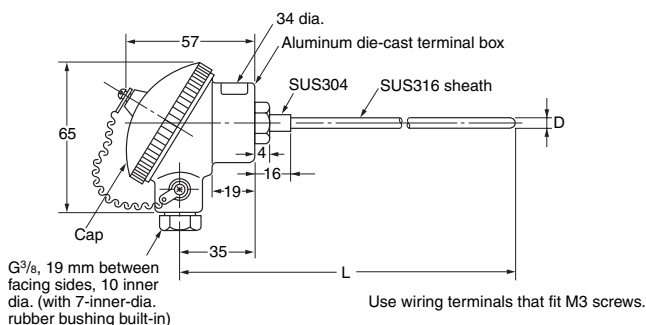

Terminal box: The permissible temperature is 0°C to 80°C.

Note: The terminals in the cap indicate polarity (A, B, b).

Model Information

Custom-made models are available on request. Refer to page 4 for details.

Terminal type	Protective tubing length L (cm)	Protective tubing diameter D (mm)		
		3.2 dia.	4.8 dia.	6.4 dia.
		Model		
Enclosed-terminal Models	20	E52-P20C D=3.2	E52-P20C D=4.8	E52-P20C D=6.4
	35	E52-P35C D=3.2	E52-P35C D=4.8	E52-P35C D=6.4
	50	E52-P50C D=3.2	E52-P50C D=4.8	E52-P50C D=6.4
	75	---	E52-P75C D=4.8	E52-P75C D=6.4

Standard Platinum Resistance Thermometers

Refer to *Model Number Legend* on page 4 for the Pt100.

Specifications

Element type	Pt100
Class	JIS class B (See note 2.)
Protective tubing material	SUS316
Conductor type	3-conductor system
Temperature range	0°C to 450°C (in dry air)

- Note:**
1. Use the sheathed platinum resistance thermometer if condensation is likely to result.
 2. Be sure that the thermometer is free of vibration or shock if high temperatures are measured.

Exposed-terminal Models

E52-P□B

Dimensions

Dimensions are given in millimeters, except for the length (L), which is provided in centimeters.

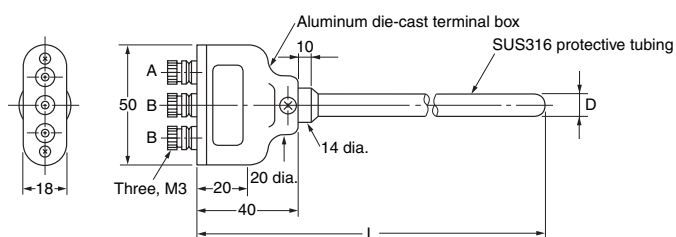

Terminal box:
The permissible temperature is 0°C to 100°C.

Model Information

Custom-made models are available on request. Refer to page 4 for details

Terminal type	Protective tubing length L (cm)	Protective tubing diameter D (mm)
		8 dia.
		Model
Exposed-terminal Models	20	E52-P20B D=8
	35	E52-P35B D=8
	50	E52-P50B D=8

Enclosed-terminal Models

E52-P□C

Dimensions

Dimensions are given in millimeters, except for the length (L), which is provided in centimeters.

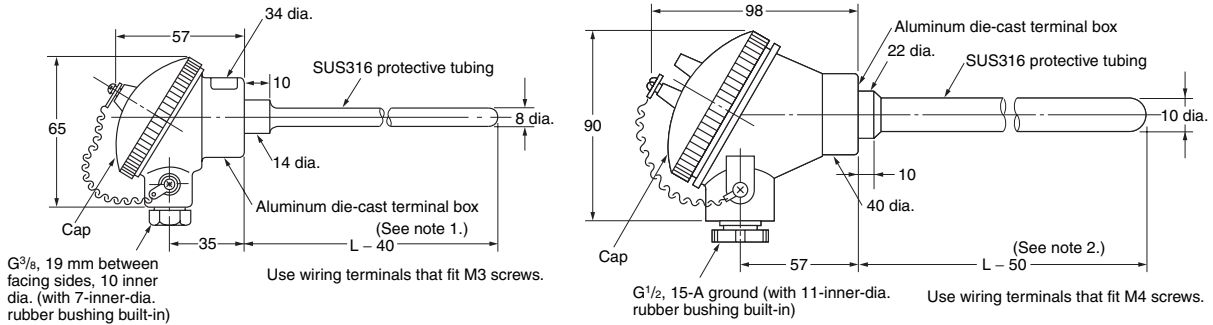

- Note:**
- The length L is in centimeters, but "40" is 40 millimeters. Therefore, for the E52-P20C, L = 20 (cm), the protective tubing length $L - 40 = 200 - 40 = 160$ mm.
 - The length L is in centimeters, but "50" is 50 millimeters. Therefore, for the E52-P75C: L = 75 (cm), the protective tubing length $L - 50 = 750 - 50 = 700$ mm.
 - Terminal box: The permissible temperature is 0°C to 80°C.

Model Information

Custom-made models are available on request. Refer to page 4 for details.

Terminal type	Protective tubing length L (cm)	Protective tubing diameter D (mm)	
		8 dia.	10 dia.
Model			
Enclosed-terminal Models	20	E52-P20C D=8	---
	35	E52-P35C D=8	E52-P35C D=10
	50	E52-P50C D=8	E52-P50C D=10
	75	---	E52-P75C D=10
	100	---	E52-P100C D=10

Note: The terminals in the cap indicate polarity (A, B, b).

■ Model Number Legend

The type of resistance thermometer, protective tubing length, and lead length can be specified as shown below.

Thermocouples

E52-□□□ D=□□□M□
 1 2 3 4 5 6 7

1. Element type

CA:K

IC: J

PR:R

2. Protective tubing length (L)

Specify the length in centimeters in the following range: Unit (cm)

E52-□□A (Exposed-lead Model)

Diameter (D)	Length (L)
1	2 to 200
1.6	3 to 500
3.2	5 to 2,000
4.8	8 to 2,300
6.4	10 to 1,200
8	12 to 1,000

E52-□□B and E52-□□C (except E52-PR□C)

Diameter (D)	Length (L)
3.2	11 to 2,000
4.8	14 to 2,300
6.4	16 to 1,200
8.0	18 to 1,000
10	21 to 126
12	24 to 126
15	29 to 156
22	39 to 206

E52-PR□C

Diameter (D)	Length (L)
17	50, 75, 100

3. Terminal

A: Exposed lead wires (element type: K, J)

B: Exposed terminals (element type: K, J)

C: Enclosed terminals (element type: K, J, R)

Examples

Element: K; protective tubing length: 420 mm, exposed leads, protective tubing dia.: 4.8 mm, heat resistive, lead length: 10 m
 E52-CA42A D=4.8 NETU 10M

Element: J; protective tubing length: 360 mm, enclosed terminals, protective tubing dia.: 3.2
 E52-IC36C D=3.2

4. Diameter

Specify the protective tubing material according to the table.

Code	Diameter (D)	Protective tubing construction	Protective tubing material
1	1 mm	Sheathed	SUS316
1.6	1.6 mm	Sheathed	SUS316
3.2	3.2 mm	Sheathed	SUS316
4.8	4.8 mm	Sheathed	SUS316
6.4	6.4 mm	Sheathed	SUS316
8	8 mm	Sheathed	SUS316
10	10 mm	Standard	SUS316, SUS310S
12	12 mm	Standard	SUS316, SUS310S
15	15 mm	Standard	SUS316, SUS310S
22	22 mm	Standard	SUS316, SUS310S
17	17 mm	Standard	PT1, PT0

5. Heat resistance

Specify this item for the exposed-lead models only.

Code	Temperature range	Lead type
---	-20°C to 70°C Sleeve: 0°C to 70°C	Vinyl-covered
NETU	0°C to 150°C Sleeve: 0°C to 100°C	Glass-wool-covered with external shield

6. Lead length (M)

Specify the length in meters in the following range for the E52-□□A only.

Range: 1 to 100 m

7. Protective tubing material

Code	Protective tubing material	Element type
---	SUS316	K, J
SUS310S	SUS310S	K, D = 10 to 22
PT1	JIS ceramic Cat.1	R
PT0	JIS special ceramic	R

Sheathed Thermocouples

Specifications

Element type	K (CA), J(IC)
Class	JIS class 2 (0.75)
Thermal contact	Non-grounded type
Sheath material	CA: SUS316
	IC: SUS316

Permissible Temperature in Dry Air

D	Element wire	
	K (CA) SUS316	J (IC) SUS316
1 dia.	650°C	450°C
1.6 dia.	650°C	450°C
3.2 dia.	750°C	650°C
4.8 dia.	800°C	750°C
6.4 dia.	800°C	750°C
8.0 dia.	900°C	750°C

Note: For details on the permissible temperature, refer to page D-5 of Introduction of Temperature Controllers (Cat. No. H900).

Exposed-lead Models

E52-CA□A

Dimensions

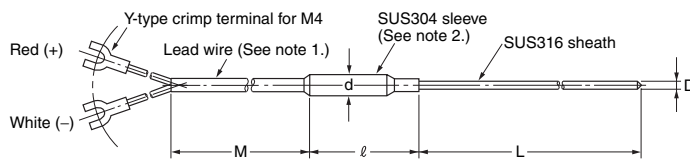

Note: 1. Lead Wire (Compensating Conductor)

- Standard (-20°C to 70°C): Fully vinyl-covered with seven 0.3-dia. conductors (0.5 mm thick) and external dimensions of 3.2 × 5.0.
 - Heat Resistive (0°C to 150°C): Fully glass-wool-covered with seven 0.3-dia. conductors (0.5 mm thick) with external shield of stainless steel and external dimensions of 2.9 × 4.6. The heat-resistive lead wires cannot be used in locations exposed to water or other liquids.
 - Lead Wire Length (M): 1, 2, 4, or 8 m
- 2.** The sleeve resists temperatures ranging between -20°C and 70°C for standard models and 0°C and 100°C for heat-resistive models.

Unit (mm)

D	d	l
1 dia.	7	40
1.6 dia.	7	40
3.2 dia.	7	40
4.8 dia.	7	40
6.4 dia.	10	45
8 dia.	10	45

Permissible Temperature in Dry Air

D	Element wire
	K (CA) SUS316
1 dia.	650°C
1.6 dia.	650°C
3.2 dia.	750°C
4.8 dia.	800°C
6.4 dia.	800°C
8.0 dia.	900°C

K (CA) Model Information (E52-CA□A)

Model Information

Custom-made models are available on request. Refer to *Model Number Legend* on page 8 for details.

Terminal type	Protective tubing diameter D (mm)	Protective tubing length L (cm)	Lead wire type	Lead wire length M (m)			
				1	2	4	8
				Model			
Exposed-lead Models	1 dia.	15	Standard	E52-CA15A D=1 1M	E52-CA15A D=1 2M	E52-CA15A D=1 4M	E52-CA15A D=1 8M
			Heat resistive	E52-CA15A D=1 NETU 1M	E52-CA15A D=1 NETU 2M	E52-CA15A D=1 NETU 4M	E52-CA15A D=1 NETU 8M
		20	Standard	E52-CA20A D=1 1M	E52-CA20A D=1 2M	E52-CA20A D=1 4M	E52-CA20A D=1 8M
			Heat resistive	E52-CA20A D=1 NETU 1M	E52-CA20A D=1 NETU 2M	E52-CA20A D=1 NETU 4M	E52-CA20A D=1 NETU 8M
		35	Standard	E52-CA35A D=1 1M	E52-CA35A D=1 2M	E52-CA35A D=1 4M	E52-CA35A D=1 8M
			Heat resistive	E52-CA35A D=1 NETU 1M	E52-CA35A D=1 NETU 2M	E52-CA35A D=1 NETU 4M	E52-CA35A D=1 NETU 8M
	1.6 dia.	15	Standard	E52-CA15A D=1.6 1M	E52-CA15A D=1.6 2M	E52-CA15A D=1.6 4M	E52-CA15A D=1.6 8M
			Heat resistive	E52-CA15A D=1.6 NETU 1M	E52-CA15A D=1.6 NETU 2M	E52-CA15A D=1.6 NETU 4M	E52-CA15A D=1.6 NETU 8M
		20	Standard	E52-CA20A D=1.6 1M	E52-CA20A D=1.6 2M	E52-CA20A D=1.6 4M	E52-CA20A D=1.6 8M
			Heat resistive	E52-CA20A D=1.6 NETU 1M	E52-CA20A D=1.6 NETU 2M	E52-CA20A D=1.6 NETU 4M	E52-CA20A D=1.6 NETU 8M
		35	Standard	E52-CA35A D=1.6 1M	E52-CA35A D=1.6 2M	E52-CA35A D=1.6 4M	E52-CA35A D=1.6 8M
			Heat resistive	E52-CA35A D=1.6 NETU 1M	E52-CA35A D=1.6 NETU 2M	E52-CA35A D=1.6 NETU 4M	E52-CA35A D=1.6 NETU 8M

Terminal type	Protective tubing diameter D (mm)	Protective tubing length L (cm)	Lead wire type	Lead wire length M (m)				
				1	2	4	8	
				Model				
Exposed-lead Models	3.2 dia.	15	Standard	E52-CA15A D=3.2 1M	E52-CA15A D=3.2 2M	E52-CA15A D=3.2 4M	E52-CA15A D=3.2 8M	
			Heat resistive	E52-CA15A D=3.2 NETU 1M	E52-CA15A D=3.2 NETU 2M	E52-CA15A D=3.2 NETU 4M	E52-CA15A D=3.2 NETU 8M	
		20	Standard	E52-CA20A D=3.2 1M	E52-CA20A D=3.2 2M	E52-CA20A D=3.2 4M	E52-CA20A D=3.2 8M	
			Heat resistive	E52-CA20A D=3.2 NETU 1M	E52-CA20A D=3.2 NETU 2M	E52-CA20A D=3.2 NETU 4M	E52-CA20A D=3.2 NETU 8M	
		35	Standard	E52-CA35A D=3.2 1M	E52-CA35A D=3.2 2M	E52-CA35A D=3.2 4M	E52-CA35A D=3.2 8M	
			Heat resistive	E52-CA35A D=3.2 NETU 1M	E52-CA35A D=3.2 NETU 2M	E52-CA35A D=3.2 NETU 4M	E52-CA35A D=3.2 NETU 8M	
		50	Standard	E52-CA50A D=3.2 1M	E52-CA50A D=3.2 2M	E52-CA50A D=3.2 4M	E52-CA50A D=3.2 8M	
			Heat resistive	E52-CA50A D=3.2 NETU 1M	E52-CA50A D=3.2 NETU 2M	E52-CA50A D=3.2 NETU 4M	E52-CA50A D=3.2 NETU 8M	
		4.8 dia.	20	Standard	E52-CA20A D=4.8 1M	E52-CA20A D=4.8 2M	E52-CA20A D=4.8 4M	E52-CA20A D=4.8 8M
				Heat resistive	E52-CA20A D=4.8 NETU 1M	E52-CA20A D=4.8 NETU 2M	E52-CA20A D=4.8 NETU 4M	E52-CA20A D=4.8 NETU 8M
			35	Standard	E52-CA35A D=4.8 1M	E52-CA35A D=4.8 2M	E52-CA35A D=4.8 4M	E52-CA35A D=4.8 8M
				Heat resistive	E52-CA35A D=4.8 NETU 1M	E52-CA35A D=4.8 NETU 2M	E52-CA35A D=4.8 NETU 4M	E52-CA35A D=4.8 NETU 8M
	50		Standard	E52-CA50A D=4.8 1M	E52-CA50A D=4.8 2M	E52-CA50A D=4.8 4M	E52-CA50A D=4.8 8M	
			Heat resistive	E52-CA50A D=4.8 NETU 1M	E52-CA50A D=4.8 NETU 2M	E52-CA50A D=4.8 NETU 4M	E52-CA50A D=4.8 NETU 8M	
	6.4 dia.	20	Standard	E52-CA20A D=6.4 1M	E52-CA20A D=6.4 2M	E52-CA20A D=6.4 4M	E52-CA20A D=6.4 8M	
			Heat resistive	E52-CA20A D=6.4 NETU 1M	E52-CA20A D=6.4 NETU 2M	E52-CA20A D=6.4 NETU 4M	E52-CA20A D=6.4 NETU 8M	
		35	Standard	E52-CA35A D=6.4 1M	E52-CA35A D=6.4 2M	E52-CA35A D=6.4 4M	E52-CA35A D=6.4 8M	
			Heat resistive	E52-CA35A D=6.4 NETU 1M	E52-CA35A D=6.4 NETU 2M	E52-CA35A D=6.4 NETU 4M	E52-CA35A D=6.4 NETU 8M	
		50	Standard	E52-CA50A D=6.4 1M	E52-CA50A D=6.4 2M	E52-CA50A D=6.4 4M	E52-CA50A D=6.4 8M	
			Heat resistive	E52-CA50A D=6.4 NETU 1M	E52-CA50A D=6.4 NETU 2M	E52-CA50A D=6.4 NETU 4M	E52-CA50A D=6.4 NETU 8M	
	8 dia.	20	Standard	E52-CA20A D=8 1M	E52-CA20A D=8 2M	E52-CA20A D=8 4M	E52-CA20A D=8 8M	
			Heat resistive	E52-CA20A D=8 NETU 1M	E52-CA20A D=8 NETU 2M	E52-CA20A D=8 NETU 4M	E52-CA20A D=8 NETU 8M	
		35	Standard	E52-CA35A D=8 1M	E52-CA35A D=8 2M	E52-CA35A D=8 4M	E52-CA35A D=8 8M	
			Heat resistive	E52-CA35A D=8 NETU 1M	E52-CA35A D=8 NETU 2M	E52-CA35A D=8 NETU 4M	E52-CA35A D=8 NETU 8M	
50		Standard	E52-CA50A D=8 1M	E52-CA50A D=8 2M	E52-CA50A D=8 4M	E52-CA50A D=8 8M		
		Heat resistive	E52-CA50A D=8 NETU 1M	E52-CA50A D=8 NETU 2M	E52-CA50A D=8 NETU 4M	E52-CA50A D=8 NETU 8M		

Exposed-lead Models

E52-IC□A

Dimensions

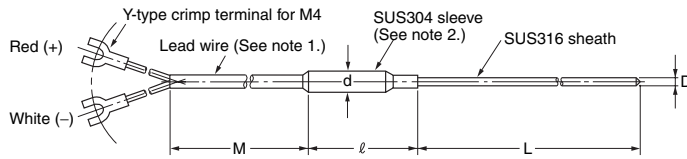

Note: 1. Lead Wire (Compensating Conductor)

- Standard (−20°C to 70°C): Fully vinyl-covered with seven 0.3-dia. conductors (0.5 mm thick) and external dimensions of 3.2 × 5.0.
 - Heat Resistive (0°C to 150°C): Fully glass-wool-covered with seven 0.3-dia. conductors (0.5 mm thick) with external shield of stainless steel and external dimensions of 2.9 × 4.6. The heat-resistive lead wires cannot be used in locations exposed to water or other liquids.
 - Lead Wire Length (M): 1, 2, 4, or 8 m
2. The sleeve resists temperatures ranging between −20°C and 70°C for standard models and 0°C and 100°C for heat-resistive models.

Unit (mm)

D	d	ℓ
1 dia.	7	40
1.6 dia.	7	40
3.2 dia.	7	40
4.8 dia.	7	40
6.4 dia.	10	45
8 dia.	10	45

Permissible Temperature in Dry Air

D	Element wire
	J (IC) SUS316
1 dia.	450°C
1.6 dia.	450°C
3.2 dia.	650°C
4.8 dia.	750°C
6.4 dia.	750°C
8.0 dia.	750°C

J (IC) Model Information (E52-IC□A)

Model Information

Custom-made models are available on request. Refer to *Model Number Legend* on page 8 for details

Terminal type	Protective tubing diameter D (mm)	Protective tubing length L (cm)	Lead wire type	Lead wire length M (m)			
				1	2	4	8
				Model			
Exposed-lead Models	1 dia.	15	Standard	E52-IC15A D=1 1M	E52-IC15A D=1 2M	E52-IC15A D=1 4M	E52-IC15A D=1 8M
			Heat resistive	E52-IC15A D=1 NETU 1M	E52-IC15A D=1 NETU 2M	E52-IC15A D=1 NETU 4M	E52-IC15A D=1 NETU 8M
		20	Standard	E52-IC20A D=1 1M	E52-IC20A D=1 2M	E52-IC20A D=1 4M	E52-IC20A D=1 8M
			Heat resistive	E52-IC20A D=1 NETU 1M	E52-IC20A D=1 NETU 2M	E52-IC20A D=1 NETU 4M	E52-IC20A D=1 NETU 8M
		35	Standard	E52-IC35A D=1 1M	E52-IC35A D=1 2M	E52-IC35A D=1 4M	E52-IC35A D=1 8M
			Heat resistive	E52-IC35A D=1 NETU 1M	E52-IC35A D=1 NETU 2M	E52-IC35A D=1 NETU 4M	E52-IC35A D=1 NETU 8M
	1.6 dia.	15	Standard	E52-IC15A D=1.6 1M	E52-IC15A D=1.6 2M	E52-IC15A D=1.6 4M	E52-IC15A D=1.6 8M
			Heat resistive	E52-IC15A D=1.6 NETU 1M	E52-IC15A D=1.6 NETU 2M	E52-IC15A D=1.6 NETU 4M	E52-IC15A D=1.6 NETU 8M
		20	Standard	E52-IC20A D=1.6 1M	E52-IC20A D=1.6 2M	E52-IC20A D=1.6 4M	E52-IC20A D=1.6 8M
			Heat resistive	E52-IC20A D=1.6 NETU 1M	E52-IC20A D=1.6 NETU 2M	E52-IC20A D=1.6 NETU 4M	E52-IC20A D=1.6 NETU 8M
		35	Standard	E52-IC35A D=1.6 1M	E52-IC35A D=1.6 2M	E52-IC35A D=1.6 4M	E52-IC35A D=1.6 8M
			Heat resistive	E52-IC35A D=1.6 NETU 1M	E52-IC35A D=1.6 NETU 2M	E52-IC35A D=1.6 NETU 4M	E52-IC35A D=1.6 NETU 8M

Terminal type	Protective tubing diameter D (mm)	Protective tubing length L (cm)	Lead wire type	Lead wire length M (m)				
				1	2	4	8	
				Model				
Exposed-lead Models	3.2 dia.	15	Standard	E52-IC15A D=3.2 1M	E52-IC15A D=3.2 2M	E52-IC15A D=3.2 4M	E52-IC15A D=3.2 8M	
			Heat resistive	E52-IC15A D=3.2 NETU 1M	E52-IC15A D=3.2 NETU 2M	E52-IC15A D=3.2 NETU 4M	E52-IC15A D=3.2 NETU 8M	
		20	Standard	E52-IC20A D=3.2 1M	E52-IC20A D=3.2 2M	E52-IC20A D=3.2 4M	E52-IC20A D=3.2 8M	
			Heat resistive	E52-IC20A D=3.2 NETU 1M	E52-IC20A D=3.2 NETU 2M	E52-IC20A D=3.2 NETU 4M	E52-IC20A D=3.2 NETU 8M	
		35	Standard	E52-IC35A D=3.2 1M	E52-IC35A D=3.2 2M	E52-IC35A D=3.2 4M	E52-IC35A D=3.2 8M	
			Heat resistive	E52-IC35A D=3.2 NETU 1M	E52-IC35A D=3.2 NETU 2M	E52-IC35A D=3.2 NETU 4M	E52-IC35A D=3.2 NETU 8M	
		50	Standard	E52-IC50A D=3.2 1M	E52-IC50A D=3.2 2M	E52-IC50A D=3.2 4M	E52-IC50A D=3.2 8M	
			Heat resistive	E52-IC50A D=3.2 NETU 1M	E52-IC50A D=3.2 NETU 2M	E52-IC50A D=3.2 NETU 4M	E52-IC50A D=3.2 NETU 8M	
		4.8 dia.	20	Standard	E52-IC20A D=4.8 1M	E52-IC20A D=4.8 2M	E52-IC20A D=4.8 4M	E52-IC20A D=4.8 8M
				Heat resistive	E52-IC20A D=4.8 NETU 1M	E52-IC20A D=4.8 NETU 2M	E52-IC20A D=4.8 NETU 4M	E52-IC20A D=4.8 NETU 8M
			35	Standard	E52-IC35A D=4.8 1M	E52-IC35A D=4.8 2M	E52-IC35A D=4.8 4M	E52-IC35A D=4.8 8M
				Heat resistive	E52-IC35A D=4.8 NETU 1M	E52-IC35A D=4.8 NETU 2M	E52-IC35A D=4.8 NETU 4M	E52-IC35A D=4.8 NETU 8M
	50		Standard	E52-IC50A D=4.8 1M	E52-IC50A D=4.8 2M	E52-IC50A D=4.8 4M	E52-IC50A D=4.8 8M	
			Heat resistive	E52-IC50A D=4.8 NETU 1M	E52-IC50A D=4.8 NETU 2M	E52-IC50A D=4.8 NETU 4M	E52-IC50A D=4.8 NETU 8M	
	6.4 dia.	20	Standard	E52-IC20A D=6.4 1M	E52-IC20A D=6.4 2M	E52-IC20A D=6.4 4M	E52-IC20A D=6.4 8M	
			Heat resistive	E52-IC20A D=6.4 NETU 1M	E52-IC20A D=6.4 NETU 2M	E52-IC20A D=6.4 NETU 4M	E52-IC20A D=6.4 NETU 8M	
		35	Standard	E52-IC35A D=6.4 1M	E52-IC35A D=6.4 2M	E52-IC35A D=6.4 4M	E52-IC35A D=6.4 8M	
			Heat resistive	E52-IC35A D=6.4 NETU 1M	E52-IC35A D=6.4 NETU 2M	E52-IC35A D=6.4 NETU 4M	E52-IC35A D=6.4 NETU 8M	
		50	Standard	E52-IC50A D=6.4 1M	E52-IC50A D=6.4 2M	E52-IC50A D=6.4 4M	E52-IC50A D=6.4 8M	
			Heat resistive	E52-IC50A D=6.4 NETU 1M	E52-IC50A D=6.4 NETU 2M	E52-IC50A D=6.4 NETU 4M	E52-IC50A D=6.4 NETU 8M	
	8 dia.	20	Standard	E52-IC20A D=8 1M	E52-IC20A D=8 2M	E52-IC20A D=8 4M	E52-IC20A D=8 8M	
			Heat resistive	E52-IC20A D=8 NETU 1M	E52-IC20A D=8 NETU 2M	E52-IC20A D=8 NETU 4M	E52-IC20A D=8 NETU 8M	
		35	Standard	E52-IC35A D=8 1M	E52-IC35A D=8 2M	E52-IC35A D=8 4M	E52-IC35A D=8 8M	
			Heat resistive	E52-IC35A D=8 NETU 1M	E52-IC35A D=8 NETU 2M	E52-IC35A D=8 NETU 4M	E52-IC35A D=8 NETU 8M	
50		Standard	E52-IC50A D=8 1M	E52-IC50A D=8 2M	E52-IC50A D=8 4M	E52-IC50A D=8 8M		
		Heat resistive	E52-IC50A D=8 NETU 1M	E52-IC50A D=8 NETU 2M	E52-IC50A D=8 NETU 4M	E52-IC50A D=8 NETU 8M		

Exposed-terminal Models

E52-CA□B
E52-IC□B

Dimensions

Dimensions are given in millimeters, except for the length (L), which is provided in centimeters.

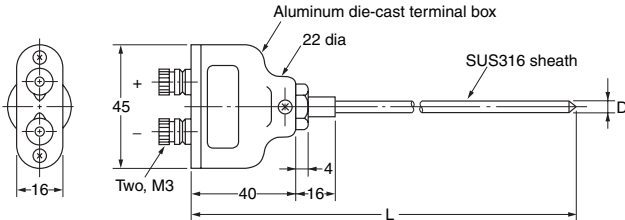

Permissible Temperature in Dry Air

D	Element wire	
	K (CA) SUS316	J (IC) SUS316
3.2 dia.	750°C	650°C
4.8 dia.	800°C	750°C
6.4 dia.	800°C	750°C
8.0 dia.	900°C	750°C

Terminal box: The permissible temperature is 0°C to 100°C.

Model Information

Custom-made models are available on request. Refer to *Model Number Legend* on page 8 for details.

Element type	Terminal type	Protective tubing length L (cm)	Protective tubing diameter D (mm)			
			3.2 dia.	4.8 dia.	6.4 dia.	8 dia.
Model						
K (CA)	Exposed-terminal Models	20	E52-CA20B D=3.2	E52-CA20B D=4.8	E52-CA20B D=6.4	---
		35	E52-CA35B D=3.2	E52-CA35B D=4.8	E52-CA35B D=6.4	E52-CA35B D=8
		50	E52-CA50B D=3.2	E52-CA50B D=4.8	E52-CA50B D=6.4	E52-CA50B D=8
		75	---	E52-CA75B D=4.8	E52-CA75B D=6.4	E52-CA75B D=8
J (IC)	Exposed-terminal Models	20	E52-IC20B D=3.2	E52-IC20B D=4.8	E52-IC20B D=6.4	---
		35	E52-IC35B D=3.2	E52-IC35B D=4.8	E52-IC35B D=6.4	E52-IC35B D=8
		50	E52-IC50B D=3.2	E52-IC50B D=4.8	E52-IC50B D=6.4	E52-IC50B D=8
		75	---	E52-IC75B D=4.8	E52-IC75B D=6.4	E52-IC75B D=8

Enclosed-terminal Models

E52-CA□C
E52-IC□C

Dimensions

Dimensions are given in millimeters, except for the length (L), which is provided in centimeters.

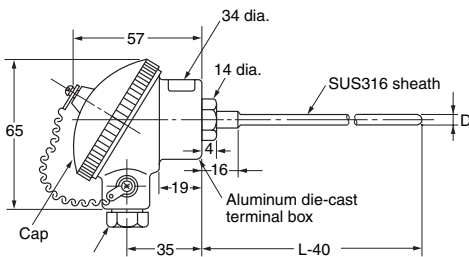

G^{3/8}, 19 mm between facing sides, 10 inner dia. (with 7-inner-dia. rubber bushing built-in)

Use wiring terminals that fit M3 screws.

Permissible Temperature in Dry Air

D	Element wire	
	K (CA) SUS316	J (IC) SUS316
3.2 dia.	750°C	650°C
4.8 dia.	800°C	750°C
6.4 dia.	800°C	750°C
8.0 dia.	900°C	750°C

Terminal box: The permissible temperature is 0°C to 80°C.

Note: The terminals in the cap indicate polarity (+ or -).

Model Information

Custom-made models are available on request. Refer to *Model Number Legend* on page 8 for details.

Element type	Terminal type	Protective tubing length L (cm)	Protective tubing diameter D (mm)			
			3.2 dia.	4.8 dia.	6.4 dia.	8 dia.
Model						
K (CA)	Enclosed-terminal Models	20	E52-CA20C D=3.2	E52-CA20C D=4.8	E52-CA20C D=6.4	---
		35	E52-CA35C D=3.2	E52-CA35C D=4.8	E52-CA35C D=6.4	E52-CA35C D=8
		50	E52-CA50C D=3.2	E52-CA50C D=4.8	E52-CA50C D=6.4	E52-CA50C D=8
		75	---	E52-CA75C D=4.8	E52-CA75C D=6.4	E52-CA75C D=8
J (IC)	Enclosed-terminal Models	20	E52-IC20C D=3.2	E52-IC20C D=4.8	E52-IC20C D=6.4	---
		35	E52-IC35C D=3.2	E52-IC35C D=4.8	E52-IC35C D=6.4	E52-IC35C D=8
		50	E52-IC50C D=3.2	E52-IC50C D=4.8	E52-IC50C D=6.4	E52-IC50C D=8
		75	---	E52-IC75C D=4.8	E52-IC75C D=6.4	E52-IC75C D=8

■ Standard Thermocouples

Specifications

Element wire	K (CA), J (IC), R	
Class	K (CA), J (IC) JIS class 2 (0.75)	
	R, JIS class 2 (0.25)	
Protective tubing material	K (CA)	SUS316
	J (IC)	SUS316
	R (See note.)	JIS ceramic cat. 1 (PT1)
		JIS special ceramic (PT0)
Thermal contact	Non-grounded type	

Note: Specify PT1 or PT0 if the element is R.

Permissible Temperature in Dry Air (See note.)

D	Element wire	
	K (CA) SUS316	J (IC) SUS316
10 dia.	750°C	450°C
12 dia.	850°C	500°C
15 dia.	850°C	550°C
22 dia.	900°C	600°C

Note: For details on the permissible temperature, refer to *Technical Guide for Temperature Sensors*.

D	Element wire
	R
17 dia.	0°C to 1,400°C

Exposed-terminal Models

E52-CA□B

E52-IC□B

Dimensions

Dimensions are given in millimeters, except for the length (L), which is provided in centimeters.

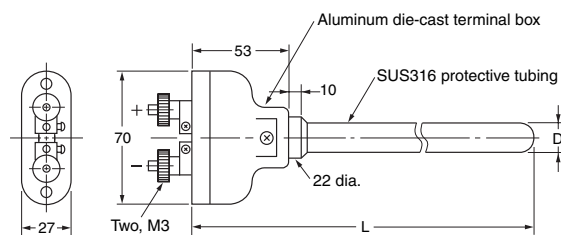

Terminal box: The permissible temperature is 0°C to 100°C.

Permissible Temperature in Dry Air

D	Element wire	
	K (CA) SUS316	J (IC) SUS316
10 dia.	750°C	450°C
12 dia.	850°C	500°C
15 dia.	850°C	550°C
22 dia.	900°C	600°C

Model Information

Custom-made models are available on request. Refer to *Model Number Legend* on page 8 for details.

Element type	Terminal type	Protective tubing length L (cm)	Protective tubing diameter D (mm)			
			10 dia.	12 dia.	15 dia.	22 dia.
Model						
K (CA)	Exposed-terminal Models	35	E52-CA35B D=10	E52-CA35B D=12	E52-CA35B D=15	---
		50	E52-CA50B D=10	E52-CA50B D=12	E52-CA50B D=15	E52-CA50B D=22
		75	E52-CA75B D=10	E52-CA75B D=12	E52-CA75B D=15	E52-CA75B D=22
		100	E52-CA100B D=10	E52-CA100B D=12	E52-CA100B D=15	E52-CA100B D=22
J (IC)	Exposed-terminal Models	35	E52-IC35B D=10	E52-IC35B D=12	E52-IC35B D=15	---
		50	E52-IC50B D=10	E52-IC50B D=12	E52-IC50B D=15	E52-IC50B D=22
		75	E52-IC75B D=10	E52-IC75B D=12	E52-IC75B D=15	E52-IC75B D=22
		100	E52-IC100B D=10	E52-IC100B D=12	E52-IC100B D=15	E52-IC100B D=22

Enclosed-terminal Models

E52-CA□C

E52-IC□C

Dimensions

Dimensions are given in millimeters, except for the length (L), which is provided in centimeters.

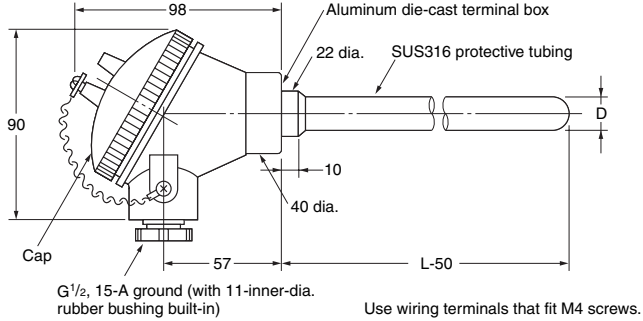

Permissible Temperature in Dry Air

D	Element wire	
	K (CA) SUS316	J (IC) SUS316
10 dia.	0 to 750°C	0 to 450°C
12 dia.	0 to 850°C	0 to 500°C
15 dia.	0 to 850°C	0 to 550°C
22 dia.	0 to 900°C	0 to 600°C

Terminal box: The permissible temperature is 0°C to 80°C.

Note: The terminals in the cap indicate polarity (+ or -).

Model Information

Custom-made models are available on request. Refer to *Model Number Legend* on page 8 for details

Element type	Terminal type	Protective tubing length L (cm)	Protective tubing diameter D (mm)			
			10 dia.	12 dia.	15 dia.	22 dia.
			Model			
K (CA)	Enclosed-terminal Models	35	E52-CA35C D=10	E52-CA35C D=12	E52-CA35C D=15	---
		50	E52-CA50C D=10	E52-CA50C D=12	E52-CA50C D=15	E52-CA50C D=22
		75	E52-CA75C D=10	E52-CA75C D=12	E52-CA75C D=15	E52-CA75C D=22
		100	E52-CA100C D=10	E52-CA100C D=12	E52-CA100C D=15	E52-CA100C D=22
J (IC)	Enclosed-terminal Models	35	E52-IC35C D=10	E52-IC35C D=12	E52-IC35C D=15	---
		50	E52-IC50C D=10	E52-IC50C D=12	E52-IC50C D=15	E52-IC50C D=22
		75	E52-IC75C D=10	E52-IC75C D=12	E52-IC75C D=15	---
		100	E52-IC100C D=10	E52-IC100C D=12	E52-IC100C D=15	E52-IC100C D=22

Enclosed-terminal Models (High-temperature Use)

E52-PR□C

Dimensions

Dimensions are given in millimeters, except for the length (L), which is provided in centimeters.

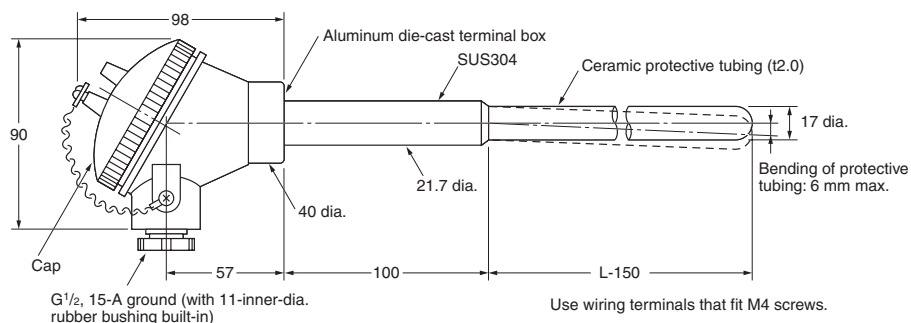

Permissible Temperature in Dry Air

D	Element wire
	R
17 dia.	0°C to 1,400°C

Terminal box: The permissible temperature is 0°C to 80°C.

Note: The terminals in the cap indicate polarity (+ or -).

Model Information

Element type	Terminal type	Protective tubing length L (cm)	Protective tubing diameter D (mm)
			17 dia.
			Model
R (See note 1.)	Enclosed-terminal Models	50	E52-PR50C D=17 PT1
		75	E52-PR75C D=17 PT1
		100	E52-PR100C D=17 PT1
R (See note 2.)	Enclosed-terminal Models	50	E52-PR50C D=17 PT0
		75	E52-PR75C D=17 PT0
		100	E52-PR100C D=17 PT0

Standard	Protective tubing material	Permissible temperature in dry air
Note 1: JIS ceramic Cat.1 (PT1)	Mullite, high alumina, etc.	1,500°C (See note.)
Note 2: JIS special ceramic (PT0)	Recrystallized alumina, fused alumina, etc.	1,700°C (See note.)

Note: The permissible temperature given for the protective tubing is higher than 1,400°C, but the permissible temperature of the thermocouple element wire is only 1,400°C. Therefore, the protective tubing of the E52-PR□C can withstand high temperatures momentarily to the levels given in the table as exceptions, but the element wire will deteriorate quickly if the thermocouple is used regularly at temperatures that exceed the permissible temperature for the element wire.

Low-cost Models

Low-cost Platinum Resistance Thermometers

Exposed-lead Models with Screws

Specifications

Element type	Pt100
Conductor type	3-conductor system
Class	Class B
Protective tubing material	SUS304
Sensor length	30 mm
Max. detectable temperature	250°C
Temperature range	-50°C to 250°C
Lead wire	-50°C to 150°C

E52-P6D

Dimensions

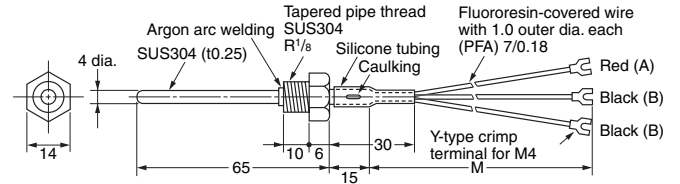

Note: The protective tubing is of pipe construction, which must not be bent.

Lead wire length (m)	Model
1	E52-P6D 1M
2	E52-P6D 2M
4	E52-P6D 4M

Exposed-lead Models with Flange

Specifications

Element wire	Pt100
Conductor type	3-conductor system
Class	Class B
Protective tubing material	SUS304
Sensor length	30 mm
Max. detectable temperature	250°C
Temperature range	-50°C to 250°C
Lead wire	-50°C to 150°C

E52-P6F

Dimensions

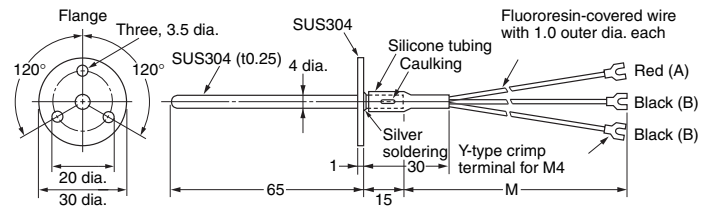

Note: The protective tubing is of pipe construction, which must not be bent.

Lead wire length (m)	Model
1	E52-P6F 1M
2	E52-P6F 2M
4	E52-P6F 4M

Exposed-lead Models

Specifications

Element type	Pt100
Conductor type	3-conductor system
Class	Class B
Protective tubing material	SUS304
Sensor length	20 mm
Max. detectable temperature	250°C
Temperature range	-50°C to 250°C
Lead wire	-50°C to 150°C

E52-P10AE

Dimensions

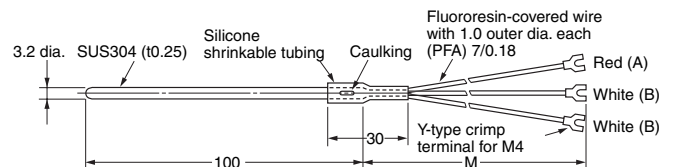

Note: 1. The protective tubing is of pipe construction, which must not be bent.

2. A Compression Fitting (PT□) cannot be used for mounting.

Lead wire length (m)	Model
1	E52-P10AE 1M
2	E52-P10AE 2M
4	E52-P10AE 4M

■ Low-cost Thermocouples

Exposed-lead Models with Spring

Specifications

Element type	K (CA), J (IC)
Element dia.	0.65 mm (single wire)
Class	Class 2 (0.75)
Protective tubing material	SUS304
Thermal contact	Non-grounded type
Temperature range	0°C to 400°C: K (CA) 0°C to 350°C: J (IC)
Lead wire	0°C to 180°C

E52-CA□AS, E52-IC□AS

Dimensions

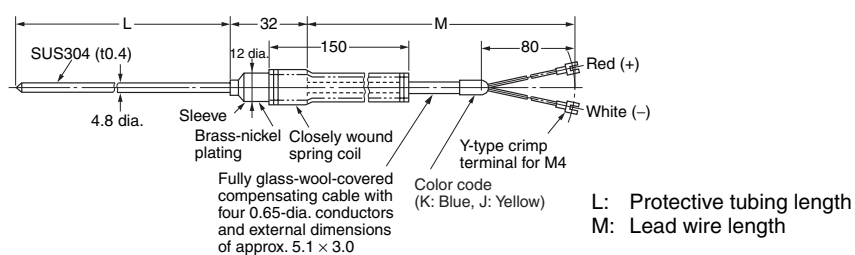

Note: The sleeve resists temperatures ranging between 0°C and 100°C.

Note: The protective tubing is of pipe construction, which must not be bent.

Protective tubing length (mm)	Lead wire length (m)	Element type: K (CA)	Element type: J (IC)
		Model	
65	1	E52-CA6AS 1M	E52-IC6AS 1M
	2	E52-CA6AS 2M	E52-IC6AS 2M
	4	E52-CA6AS 4M	E52-IC6AS 4M
100	1	E52-CA10AS 1M	E52-IC10AS 1M
	2	E52-CA10AS 2M	E52-IC10AS 2M
	4	E52-CA10AS 4M	E52-IC10AS 4M
150	1	E52-CA15AS 1M	E52-IC15AS 1M
	2	E52-CA15AS 2M	E52-IC15AS 2M
	4	E52-CA15AS 4M	E52-IC15AS 4M
200	1	E52-CA20AS 1M	E52-IC20AS 1M
	2	E52-CA20AS 2M	E52-IC20AS 2M
	4	E52-CA20AS 4M	E52-IC20AS 4M

Exposed-lead Models with Screw

Specifications

Element type	K (CA), J (IC)
Element dia.	0.65 mm (single wire)
Class	Class 2 (0.75)
Protective tubing material	SUS304
Thermal contact	Grounded type
Temperature range	0°C to 400°C: K (CA) 0°C to 350°C: J (IC)
Lead wire	0°C to 180°C

E52-CA1D, E52-IC1D

Dimensions

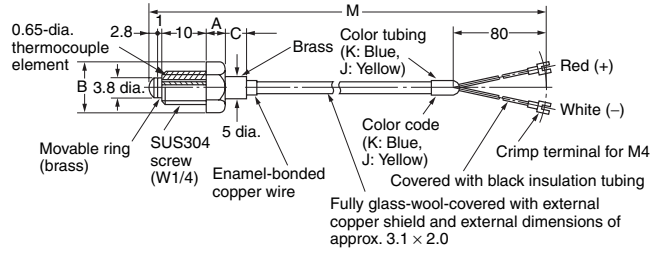

- Note:**
1. The thermocouple is a single wire from the tip to the terminal.
 2. Specify the type of screw (i.e., M6, M8, or W1/4) when ordering.
 3. The thermocouple is not of airtight construction.
 4. OMRON recommends that the tip of the thermocouple is touching the sensing object.

Internal Construction (E52-CA1D)

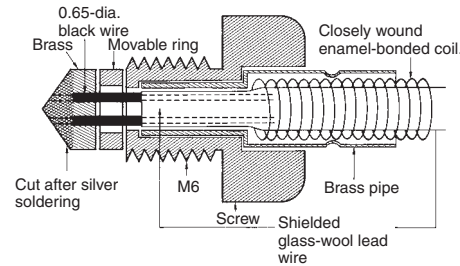

Lead wire length (m)	Screw		
	M1/4	M6	M8
A (mm)	5	4	5.3
B (mm)	11.5	11	14
C (mm)	3	4	2.5

Installation Example

Cut a thread into the workpiece, and screw in the thermocouple while pushing in so that the tip makes complete contact.

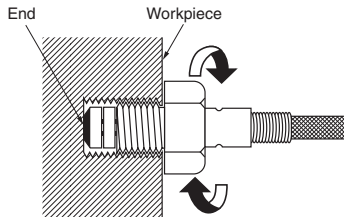

Note: E52-CA1D with the same shape and multiple element wires are also available (E52-CA1D-40). Refer to page 27 for details.

Protective tubing length (mm)	Lead wire length (m)	Element type: K (CA)	Element type: J (IC)
		Model	
M6 screw	1	E52-CA1D M6 1M	E52-IC1D M6 1M
	2	E52-CA1D M6 2M	E52-IC1D M6 2M
	4	E52-CA1D M6 4M	E52-IC1D M6 4M
M8 screw	1	E52-CA1D M8 1M	E52-IC1D M8 1M
	2	E52-CA1D M8 2M	E52-IC1D M8 2M
	4	E52-CA1D M8 4M	E52-IC1D M8 4M
W1/4 screw	1	E52-CA1D W1/4 1M	E52-IC1D W1/4 1M
	2	E52-CA1D W1/4 2M	E52-IC1D W1/4 2M
	4	E52-CA1D W1/4 4M	E52-IC1D W1/4 4M

Exposed-lead Models with Flange

Specifications

Element type	K (CA), J (IC)
Element diameter	0.65 mm (single wire)
Class	Class 2 (0.75)
Protective tubing material	SUS304
Thermal contact	Grounded type
Temperature range	0°C to 350°C: K (CA) 0°C to 350°C: J (IC)
Lead wire	0°C to 150°C

E52-CA6F, E52-IC6F

Dimensions

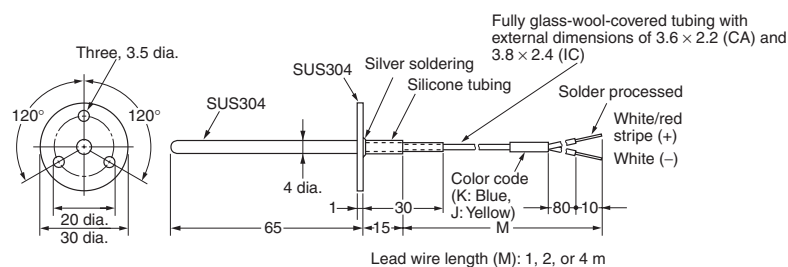

- Lead wire length (M): 1, 2, or 4 m
- Note:** 1. The thermocouple is a single wire from the tip to the terminal.
2. The tip is processed with solder, which ensures ease of welding.
3. The protective tubing is of pipe construction, which must not be bent.

Lead wire length (m)	Element type: K (CA)	Element type: J (IC)
	Model	
1	E52-CA6F 1M	E52-IC6F 1M
2	E52-CA6F 2M	E52-IC6F 2M
4	E52-CA6F 4M	E52-IC6F 4M

Exposed-lead Models with Screws

Specifications

Element type	K (CA), J (IC)
Element diameter	0.65 mm (single wire)
Class	Class 2 (0.75)
Protective tubing material	SUS304
Thermal contact	Grounded type
Temperature range	0°C to 350°C: K (CA) 0°C to 350°C: J (IC)
Lead wire	0°C to 150°C

E52-CA6D, E52-IC6D

Dimensions

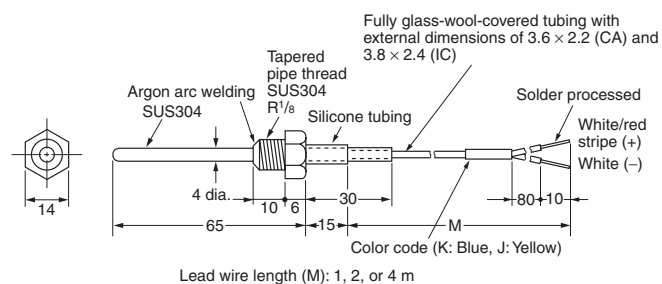

- Lead wire length (M): 1, 2, or 4 m
- Note:** 1. The thermocouple is a single wire from the tip to the terminal.
2. The tip is processed with solder, which ensures ease of welding.
3. The protective tubing is of pipe construction, which must not be bent.

Lead wire length (m)	Element type: K (CA)	Element type: J (IC)
	Model	
1	E52-CA6D 1M	E52-IC6D 1M
2	E52-CA6D 2M	E52-IC6D 2M
4	E52-CA6D 4M	E52-IC6D 4M

Exposed-lead Models Specifications

Element type	K (CA), J (IC)
Element diameter	0.32 mm (single wire)
Class	Class 2 (0.75)
Protective tubing material	SUS304
Thermal contact	Non-grounded type
Temperature range	0°C to 350°C: K (CA) 0°C to 200°C: J (IC)
Lead wire	0°C to 180°C

E52-CA10AE, E52-IC10AE

Dimensions

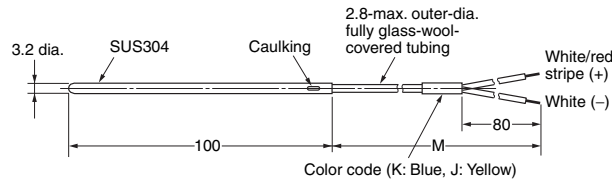

- Note:**
1. The thermocouple is a single wire from the tip to the terminal.
 2. Lead wire length M: 1, 2, or 4 m
 3. The protective tubing is of pipe construction, which must not be bent.
 4. The thermocouple cannot be mounted using a PT Compression Fitting.

Lead wire length (m)	Element type: K (CA)	Element type: J (IC)
	Model	
1	E52-CA10AE 1M	E52-IC10AE 1M
2	E52-CA10AE 2M	E52-IC10AE 2M
4	E52-CA10AE 4M	E52-IC10AE 4M

Exclusive Models

Thermocouples

Thermocouples for Molding Machines

Specifications

Element type	K (CA), J (IC)
Element diameter	1.0 mm (single wire)
Class	Class 2 (0.75)
Protective tubing material	SUS304
Thermal contact	Grounded type
Temperature range	0°C to 350°C
Lead wire	0°C to 180°C

E52-CA2GV, E52-IC2GV

Dimensions

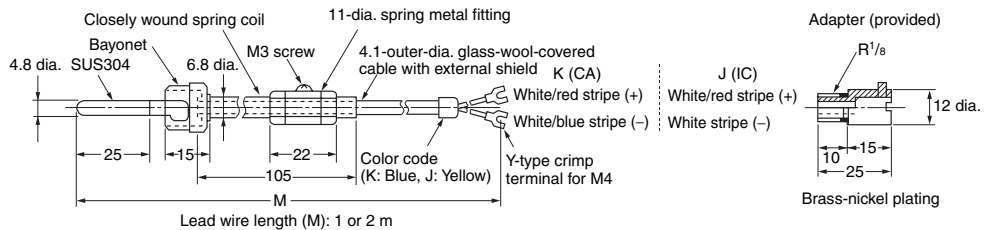

Lead wire length (m)	Element type: K (CA)	Element type: J (IC)
	Model	
1	E52-CA2GV 1M	E52-IC2GV 1M
2	E52-CA2GV 2M	E52-IC2GV 2M

Thermocouples with Crimp Terminals

Specifications

Element type	K (CA), J (IC)
Element diameter	0.65 mm (single wire)
Class	Class 2 (0.75)
Thermal contact	Grounded type
Temperature range	0°C to 300°C
Lead wire	0°C to 150°C

Note: The E52-CA1GT is also available with double elements. Refer to page 23 for details.

E52-CA1GT, E52-IC1GT

Dimensions

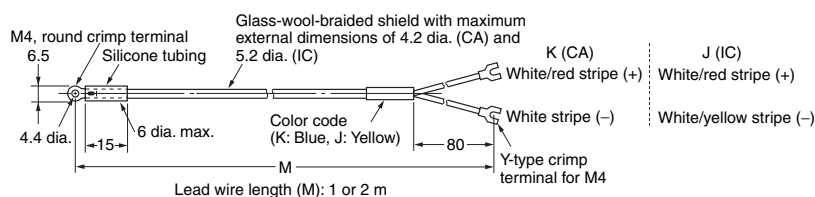

Lead wire length (m)	Element type: K (CA)	Element type: J (IC)
	Model	
1	E52-CA1GT 1M	E52-IC1GT 1M
2	E52-CA1GT 2M	E52-IC1GT 2M

Platinum Resistance Thermometers

Platinum Resistance Thermometers for Surface Temperature Measurement

Specifications

Element type	Pt100
Class	Class B
Protective tubing material	SUS304 With brass-nickel-plated bracket
Conductor type	3-conductor system
Temperature range	-50°C to 250°C
Lead wire	-50°C to 150°C

E52-P2GS

Dimensions

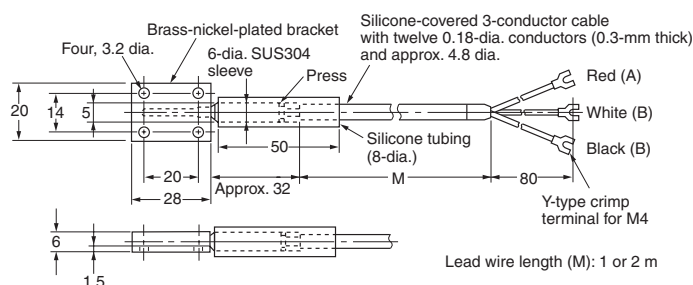

Lead wire length (m)	Model
1	E52-P2GS 1M
2	E52-P2GS 2M

Platinum Resistance Thermometers for Room Temperature Measurement

Specifications

Element type	Pt100
Class	Class B
Protective tubing material	SUS304
Conductor type	3-conductor system
Temperature range	-50°C to 60°C
Lead wire	-20°C to 70°C

E52-P10GR

Dimensions

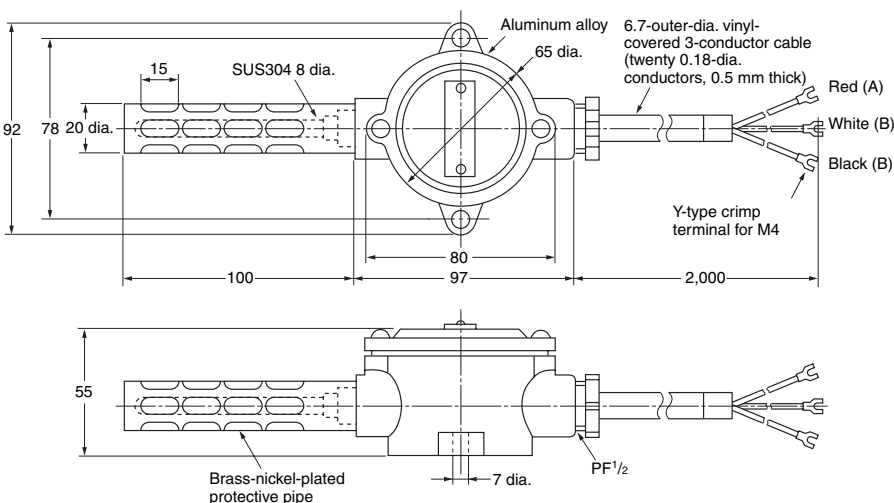

Lead wire length (m)	Model
2	E52-P10GR 2M

Double-element Platinum Resistance Thermometers

Specifications

Element type	Pt100
Class	Class B
Protective tubing material	SUS304
Conductor type	Double-element, 3-conductor system
Temperature range	-50°C to 250°C
Lead wire	-20°C to 70°C

E52-P20GW

Dimensions

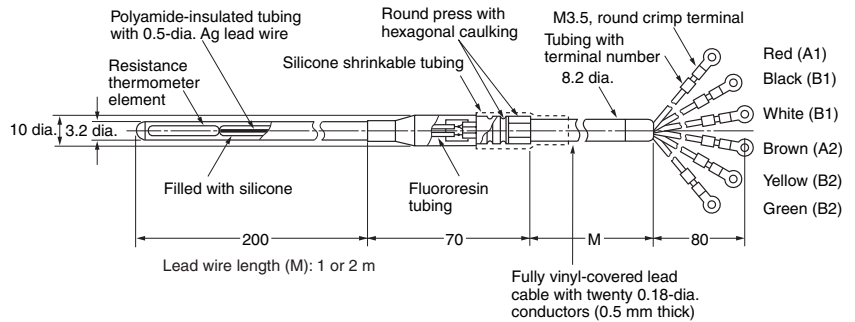

Note: The protective tubing is of pipe construction, which must not be bent.

Lead wire length (m)	Model
1	E52-P20GW 1M
2	E52-P20GW 2M

Waterproof Platinum Resistance Thermometers

Specifications

Element wire	Pt100
Class	Class B
Protective tubing material	SUS304
Conductor type	3-conductor system
Temperature range	0°C to 70°C (underwater) -20°C to 70°C (in the air)
Lead wire	0°C to 70°C

E52-P10GP

Dimensions

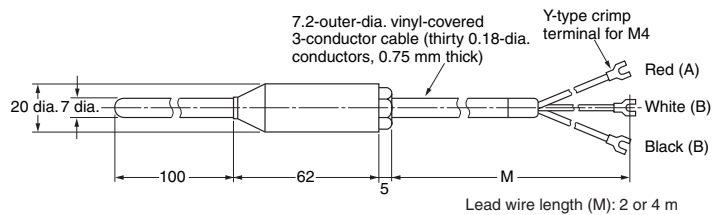

Note: The lead wires are vinyl-covered, and cannot be used underwater. Use the E52-P5A-40 if waterproof lead wires are required for use underwater. Refer to page 24 for details.

Lead wire length (m)	Model
2	E52-P10GP 2M
4	E52-P10GP 4M

Corrosion-resistant Models with Fluororesin-covered Protective Tubing

■ Thermocouples

Exposed-lead Models

Specifications

Element type	K (CA)
Class	Class 2 (0.75)
Protective tubing material	SUS316 with Fluororesin-covered (FEP) tube
Thermal contact	Non-grounded type
Temperature range	0°C to 180°C
Lead wire	Vinyl-covered: -20°C to 70°C

E52-CA20A-1

Dimensions

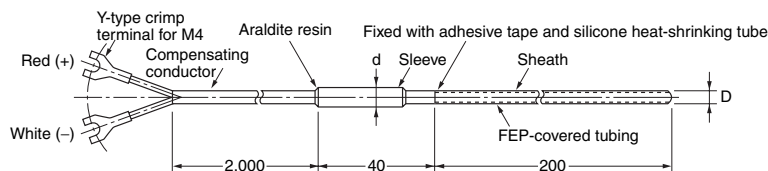

Model	Protective tubing diameter	Sleeve diameter (mm) Sleeve length (mm)	Covering thickness (mm)	Lead wire length (m)
E52-CA20A-1 D=4.6 2M	D = 4.6	d = 7 ℓ = 40	0.7	2
E52-CA20A-1 D=6 2M	D = 6.0	d = 10 ℓ = 45	0.6	
E52-CA20A-1 D=8 2M	D = 8.0		0.8	

■ Platinum Measurement

Exposed-lead Models

Specifications

Element type	Pt100
Class	Class B
Protective tubing material	SUS316 with Fluororesin-covered (FEP) tube
Conductor type	3-conductor system
Temperature range	-80°C to 180°C
Lead wire	Vinyl-covered: -20°C to 70°C

E52-P20A-1

Dimensions

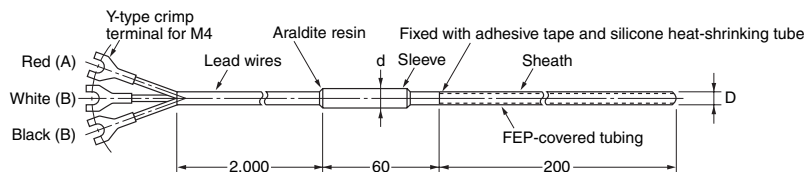

Model	Protective tubing diameter	Sleeve diameter (mm)	Coating thickness (mm)	Lead wire length (m)
E52-P20A-1 D=4.6 2M	D = 4.6	d = 8	0.7	2
E52-P20A-1 D=6 2M	D = 6.0	d = 8	0.6	
E52-P20A-1 D=8 2M	D = 8.0	d = 8	0.8	

FEP-molded Models (Completely Waterproof)

Specifications

Element type	Pt100
Class	Class B
Protective tubing material	Fluororesin-molded (FEP) covering
Conductor type	3-conductor system
Temperature range	-50°C to 180°C
Lead wire	Fluororesin-covered (PFA): -50°C to 180°C

E52-P5A-40

Dimensions

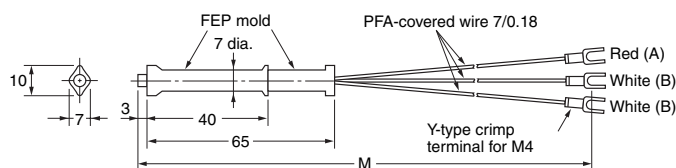

Model	Protective tubing diameter	Lead wire length (m)
E52-P5A-40 2M	D = 10 (elliptical)	2
E52-P5A-40 4M	D = 10 (elliptical)	4
E52-P5A-40 6M	D = 10 (elliptical)	6
E52-P5A-40 8M	D = 10 (elliptical)	8

Pressure-resistant Explosion-proof (d2G4) Models

■ Thermocouples

Enclosed-terminal Models

Specifications

Element type	K (CA)	
Class	Class 2 (0.75)	
Protective tubing material	L2 section: SUS316 L1 section: SUS304	
Operating temperature range (in dry air)	Sensor: -100°C to 900°C Terminal: 0°C to 70°C	
Explosion-proof specifications	Construction	Pressure-resistant explosion-proof structure
	Explosion-protected class and ignitability	d2G4
	Lead wire wiring method	Metal conduit connected with screws to terminal box
	Conduit thread	PF1/2
	Installation method	Conforms to Technical Recommendations of the Research Institute of Industrial Safety (Japan)

E52-CA□□C-6

Dimensions

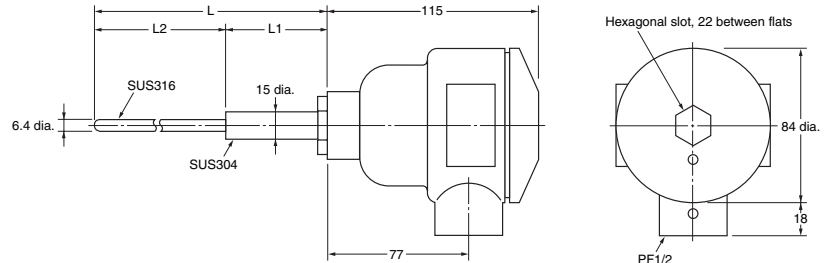

Model	Protective tubing length L (cm)	Protective tubing diameter	L2 (mm)
E52-CA20C-6 D=6.4 L2=150	20	D = 6.4	150
E52-CA35C-6 D=6.4 L2=300	35	D = 6.4	300
E52-CA50C-6 D=6.4 L2=450	50	D = 6.4	450
E52-CA75C-6 D=6.4 L2=700	75	D = 6.4	700

■ Platinum Resistance Thermometers for Surface Temperature Measurement

Enclosed-terminal Models

Specifications

Element type	Pt100	
Class	Class B	
Protective tubing material	L2 section: SUS316 L1 section: SUS304	
Operating temperature range (in dry air)	Sensor: -100°C to 500°C Terminal: 0°C to 70°C	
Explosion-proof specifications	Construction	Pressure-resistant explosion-proof structure
	Explosion-protected class and ignitability	d2G4
	Lead wire wiring method	Metal conduit connected with screws to terminal box
	Conduit thread	PF1/2
	Installation method	Conforms to Technical Recommendations of the Research Institute of Industrial Safety (Japan)

E52-P□□C-6

Dimensions

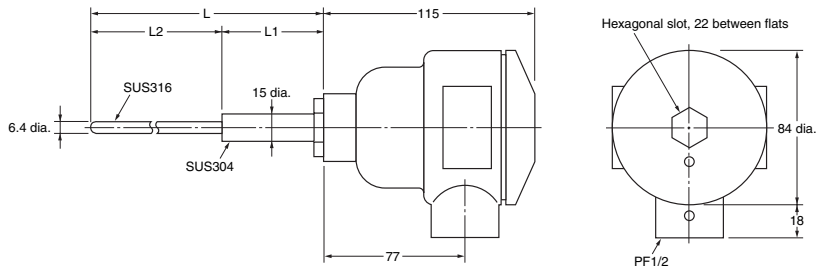

Model	Protective tubing length L (cm)	Protective tubing diameter	L2 (mm)
E52-P20C-6 D=6.4 L2=150	20	D = 6.4	150
E52-P35C-6 D=6.4 L2=300	35	D = 6.4	300
E52-P50C-6 D=6.4 L2=450	50	D = 6.4	450
E52-P75C-6 D=6.4 L2=700	75	D = 6.4	700

Double-element Models

■ Thermocouple

Exposed-lead Models

Specifications

Element type	K (CA)
Class	Class 2 (0.75)
Protective tubing material	SUS316 (with sheath)
Thermal contact	Non-grounded type
Temperature range	0°C to permissible temperature limit
Lead wire	Vinyl-covered: -20°C to 70°C

E52-CA20A-7

Dimensions

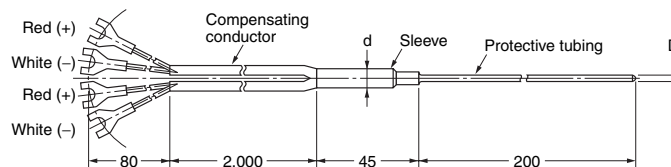

Permissible Temperature in Dry Air

D	Element wire
	K (CA) SUS316
3.2 dia.	750°C
4.8 dia.	800°C
6.4 dia.	850°C
8.0 dia.	900°C

Model	Protective tubing diameter	Sleeve diameter (mm)	Permissible Temperature (°C)	Lead wire length (m)
E52-CA20A-7 D=3.2 2M	D = 3.2	d = 10	750	2
E52-CA20A-7 D=4.8 2M	D = 4.8	d = 10	800	2
E52-CA20A-7 D=6.4 2M	D = 6.4	d = 10	800	2
E52-CA20A-7 D=8.0 2M	D = 8.0	d = 10	900	2

■ Platinum Resistance Thermometers

Exposed-lead Models

Specifications

Element type	Pt100
Class	Class B
Protective tubing material	SUS316 (with sheath)
Conductor type	3-conductor system
Temperature range	-200°C to 450°C
Lead wire	Vinyl-covered: -20°C to 70°C

E52-P20A-7

Dimensions

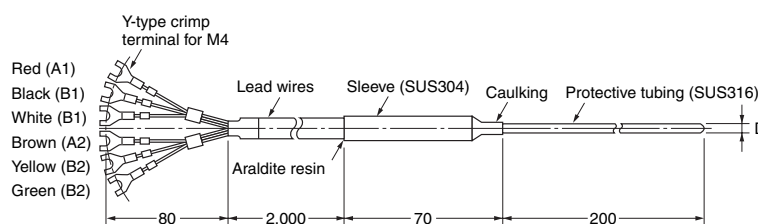

Model	Protective tubing diameter	Lead wire length (m)
E52-P20A-7 D=4.8 2M	D = 4.8	2
E52-P20A-7 D=6.4 2M	D = 6.4	2

Enclosed-terminal Models

Specifications

Element type	Pt100
Class	Class B
Protective tubing material	SUS316 (with sheath)
Conductor type	3-conductor system
Temperature range	-200°C to 450°C

E52-P20C-7

Dimensions

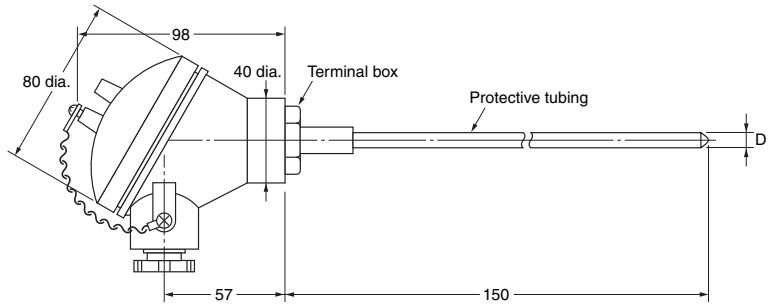

Model	Protective tubing length L (cm)	Protective tubing diameter
E52-P20C-7 D=4.8	20	D = 4.8
E52-P20C-7 D=6.4	20	D = 6.4

Silicone-covered Lead Wires Models

■ Thermocouples

Exposed-lead Models with Screws

Specifications

Element type	K (CA)
Class	Class 2 (0.75)
Screw material	SUS304
Thermal contact	Grounded type
Temperature range	0°C to 300°C
Lead wire	Silicone-covered (0.1/30): 0°C to 150°C

E52-CA1D-40

Dimensions

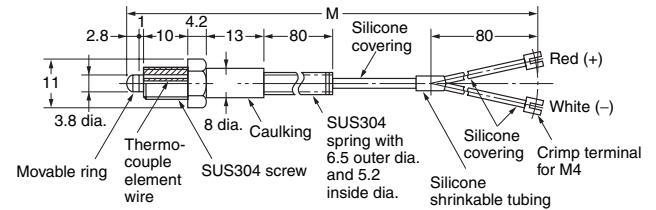

Model	Screw pitch	Lead wire length (m)
E52-CA1D-40 M6 1M	M6	1
E52-CA1D-40 M6 2M	M6	2
E52-CA1D-40 M6 4M	M6	4

Thermocouples with Crimp Terminals

Specifications

Element type	K (CA)
Class	Class 2 (0.75)
Thermal contact	Grounded type
Temperature range	0°C to 300°C
Lead wire	Silicone-covered (0.1/30): 0°C to 150°C

E52-CA1GT-14

Dimensions

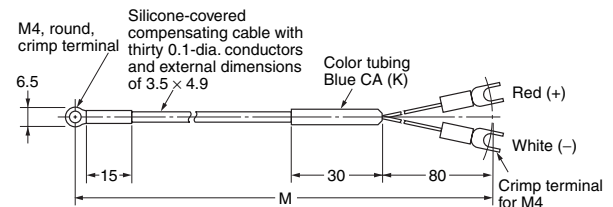

Lead wire length (M): 1 or 2 m

Model	Lead wire length (m)
E52-CA1GT-14 1M	1
E52-CA1GT-14 2M	2

Thermistors

Element Interchangeable Thermistor for E5CS and E5C2

Temperature Ranges

Temperature range	Color code	Nominal resistance	Thermistor constant	Lead wire
-50°C to 50°C	Blue	6 k Ω (0°C)	3390K	A pair of 0.12 dia. 7 Fluororesin-insulated stranded wires with 0.86 outer dia. each
0°C to 100°C	Black	6 k Ω (0°C)	3390K	
50°C to 150°C	Red	30 k Ω (0°C)	3450K	
100°C to 200°C	Yellow	0.55 k Ω (200°C)	4300K	
150°C to 300°C	Green	4 k Ω (200°C)	5133K	Flat glass-wool-shielded lead cable with 0.12 dia. 10 conductors and external dimensions of 2.5 × 1.55

Specifications

Item	E52-THE□□
Coupling method	Element interchangeable thermistor
Class	JIS class 1
Protective tubing material	SUS304
Time constant	8 to 15 s in still water
Dissipation factor	2.4 to 2.8 mW/°C in still air
Lead wire heat resistive temperature	180°C

Error

Detectable temperature	Error
-50°C to 100°C	±1°C max.
100°C to 350°C	±1% max. of detectable temperature

Permissible Temperature

Detectable temperature	Operating temperature
-50°C to 50°C	100°C
0°C to 100°C	150°C
50°C to 150°C	200°C
100°C to 200°C	250°C
150°C to 300°C	350°C

Note: Models with non-standard lead wire length and protective tubing length are available on request.

This Thermistor is a dedicated Thermistor for the E5C2 and E5CS.

Exposed-lead Models

E52-THE5A

Dimensions

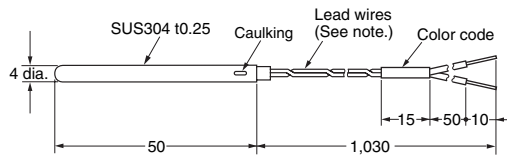

Note: The lead wires have no polarity

Temperature range	Model
-50°C to 50°C	E52-THE5A -50-50°C 1M
0°C to 100°C	E52-THE5A 0-100°C 1M
50°C to 150°C	E52-THE5A 50-150°C 1M
100°C to 200°C	E52-THE5A 100-200°C 1M
150°C to 300°C	E52-THE5A 150-300°C 1M

Exposed-lead Models with Screws

E52-THE6D

Dimensions

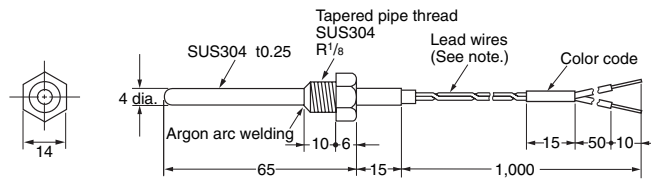

Note: The lead wires have no polarity

Temperature range	Model
-50°C to 50°C	E52-THE6D -50-50°C 1M
0°C to 100°C	E52-THE6D 0-100°C 1M
50°C to 150°C	E52-THE6D 50-150°C 1M
100°C to 200°C	E52-THE6D 100-200°C 1M
150°C to 300°C	E52-THE6D 150-300°C 1M

Exposed-lead Models with Flange

E52-THE6F

Dimensions

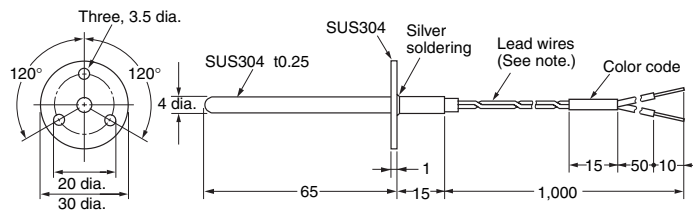

Note: The lead wires have no polarity

Temperature range	Model
-50°C to 50°C	E52-THE6F -50-50°C 1M
0°C to 100°C	E52-THE6F 0-100°C 1M
50°C to 150°C	E52-THE6F 50-150°C 1M
100°C to 200°C	E52-THE6F 100-200°C 1M
150°C to 300°C	E52-THE6F 150-300°C 1M

Note: 1. The Thermistor lead cable can be extended with a standard lead wire for extension. If waterproof performance is required, be sure that the lead cable joint is of waterproof construction as well.

2. Be sure to specify the model and temperature range when ordering the Thermistor. The Thermistor has a color code according to the temperature range.

Accessories

Compression Fittings

Model Information

Model	Screw of part a	Applicable protective tubing diameter	Dimension				
			b	c	d	Flat diameter	
						Part c	Part b
PT 1/8 D=1.0	R 1/8	1.0 dia.	5	13	10	14	14
PT 1/8 D=1.6		1.6 dia.					
PT 1/8 D=3.2		3.2 dia.					
PT 1/8 D=4.8		4.8 dia.					
PT 1/4 D=3.2	R 1/4	3.2 dia.	5	15	12	17	14
PT 1/4 D=4.8		4.8 dia.					
PT 1/4 D=6.4		6.4 dia.					
PT 3/8 D=8	R 3/8	8 dia.	5	19	15	21	17
PT 1/2 D=10	R 1/2	10 dia.	8	23.5	19.5	26	21
M 12 D=4.8	M 12	4.8 dia.	5	15	12	17	14

Note: The Compression Fitting is not of airtight construction. Do not use the Compression Fitting for applications in which the exposure of the sensing object will cause problems.

The compression fitting is a screw that adjusts and secures the insertion length of Temperature Sensors with the above protective tubing diameters.

The material of the Compression Fitting is SUS304 with internal fixing beads made of brass.

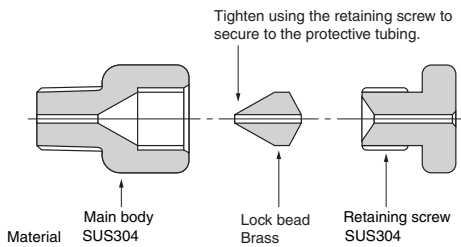
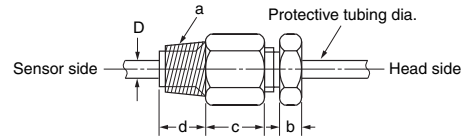

Source: JIS B 0203 (Unit: mm)

Nominal thread size	T.P.I. (No. of threads /inch)	Outer diameter: d	Effective diameter: d2	Root diameter: d1	Standard diameter position a (from pipe end)	Minimum effective screw length: f
PT 1/8	28	9.728	9.147	8.566	3.97 ±0.91	2.5
PT 1/4	19	13.157	12.301	11.445	6.01 ±1.34	3.7
PT 3/8	19	16.662	15.806	14.950	6.35 ±1.34	3.7
PT 1/2	14	20.955	19.793	18.631	8.16 ±1.81	5.0

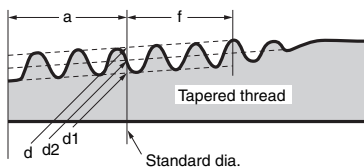

Loose Flanges

Model Information

Applicable protective tubing diameter	Model
3.2 dia.	MF-1 D=3.2
4.8 dia.	MF-1 D=4.8
6.4 dia.	MF-1 D=6.4
8 dia.	MF-1 D=8
10 dia.	MF-2 D=10
12 dia.	MF-2 D=12
15 dia.	MF-2 D=15
22 dia.	MF-2 D=22

- Note:**
1. Use the Loose Flange in atmospheric pressure. The Loose Flange is not of airtight construction.
 2. Use the Loose Flange at 400°C maximum.
 3. Do not apply the Loose Flange to protective tubing diameters other than the applicable ones.

Material: Aluminum

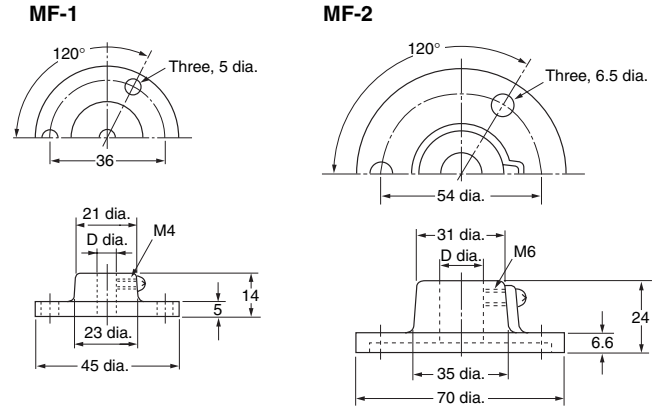

Compensating Conductors

The material of the Compensating Conductor is the same as or similar to that of the Thermocouple. Therefore, the Thermocouple can be connected to the Compensating Conductor just as if the length of the Thermocouple is to be extended. A standard model for a temperature range between -20°C and 70°C and two types of heat-resistive models for a temperature range between 0°C and 150°C are available.

Be sure to use the compensating conductor for the extension of the length of the thermocouple.

Model Information

Thermocouple	Heat resistance	Exterior (Length)	Model			
			1 m	2 m	4 m	8 m
R	Standard	Fully vinyl-covered (waterproof)	WPRG 1M	WPRG 2M	WPRG 4M	WPRG 8M
	Heat resistive	Fully glass-wool-covered	WPRH 1M	WPRH 2M	WPRH 4M	WPRH 8M
		Fully glass-wool-covered with external shield of stainless steel	WPRH6 1M	WPRH6 2M	WPRH6 4M	WPRH6 8M
K (CA)	Standard	Fully vinyl-covered (waterproof)	WCAG 1M	WCAG 2M	WCAG 4M	WCAG 8M
	Heat resistive	Fully glass-wool-covered	WCAH 1M	WCAH 2M	WCAH 4M	WCAH 8M
		Fully glass-wool-covered with external shield of stainless steel	WCAH6 1M	WCAH6 2M	WCAH6 4M	WCAH6 8M
		Silicone-covered (See note 2.)	WCAG-40 1M	WCAG-40 2M	WCAG-40 4M	WCAG-40 8M
J (IC)	Standard	Vinyl covered (waterproof)	WICG 1M	WICG 2M	WICG 4M	WICG 8M
	Heat resistive	Fully glass-wool-covered	WICH 1M	WICH 2M	WICH 4M	WICH 8M
		Fully glass-wool-covered with external shield of stainless steel	WICH6 1M	WICH6 2M	WICH6 4M	WICH6 8M

- Note:**
1. Compensating Conductors with lengths, increased in units of a meter, up to 100 meters are available on request. Specify lengths above 100 meters in units of 100 meters. The maximum length depends on the product. Contact your OMRON representative for details.
 2. It has the same waterproof characteristics as the standard model (fully vinyl-covered) and can be used at high temperatures.

Specifications (JIS C1610-1981)

Model	Type of thermocouple	Use	Code	Exterior	Number of wires/wire diameter	Operating temperature range ($^{\circ}\text{C}$)	Error ($^{\circ}\text{C}$)	Exterior color	Resistance of both lines (Ω/m)
WPRG	R	Standard	RX-G	Fully vinyl-covered (waterproof)	4/0.65	0 to 70	$\pm 3/-7$	Black	0.055
WPRH		Heat resistive	RX-H	Fully glass-wool-covered	7/0.3	0 to 150			0.140
WPRH6			RX-H6	Fully glass-wool-covered with external shield of stainless steel					
WCAG	K (CA)	Standard	VX-G	Fully vinyl-covered (waterproof)	4/0.65	-20 to 70	± 2.5	Blue	0.39
WCAH		Heat resistive	WX-H	Fully glass-wool-covered	7/0.3	0 to 150	± 3.0		1.07
WCAH6			WX-H6	Fully glass-wool-covered with external shield of stainless steel					
WCAG-40		Heat resistive for moving parts	KX-G	Silicone-covered	30/0.1	-20 to 150	± 2.5		4.18
WICG	J (IC)	Standard	JX-G	Fully vinyl-covered (waterproof)	4/0.65	-20 to 70	± 2.5	Yellow	0.47
WICH		Heat resistive	JX-H	Fully glass-wool-covered	7/0.3	0 to 150			1.27
WICH6			JX-H6	Fully glass-wool-covered with external shield of stainless steel					

ALL DIMENSIONS SHOWN ARE IN MILLIMETERS.

To convert millimeters into inches, multiply by 0.03937. To convert grams into ounces, multiply by 0.03527.

In the interest of product improvement, specifications are subject to change without notice.

Read and Understand This Catalog

Please read and understand this catalog before purchasing the products. Please consult your OMRON representative if you have any questions or comments.

Warranty and Limitations of Liability

WARRANTY

OMRON's exclusive warranty is that the products are free from defects in materials and workmanship for a period of one year (or other period if specified) from date of sale by OMRON.

OMRON MAKES NO WARRANTY OR REPRESENTATION, EXPRESS OR IMPLIED, REGARDING NON-INFRINGEMENT, MERCHANTABILITY, OR FITNESS FOR PARTICULAR PURPOSE OF THE PRODUCTS. ANY BUYER OR USER ACKNOWLEDGES THAT THE BUYER OR USER ALONE HAS DETERMINED THAT THE PRODUCTS WILL SUITABLY MEET THE REQUIREMENTS OF THEIR INTENDED USE. OMRON DISCLAIMS ALL OTHER WARRANTIES, EXPRESS OR IMPLIED.

LIMITATIONS OF LIABILITY

OMRON SHALL NOT BE RESPONSIBLE FOR SPECIAL, INDIRECT, OR CONSEQUENTIAL DAMAGES, LOSS OF PROFITS OR COMMERCIAL LOSS IN ANY WAY CONNECTED WITH THE PRODUCTS, WHETHER SUCH CLAIM IS BASED ON CONTRACT, WARRANTY, NEGLIGENCE, OR STRICT LIABILITY.

In no event shall the responsibility of OMRON for any act exceed the individual price of the product on which liability is asserted.

IN NO EVENT SHALL OMRON BE RESPONSIBLE FOR WARRANTY, REPAIR, OR OTHER CLAIMS REGARDING THE PRODUCTS UNLESS OMRON'S ANALYSIS CONFIRMS THAT THE PRODUCTS WERE PROPERLY HANDLED, STORED, INSTALLED, AND MAINTAINED AND NOT SUBJECT TO CONTAMINATION, ABUSE, MISUSE, OR INAPPROPRIATE MODIFICATION OR REPAIR.

Application Considerations

SUITABILITY FOR USE

OMRON shall not be responsible for conformity with any standards, codes, or regulations that apply to the combination of products in the customer's application or use of the products.

At the customer's request, OMRON will provide applicable third party certification documents identifying ratings and limitations of use that apply to the products. This information by itself is not sufficient for a complete determination of the suitability of the products in combination with the end product, machine, system, or other application or use.

The following are some examples of applications for which particular attention must be given. This is not intended to be an exhaustive list of all possible uses of the products, nor is it intended to imply that the uses listed may be suitable for the products:

- Outdoor use, uses involving potential chemical contamination or electrical interference, or conditions or uses not described in this catalog.
- Nuclear energy control systems, combustion systems, railroad systems, aviation systems, medical equipment, amusement machines, vehicles, safety equipment, and installations subject to separate industry or government regulations.
- Systems, machines, and equipment that could present a risk to life or property.

Please know and observe all prohibitions of use applicable to the products.

NEVER USE THE PRODUCTS FOR AN APPLICATION INVOLVING SERIOUS RISK TO LIFE OR PROPERTY WITHOUT ENSURING THAT THE SYSTEM AS A WHOLE HAS BEEN DESIGNED TO ADDRESS THE RISKS, AND THAT THE OMRON PRODUCTS ARE PROPERLY RATED AND INSTALLED FOR THE INTENDED USE WITHIN THE OVERALL EQUIPMENT OR SYSTEM.

PROGRAMMABLE PRODUCTS

OMRON shall not be responsible for the user's programming of a programmable product, or any consequence thereof.

Disclaimers

CHANGE IN SPECIFICATIONS

Product specifications and accessories may be changed at any time based on improvements and other reasons.

It is our practice to change model numbers when published ratings or features are changed, or when significant construction changes are made. However, some specifications of the products may be changed without any notice. When in doubt, special model numbers may be assigned to fix or establish key specifications for your application on your request. Please consult with your OMRON representative at any time to confirm actual specifications of purchased products.

DIMENSIONS AND WEIGHTS

Dimensions and weights are nominal and are not to be used for manufacturing purposes, even when tolerances are shown.

PERFORMANCE DATA

Performance data given in this catalog is provided as a guide for the user in determining suitability and does not constitute a warranty. It may represent the result of OMRON's test conditions, and the users must correlate it to actual application requirements. Actual performance is subject to the OMRON Warranty and Limitations of Liability.

ERRORS AND OMISSIONS

The information in this document has been carefully checked and is believed to be accurate; however, no responsibility is assumed for clerical, typographical, or proofreading errors, or omissions.

2011.5

In the interest of product improvement, specifications are subject to change without notice.

OMRON Corporation
Industrial Automation Company

<http://www.ia.omron.com/>

(c)Copyright OMRON Corporation 2011 All Right Reserved.

X-ON Electronics

Largest Supplier of Electrical and Electronic Components

Click to view similar products for [Industrial Temperature Sensors](#) category:

Click to view products by [Omron](#) manufacturer:

Other Similar products are found below :

[590-32AC34-103-WRI](#) [590-59CN02-103](#) [G9864ST22F0](#) [HEL-705-U-0-12-C1](#) [HEL-736-U-2-36](#) [HEL-717-U-0-24-00](#) [519-39AW09-245](#)
[519-39CH01-295](#) [535-32AB36-202](#) [535-34AE08-303](#) [512-32AQ01-503](#) [521-33AG04-303](#) [521-53BR01-503](#) [E52P6DY4M](#) [535-34AE09-222](#)
[590-32AC34-103](#) [590-32AD05-103](#) [HEL-705-U-0-36-00](#) [HEL-705-U-1-12-C2](#) [E52-CA6D-N 4M](#) [E52-P6DY 2M](#) [E52-P20C-N D=8](#) [E52-](#)
[THE5A 100-200 2M](#) [HRTS-5760-B-T-0-18](#) [6655-71990001](#) [LTPCTGA20MBSIBX01](#) [LTPCTAA20MDSIEX01](#) [BB-HS-104T2505402](#)
[NCP81255MNTXG](#) [HEL-707-T-1-24-00](#) [HEL-716-U-0-24-00](#) [USW2247](#) [R-11614-1](#) [RP103ST22P2](#) [R-10331-3F6](#) [E52-P20AY-D32 4M](#)
[B57045K0222K000](#) [B57045K0154K000](#) [PPG102A6](#) [R-7119](#) [R-8949-34](#) [BB-WTJ-10-36-TT](#) [20006233-00](#) [USW2889](#) [E52-P35C-ND3.2](#)
[NB-PTCO-142](#) [B57045K0682K000](#) [R-10224-16](#) [R-1630](#) [R-8204](#)