

“Mini-Cube” Pressure Sensor with Easy-to-Read LED Display

- Industry’s smallest, lightest model
- Both analog bar and digital pressure values are displayed
- Two independent outputs plus one analog output are available
- CE approved



Ordering Information

■ SENSORS

Pressure range	Digital output	Analog output	Part number
Positive pressure	0 to 100 kPa (0 to 14.5 psi)	1 to 5 V	E8F2-A01C
	0 to 1 MPa (0 to 145 psi)		E8F2-B10C
Negative pressure	0 to -101 kPa (0 to -14.6 psi)		E8F2-AN0C

■ ACCESSORIES (ORDER SEPARATELY)

Description	Part number
Panel-mounting Bracket	E89-F4

Application Examples

■ CHIP ATTACHMENT CHECKS

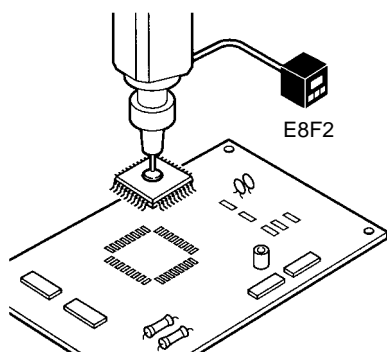

■ AIR PRESSURE CHECKS

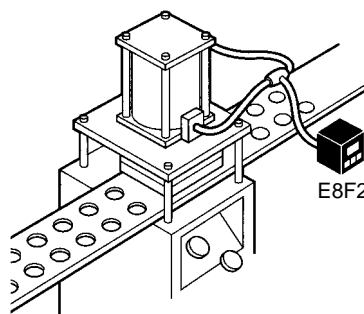

■ PCB AND WAFER ATTACHMENT CHECKS

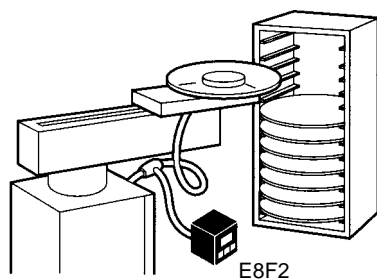

Specifications

■ RATINGS/CHARACTERISTICS

Item	E8F2-A01C	E8F2-B10C	E8F2-AN0C
Power supply voltage	12 to 24 VDC \pm 10% with a ripple (p-p) of 10% max.		
Current consumption	70 mA max. (See Note 1.)		
Pressure type	Gauge pressure		
Rated pressure range	0 to 100 kPa (0 to 14.5 psi)	0 to 1 MPa (0 to 145 psi)	0 to -101 kPa (0 to -14.6 psi)
Pressure setting range	0 to 100 kPa (0 to 14.5 psi)	0 to 1 MPa (0 to 145 psi)	0 to -101 kPa (0 to -14.6 psi)
Withstand pressure	400 kPa (58 psi)	1.5 MPa (217.6 psi)	400 kPa (58 psi)
Applicable fluid	Non-corrosive gas and non-flammable gas		
Operating mode	Hysteresis mode, window mode, and auto-teaching mode		
Repeat accuracy (ON/OFF output)	\pm 1% FS max.		
Linearity	\pm 1% FS max.		
Response time (ON/OFF output)	5 ms max.		

(This table continues on the next page.)

Specifications Table – continued from previous page

Item	E8F2-A01C	E8F2-B10C	E8F2-AN0C
Linear output	1 to 5 V \pm 5% FS with an output impedance of 1 k Ω and a permissible resistive load of 500 k Ω min.		
ON/OFF output	NPN open collector (NO/NC)		
	Load current	30 mA max.	
	Output applied voltage	30 VDC max.	
	Residual voltage	1 V max. with a load current of 30 mA	
Display (See Note 2.)	3.5-digit red LED Green LED bar indicator The orange LED is lit for two independent outputs with output transistor turned ON Green unit indicator		
Display accuracy	\pm 3% FS \pm 1 digit max.		
Circuit protection	Reverse polarity connection, load short-circuiting		
Ambient temperature	Operating	0°C to 55°C (32°F to 131°F)	
Ambient temperature	Storage	-10°C to 60°C (14°F to 140°F) with no icing	
Ambient humidity	Operating/ Storage	35% to 85% (with no condensation)	
Temperature influence	\pm 3% FS max.		
Voltage influence	\pm 1.5% FS max.		
Insulation resistance	100 M Ω min. (at 500 VDC) between current-carry parts and case		
Dielectric strength	1,000 VAC at 1 min		
Vibration resistance	Destruction: 10 to 500 Hz, 1.0-mm double amplitude or 150 m/s ² , 3 times each for 11 min in X, Y, and Z directions		
Shock resistance	300 m/s ² (30G) 3 times each in X, Y, and Z directions		
Degree of protection	IEC60529, IP50		
Pressure port	R(PT) 1/8 male screw and M5 female screw		
Connection method	Pre-wired (standard length: 2 m)		
Cable	Approved by UL		
Weight (incl. packing material)	Approx. 110 g (3.88 oz)		
Material	Pressure port	Aluminum die cast	
	Case	Heat-resistant ABS	
Accessories	Mounting bracket and instruction sheet		

- Note: 1. The current consumption is approximately 43 mA in energy-saving mode.
2. Display Example of Digital Indicator

Model	Setting unit					
	kPa		mmHg		kgf	
	Applied pressure	Digital display	Applied pressure	Digital display	Applied pressure	Digital display
E8F2-A01C	100	1 0 0 0	Cannot be set		1	1 0 0 0
E8F2-B10C	1,000	1 0 0 0			10	1 0 0 0
E8F2-AN0C	-101	- 1 0 1	-760	- 7 6 0	-1.01	- 1 0 1

Note: The “.” in the display indicates the decimal point. Its position will not change unless the setting unit is changed.

Engineering Data

TEMPERATURE VS. LINEAR OUTPUT CURRENT FLUCTUATION (TYPICAL)

E8F2-A01C

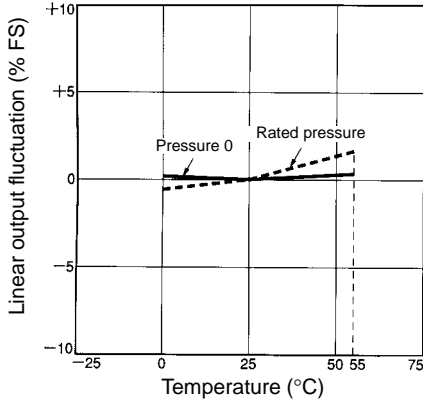

TEMPERATURE VS. OPERATING PRESSURE FLUCTUATION (TYPICAL)

E8F2-A01C

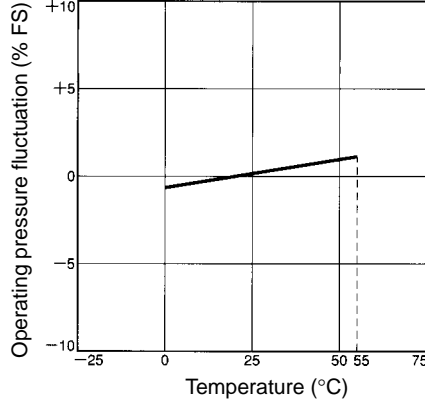

PRESSURE VS. LINEAR OUTPUT (TYPICAL)

E8F2-A01C

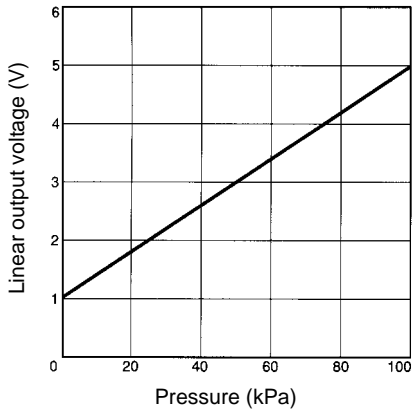

LINEARITY (TYPICAL)

E8F2-A01C

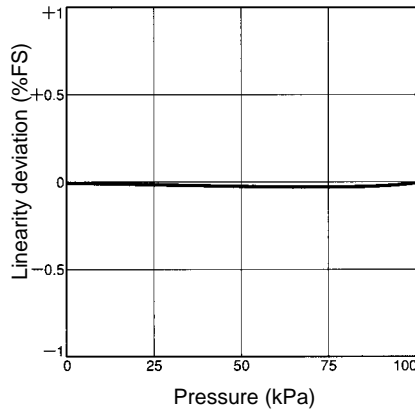

Nomenclature

■ E8F2 PRESSURE SENSOR

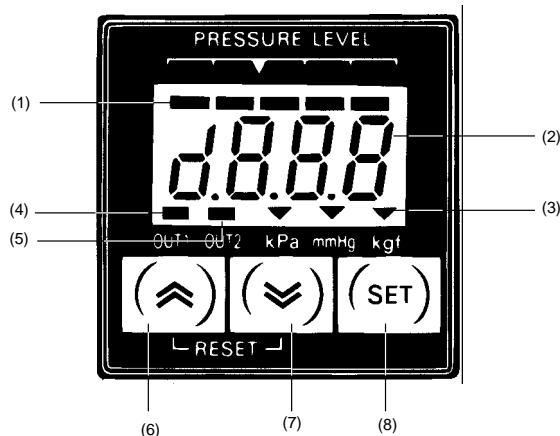

Display Panel

1. **Bar Indicator (Green)**
Indicates the degree of the measured pressure according to the the set pressure.
2. **Numeric and Menu Display (Red)**
Indicates measurement values and menu setting items.
3. **Unit Indicator (Green)**
Indicates the unit used for detection. The unit indicated with the indicator is the one currently set.
4. **OUT1 Indicator (Orange)**
Lit when OUT1 is turned ON.
5. **OUT2 Indicator (Orange)**
Lit when OUT2 is turned ON.

Operation Keys

6. **Up Key**
7. **Down Key**
 - Used to select or change the set items, set contents, and set values in setting mode.
 - Press either key to check the ON and OFF points in measurement mode. The values are reset by pressing both keys simultaneously.
 - Used together with the SET Key for setting the Sensor to a special setting mode or energy-saving mode.
8. **SET Key**
 - Used for entering the set contents and set values in setting mode.
 - Used for setting the Sensor to basic setting mode or pressure setting mode.

Operation

■ OUTPUT STAGE CIRCUIT

Output type		NPN output (normally open)	NPN output (normally closed)
Model		E8F2-A01C E8F2-B10C E8F2-AN0C	
Timing chart	Hysteresis mode		
	Window mode		
Output circuit			

FUNCTIONS AND SETTINGS

Function/Setting	Description	Page
Zero-reset function	Sets the measurement value to 0 when the Sensor is exposed to the air.	9
Basic setting mode	Unit setting	Changes the unit for detection.
	Pressure setting method	---
	Output-type setting	Selects normally-open or normally-closed output.
Pressure setting mode	Manual setting	Sets the ON and OFF points manually.
	Auto-teaching setting	Automatically sets the ON and OFF points depending upon the actual sensing of objects.
Special setting mode	Key-protect setting	Protects the set value against the incorrect operation of the keys. Prevents the set value against the careless operation of the keys.
	Hysteresis width setting	Changes the hysteresis range.
	Window range setting	Changes the window mode setting.
	Display refresh interval setting	Changes the display refresh interval to make the displayed value easier to see.
	Measurement value averaging time setting	Prevents incorrect output due to sudden, instantaneous changes that may occur with pressure.
Special setting mode	LED bar indicator range setting	Changes the display range of the LED bar indicator in hysteresis mode.
Energy-saving mode	Energy-saving function 1	Displays the LED bar indicator but turns the red LED display OFF.
	Energy-saving function 2	The LED bar indicator and red LED display flashes in window mode if the measured value exceeds the set range.
ON/OFF set value check function	Checks the set ON and OFF points.	18

SETTINGS

Digital Display

The E8F2 displays alphanumeric characters, such as the measurement values and menu items, with 7-segment LEDs. Refer to the examples shown below.

Display	Meaning
$\bar{d}PE$	In output operation
HPR	Unit (kPa)
$W\bar{L}d$	Width

The following abbreviations are used for the digital display of the Controller.

Abbreviation	Meaning	Abbreviation	Meaning
Unt	Unit	DSP	Display
M-A	Manual/Auto	AVE	Average
OPE	Operation	BAR	Bar
PRT	Protect	AUT	Auto
HYS	Hysteresis	ECO	Economy
WID	Width		

\bar{A}	\bar{B}	\bar{C}	\bar{D}	\bar{E}	\bar{F}	\bar{G}	\bar{H}	\bar{I}	\bar{J}	\bar{K}	\bar{L}	\bar{M}	\bar{N}	\bar{O}	\bar{P}	\bar{Q}	\bar{R}	\bar{S}	\bar{T}	\bar{U}	\bar{V}	\bar{W}	\bar{X}	\bar{Y}	\bar{Z}
A	B	C	D	E	F	G	H	I	J	K	L	M	N	O	P	Q	R	S	T	U	V	W	X	Y	Z

MODES

In addition to displaying measurement values, the E8F2 has a variety of functions. These functions are available in four main modes as described below: Measurement Mode, Basic Setting Mode, Pressure Setting Mode, Special Setting Mode. Three functions are available in measurement mode. For the relationships among each mode and for switching methods, refer to the following figure.

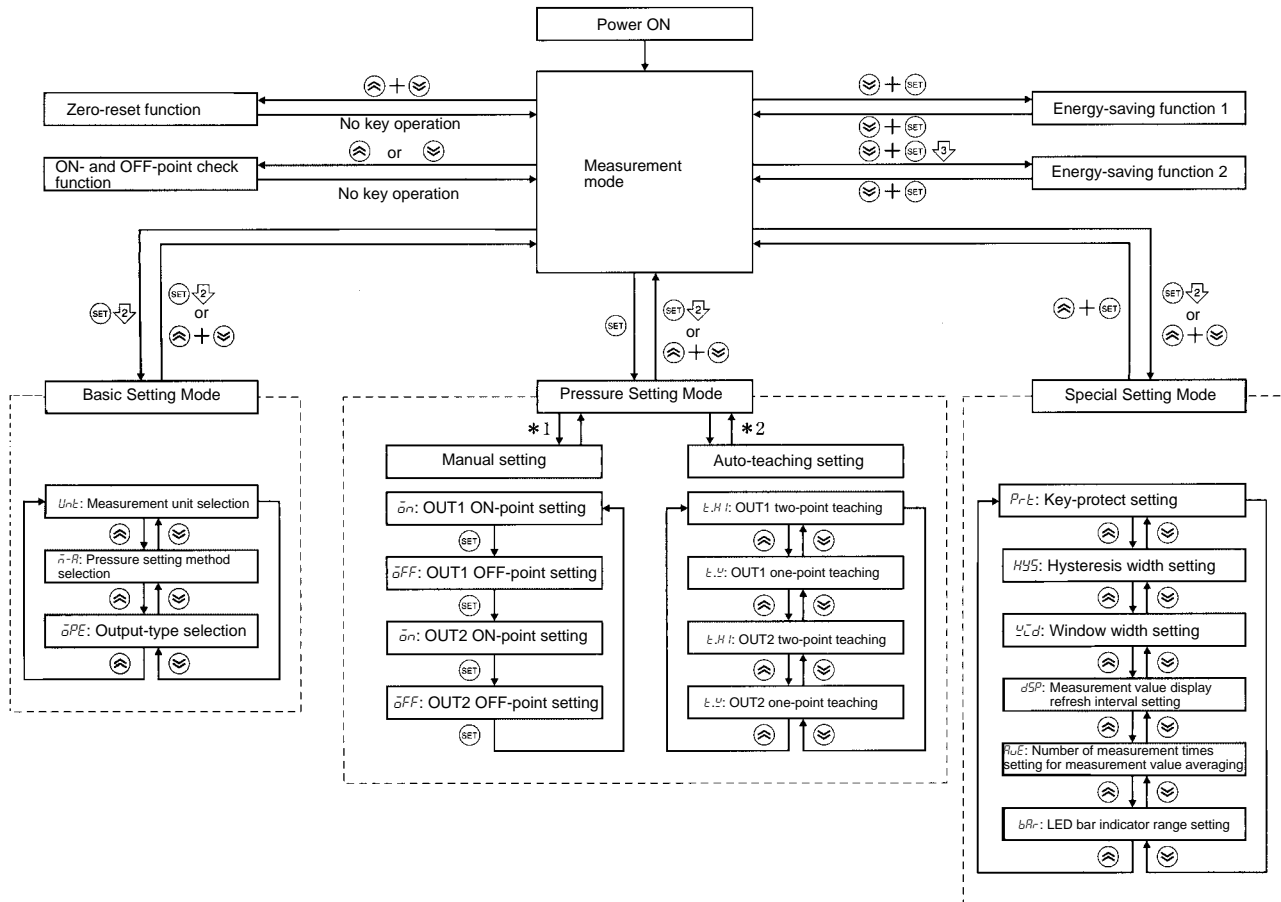

Note: 1. $\sqrt{2}$ and $\sqrt{3}$ indicate that the key must be pressed for approximately 2 or 3 s respectively.

2. The following will result when the E8F2 in basic, pressure setting, or special setting mode is reset to measurement mode.

$\text{SET} \sqrt{2}$: The set values are entered.

$\odot + \ominus$: The set values are not entered (left as they are).

*1. Manual setting is available by selecting \bar{n} (manual) in the pressure setting method selection in basic setting mode.

*2. Auto-teaching setting is available by selecting \bar{H} (auto-teaching) in the pressure setting method selection in basic setting mode.

Zero-reset Function

Use the zero-reset function with the Sensor exposed to the air.

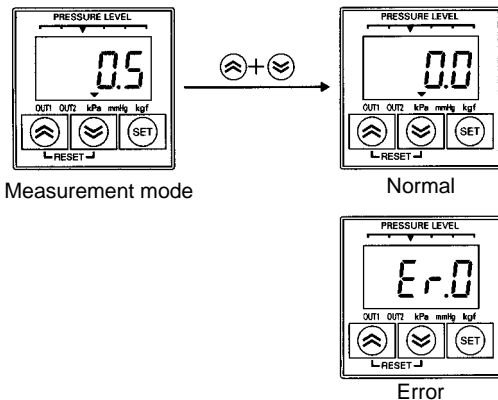

The displayed measurement value is reset to 0 by pressing the Up and Down Key simultaneously. The reset range is within $\pm 5\%$ (FS) of the rated pressure. If the value is not within the range, an error will be displayed and the reset will not be enabled.

Basic Setting Mode

The unit of measurement, pressure setting method, and output type are set in basic setting mode.

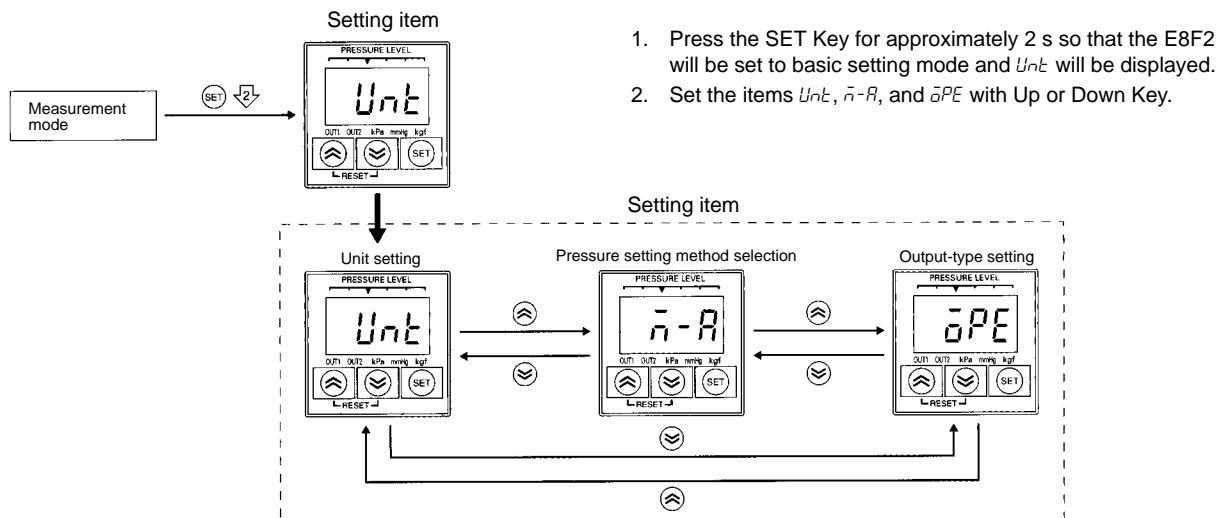

1. Press the SET Key for approximately 2 s so that the E8F2 will be set to basic setting mode and *Unt* will be displayed.
2. Set the items *Unt*, *n-R*, and *oPE* with Up or Down Key.

Unit Setting

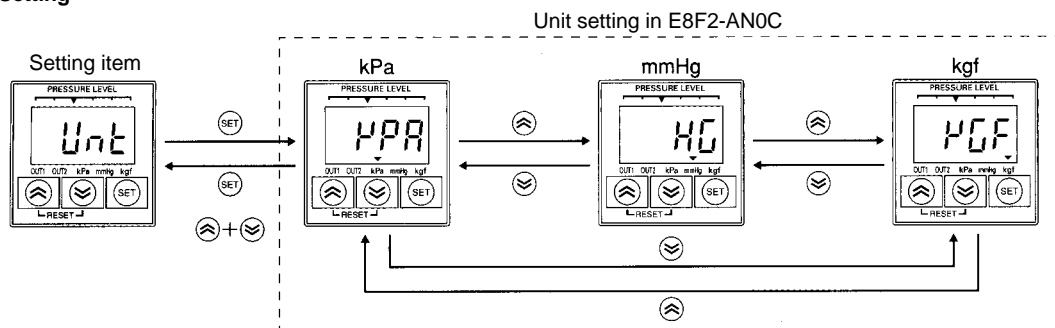

1. Press the SET Key while *Unt* is displayed to display the unit presently set.
2. Press the Up or Down Key to select the unit.
3. Press the SET Key to select the displayed unit and display *Unt* again.
4. Press the Up and Down Keys simultaneously, to display *unt* again without selecting the unit.

Pressure Setting Method Selection

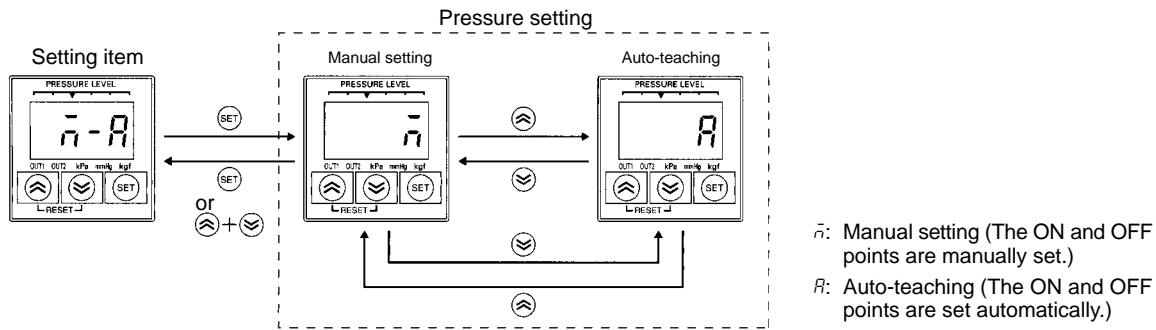

1. Press the SET Key while $\bar{n}-A$ is displayed to display the pressure setting method presently set.
2. Press the Up or Down Key to select the pressure setting method.
3. Press the SET Key to select the displayed pressure setting method and display $\bar{n}-A$ again.
4. Press the Up and Down Keys simultaneously to display $\bar{n}-A$ without selecting the unit.

Output-type Setting

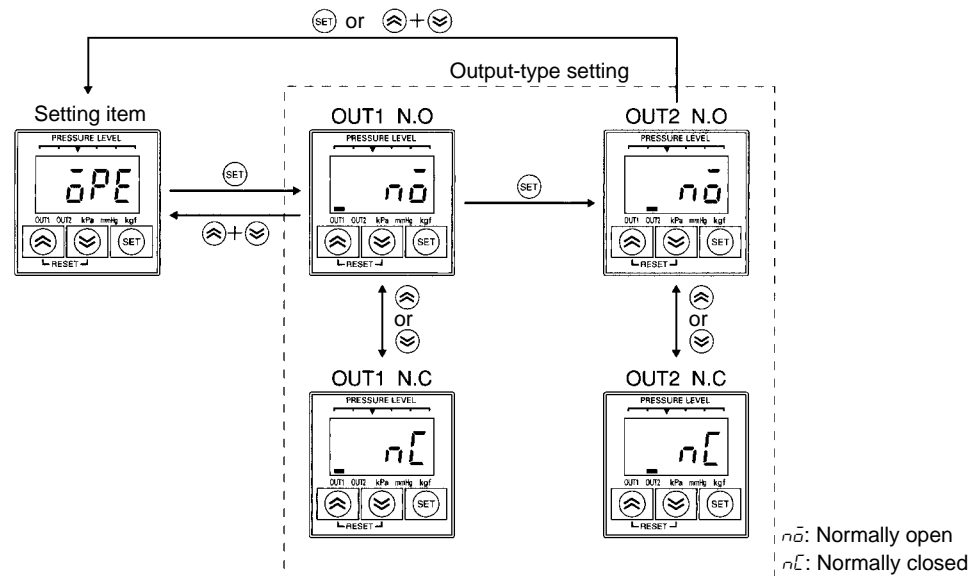

1. Press the SET Key while $\bar{o}PE$ is displayed to display the output type of OUT1 presently set.
2. Press the Up or Down Key to select the output type.
3. Press the SET Key to select the displayed output type and display the output type of OUT2 presently set.
4. Press the Up or Down Key to select the output type.
5. Press the SET Key to select the displayed output type and display $\bar{o}PE$ again.
6. Press the Up and Down Keys simultaneously to display $\bar{o}PE$ again without selecting the unit.

Returning to Measurement Mode

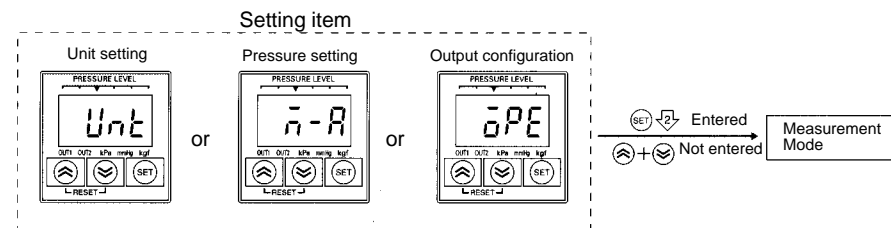

Entering the Setting Item:
Press the SET Key for approximately 2 s to enter the item that has been set.

Not Entering the Setting Item:
Press the Up and Down Keys simultaneously so that the item set will not be entered.

Pressure Setting Mode

The E8F2 provides output according to the measured values to control external devices, such as valves and pumps. In order to control the external devices, a reference value can be set so that the output will be ON or OFF if the measured values are above or below the reference value.

The output ON- and OFF-point settings are described below, provided that the output is normally open.

Note: The ON and OFF points are set in pressure setting mode manually or through auto-teaching.

Normally Open

Hysteresis Mode

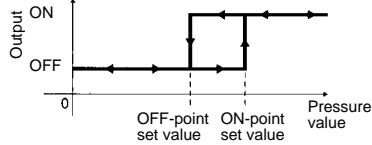

Window Mode

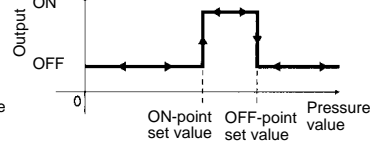

Normally Closed

Hysteresis Mode

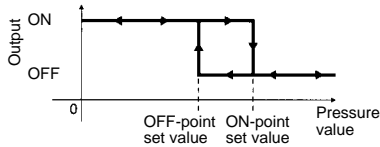

Window Mode

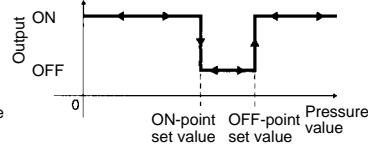

Manual Setting

Note: Manual setting will be possible if \bar{n} is selected in pressure setting method selection in basic setting mode.

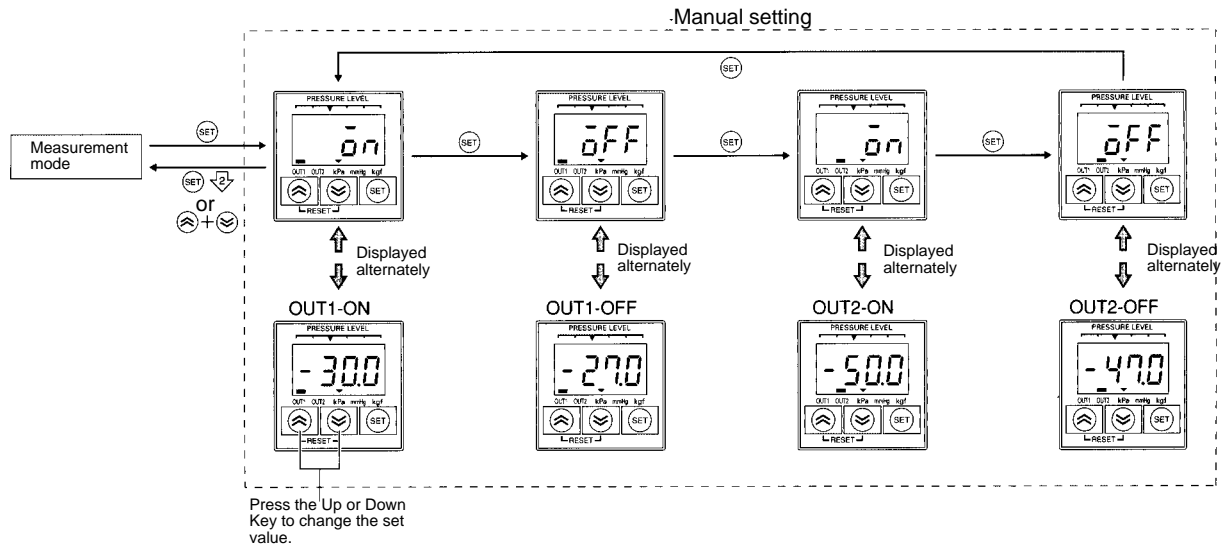

1. Press the SET Key, to set the E8F2 to pressure setting mode and display the OUT1 ON point and \bar{on} alternately.
2. Press the Up or Down Key to change the OUT1 ON point.
3. Press the SET Key to select the ON point and display the OUT1 OFF point and \bar{off} alternately.
4. Press the Up or Down Key to change the OUT1 OFF point.
5. Press the SET Key to select the displayed OFF point and display the OUT2 ON point and \bar{on} alternately.
6. Press the Up or Down Key to change the OUT2 ON point.
7. Press the SET Key to select the ON point and display the OUT2 OFF point and \bar{off} alternately.
8. Press the Up or Down Key to change the OUT2 OFF point.
9. Press the SET Key to select the OFF point and display the OUT1 ON point and \bar{on} alternately.

Returning to Measurement Mode

- Entering the Setting Item:
Press the SET Key for approximately 2 s to enter any item that has been set.
- Not Entering the Setting Item:
Press the Up and Down Keys simultaneously so that any item set will not be entered.

Auto-teaching

Auto-teaching allows input measured values to be input as ON- and OFF-point set values instead of key input. One- or two-point auto-teaching can be selected.

Note: Auto-teaching will be possible if *R* is selected in the pressure setting method selection in basic setting mode.

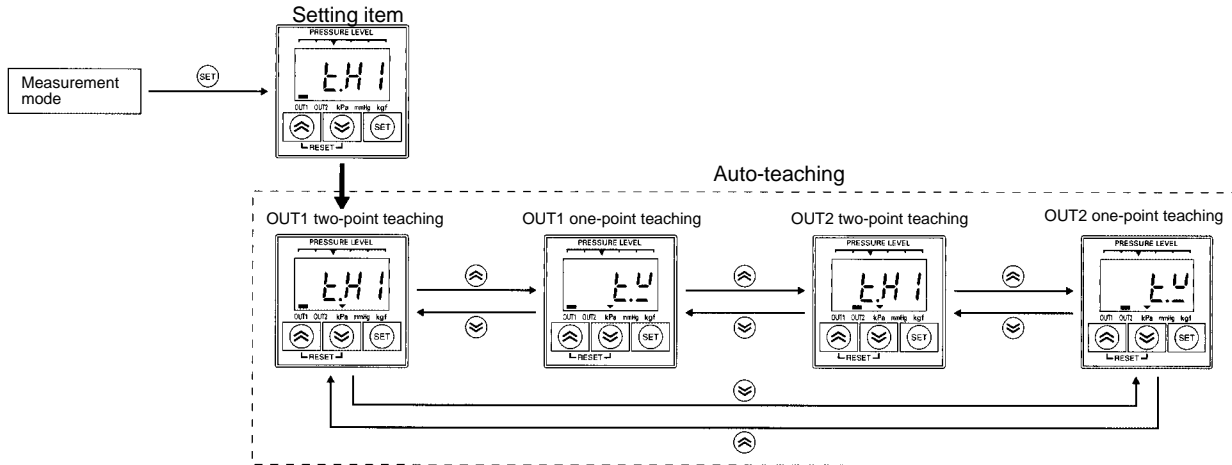
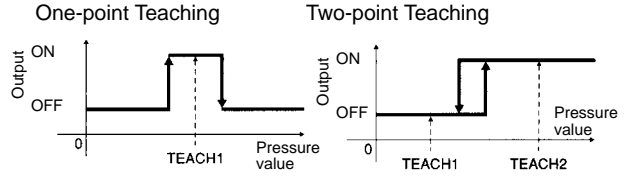

L.H1: Teach hysteresis mode at first point

L.U: Teach window mode

1. Press the SET Key to set the E8F2 to pressure setting mode and to display OUT1 and L.H1.
2. Press the Up or Down Key to select the one-point teaching or two-point teaching method of OUT1 and OUT2.

Two-point Teaching (Hysteresis-mode Teaching)

OUT1

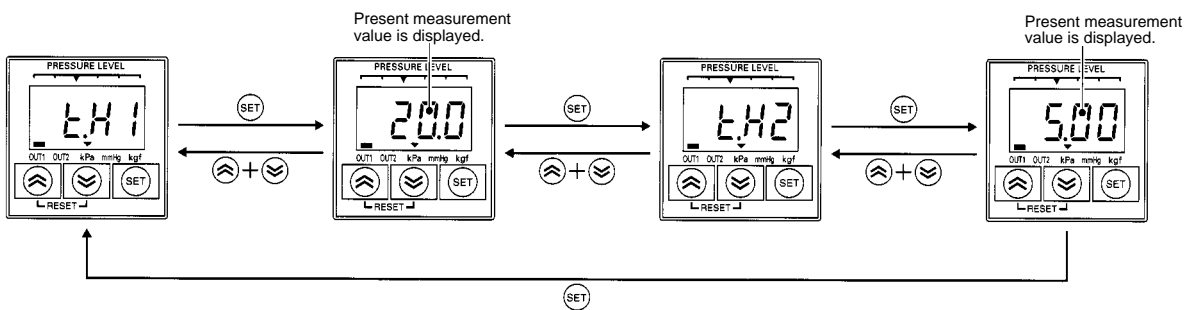

1. Press the SET Key under condition 1 below while L.H1 is displayed to display the present measurement value.
2. Check the measurement value and press the Set Key to perform and complete teaching the first point.
3. Press the Set Key under condition 2 below to display the present measurement value.

Two-point Teaching

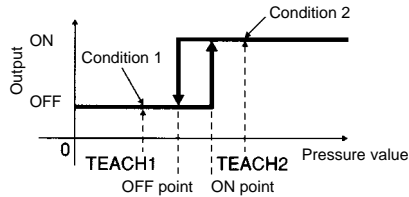

TEACH1 and TEACH2 can be performed in reverse order. TEACH1 value can be larger than TEACH2 value or vice versa.
 ON point: $(TEACH1 + TEACH2)/2$
 OFF point: ON point - 3% FS (default value)
 The default value is changeable.

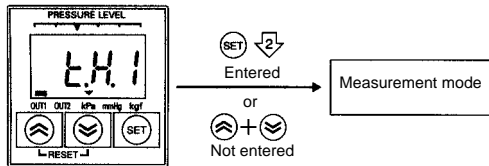

4. Check the measurement value and press the Set Key to perform and complete teaching the second point.
5. Press the SET Key for approximately 2 s while $L.H.I$ is displayed to enter the values and return the E8F2 to measurement mode.
6. Press the Up and Down Keys simultaneously to set the E8F2 to measurement mode without selecting the values.

Note: The E8F2 will be automatically set to hysteresis mode by performing two-point teaching.
 Two-point teaching is ideal for applications that check for vacuum attachment.

Auto-teaching

- One-point Teaching (Window-mode Teaching) OUT1

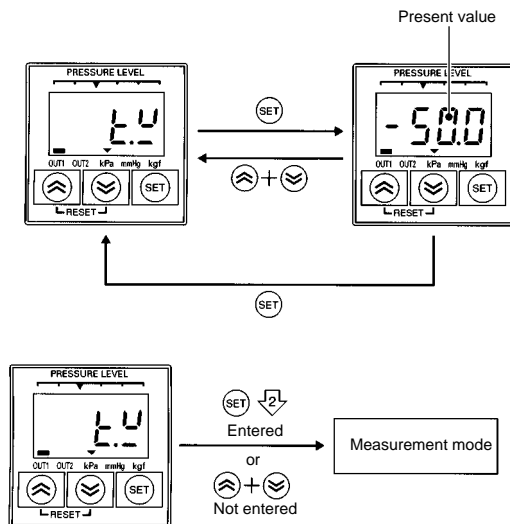

1. Press the SET Key under condition 3 below while $L.U$ is displayed to display the present measurement value.

One-point Teaching

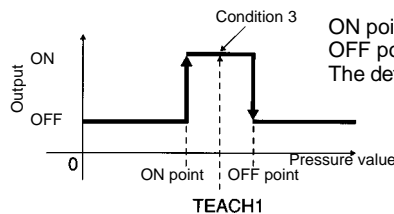

ON point: $TEACH1 - 30\% FS$
 OFF point: $TEACH1 + 30\% FS$
 The default value is 10% FS (changeable).

2. Check the measurement value and press the Set Key to perform and complete teaching.
3. The values are entered Press the SET Key for approximately 2 s while $L.U$ is displayed to enter the values and return the E8F2 to measurement mode.
4. Press the Up and Down Keys simultaneously to return the E8F2 to measurement mode without selecting the values.

Note: The E8F2 will be automatically set to window mode by performing one-point teaching.

One-point teaching is ideal for applications that check original pressure.

- Teaching Error

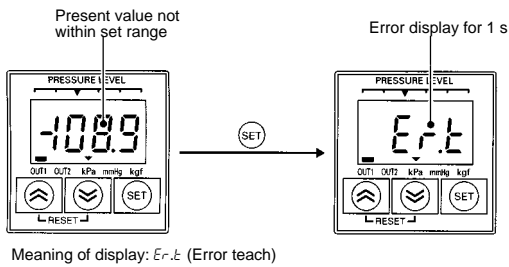

If the present value or the result of calculation after teaching is not within the range, the SET Key input will not be accepted. In this case an error will be displayed for 1 s if teaching is performed.

Special Setting Mode

Key-protect, hysteresis width, window width, display refresh interval, number of measurement times for averaging, and bar indicator range settings are set in special setting mode.

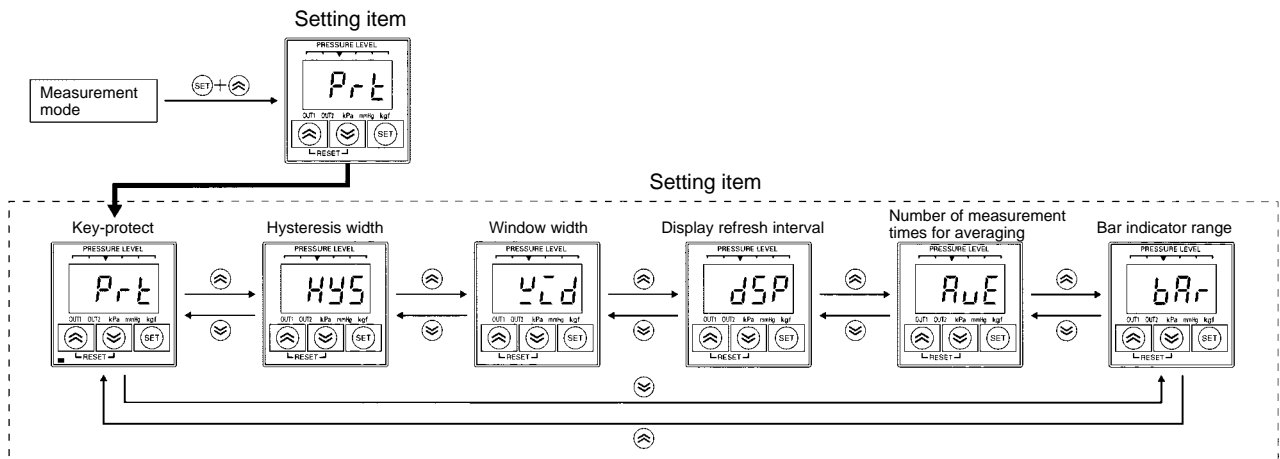

1. Press the SET Key and Up Key simultaneously to set the E8F2 to special setting mode and display *PrL*.
2. Set the Up or Down Key to select the items *PrL*, *HYS*, *Wd*, *dSP*, *Ave*, and *bAr*.

Key-protect Setting

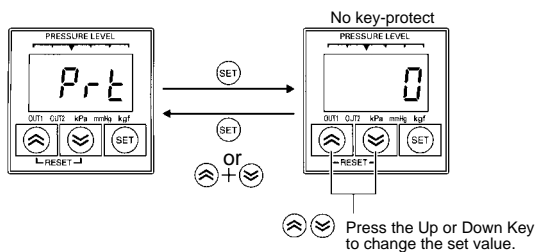

Key-protect Status

0: No key-protect.

1: No basic or pressure settings are accepted.

2: No input is accepted other than for checking the pressure value or special settings or setting to energy-saving mode.

1. Press the SET Key while *PrL* is displayed to display the key-protect value presently set.
2. Press the Up or Down Key to change the value.
3. Press the SET Key to select the displayed value and display *PrL* again.
4. Press the Up and Down Keys simultaneously display *PrL* again without selecting the value.

Hysteresis Width Setting

The hysteresis width can be changed by taking the following steps.

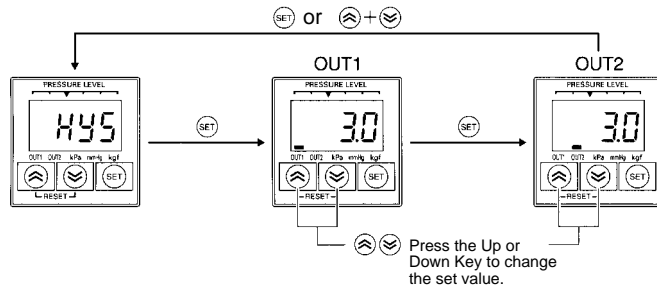

Hysteresis Mode

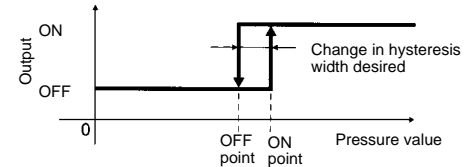

Window mode

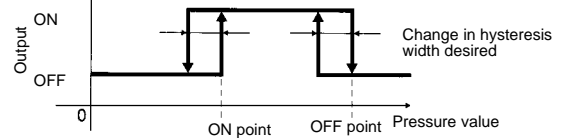

1. Press the SET Key while *HYS* is displayed to display the hysteresis width of OUT1 presently set.
2. Press the Up or Down Key to change the set value within a range between 0 and 10.0% FS.
3. Press the SET Key to select the displayed set value and display the hysteresis width of OUT2 presently set.
4. Press the Up or Down Key to change the set value.
5. Press the SET Key to select the displayed set value and display *HYS* again.
6. Press the Up and Down Keys simultaneously to display *HYS* again without selecting the value.

Note: 1. Hysteresis Mode

No manual hysteresis width settings are enabled in hysteresis mode except for those set by auto-teaching.

Window Mode

Hysteresis width settings are enabled when the E8F2 in window mode is set to measurement mode.

2. ON- and OFF-point widths in hysteresis mode are used as hysteresis widths, which cannot be changed in window mode.

Window Range Setting

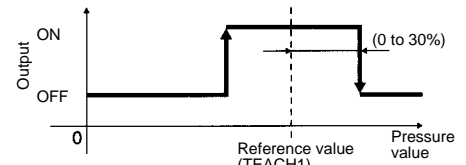
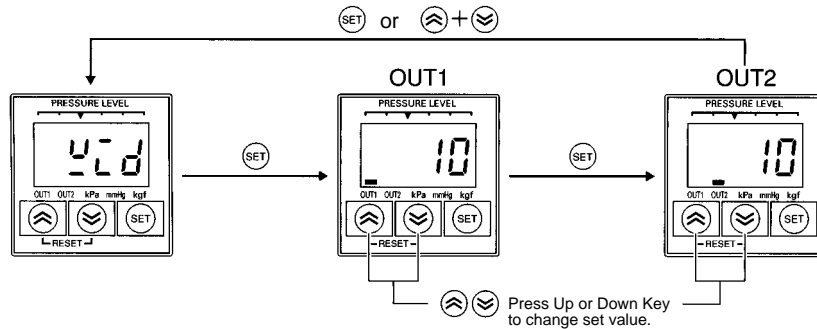

1. Press the SET Key while *Wd* is displayed to display the window width of OUT1 presently set.
2. Press the Up or Down Key to change the set value within a range between 0 and 30% FS of the reference value.
3. Press the SET Key to select the displayed set value and display the window width of OUT2 presently set.
4. Press the Up or Down Key to change the set value.
5. Press the SET Key to select the displayed set value and display *Wd* again.
6. Press the Up and Down Keys simultaneously to display *Wd* again without selecting the set value.

Note: No window width settings will be enabled in hysteresis mode.

Display Refresh Interval Setting

The following refresh intervals are selectable.

0.1: The average value is displayed at 0.1-s intervals.

0.5: The average value is displayed at 0.5-s intervals.

1.0: The average value is displayed at 1.0-s intervals.

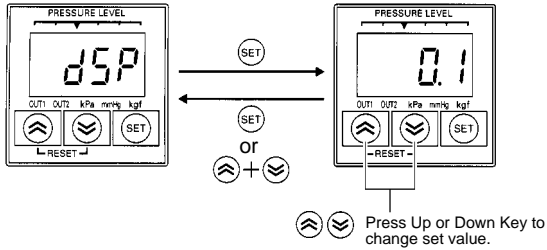

1. Press the SET Key while *dSP* is displayed to display the display refresh interval presently set.
2. Press the Up or Down Key to change the set value.
3. Press the SET Key to select the displayed set value and display *dSP* again.
4. Press the Up and Down Keys simultaneously to display *dSP* again without selecting the set value.

Note: Set the AVE to the number of measurements for obtaining an average value.

Measurement Value Averaging Time Setting

The number of measurements can be set to 1, 8, 32, or 256.

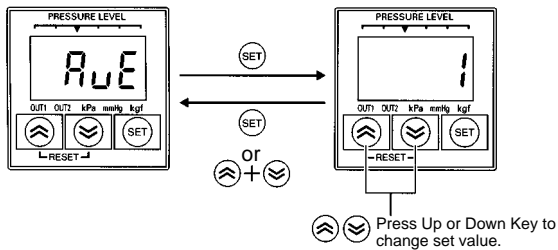

1. Press the SET Key while *AVE* is displayed to display the set value as the number of measurements for averaging measured values.
2. Press the Up or Down Key to change the set value.
3. Press the SET Key to select the displayed set value and display *AVE* again.
4. Press the Up and Down Keys simultaneously to display *AVE* again without selecting the set value.

Note: If the DSP item is set to 0.5 and AVE item is set to 32, the E8F2 will measure 32 times, the average value of which will be treated as one block. The average block value for 0.5 s will be displayed at 0.5-s intervals.

Bar Indicator Range Setting

The set value is an indication range per LED between 1 and 20% FS. If the E8F2 is set to AUT, the ideal display range will be set automatically according to the the ON point presently set.

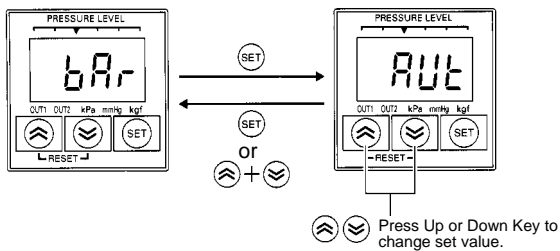

1. Press the SET Key while *bAr* is displayed to display the bar display range presently set.
2. Press the Up or Down Key to change the set value.
3. Press the SET Key to select the displayed set value and display *bAr* again.
4. Press the Up and Down Keys simultaneously to display *bAr* again without selecting the set value.

Note: The bar indicator range will be available to OUT1 output and will be enabled in hysteresis mode only.

Bar Indicator

The user can visually sense the measured pressure according to the ON and OFF points from the bar indicator. This indicator is available to OUT1 output only. There is a difference in indication mode between hysteresis mode and window mode.

- **Hysteresis Mode**

The five LEDs indicate the present pressure provided that the ON point is between the second and third LEDs from the left.

1-MPa Model (with 300 kPa as ON Point)

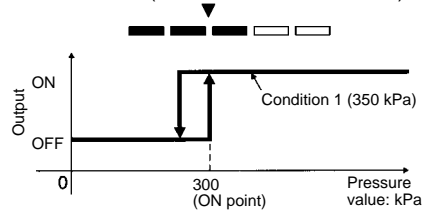

The indication range per LED is obtained from the following.

$$300 \text{ kPa} \leq 1 \text{ MPa} \times 1/2$$

$$300 \text{ kPa} \times 1/3 = 100 \text{ kPa}$$

The first through third LEDs from the left are all ON under condition 1. The indication range per LED is the set value of the indication range in special setting mode. If the set value is *AVE*, the following ranges are obtainable.

When ON point \leq Rated pressure $\times 1/2$

$$\text{Indication range per LED} = \text{ON point} \times 1/3$$

When ON point $>$ Rated pressure $\times 1/2$

$$\text{Indication range per LED} = (\text{Rated value} - \text{ON point}) \times 1/3$$

- **Window Mode**

The distance between ON and OFF points are divided into five equal portions. The present pressure will be indicated by a single LED that will be ON. The left LED will flash if the present pressure is below the ON point and the right LED will flash if the present pressure is above the OFF point.

1-Mpa Model (with 300 kPa as ON point and 600 kPa as OFF point)

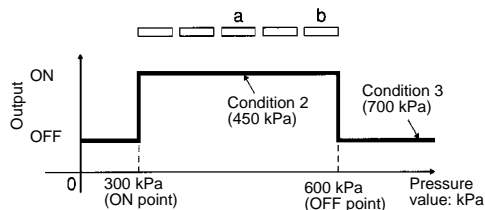

Only LED (a) will be lit under condition 2.

Only LED (b) will be lit under condition 3.

The display range per LED will be the following.

$$\text{Difference between ON and OFF points} \times 1/5$$

Note: No bar indicator settings in special setting mode will be enabled.

Returning to Measurement Mode

Setting Items

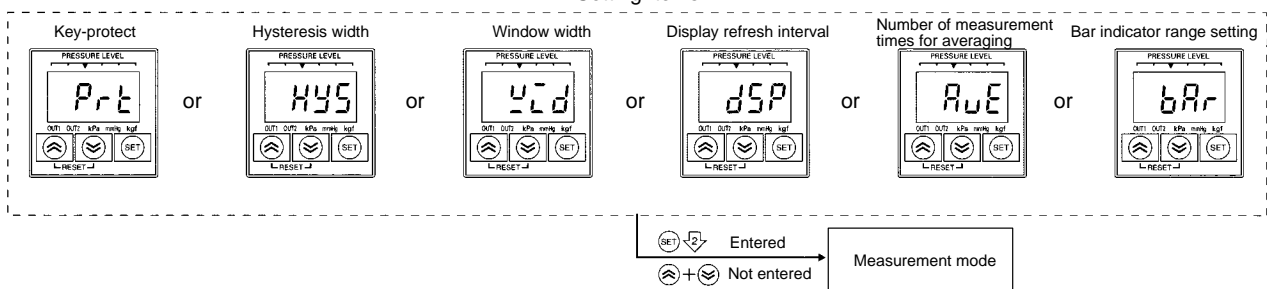

Entering Set Values:
Press the SET Key for approximately 2 s while the value is displayed.

Not Entering Set Values:
Press the Up and Down Keys simultaneously while the value is displayed.

Energy-saving Mode

The E8F2 has functions to save power by turning OFF the numeric and menu display and leaving the bar indicator turned ON.

Energy-saving Function 1

Normal Measurement Mode

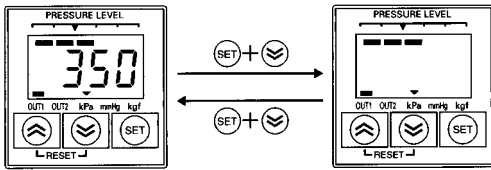

1. The numeric and menu display is turned OFF by pressing the SET and Down Keys simultaneously in measurement mode.
2. The display is turned ON by pressing the SET and Down Keys simultaneously again.

Energy-saving Function 2

If the present pressure is not within the set range, the numeric and menu display will flash as a warning.

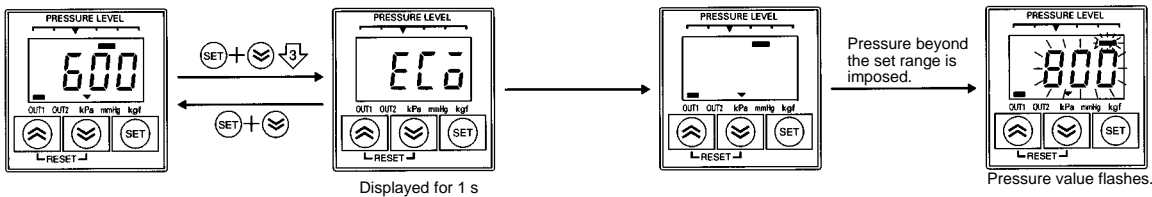

1. If the SET and Down Keys are pressed simultaneously for approximately 3 s in measurement mode, $E.C.$ will be displayed for 1 s and then the numeric and menu display will be turned OFF.
2. Provided that the E8F2 is set to window mode, the numeric and menu display will flash together with the bar indicator if the present pressure is below ON point or above the OFF point.
3. The numeric and menu display and the bar indicator return to normal condition by pressing the SET and Down Keys simultaneously.

ON- and OFF Set Value Check Function

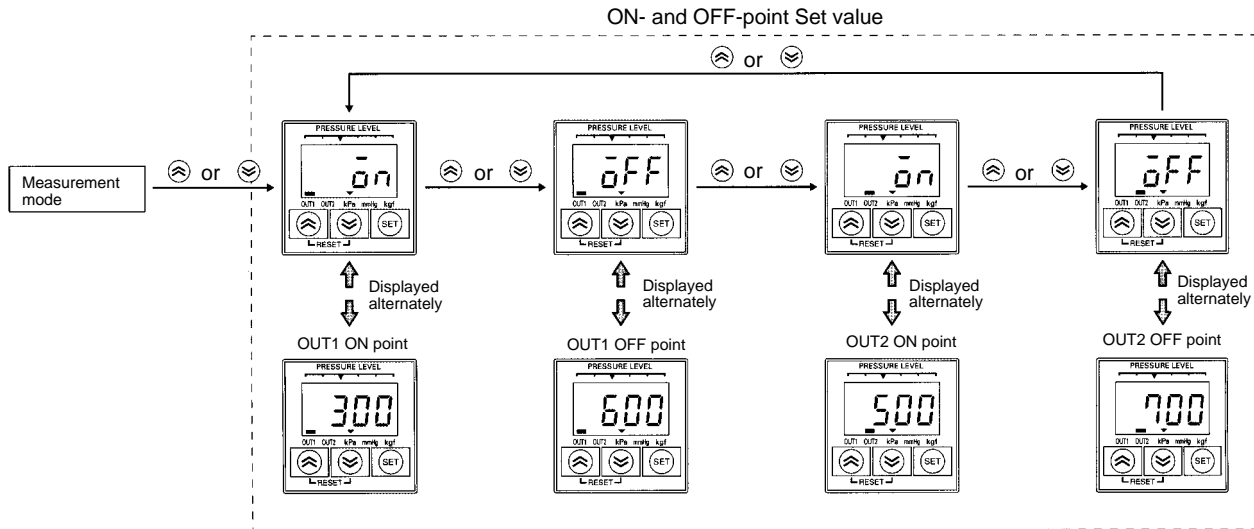

The ON and OFF points presently set can be checked.

Press the Up or Down Key in measurement mode to display the OUT1 ON point and $\bar{o}n$ alternately.

Press the Up or Down Key again to display the OUT1 OFF point and $\bar{o}ff$ alternately.

Press the Up or Down Key after the above to display the OUT2 items.

If no key is input for approximately 2 s during the above operation, the present measurement value will be displayed automatically.

Dimensions

Unit: mm (inch)

CONTROLLER

E8F2

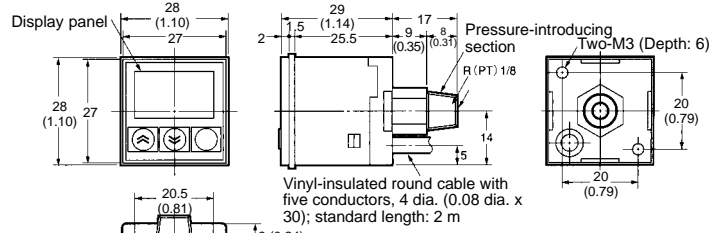
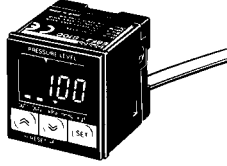

With Mounting Bracket

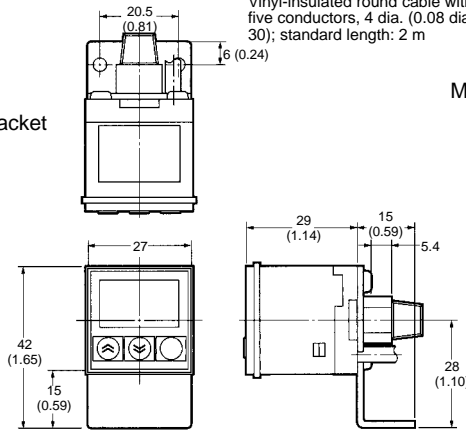

Mounting Dimensions

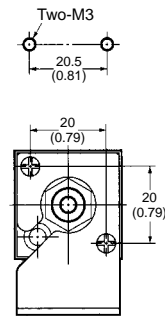

ACCESSORIES

E89-F3 Mounting Bracket

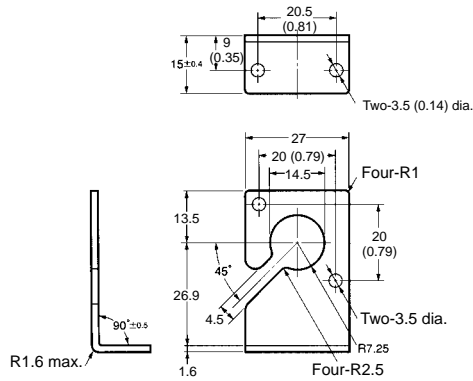
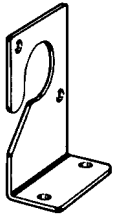

* Provided with E8F2

■ E89-F4 PANEL-MOUNTING BRACKET (SOLD SEPARATELY)

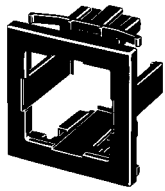

Panel Cutout Dimensions
(E89-F4 is available in the following two sizes.)

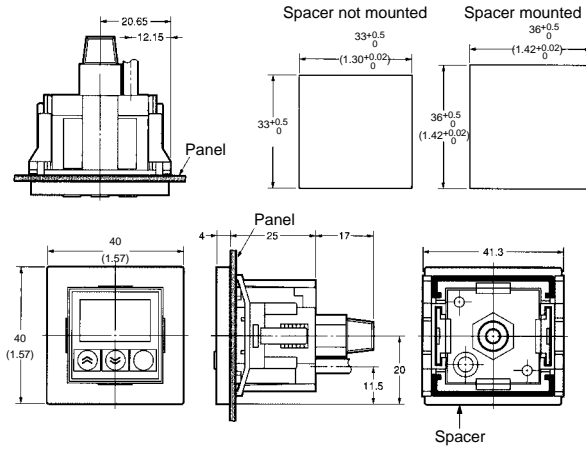

Note: The spacer can be removed from the panel-mounting bracket. The panel cutout dimensions can be adjusted as shown above by attaching or detaching the spacer.

Precautions

■ ENVIRONMENT

- Do not use the Sensor in locations subject to explosive or flammable gases.
- Do not use the Sensor in an environment subject to corrosive or combustible gases.
- Make sure that the Sensor is free of water.

■ AVOID DAMAGE TO THE E8F2

- Do not impose any voltage exceeding the rated voltage on the E8F2.
- Do not short-circuit the load connected to the E8F2.
- When supplying power to the E8F2, make sure that the polarity of the power is correct.

■ WIRING

- Do not wire power lines or high-tension lines adjacent to the lines of the E8F2.
- If no linear output is used, cut the gray lead wire short and apply insulating tape to the lead wire so that it will not come into contact with any other terminal.

■ MOUNTING

- Mount the Sensor so that ultrasonic vibrations will not be applied directly to the Sensor.
- Do not insert any wire into the pressure port. Doing so may damage the pressure elements and cause a malfunction.
- Do not apply a tensile strength in excess of 50 N to the cords or connectors.
- The pressure-introducing section (aluminum die-cast made) is fixed with tapered R(PT)1/8 male screws and M5 female screws. When using tapered screws, use tapered Rc(PT)1/8 female screws.
- Wrap the tapered R(PT)1/8 male screws with sealing tape to prevent any leakage. Tighten the male screws to a torque of 10 N • m max.
- Tighten M5 female screws to a torque of 2 N • m max.
- Tightening each male screw by using a 12-mm wrench to hold its hexagonal head, not the screw itself.

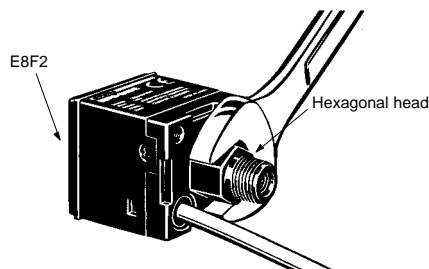

- When attaching the Mounting Bracket to the Sensor, make sure that each M3 screw is tightened to a torque of 0.5 N • m max.

■ USE

- Filter the gas with an appropriate air filter so that the applied gas will be free of moisture or oil.
- Be sure to use the Sensor under the rated pressure.
- When setting the set pressure of the ON or OFF point of the output transistor by pressing the mode selection key, use a manometer measures pressure if precise pressure settings are required. The Sensor has a display error of 3% FS \pm 1 digit at room temperature. Refer to *Specifications*.
- Reset Time: the Sensor is ready to operate 0.5 s after the Sensor is turned ON.

NOTE: DIMENSIONS SHOWN ARE IN MILLIMETERS. To convert millimeters to inches divide by 25.4.

OMRON[®]
OMRON ELECTRONICS, INC.
One East Commerce Drive
Schaumburg, IL 60173
1-800-55-OMRON

OMRON CANADA, INC.
885 Milner Avenue
Scarborough, Ontario M1B 5V8
416-286-6465

X-ON Electronics

Largest Supplier of Electrical and Electronic Components

Click to view similar products for [Industrial Pressure Sensors](#) category:

Click to view products by [Omron](#) manufacturer:

Other Similar products are found below :

[75380-05](#) [76053-00000300-01](#) [76053-00000300-05](#) [76061-00000015-01](#) [76062-B00000350-01](#) [76063-00000350-05](#) [76083-05000500-01](#)
[76311-05](#) [76577-00000070-01](#) [76584-M00000100-24](#) [77343-24.0H2-01](#) [77343-25.0H2-01](#) [78291-B00000060-01](#) [78303-B00000400-01](#)
[78303-B00000400-05](#) [78316-B00000030-01](#) [78353-B00000020-05](#) [78665-00000014-05](#) [78677-B00000070-05](#) [78678-00000040-01](#) [79279-](#)
[00000060-01](#) [79296-B00000350-01](#) [79322-00250035-01](#) [79614-30.0H2-14](#) [79670-00000090-15](#) [79700-00002750-01](#) [79917-B00000280-01](#)
[80569-00700100-01](#) [81509081](#) [81739-B00000900-01](#) [81807-B00000020-01](#) [MLH010BST01A](#) [MLH010BST14A](#) [MLH025BGC13B](#)
[MLH025BSCDJ1292](#) [MLH025BSCDJ1303](#) [MLH750PSCDJ1245](#) [82903-B00000020-01](#) [83250-02500600-05](#) [83271-00000040-04](#) [83278-](#)
[B00000200-21](#) [83286-00000150-01](#) [83299-00000150-05](#) [83303-00000600-01](#) [83305-00001350-01](#) [83330-00000100-01](#) [83349-00001470-24](#)
[83350-04.0HG-05](#) [83350-15.0H2-05](#) [83357-00000030-21](#)