

## Four-channel Input Controller for Control of Multiple Sensor Heads



 Be sure to read *Safety Precautions* on page 12.

### Ordering Information

#### Sensors

##### E8MS

	Pressure range	Output configuration	Model
Positive pressure	0 to 100 kPa	Linear output: 1 to 5 V	<b>E8MS-01</b>
	0 to 1 MPa		<b>E8MS-10</b>
Negative pressure	0 to -101 kPa		<b>E8MS-N0</b>
Compound pressure	-101 to 101 kPa		<b>E8MS-N1 *</b>

\* Do not connect the E8MS-N1 to a Controller. A Controller is not necessary.

##### E8M

	Pressure range	Output configuration	Model
Minute pressure differential	Differential pressure from 0 to 1,000 Pa between positive and negative ports	Linear output: 1 to 5 V	<b>E8M-A1-S</b>
Positive pressure	0 to 1 MPa		<b>E8M-10</b>
Negative pressure	0 to -101 kPa		<b>E8M-N0</b>



#### Controllers

Power supply voltage	Output configuration	Number of sensor inputs	Models
24 VDC	NPN open collector	4CH	<b>K3C-MP8 *</b>

\* The E8M-MP8 cannot be connected to the E8MS-N1.

## Accessories (Order Separately)

### Sensor I/O Connectors

Applicable model	Appearance	Model	Specifications	Unit	Remarks
E8M		<b>E89-M3-S *</b>	4-pin connector with 3-m-long cable	1	Provided with one XN2A-1430 e-CON Connector for Cable Connection.
E8MS		<b>E89-M4-S</b>	3-pin connector with 3-m-long cable		
E8MS/E80-C2		<b>E89-M4-1</b>	3-conductor, 3-m-long cable with connectors on both ends		Cannot be cut or extended.

\* E8M-A1 does not require the Sensor I/O Connector.

### e-CON Connector for Cable Connection

Appearance	Model	Applicable wire size (mm <sup>2</sup> )	Quantity	Minimum order unit	Remarks
	<b>XN2A-1430</b>	0.08 to 0.5	1	10	The E89-M3 and E89-M4 are each provided with one XN2A-1430.

### Power and Output Connector

Model	Specifications	Quantity
<b>E89-M5-S</b>	8-pin connector with 2-m cable	1

### Adapter

Model	Remarks
<b>Y92F-37-S</b>	One Adapter is attached to the E8M-MP8 Controller.

### Hard Protective Front Cover

Appearance	Model
	<b>Y92A-40-S</b>

### 48 x 48 Panel Hole Adapter

Appearance	Model
	<b>Y92F-48-S</b>

## Sensor and Controller Combinations

Use the Pressure Controllers in the following combinations. The E89-M3/M4 is required when using the Sensor as a single unit.

Model	E89-M3-S	E89-M4-S	E8M-MP8	E89-M5-S	E89-M4-1
<b>E8MS-01</b>	No	Yes	Yes	Yes	Yes
<b>E8MS-10</b>	No	Yes	Yes	Yes	Yes
<b>E8MS-N0</b>	No	Yes	Yes	Yes	Yes
<b>E8MS-N1 *</b>	No	No	No	No	Yes
<b>E8M-A1-S</b>	No	No	Yes	Yes	No
<b>E8M-10</b>	Yes	No	Yes	Yes	No
<b>E8M-N0</b>	Yes	No	Yes	Yes	No

Yes: Required No: Not required

\* Connect the E8MS-N1 to a E89-M4-S Sensor I/O Connector. Do not connect it to a Controller. A Controller is not necessary.

## Sensor and Controller Connection

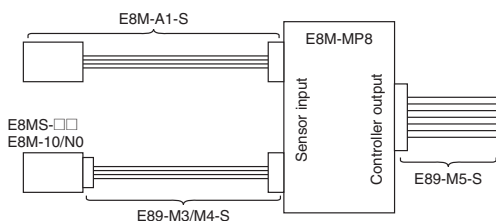

## Ratings and Specifications

### Sensors

#### E8MS

Item	Model	E8MS-01	E8MS-10	E8MS-N0	E8MS-N1
Power supply voltage		12 VDC $\pm$ 10%, ripple (p-p) of 5% max.			
Current consumption		25 mA max.			
Pressure type		Gauge pressure			
Applicable fluid		Non-corrosive gas and non-flammable gas			
Rated pressure range		0 to 100 kPa	0 to 1 MPa	0 to -101 kPa	-101 to 100 kPa
Withstand pressure		400 kPa	1.5 MPa	400 kPa	
Linearity		$\pm$ 1% FS max.			
Hysteresis		$\pm$ 1% FS max.			
Linear output		Voltage output: 1 to 5 V with an output impedance of 1 k $\Omega$			
Protection circuits		Reverse polarity protection, load short-circuit protection			
Ambient temperature range		Operating: 0 to 50°C Storage: -15 to 60°C (with no icing)			
Ambient humidity range		Operating/Storage: 35% to 85% (with no condensation)			
Temperature influence		$\pm$ 0.12% FS/°C max.			
Voltage influence		$\pm$ 1% FS max.			
Insulation resistance		100 M $\Omega$ min. (at 500 VDC) between current-carrying parts and case			
Dielectric strength		1,000 VAC for 1 minute			
Vibration resistance		Destruction: 10 to 150 Hz, 0.35-mm single amplitude or 50 m/s <sup>2</sup> , 10 times each for 8 min in X, Y and Z directions			
Shock resistance		Destruction: 500 m/s <sup>2</sup> 3 times each in X, Y and Z directions			
Degree of protection		IP50 (IEC60529)			
Pressure port		R (PT) 1/8 taper screw and M5 female screw			
Connection method		Connector			
Weight (packed state)		Approx. 6 g			
Material	Pressure port	Aluminum			
Accessories		Instruction manual			

## E8M

Item	Model	E8M-A1-S	E8M-10	E8M-N0
Power supply voltage	12 VDC $\pm$ 10%, ripple (p-p) of 5% max.			
Current consumption	30 mA max.			
Pressure type	Differential pressure		Gauge pressure	
Applicable fluid	Non-corrosive gas and non-flammable gas			
Rated pressure range	Differential pressure from 0 to 1,000 Pa between positive and negative ports		0 to 1 MPa	0 to -101 kPa
Withstand pressure	Differential pressure from 0 to 2,500 Pa between positive and negative ports *		1.5 MPa	400 kPa
Accuracy	$\pm$ 3% FS max.		$\pm$ 5% FS max.	
Linearity	$\pm$ 1% FS max.			
Hysteresis	$\pm$ 1% FS max.			
Linear output	Voltage output: 1 to 5 V with an output impedance of 1 k $\Omega$			
Protection circuits	Reverse polarity protection, load short-circuit protection			
Ambient temperature range	Operating: 0 to 40°C Storage: -15 to 50°C (with no icing)			
Ambient humidity range	Operating/Storage: 35% to 85% (with no condensation)			
Temperature influence	$\pm$ 0.25% FS/°C max.		$\pm$ 0.12% FS/°C max.	
Voltage influence	$\pm$ 3% FS max.			
Insulation resistance	100 M $\Omega$ min. (at 500 VDC) between current-carrying parts and case			
Dielectric strength	1,000 VAC for 1 minute			
Vibration resistance	Destruction: 10 to 150 Hz, 0.75-mm single amplitude or 100 m/s <sup>2</sup> , 4 times each for 8 min in X, Y and Z directions			
Shock resistance	Destruction: 300 m/s <sup>2</sup> 3 times each in X, Y and Z directions			
Degree of protection	IP50 (IEC60529)			
Pressure port	M5 female screw	R (PT) 1/8 and M5 female screw	M5 male screw	
Connection method	Pre-wired cable (standard length: 3 m)		Connector	
Weight (packed state)	Approx. 130 g		Approx. 30 g	Approx. 20 g
Material	Pressure port	Stainless steel (SUS303)		Stainless steel (SUS304)
	Case	ABS		Aluminum, polyether sulfonic resin
Accessories	Pin Controller Connector, instruction manual		Instruction manual	

\* The absolute pressure value of each port is 100 kPa.

Measurement method

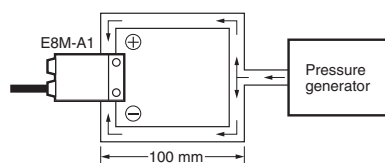

## Controllers

Item	Model	E8M-MP8			
Connectable Pressure Sensor	E8M-A1-S *	Differential pressure from 0 to 1,000 Pa between positive and negative ports	E8MS-01 (0 to 100 kPa)	E8MS-10 E8M-10 (0 to 1 MPa)	E8MS-N0 E8M-N0 (0 to -101 kPa)
Power supply voltage	24 VDC $\pm$ 10%, ripple (p-p) of 10% max.				
Current consumption	200 mA max. (including sensor section current consumption of 30 mA per channel)				
Sensor power supply	Supplied from the Controller, 12 VDC $\pm$ 10% (30 mA max. per channel)				
Input	Sensor input (through 4-pin one-touch connector)	Input voltage range: 1 to 5 VDC with an impedance of 800 k $\Omega$ per channel			
Output	Comparative output	NPN open collector Maximum load current: 80mA max. Load voltage: 30 VDC max. Residual voltage: 0.8 V max. with a flow current of 30 mA, 0.4 V max. with a flow current of 16 mA NO or NC (selectable) independent output in hysteresis or window mode (selectable) on each channel			
Autoshift input	Non-voltage input (contact or non-contact), Input: 10 ms min.				
Indicators	Measurement value	LED indicator (orange) with a character height of 9 mm for 4 digits.			
	Message	LED indicator (orange) with a character height of 9 mm for 4 digits.			
	Measurement and setting channel	LED indicator (red) with a character height of 5 mm for 1 digit.			
	Comparative output	LED indicator (red) that is lit when the output transistor is turned ON			
	Others	LED indicator (green) for connecting channel and unit display (green)			
Response speed	5 ms max. (The response speed will switch to 20 ms, 160 ms, or 640 ms when chattering prevention is enabled.)				
Set resolution	$\pm$ 0.1% FS max.				
Display accuracy	$\pm$ 0.5% FS $\pm$ 1 digit max. (at ambient temperature of 25°C)				
Protection circuits	Reverse polarity protection, load short-circuit protection				
Ambient temperature range	Operating: 0 to 50°C Storage: -20 to 60°C (with no icing)				
Ambient humidity range	Operating/Storage: 35% to 85% (with no condensation)				
Temperature influence	$\pm$ 0.5 FS max. (25°C reference)				
Insulation resistance	100 M $\Omega$ min. (at 500 VDC) between current-carrying parts and case				
Dielectric strength	1,000 VAC for 1 min				
Vibration resistance	Destruction: 10 to 150 Hz, 0.75-mm single amplitude or 100 m/s <sup>2</sup> , 4 times each for 8 min in X, Y and Z directions (with power supplied)				
Shock resistance	Destruction: 300 m/s <sup>2</sup> 3 times each in X, Y and Z directions (with power supplied)				
Degree of protection	IEC 60529, Front surface only: IP65 (when panel mounted), Otherwise: IP30				
Connection method	Panel mounting Power supply and output: 8-pin terminal Sensor I/O: 4-pin e-CON connector				
Weight	Approx. 55 g (not including accessories)				
Accessories	Instruction manual, Adapter, Water-proof Packing				

\* Pressure differentials are displayed with a minus (-) sign.

Engineering Data (Typical)

Linear Output Voltage vs. Pressure

E8MS-01

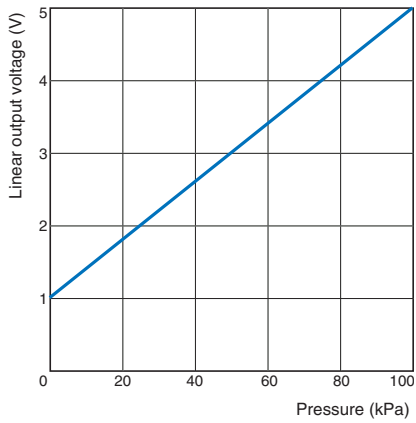

E8MS-10/E8M-10

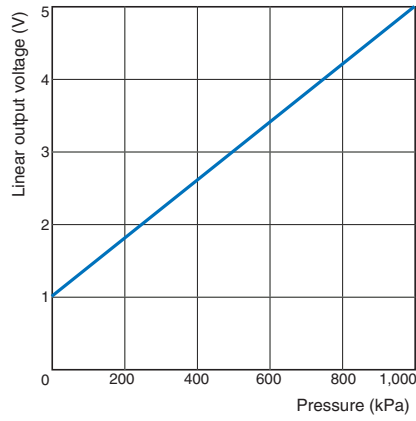

E8MS-N0/E8M-N0

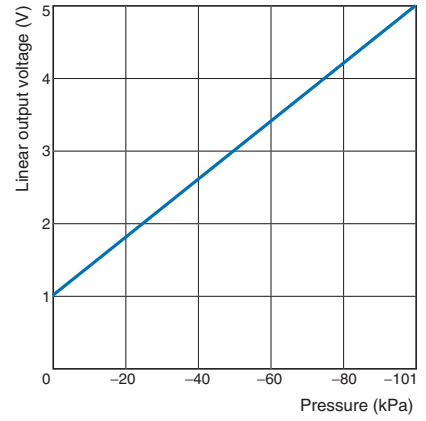

E8M-A1-S

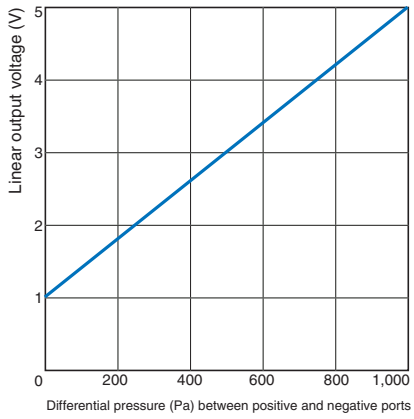

E8MS-N1

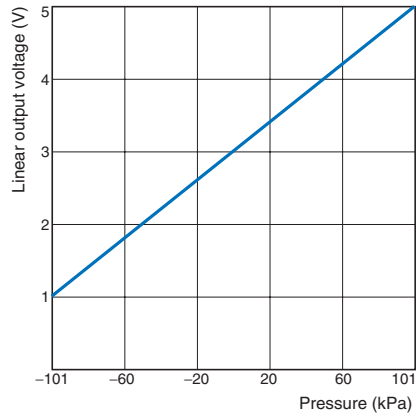

## Output Linearity

### E8MS-01

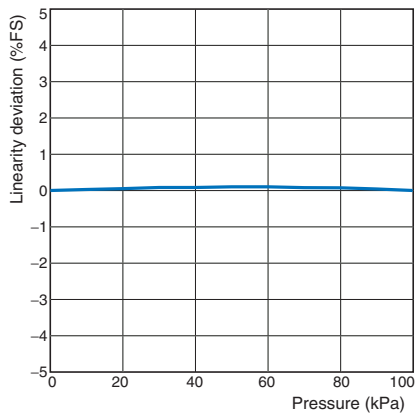

### E8MS-10/E8M-10

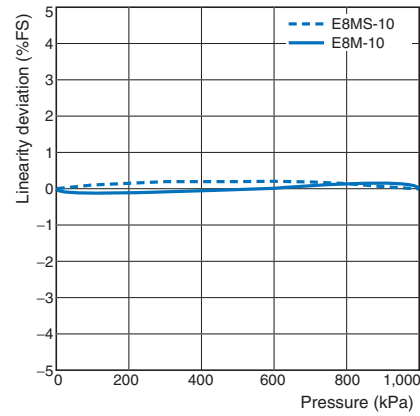

### E8MS-N0/E8M-N0

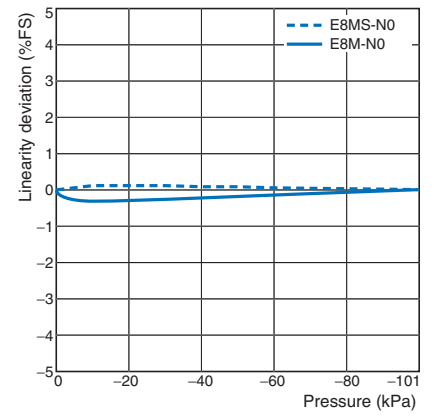

### E8M-A1

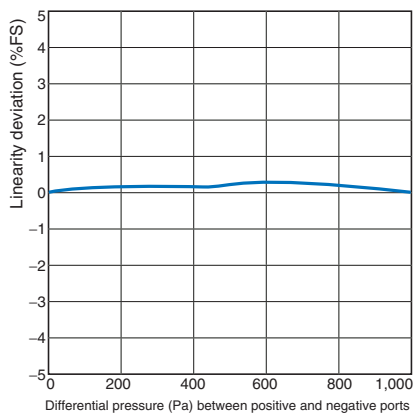

### E8MS-N1

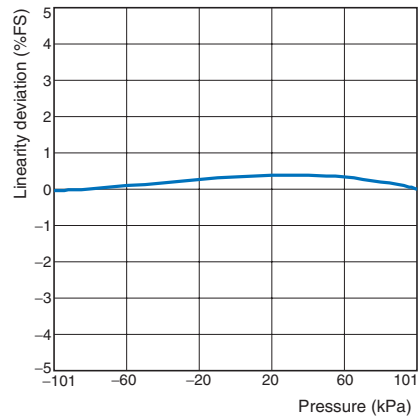

## Linear Output Fluctuation vs. Voltage

**E8MS-01**

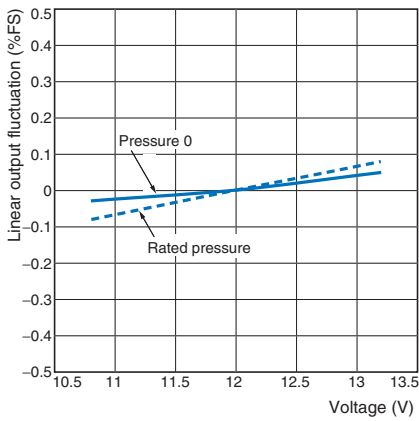

**E8MS-10**

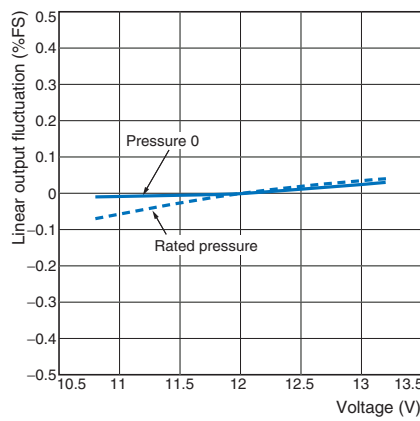

**E8MS-N0**

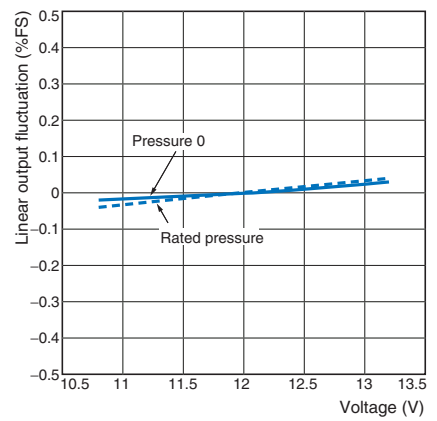

**E8M-A1-S**

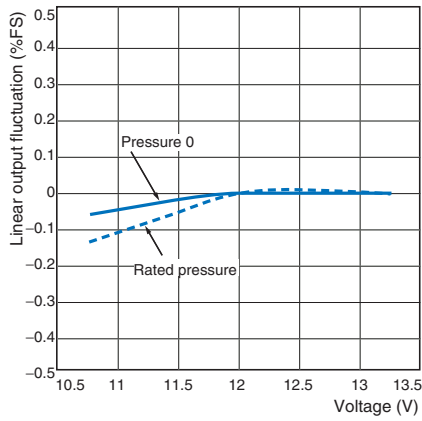

**E8M-10**

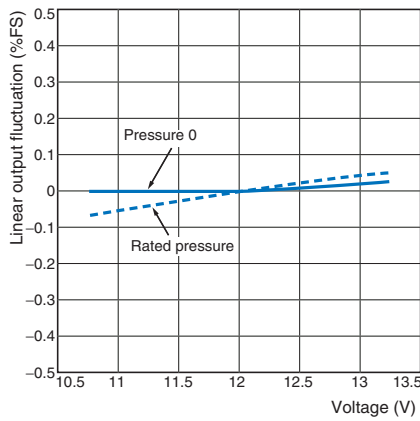

**E8M-N0**

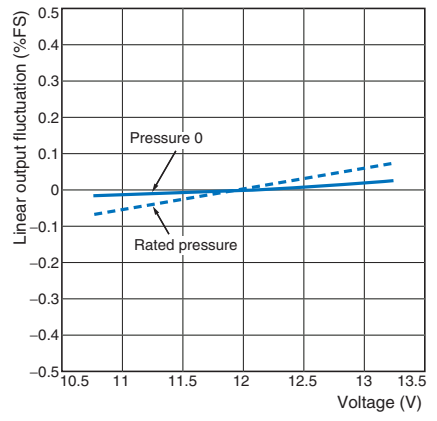

**E8M-N1**

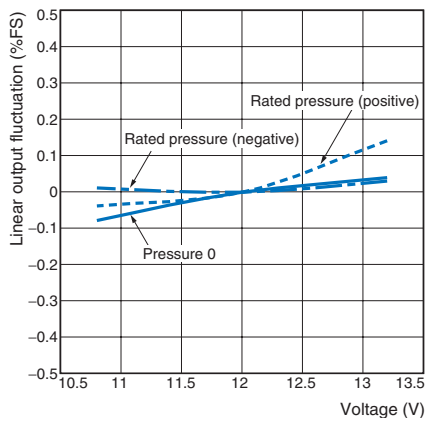



Linear Output Fluctuation vs. Temperature

E8MS-01

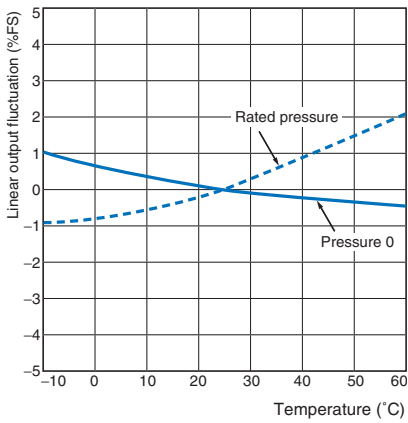

E8MS-10

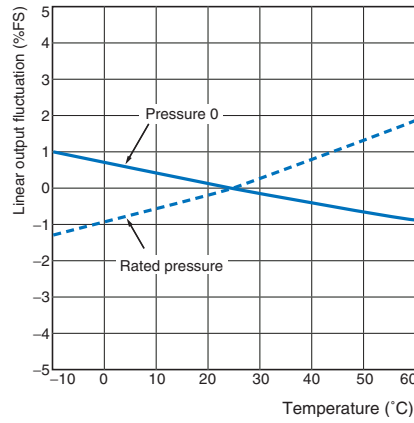

E8MS-N0

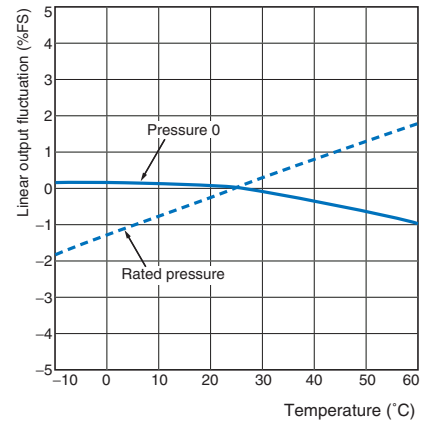

E8M-A1-S

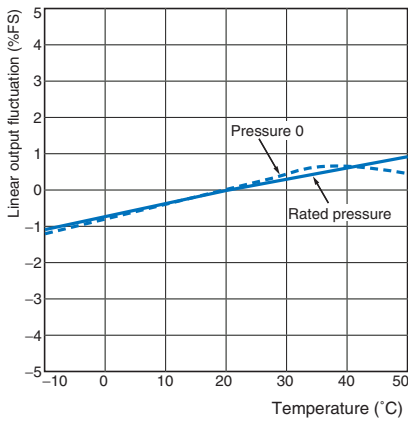

E8M-10

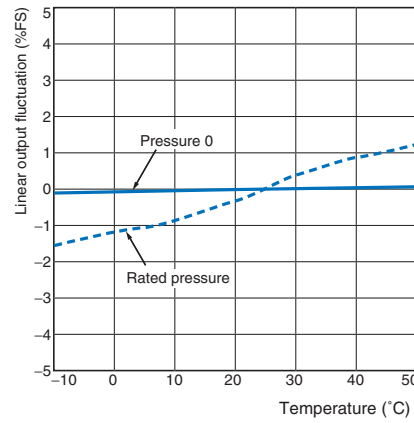

E8M-N0

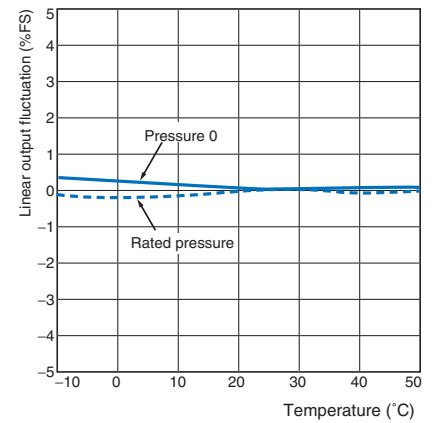

E8MS-N1

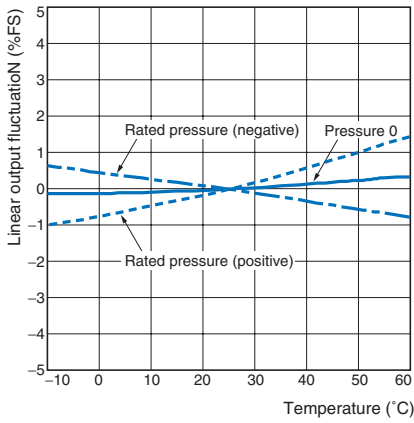

I/O Circuit Diagrams

Sensor

Output configuration	Model	Output circuit
1 to 5 V linear output	E8MS-01 E8MS-10 E8MS-N0 E8MS-N1	
	E8M-A1-S	
	E8M-10 E8M-N0	

\* Input for lighting the power supply indicator.  
5 V supplied: lit, 0 V: not lit

Controller

Output configuration	Model	Output circuit
NPN output	E8M-MP8	

Note: The wire colors shown on the left are the wire colors of the E89-M5-S (Controller power supply/output connector cables).

## Nomenclature

### Pressure Sensor Controller

#### E8M-MP8

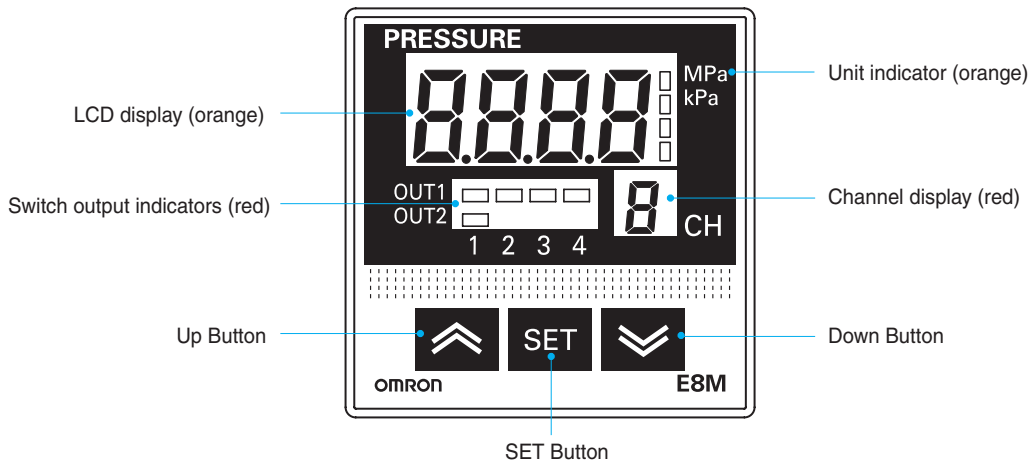

- Switch output indicators (red): Lit when OUT1 (CH1 to CH4) and OUT2 (CH1 only) are ON.
- LCD display (orange): Displays the present pressure status, setting mode status, display unit, and error code.
- Up Button: Used to select the mode and increase ON/OFF set values.
- Down Button: Used to select the mode and decrease ON/OFF set values.
- SET Button: Used to change modes and enter set values.
- Unit indicators (orange): The selected unit indicator will light. Only the SI units (i.e., Mpa or kPa) can be used.
- Channel display (red): The channel selected from CH1 to CH4 is displayed.

### Accessories

Panel Mounting Adapter . . . . . Y92F-37-S (M3 x 8L, two provided)

### Options

Power and Output Connector Cable (2 m) . . . . . E89-M5-S

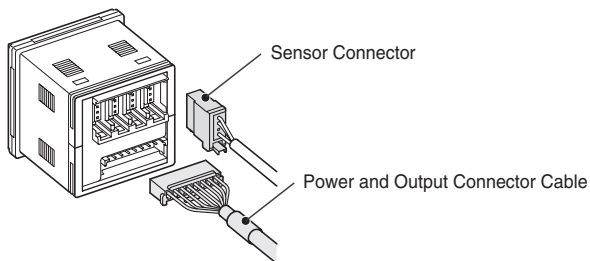

Protective Front Cover . . . . . Y92A-40-S

48 x 48 Adapter . . . . . Y92F-48-S

(This Adapter is to mount the E8M-MP8 in the panel cutout dimensions for the K3C Series.)

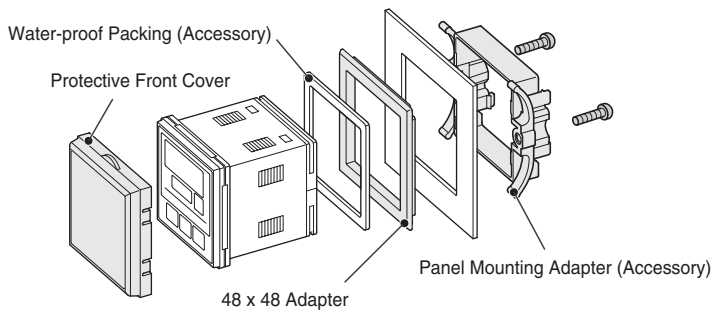

## Safety Precautions

Refer to *Warranty and Limitations of Liability*.

### ⚠ WARNING

This product is not designed or rated for ensuring safety of persons either directly or indirectly.  
Do not use it for such purposes.



### Precautions for Correct Use

Do not use this product in atmospheres or environments that exceed product ratings.

#### ● Installation

#### Connecting and Locking the E8MS Sensor I/O Connector (E89-M4)

- (1) Hold both ends of the female connector connected to the Sensor I/O Connector so that the protrusion on the female connector faces upward, orientate the hole in the male connector on the Sensor upwards, and insert the female connector into the hole until the protrusion clicks in.

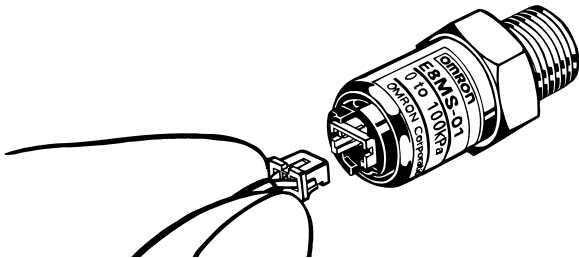

- (2) A lock cover is slid through the Sensor I/O Connector to prevent it from coming free due to vibration or shock. Insert the lock cover facing in the correct direction (a) as shown in the following figure, and rotate it clockwise (b) until it clicks in.

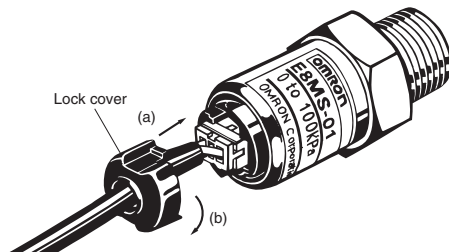

- (3) To unlock the connector, rotate the lock cover counterclockwise until it clicks, then pull it towards you. To disconnect the connector, hold both ends of the connector, then pull it towards you.

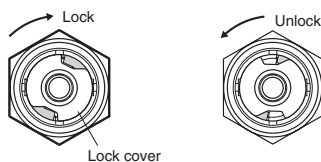

Note: Forcibly pulling the cable to disconnect the connector may damage the pressure-welded portion. Be sure to hold both ends of the connector when disconnecting it.

#### Other Installations

##### E8MS-□□/E8M-10

- (1) The pressure-introducing section (aluminum for E8MS, SUS304 for E8M) is fixed with tapered R(PT)1/8 male screws and M5 female screws.
- (2) When using tapered screws, use tapered Rc(PT)1/8 female screws. Wrap the tapered R(PT)1/8 male screws with sealing tape to prevent any leakage. Tighten the male screws to a torque no more than 3.9 N·m.
- (3) Tighten M5 female screws to a torque no more than 1 to 1.5 N·m.
- (4) When tightening a screw, hold by its hexagonal head, not by its body.

##### E8M-N0

- (1) The pressure port (SUS304) is fixed with M5 male screws.
- (2) Tighten male screws to a torque no more than 1 to 1.5 N·m.
- (3) When tightening a male screw, hold by its hexagonal head, not by its body.

##### E8M-A1-S

- (1) The pressure port (SUS303) is fixed with M5 female screws (7 mm deep).
- (2) Tighten screws for the pressure port to a torque no more than 1 to 1.5 N·m.
- (3) M4 female screws are used for the product mounting sections.
- (4) When mounting the product, tighten the screws while holding a metal part of the product, not a resin part.
- (5) Tighten the product mounting screws to a torque no more than 1.2 N·m.
- (6) If the positive pressure section is released and positive pressure is applied to the negative pressure section, a positive pressure may be displayed.

##### E8M-MP8

- (1) Install the Sensor horizontally.
- (2) The recommended panel thickness is 0.5 to 8 mm.
- (3) Do not install the Sensor in an environment subject to strong vibration or shock.
- (4) Do not install the Sensor under dusty conditions.
- (5) Do not install the Sensor in an environment subject to corrosive gases, particularly sulfide and ammonia gases.
- (6) Do not install the Sensor near equipment that generates strong high-frequency noise such as high-frequency welders or sewing machines.

## ● Installation

### Connector Assembly Procedure

#### 1. Processing the Sensor I/O Connector Cable End

(1) The cable end is semi-stripped.

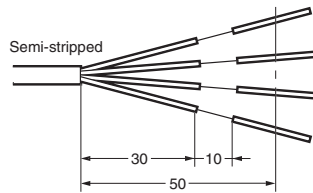

(2) Cut the ends as shown in the illustration on the right, and do not peel the shield.

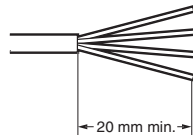

#### 2. Connecting the Sensor Cable and Connector

• Terminal numbers are engraved on the Sensor Connector. Refer to the following chart and be sure that the terminal numbers correspond to the wire colors and insert the wires all the way in.

Model	E89-M4-S	E89-M3-S
Terminal No.	I/O code	
1	Brown (Vcc)	
2	-----	Pink (LED lighting input)
3	Blue (GND)	
4	Black (IN: 1 to 5 V)	

### Wire Preparation

Strip 7 to 8 mm of the wire insulation as shown by the strip gauge on the side of the connector and twist stranded wires several times.

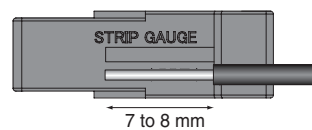

### Connection Procedure

(1) Use a flat-blade screwdriver to press in the operating lever in the operating hole until the lever locks.

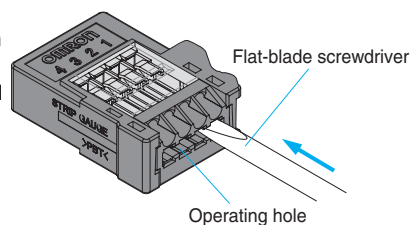

(2) Insert the wire all the way into the wire insert hole. Make sure that the insulated part of the wire is in the wire insert hole and that the end of the wire passes through the wire connection section.

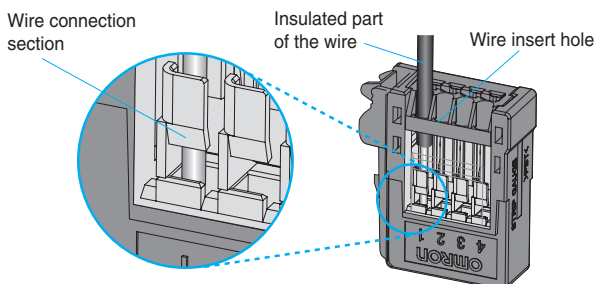

(3) Insert a flat-blade screwdriver into the release hole and lightly pull back the lever. The lever will be released when a click is heard.

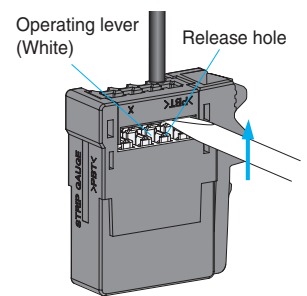
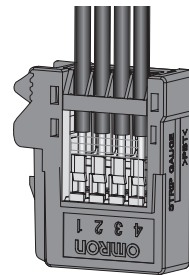

(3) Last, check the following points.

- The operating lever is released.
- Check step 2 again. (Lightly pull on the wires. If there is resistance, the wires are connected.)

### Connection Release Procedure

(1) Press in the operating lever, check that it is locked, and then pull out the wire.  
 (2) Be sure to release the operating lever after releasing the wire. If, however, wiring will be performed after releasing the connection, perform the wiring without releasing the operating lever.

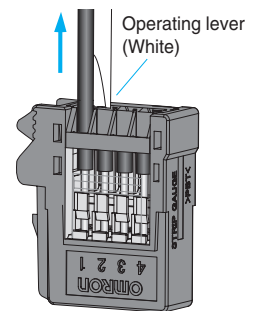

### ● Others

- (1) Do not use the Sensor in an environment subject to corrosive or combustible gases.
- (2) Do not use the Sensor alongside a high-tension voltage line or power line.
- (3) Do not expose the Sensor to water.
- (4) Be sure to use the Sensor under the rated pressure.
- (5) Do not insert any wire into the pressure port. Doing so may damage the pressure elements and cause a malfunction.
- (6) Do not apply any tensile strength in excess of 20N for E8MS, 30N for E8M to the cables or connectors.
- (7) Compressor oil and air-borne water may form droplets at the pressure receiving section of the Sensor. Remove the oil and water using an air filter to prevent damage to Sensor elements.
- (8) Do not pull the cables. When removing the connectors for external connection, be sure to use the lock lever.

## Dimensions

### Main Unit Sensors

E8MS-01  
E8MS-10  
E8MS-N0  
E8MS-N1

Connection with E89-M4 Sensor I/O Connector

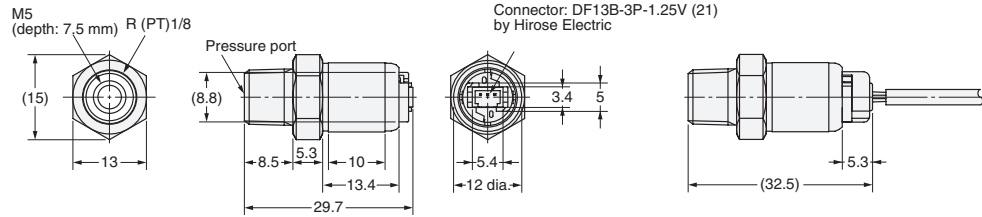
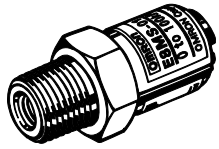

E8M-A1-S

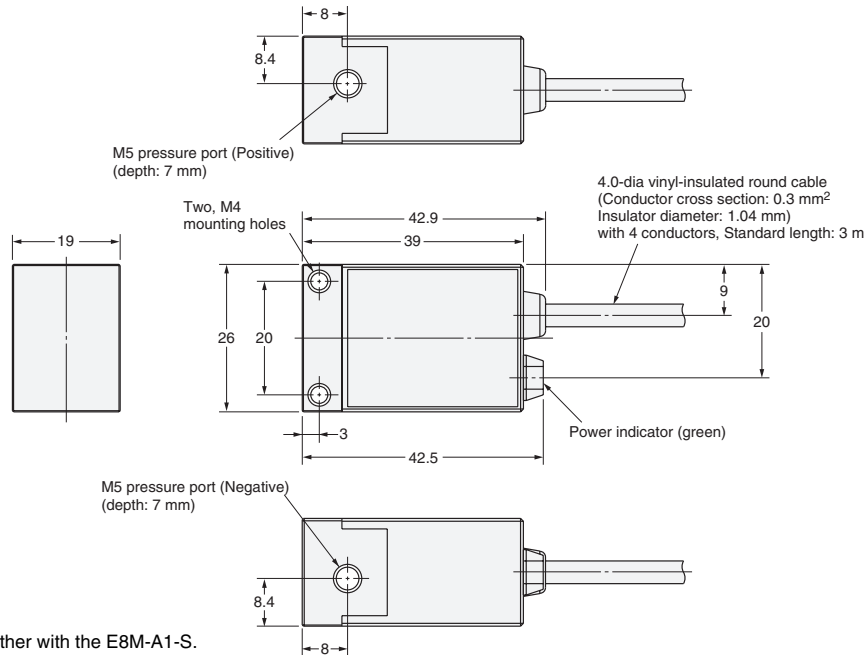
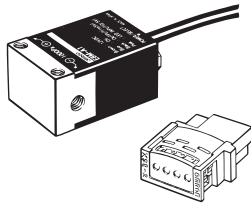

Note: One XN2A-1430 is supplied together with the E8M-A1-S.

E8M-10

Connection with E89-M3-S Sensor I/O Connector

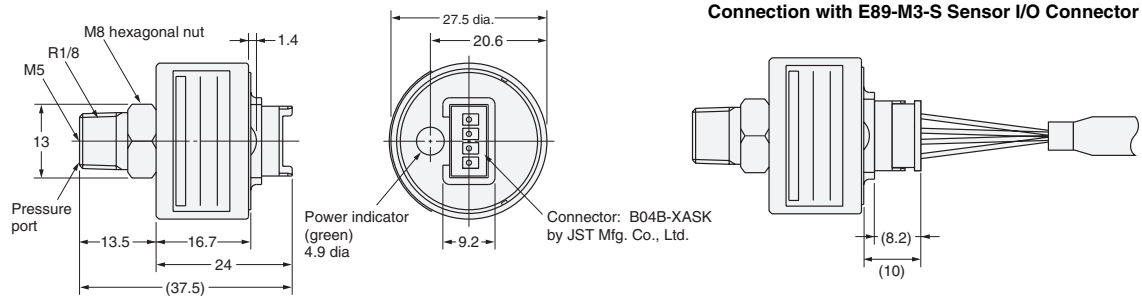
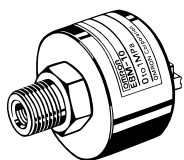

E8M-N0

Connection with E89-M3-S Sensor I/O Connector

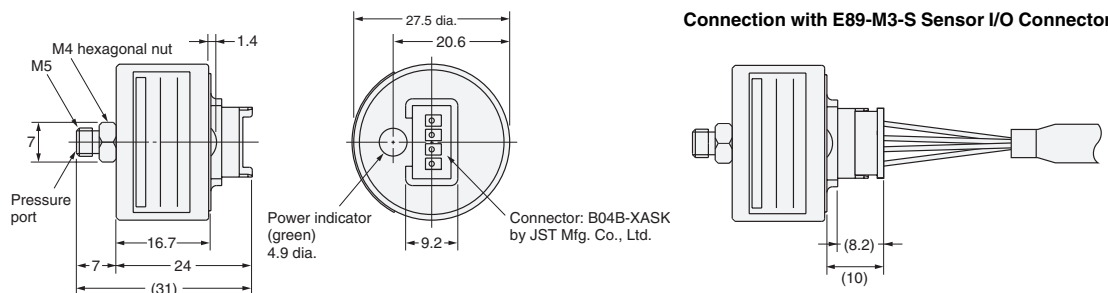
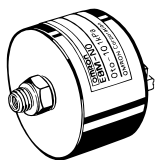

## Controller

### E8M-MP8

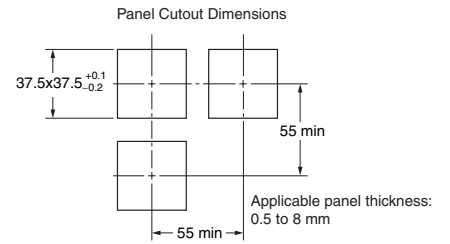
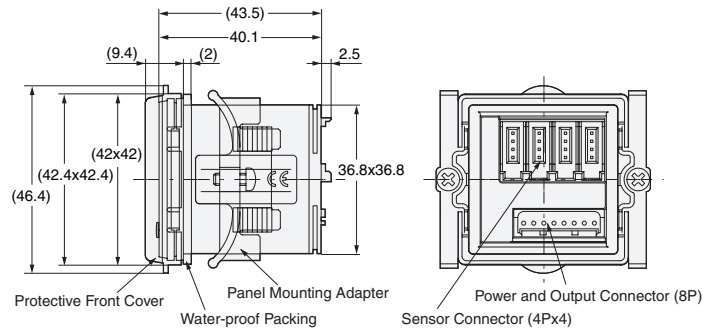
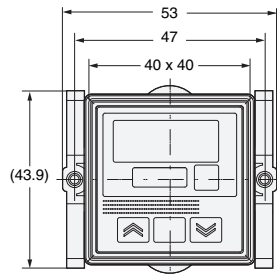
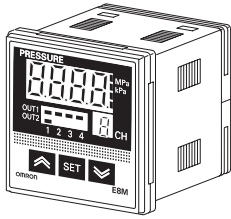

## Accessories (Order Separately)

### Sensor I/O Connector

#### For the E8M Only

#### E89-M3-S

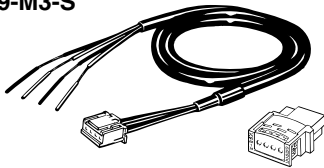

Note: One XN2A-1430 is provided with the E89-M3-S.

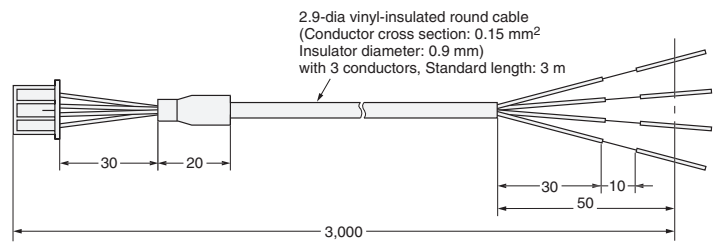

#### For the E8MS Only

#### E89-M4-S

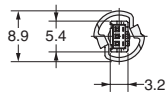
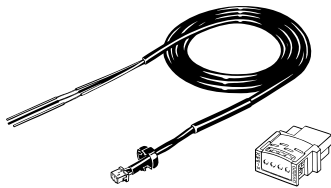

Note: One XN2A-1430 is provided with the E89-M4-S.

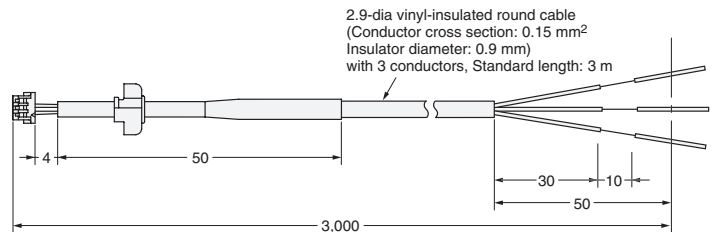

**Power and Output Connector**

**E89-M5-S**

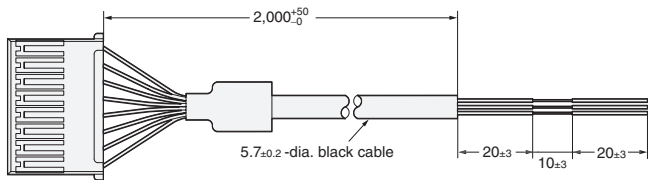

**Cable Connector**

**XN2A-1430**

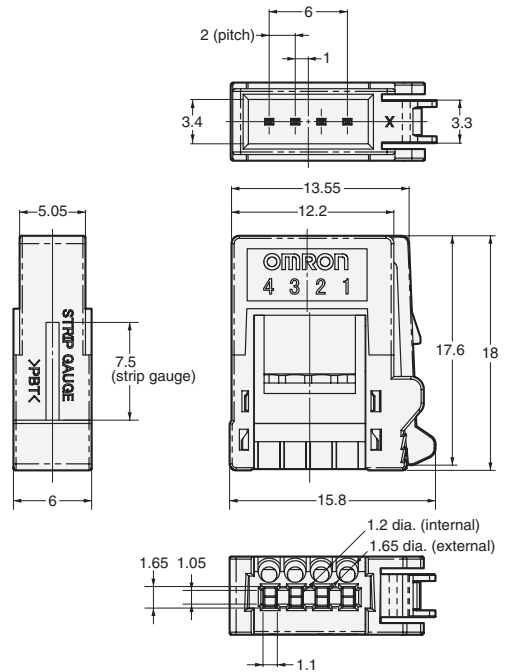

Note: One Connector is provided with the E89-M3-S or E89-M4-S.

**Adapter**

**Y92F-37-S**

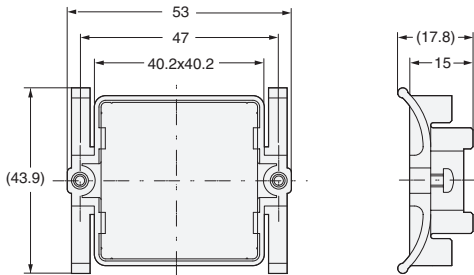

Note: One Y92F-37-S is provided with the E8M-MP8.

**Hard Protective Front Cover**

**Y92A-40-S**

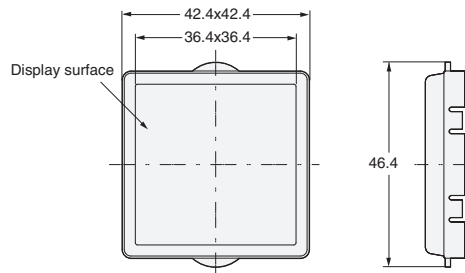

**48x48 Panel Hole Adapter**

**Y92F-48-S**

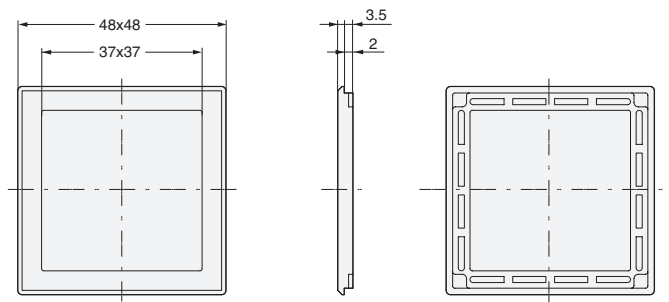



## Read and Understand This Catalog

Please read and understand this catalog before purchasing the products. Please consult your OMRON representative if you have any questions or comments.

## Warranty and Limitations of Liability

### WARRANTY

OMRON's exclusive warranty is that the products are free from defects in materials and workmanship for a period of one year (or other period if specified) from date of sale by OMRON.

OMRON MAKES NO WARRANTY OR REPRESENTATION, EXPRESS OR IMPLIED, REGARDING NON-INFRINGEMENT, MERCHANTABILITY, OR FITNESS FOR PARTICULAR PURPOSE OF THE PRODUCTS. ANY BUYER OR USER ACKNOWLEDGES THAT THE BUYER OR USER ALONE HAS DETERMINED THAT THE PRODUCTS WILL SUITABLY MEET THE REQUIREMENTS OF THEIR INTENDED USE. OMRON DISCLAIMS ALL OTHER WARRANTIES, EXPRESS OR IMPLIED.

### LIMITATIONS OF LIABILITY

OMRON SHALL NOT BE RESPONSIBLE FOR SPECIAL, INDIRECT, OR CONSEQUENTIAL DAMAGES, LOSS OF PROFITS OR COMMERCIAL LOSS IN ANY WAY CONNECTED WITH THE PRODUCTS, WHETHER SUCH CLAIM IS BASED ON CONTRACT, WARRANTY, NEGLIGENCE, OR STRICT LIABILITY.

In no event shall the responsibility of OMRON for any act exceed the individual price of the product on which liability is asserted.

IN NO EVENT SHALL OMRON BE RESPONSIBLE FOR WARRANTY, REPAIR, OR OTHER CLAIMS REGARDING THE PRODUCTS UNLESS OMRON'S ANALYSIS CONFIRMS THAT THE PRODUCTS WERE PROPERLY HANDLED, STORED, INSTALLED, AND MAINTAINED AND NOT SUBJECT TO CONTAMINATION, ABUSE, MISUSE, OR INAPPROPRIATE MODIFICATION OR REPAIR.

## Application Considerations

### SUITABILITY FOR USE

OMRON shall not be responsible for conformity with any standards, codes, or regulations that apply to the combination of products in the customer's application or use of the products.

At the customer's request, OMRON will provide applicable third party certification documents identifying ratings and limitations of use that apply to the products. This information by itself is not sufficient for a complete determination of the suitability of the products in combination with the end product, machine, system, or other application or use.

The following are some examples of applications for which particular attention must be given. This is not intended to be an exhaustive list of all possible uses of the products, nor is it intended to imply that the uses listed may be suitable for the products:

- Outdoor use, uses involving potential chemical contamination or electrical interference, or conditions or uses not described in this catalog.
- Nuclear energy control systems, combustion systems, railroad systems, aviation systems, medical equipment, amusement machines, vehicles, safety equipment, and installations subject to separate industry or government regulations.
- Systems, machines, and equipment that could present a risk to life or property.

Please know and observe all prohibitions of use applicable to the products.

NEVER USE THE PRODUCTS FOR AN APPLICATION INVOLVING SERIOUS RISK TO LIFE OR PROPERTY WITHOUT ENSURING THAT THE SYSTEM AS A WHOLE HAS BEEN DESIGNED TO ADDRESS THE RISKS, AND THAT THE OMRON PRODUCTS ARE PROPERLY RATED AND INSTALLED FOR THE INTENDED USE WITHIN THE OVERALL EQUIPMENT OR SYSTEM.

### PROGRAMMABLE PRODUCTS

OMRON shall not be responsible for the user's programming of a programmable product, or any consequence thereof.

## Disclaimers

### CHANGE IN SPECIFICATIONS

Product specifications and accessories may be changed at any time based on improvements and other reasons.

It is our practice to change model numbers when published ratings or features are changed, or when significant construction changes are made. However, some specifications of the products may be changed without any notice. When in doubt, special model numbers may be assigned to fix or establish key specifications for your application on your request. Please consult with your OMRON representative at any time to confirm actual specifications of purchased products.

### DIMENSIONS AND WEIGHTS

Dimensions and weights are nominal and are not to be used for manufacturing purposes, even when tolerances are shown.

### PERFORMANCE DATA

Performance data given in this catalog is provided as a guide for the user in determining suitability and does not constitute a warranty. It may represent the result of OMRON's test conditions, and the users must correlate it to actual application requirements. Actual performance is subject to the OMRON Warranty and Limitations of Liability.

### ERRORS AND OMISSIONS

The information in this document has been carefully checked and is believed to be accurate; however, no responsibility is assumed for clerical, typographical, or proofreading errors, or omissions.

2008.11

In the interest of product improvement, specifications are subject to change without notice.

**OMRON Corporation**  
Industrial Automation Company

<http://www.ia.omron.com/>

(c)Copyright OMRON Corporation 2008 All Right Reserved.

## X-ON Electronics

Largest Supplier of Electrical and Electronic Components

*Click to view similar products for [Industrial Pressure Sensors](#) category:*

*Click to view products by [Omron](#) manufacturer:*

Other Similar products are found below :

[75380-05](#) [76053-00000300-01](#) [76053-00000300-05](#) [76061-00000015-01](#) [76062-B00000350-01](#) [76063-00000350-05](#) [76083-05000500-01](#)  
[76311-05](#) [76577-00000070-01](#) [76584-M00000100-24](#) [77343-24.0H2-01](#) [77343-25.0H2-01](#) [78291-B00000060-01](#) [78303-B00000400-01](#)  
[78303-B00000400-05](#) [78316-B00000030-01](#) [78353-B00000020-05](#) [78665-00000014-05](#) [78677-B00000070-05](#) [78678-00000040-01](#) [79279-](#)  
[00000060-01](#) [79296-B00000350-01](#) [79322-00250035-01](#) [79614-30.0H2-14](#) [79670-00000090-15](#) [79700-00002750-01](#) [79917-B00000280-01](#)  
[80569-00700100-01](#) [81509081](#) [81739-B00000900-01](#) [81807-B00000020-01](#) [MLH010BST01A](#) [MLH010BST14A](#) [MLH025BGC13B](#)  
[MLH025BSCDJ1292](#) [MLH025BSCDJ1303](#) [MLH750PSCDJ1245](#) [82903-B00000020-01](#) [83250-02500600-05](#) [83271-00000040-04](#) [83278-](#)  
[B00000200-21](#) [83286-00000150-01](#) [83299-00000150-05](#) [83303-00000600-01](#) [83305-00001350-01](#) [83330-00000100-01](#) [83349-00001470-24](#)  
[83350-04.0HG-05](#) [83350-15.0H2-05](#) [83357-00000030-21](#)