

A Wide Slot Width of 13 mm and Superior Resistance to Light Interference and Noise.



- Noise resistance equivalent to photomicrosensors with built-in amplifiers.
- Resistance to common noise at least 30 times that of previous models.
- Resistance to inverter noise at least 10 times that of previous models.
- Reverse polarity protection built in.





For the most recent information on models that have been certified for safety standards, refer to your OMRON website.

 Be sure to read *Safety Precautions* on page 3.

Ordering Information

Sensors

 Infrared light

Appearance	Sensing method	Sensing distance (slot width)		Output type	Output configuration	Model
	Through-beam type (with slot)			NPN output	Dark-ON	EE-SPX303N
		13 mm (slot width)			Light-ON	EE-SPX403N

Accessories (Order Separately)

Type	Cable length	Model
Connector		EE-1001
		EE-1009 *
Connector with Cable	1 m	EE-1006 1M
		EE-1010 1M *
	2 m	EE-1006 2M
		EE-1010 2M *
Connector with Robot Cable	1 m	EE-1010-R 1M *
	2 m	EE-1010-R 2M *
NPN/PNP Conversion Connector	0.46 m (total length)	EE-2002

Note: Refer to *Accessories* for details.

* EE-1009- or EE-1010-series Connectors have a builtin locking mechanism to prevent cable disconnection when only the cable is pulled. To remove the Connector from the Sensor, grip the top and bottom of the Connector firmly and push into the Sensor once before pulling out. The locking mechanism prevents the Connector from being removed by pulling on the cable only and enables removal only when the Connector (housing) is pulled.

Ratings and Specifications

Item	Models	EE-SPX303N, EE-SPX403N
Sensing distance		13 mm (slot width)
Sensing object		Opaque: 2.2 × 0.5 mm min.
Differential distance		0.05 mm max.
Light source		Infrared LED (pulse lighting) with a peak wavelength of 940 nm
Indicator		Light indicator (red)
Supply voltage		12 to 24 VDC ±10%, ripple (p-p): 5% max.
Current consumption		15 mA max.
Control output		NPN voltage output: Load power supply voltage: 12 to 24 VDC Load current: 80 mA max. OFF current: 0.5 mA max. 80 mA load current with a residual voltage of 2.0 V max. 10 mA load current with a residual voltage of 1.0 V max.
Protection circuits		Power supply reverse polarity protection, Output reverse polarity protection
Response frequency *		100 Hz min.
Ambient illumination		3,000 lx max. with incandescent light or sunlight on the surface of the receiver.
Ambient temperature range		Operating: -10 to +55°C Storage: -25 to +65°C
Ambient humidity range		Operating: 5% to 85% Storage: 5% to 95%
Vibration resistance		Destruction: 10 to 55 Hz, 1.5-mm double amplitude for 2 h each in X, Y, and Z directions
Shock resistance		Destruction: 500 m/s ² for 3 times each in X, Y, and Z directions
Degree of protection		IEC IP50
Connecting method		Special connector (soldering not possible)
Weight		Approx. 4 g
Material		Polycarbonate

* The response frequency was measured by detecting the following rotating disk.

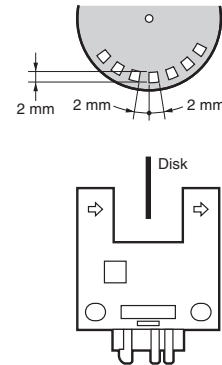

Engineering Data (Reference Value)

Sensing Position Characteristics

EE-SPX303N

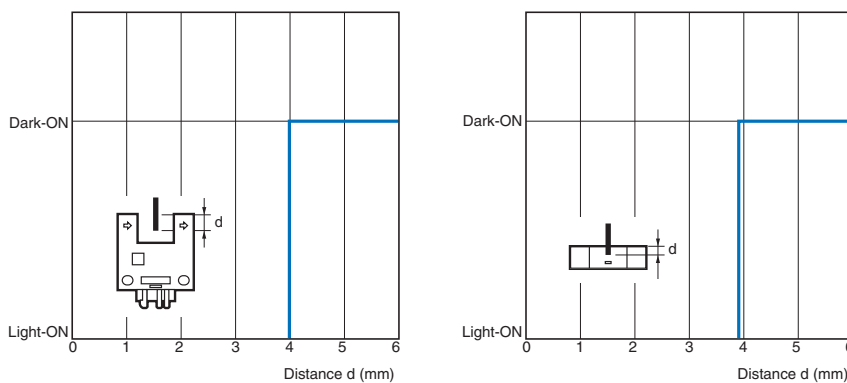

I/O Circuit Diagrams

NPN Output

Model	Output configuration	Timing charts	Output circuit
EE-SPX403N	Light-ON		<p>* Voltage output (when the sensor is connected to a transistor circuit)</p>
EE-SPX303N	Dark-ON		

Safety Precautions

Refer to *Warranty and Limitations of Liability*.

WARNING

This product is not designed or rated for ensuring safety of persons either directly or indirectly. Do not use it for such purposes.

Precautions for Correct Use

Make sure that this product is used within the rated ambient environment conditions.

● **Wiring**

- Connection is made using a connector. Do not solder to the pins (leads). The pins (leads) are soldered to the internal board of the Sensor. Therefore, direct soldering of the pins (leads) may result in an internal disconnection causing malfunction.

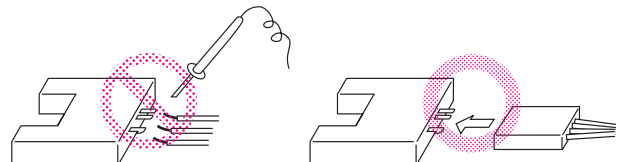

- When extending the cable, use an extension cable with conductors having a total cross-section area of 0.3 mm². The total cable length must be 2 m maximum.
- To use a cable length longer than 2 m, attach a capacitor with a capacitance of approximately 10 μF to the wires as shown below. The distance between the terminal and the capacitor must be within 2 m. (Use a capacitor with a dielectric strength that is at least twice the Sensor's power supply voltage.)

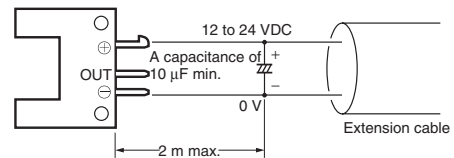

- Make sure the total length of the power cable connected to the product is less than 10 m even if a capacitor is inserted.

(Unit: mm)

Dimensions

Tolerance class IT16 applies to dimensions in this datasheet unless otherwise specified.

Sensors

EE-SPX303N, EE-SPX403N

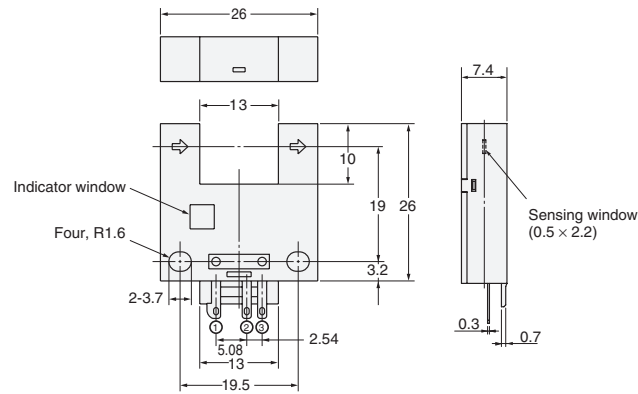

Terminal Arrangement

(1)	+	Vcc
(2)	OUT	OUTPUT
(3)	-	GND (0 V)

Accessories (Order Separately)

* Refer to *Accessories* for details.

Terms and Conditions Agreement

Read and understand this catalog.

Please read and understand this catalog before purchasing the products. Please consult your OMRON representative if you have any questions or comments.

Warranties.

(a) Exclusive Warranty. Omron's exclusive warranty is that the Products will be free from defects in materials and workmanship for a period of twelve months from the date of sale by Omron (or such other period expressed in writing by Omron). Omron disclaims all other warranties, express or implied.

(b) Limitations. OMRON MAKES NO WARRANTY OR REPRESENTATION, EXPRESS OR IMPLIED, ABOUT NON-INFRINGEMENT, MERCHANTABILITY OR FITNESS FOR A PARTICULAR PURPOSE OF THE PRODUCTS. BUYER ACKNOWLEDGES THAT IT ALONE HAS DETERMINED THAT THE PRODUCTS WILL SUITABLY MEET THE REQUIREMENTS OF THEIR INTENDED USE.

Omron further disclaims all warranties and responsibility of any type for claims or expenses based on infringement by the Products or otherwise of any intellectual property right. (c) Buyer Remedy. Omron's sole obligation hereunder shall be, at Omron's election, to (i) replace (in the form originally shipped with Buyer responsible for labor charges for removal or replacement thereof) the non-complying Product, (ii) repair the non-complying Product, or (iii) repay or credit Buyer an amount equal to the purchase price of the non-complying Product; provided that in no event shall Omron be responsible for warranty, repair, indemnity or any other claims or expenses regarding the Products unless Omron's analysis confirms that the Products were properly handled, stored, installed and maintained and not subject to contamination, abuse, misuse or inappropriate modification. Return of any Products by Buyer must be approved in writing by Omron before shipment. Omron Companies shall not be liable for the suitability or unsuitability or the results from the use of Products in combination with any electrical or electronic components, circuits, system assemblies or any other materials or substances or environments. Any advice, recommendations or information given orally or in writing, are not to be construed as an amendment or addition to the above warranty.

See <http://www.omron.com/global/> or contact your Omron representative for published information.

Limitation on Liability; Etc.

OMRON COMPANIES SHALL NOT BE LIABLE FOR SPECIAL, INDIRECT, INCIDENTAL, OR CONSEQUENTIAL DAMAGES, LOSS OF PROFITS OR PRODUCTION OR COMMERCIAL LOSS IN ANY WAY CONNECTED WITH THE PRODUCTS, WHETHER SUCH CLAIM IS BASED IN CONTRACT, WARRANTY, NEGLIGENCE OR STRICT LIABILITY.

Further, in no event shall liability of Omron Companies exceed the individual price of the Product on which liability is asserted.

Suitability of Use.

Omron Companies shall not be responsible for conformity with any standards, codes or regulations which apply to the combination of the Product in the Buyer's application or use of the Product. At Buyer's request, Omron will provide applicable third party certification documents identifying ratings and limitations of use which apply to the Product. This information by itself is not sufficient for a complete determination of the suitability of the Product in combination with the end product, machine, system, or other application or use. Buyer shall be solely responsible for determining appropriateness of the particular Product with respect to Buyer's application, product or system. Buyer shall take application responsibility in all cases.

NEVER USE THE PRODUCT FOR AN APPLICATION INVOLVING SERIOUS RISK TO LIFE OR PROPERTY OR IN LARGE QUANTITIES WITHOUT ENSURING THAT THE SYSTEM AS A WHOLE HAS BEEN DESIGNED TO ADDRESS THE RISKS, AND THAT THE OMRON PRODUCT(S) IS PROPERLY RATED AND INSTALLED FOR THE INTENDED USE WITHIN THE OVERALL EQUIPMENT OR SYSTEM.

Programmable Products.

Omron Companies shall not be responsible for the user's programming of a programmable Product, or any consequence thereof.

Performance Data.

Data presented in Omron Company websites, catalogs and other materials is provided as a guide for the user in determining suitability and does not constitute a warranty. It may represent the result of Omron's test conditions, and the user must correlate it to actual application requirements. Actual performance is subject to the Omron's Warranty and Limitations of Liability.

Change in Specifications.

Product specifications and accessories may be changed at any time based on improvements and other reasons. It is our practice to change part numbers when published ratings or features are changed, or when significant construction changes are made. However, some specifications of the Product may be changed without any notice. When in doubt, special part numbers may be assigned to fix or establish key specifications for your application. Please consult with your Omron's representative at any time to confirm actual specifications of purchased Product.

Errors and Omissions.

Information presented by Omron Companies has been checked and is believed to be accurate; however, no responsibility is assumed for clerical, typographical or proofreading errors or omissions.

2017.12

In the interest of product improvement, specifications are subject to change without notice.

OMRON Corporation
Industrial Automation Company

<http://www.ia.omron.com/>

(c)Copyright OMRON Corporation 2017 All Right Reserved.

X-ON Electronics

Largest Supplier of Electrical and Electronic Components

Click to view similar products for [Sensor Fixings & Accessories](#) category:

Click to view products by [Omron](#) manufacturer:

Other Similar products are found below :

[F03-01 SUS304 BINIL](#) [8000-5130](#) [FH-AP1](#) [PH-1-10M](#) [PH-1-20M](#) [PH-2-30M](#) [AC201](#) [R4](#) [ADI-LC3S](#) [EC18-WELL](#) [PC-15015](#) [K35-4](#) [A-1923](#) [SS-12143](#) [STA12](#) [AP4-T](#) [PH-1-50M](#) [R6](#) [D01051301](#) [43912557-020](#) [MF-1 D=3.2](#) [BGN-035](#) [E39-L7](#) [ZX-SB11](#) [D01070602](#) [606072](#) [606075](#) [Y92ES12PVC4A10ML](#) [Y92ES12PVC4S5ML](#) [SA9Z-F11](#) [Z49-SF1](#) [ZFV-XMF2](#) [E4R-R12A-CS3M010](#) [28810-2](#) [ZX-SW11E V3](#) [CCS-PL-LDR2-70](#) [E4R-R12A-CS3M020](#) [BS-1T CHITAN](#) [F03-01 CHITAN](#) [CCS-PD2-1012](#) [PH-2-90M](#) [PH-2-5M](#) [XMLZL008](#) [AC244](#) [28810-1](#) [PH-1-40M](#) [SS-12225](#) [32043-500](#) [81532111](#) [PH-2-60M](#)