

## Photomicrosensor (Transmissive) EE-SH3 Series

**⚠ Be sure to read *Precautions* on page 25.**

### ■ Dimensions

**Note:** All units are in millimeters unless otherwise indicated.

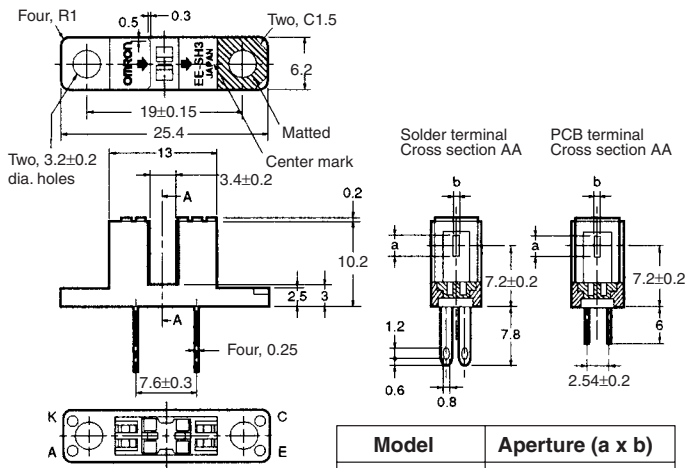

### Internal Circuit

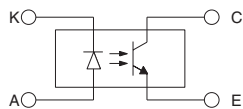

Unless otherwise specified, the tolerances are as shown below.

Dimensions	Tolerance
3 mm max.	±0.2
3 < mm ≤ 6	±0.24
6 < mm ≤ 10	±0.29
10 < mm ≤ 18	±0.35
18 < mm ≤ 30	±0.42

Terminal No.	Name
A	Anode
K	Cathode
C	Collector
E	Emitter

### ■ Features

- High-resolution model with a 0.2-mm-wide or 0.5-mm-wide sensing aperture, high-sensitivity model with a 1-mm-wide sensing aperture, and model with a horizontal sensing aperture are available.
- Solder terminal models:  
EE-SH3/-SH3-CS/-SH3-DS/-SH3-GS
- PCB terminal models:  
EE-SH3-B/-SH3-C/-SH3-D/-SH3-G

### ■ Absolute Maximum Ratings (Ta = 25°C)

Item	Symbol	Rated value
Emitter	Forward current	$I_F$ 50 mA (see note 1)
	Pulse forward current	$I_{FP}$ 1 A (see note 2)
	Reverse voltage	$V_R$ 4 V
Detector	Collector–Emitter voltage	$V_{CEO}$ 30 V
	Emitter–Collector voltage	$V_{ECO}$ ---
	Collector current	$I_C$ 20 mA
	Collector dissipation	$P_C$ 100 mW (see note 1)
Ambient temperature	Operating	$T_{opr}$ -25°C to 85°C
	Storage	$T_{stg}$ -30°C to 100°C
Soldering temperature	$T_{sol}$	260°C (see note 3)

- Note:**
1. Refer to the temperature rating chart if the ambient temperature exceeds 25°C.
  2. The pulse width is 10 μs maximum with a frequency of 100 Hz.
  3. Complete soldering within 10 seconds.

### ■ Electrical and Optical Characteristics (Ta = 25°C)

Item	Symbol	Value				Condition	
		EE-SH3(-B)	EE-SH3-C(S)	EE-SH3-D(S)	EE-SH3-G(S)		
Emitter	Forward voltage	$V_F$	1.2 V typ., 1.5 V max.			$I_F = 30$ mA	
	Reverse current	$I_R$	0.01 μA typ., 10 μA max.			$V_R = 4$ V	
	Peak emission wavelength	$\lambda_p$	940 nm typ.			$I_F = 20$ mA	
Detector	Light current	$I_L$	0.5 to 14 mA typ.	1 to 28 mA typ.	0.1 mA min.	0.5 to 14 mA	$I_F = 20$ mA, $V_{CE} = 10$ V
	Dark current	$I_D$	2 nA typ., 200 nA max.			$V_{CE} = 10$ V, 0 lx	
	Leakage current	$I_{LEAK}$	---			---	
	Collector–Emitter saturated voltage	$V_{CE} (sat)$	0.1 V typ., 0.4 V max.		---	0.1 V typ., 0.4 V max.	$I_F = 20$ mA, $I_L = 0.1$ mA
	Peak spectral sensitivity wavelength	$\lambda_p$	850 nm typ.			$V_{CE} = 10$ V	
Rising time	$t_r$	4 μs typ.				$V_{CC} = 5$ V, $R_L = 100$ Ω, $I_L = 5$ mA	
Falling time	$t_f$	4 μs typ.					

Engineering Data

Forward Current vs. Collector Dissipation Temperature Rating

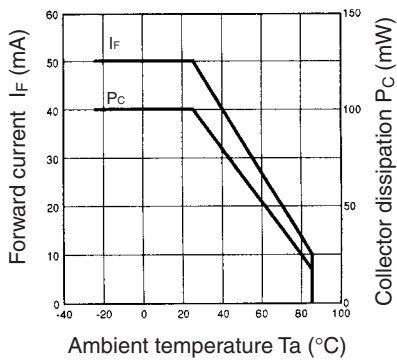

Forward Current vs. Forward Voltage Characteristics (Typical)

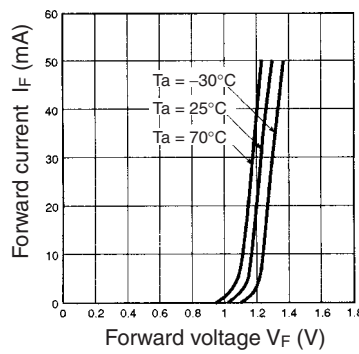

Light Current vs. Forward Current Characteristics (Typical)

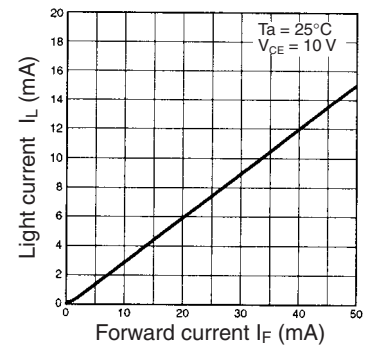

Light Current vs. Collector-Emitter Voltage Characteristics (EE-SH3(-B))

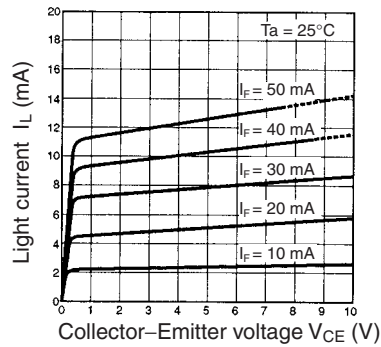

Relative Light Current vs. Ambient Temperature Characteristics (Typical)

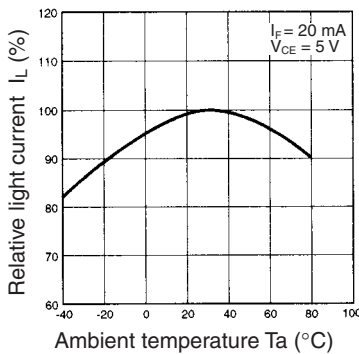

Dark Current vs. Ambient Temperature Characteristics (Typical)

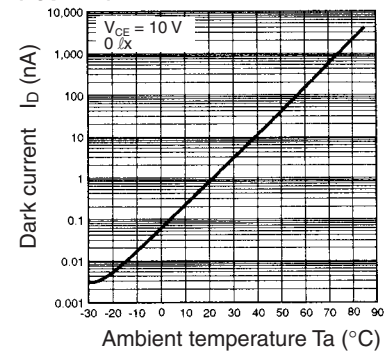

Response Time vs. Load Resistance Characteristics (Typical)

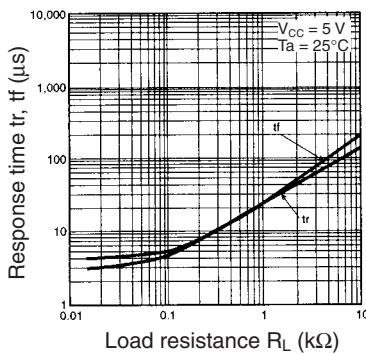

Sensing Position Characteristics (EE-SH3-D(S))

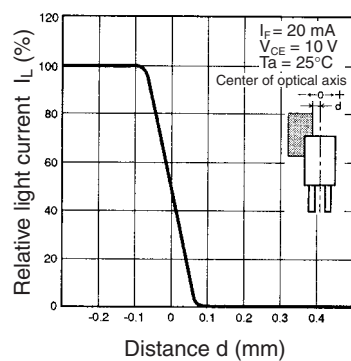

Sensing Position Characteristics (EE-SH3(-B))

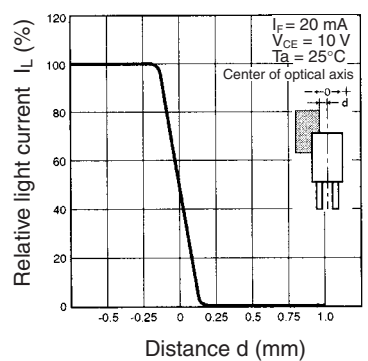

Sensing Position Characteristics (EE-SH3-G(S))

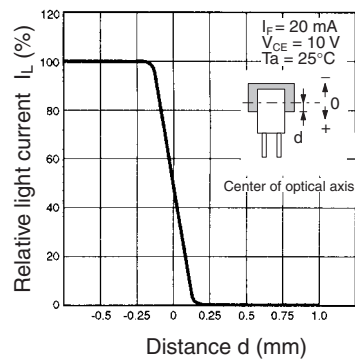

Sensing Position Characteristics (EE-SH3-C(S))

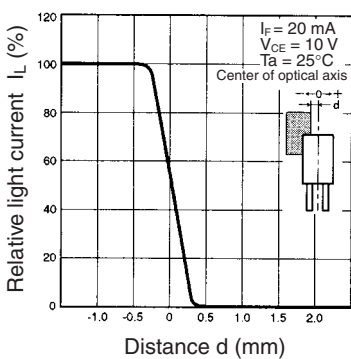

Response Time Measurement Circuit

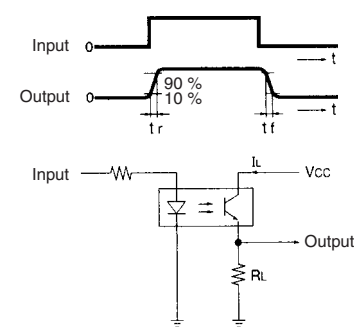

## X-ON Electronics

Largest Supplier of Electrical and Electronic Components

*Click to view similar products for [Optical Switches](#), [Transmissive](#), [Phototransistor Output](#) category:*

*Click to view products by [Omron](#) manufacturer:*

Other Similar products are found below :

[LTH-301-07](#) [LTH-301-23](#) [E3C-X2C](#) [E3S-LS20B4S1](#) [E3SX2CE4](#) [RPI-0125B](#) [RPI-2501](#) [RPI-576A](#) [KRA021](#) [LTH-306-04M](#) [LTH-309-08](#)  
[HOA0865-100](#) [HOA1961-055](#) [E3F-3C4](#) [LTH-306-01](#) [RPI-574](#) [EESX677C1JR01M](#) [SIT506F-A](#) [HOA1883-501](#) [PT928-6B-F](#) [RPI-243](#) [EE-](#)  
[SX675P-WR 1M](#) [OPB806](#) [EE-SX1128](#) [OPB857Z](#) [EE-SV3-B](#) [EE-SJ3-D](#) [RPI-0226](#) [EE-SX951P-W 1M](#) [EE-SX672R](#) [EE-SX670P-WR 1M](#)  
[LTH-301-32](#) [EESX674PWR1M](#) [EE-SX952-W 1M](#) [RPI-0352E](#) [RPI-352C40N](#) [DY-ITR002](#) [DY-ITR1100](#) [DY-ITR9909-W2](#) [HOA0825-001](#)  
[HOA0825-003](#) [HOA0860-N51](#) [HOA0861-N55](#) [HOA0861-P55](#) [HOA0861-T55](#) [HOA0866-P55](#) [HOA0866-T55](#) [HOA0867-P55](#) [HOA0867-](#)  
[T55](#) [HOA0870-T51](#)