

Engineering Data

Forward Current vs. Collector Dissipation Temperature Rating

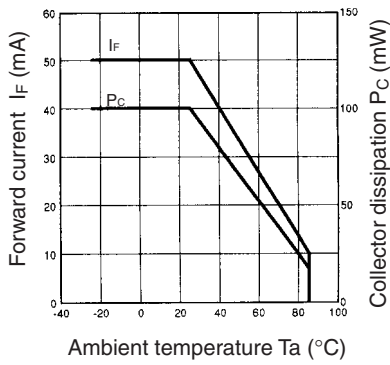

Forward Current vs. Forward Voltage Characteristics (Typical)

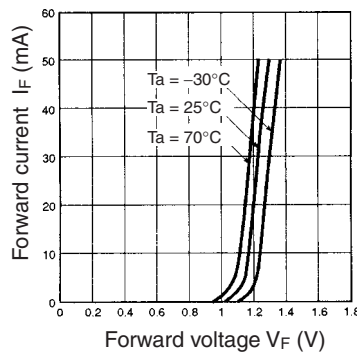

Light Current vs. Forward Current Characteristics (Typical)

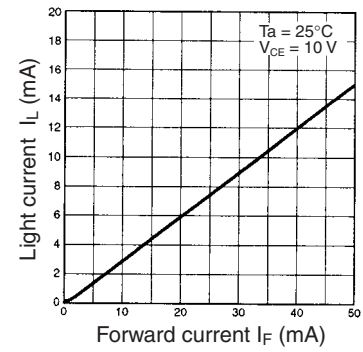

Light Current vs. Collector-Emitter Voltage Characteristics (EE-SV3(-B))

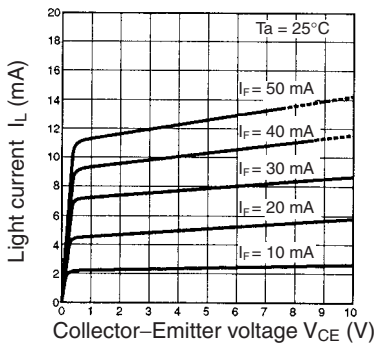

Relative Light Current vs. Ambient Temperature Characteristics (Typical)

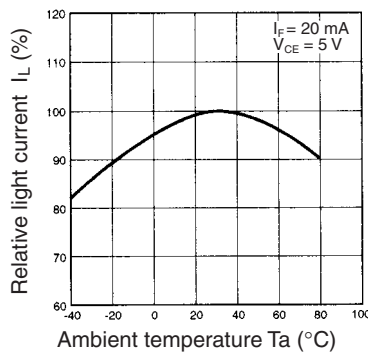

Dark Current vs. Ambient Temperature Characteristics (Typical)

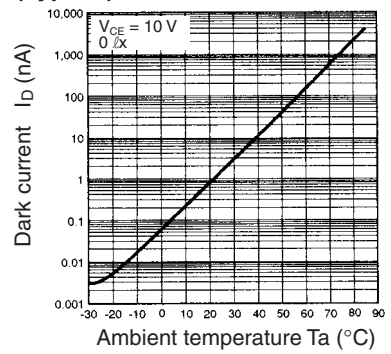

Response Time vs. Load Resistance Characteristics (Typical)

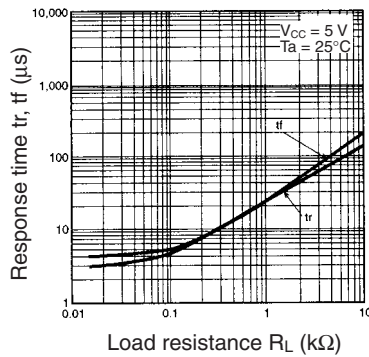

Sensing Position Characteristics (EE-SV3-D(S))

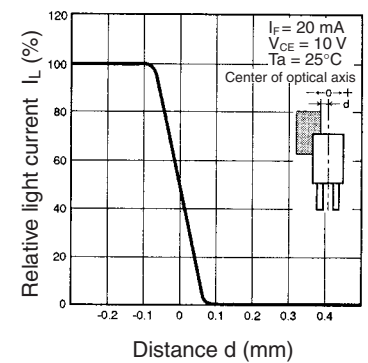

Sensing Position Characteristics (EE-SV3(-B))

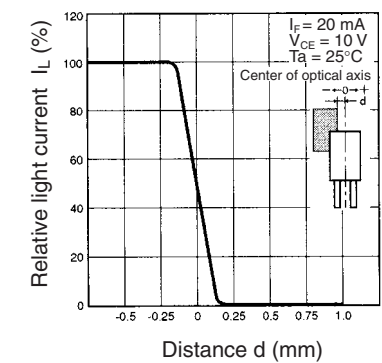

Sensing Position Characteristics (EE-SV3-G(S))

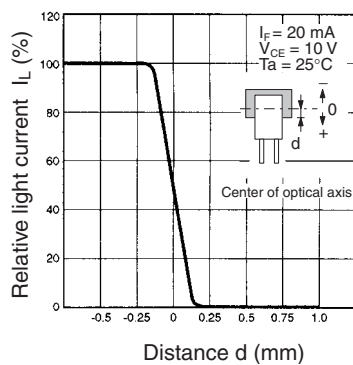

Sensing Position Characteristics (EE-SV3-C(S))

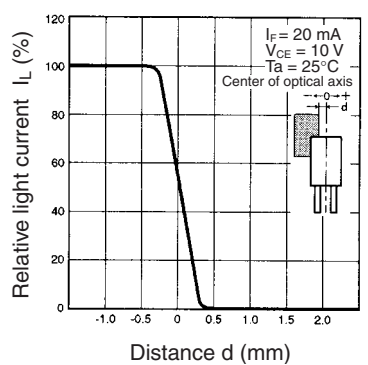

Response Time Measurement Circuit

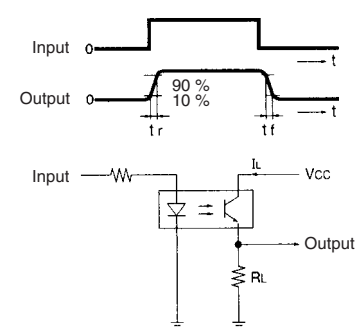

X-ON Electronics

Largest Supplier of Electrical and Electronic Components

Click to view similar products for [Omron](#) manufacturer:

Other Similar products are found below :

[G9ED-1-B-AQ-DC24](#) [E3X-SD11 2M](#) [S8VM-10024C](#) [R88A-CCW002P2](#) [S82Y-VM30D](#) [H3AM-NS-A AC100-240](#) [G3NA-440B-2 DC5-24](#)
[XF2J-0824-11A-R100](#) [G3NA-425B-2 DC5-24](#) [MY2N-DC24](#) [XF2J-0824-12A](#) [G8JN-1C7T-R-DC12](#) [G8VA-1A4T-R01-DC12](#) [G8HE-1A7T-](#)
[R-DC12](#) [XF2W-2415-1A](#) [XF2U-3015-3A](#) [G8V-RH-1A7T-R-DC12](#) [LY1D-2-5S-AC120](#) [M165-JR-24D](#) [M16-TG-24D](#) [CS1G-CPU43-E](#)
[M22CAT1](#) [61F-GP-NT AC110](#) [M7E-01DGN2-B](#) [M7E-02DGN2](#) [M7E-08DRN2](#) [M7E-20DRN1](#) [M7E-HRN2](#) [M8PHWS](#) [D2HW-BL211DL](#)
[D2VW-5L2A-2MS](#) [F03-02 SUS316](#) [F150LTC20](#) [F3SJ-A0245P30](#) [F3STGRNSMC21M1J8](#) [F3UVHM](#) [MG2-US-AC24](#) [MGN1C-DC24](#)
[MK2EP-UA-AC6V](#) [MK2PNIAC240](#) [MK310E-DC24](#) [MKS2XTIN-11 DC110](#) [MM4KPAC120NC](#) [MM4XPAC120](#) [G2Q-184P-V-DC5](#) [G2R-](#)
[1114P-V-US-DC5](#) [G2R13SNDDC24](#) [G2R-1-T 5VDC](#) [G2R-2 240VAC](#) [G2R-2 48VAC](#)