

Photomicrosensor (Reflective) EE-SY1200

⚠ Be sure to read Precautions on page 24.

■ Dimensions

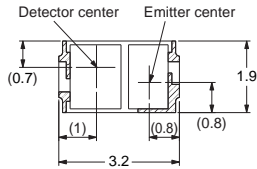

Note:
Unless otherwise specified tolerances are ± 0.15 .
No burrs dimensions are included in outline dimensions.
The burrs dimensions are 0.15 MAX.
Diagonal line indicate the region is part Au plating area.

Recommended Soldering Pattern

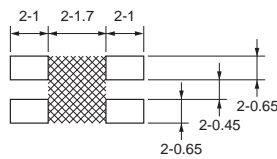

Note:1. The shaded portion in the above figure may cause shorting. Do not wire in this portion.
2. The dimensional tolerance for the recommended soldering pattern is ± 0.1 mm.

Internal Circuit

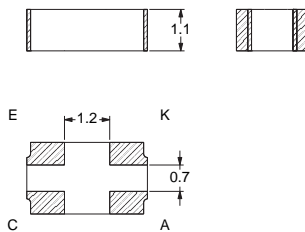
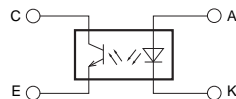

Terminal No.	Name
A	Anode
K	Cathode
C	Collector
E	Emitter

■ Features

- Ultra-compact model.
- PCB surface mounting type.
- High S/N ratio (High light current / Low leakage current)
- Recommended sensing distance = 1.0 to 4.0 mm

■ Absolute Maximum Ratings (Ta=25°C)

Item	Symbol	Rated value	Unit
Emitter	Forward current	I_F	50^{*1} mA
	Pulse forward current	I_{FP}	500^{*2} mA
	Reverse voltage	V_R	4 V
Detector	Collector-Emitter voltage	V_{CE0}	30 V
	Emitter-Collector voltage	V_{ECO}	5 V
	Collector current	I_C	20 mA
	Collector dissipation	P_C	50^{*1} mW
Operating temperature	T_{opr}	-25 to +85	°C
Storage temperature	T_{stg}	-40 to +100	°C
Reflow soldering temperature	T_{sol}	240^{*3}	°C

*1 Refer to the temperature rating chart if the ambient temperature exceeds 25°C.

*2 The pulse width is 10 μ s maximum with a frequency of 100 Hz.

*3 Complete soldering within 10 seconds for reflow soldering.

■ Electrical and Optical Characteristics (Ta=25°C)

Item	Symbol	Value			Unit	Condition	
		MIN.	TYP.	MAX.			
Emitter	Forward voltage	V_F	---	1.2	1.4	V	$I_F = 20$ mA
	Reverse current	I_R	---	---	10	μ A	$V_R = 4$ V
	Peak emission wavelength	λ_p	---	940	---	nm	---
Detector	Light current 1	I_{L1}	200	---	1000	μ A	$I_F = 10$ mA, $V_{CE} = 2$ V, Aluminum-deposited surface, $d = 4$ mm ^{*1}
	Light current 2	I_{L2}	150	---	---	μ A	$I_F = 4$ mA, $V_{CE} = 2$ V, Aluminum-deposited surface, $d = 1$ mm ^{*1}
	Dark current	I_D	---	2	200	nA	$V_{CE} = 10$ V, 0 lx
	Leakage current 1	I_{LEAK1}	---	---	500	nA	$I_F = 10$ mA, $V_{CE} = 2$ V, with no reflection ^{*2}
	Leakage current 2	I_{LEAK2}	---	---	200	nA	$I_F = 4$ mA, $V_{CE} = 2$ V, with no reflection ^{*2}
	Collector-Emitter saturated voltage	$V_{CE}(\text{sat})$	---	---	---	V	---
	Peak spectral sensitivity wavelength	λ_p	---	850	---	nm	---
Rising time	t_r	---	30	---	μ s	$V_{CC} = 2$ V, $R_L = 1$ k Ω , $I_L = 100$ μ A, $d = 1$ mm ^{*1}	
Falling time	t_f	---	30	---	μ s	$V_{CC} = 2$ V, $R_L = 1$ k Ω , $I_L = 100$ μ A, $d = 1$ mm ^{*1}	

*1. The letter "d" indicates the distance between the top surface of the sensor and the sensing object.

*2. Depends on the installed condition of the Photomicrosensor, the detector may receive the sensor's LED light and/or the external light which is reflected from surroundings of the Photomicrosensor and/or the background object.

Please confirm the condition of the Photomicrosensor by actual intended application prior to the mass production use.

Engineering Data

Forward Current vs. Collector Dissipation Temperature Rating

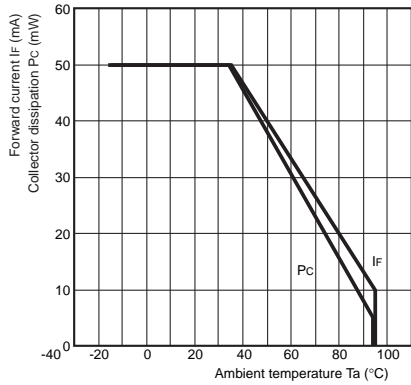

Forward Current vs. Forward Voltage Characteristics (Typical)

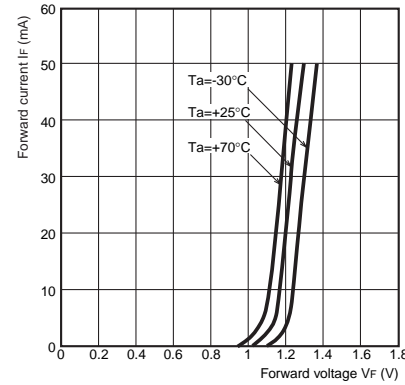

Light Current vs. Forward Current Characteristics (Typical)

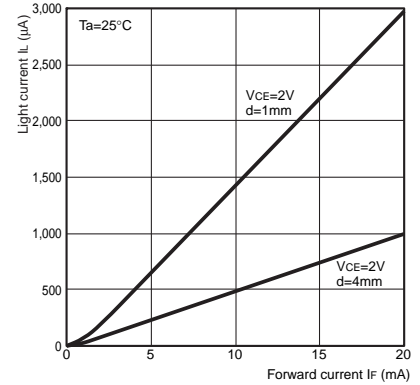

Light Current vs. Collector-Emitter Voltage Characteristics (Typical)

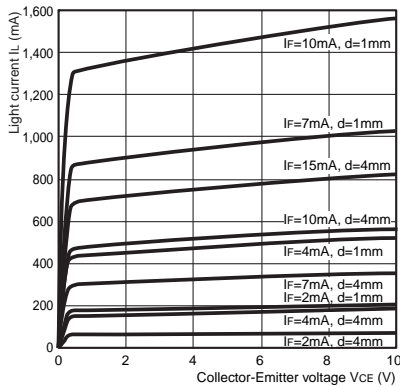

Relative Light Current vs. Ambient Temperature Characteristics (Typical)

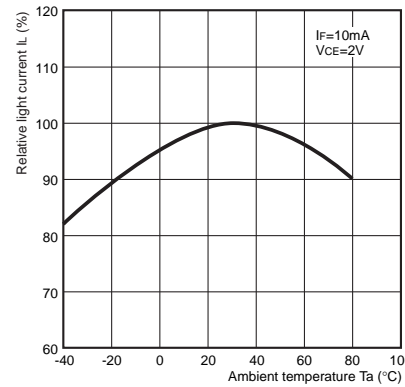

Dark Current vs. Ambient Temperature Characteristics (Typical)

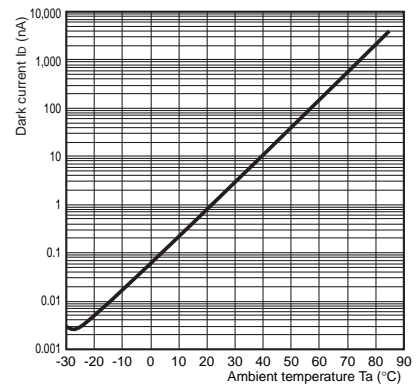

Response Time vs. Load Resistance Characteristics (Typical)

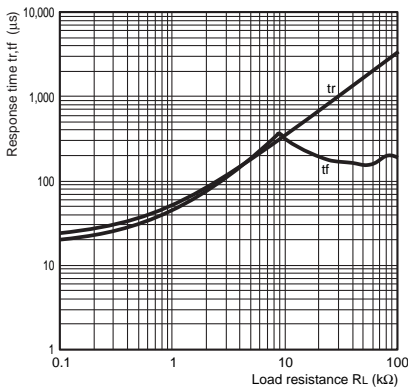

Sensing Distance Characteristics (Typical)

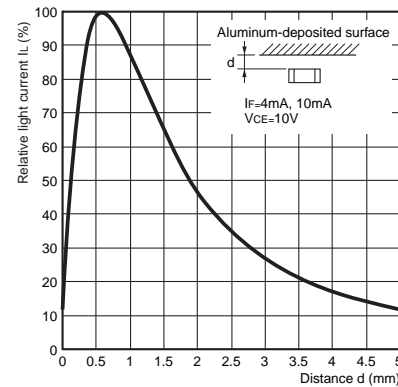

Sensing Position Characteristics (Typical)

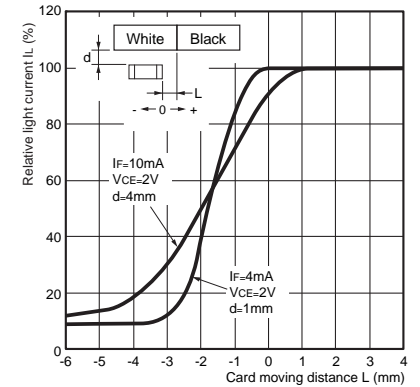

Sensing Position Characteristics (Typical)

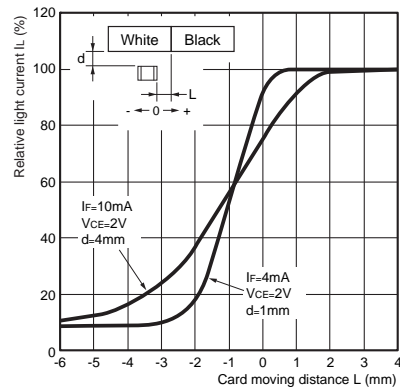

Response Time Measurement Circuit

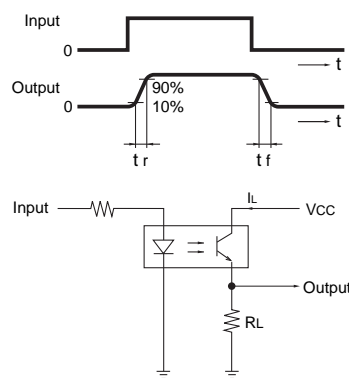

Light Current Measurement Setup Diagram

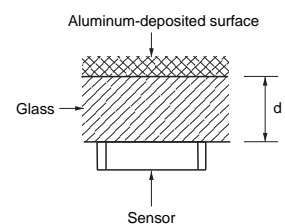

■ Tape and Reel

Reel Dimension (Unit: mm)

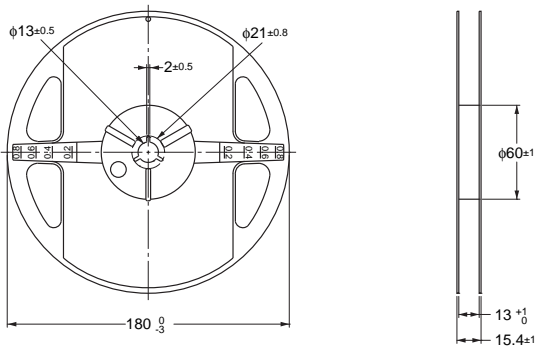

Tape Dimension (Unit: mm)

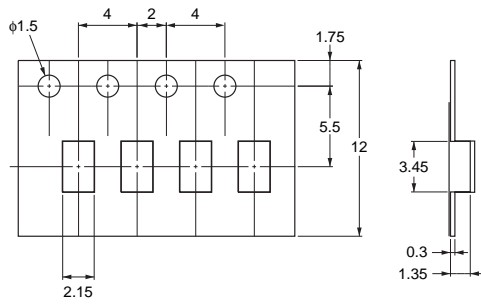

Part Mounting Direction

- The devices are oriented in the rectangular holes in the carrier tape so that the edge with the LED faces the round feeding holes.

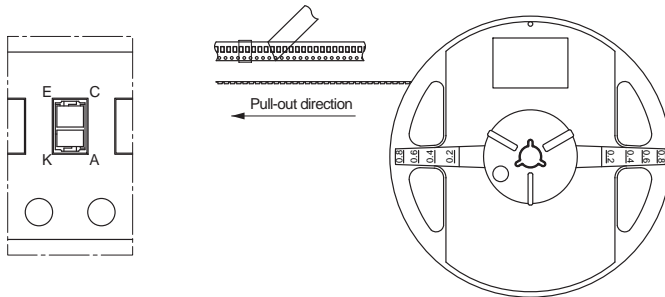

Tape Quantity

2,000 pcs./reel

■ Precautions to be taken on mounting

Temperature Profile

The reflow soldering can be implemented in two times complying with the following diagram.

All the temperatures in the product must be within the diagram.

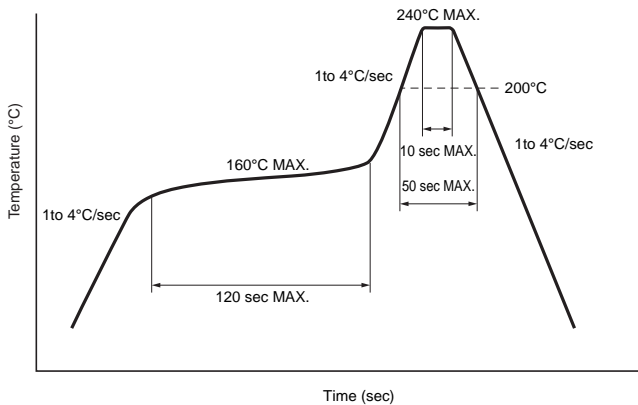

Treatment after Opening

1. Reflow soldering must be done within 48 hours stored at the conditions of humidity 60%RH or less and temperature 5 to 25°C.
2. In case of long time storage after open, please mount at the conditions of humidity 70%RH or less and temperature 5 to 30°C within 1 week by using dry box or resealing with desiccant in moisture-proof bag by sealer.

Baking before Mounting

In case that it could not carry out the above treatment, it is able to mount by baking treatment.

However baking treatment shall be limited only 1 time.

- Recommended conditions :
- 60°C, 12 to 24 hours (reeled one)
 - 100°C, 8 to 24 hours (loose one)

Manual soldering

The manual soldering cannot be applied to the products.

There is a possibility that the housing is deformed and/or Au plating is peeled off by heat.

Other Notes

The use of infrared lamp causes the temperature at the resin to rise particularly too high.

All the temperatures in the product must be within the above diagram.

Do not immerse the resin part into the solder.

Even if within the above temperature diagram, there is a possibility that the gold wire in the products is broken in case that the deformation of PCB gives the stress to the product terminals.

Please confirm the conditions of the reflow soldering fully by actual solder reflow machine prior to the mass production use.

■ Storage and Handling after Opening

Storage Conditions

In order to avoid the absorption of moisture, the products shall be stored in a dry box with desiccant or in the following conditions.

Storage temp. : 5 to 30°C

Storage humidity : 70%RH or less

X-ON Electronics

Largest Supplier of Electrical and Electronic Components

Click to view similar products for [Optical Switches, Reflective, Phototransistor Output](#) category:

Click to view products by [Omron](#) manufacturer:

Other Similar products are found below :

[LTH-1650-01](#) [HOA1180-106](#) [NJL5303R-TE1](#) [ITR8307/L24/TR8](#) [RPR-359F](#) [OPR5005](#) [EE-SF5-B](#) [QRD1114](#) [ITR8307](#) [ITR-20001T](#) [ITR-20002](#) [ITR-8307/TR8](#) [ITR9606-F](#) [HOA0708-001](#) [HOA0709-001](#) [HOA0709-011](#) [HOA1180-001](#) [HOA1180-002](#) [HOA1397-001](#) [HOA1406-003](#) [HOA2498-002](#) [LTH-209-01](#) [NJL5501R-TE1](#) [NJL5902R-2-TE1](#) [EE-SB5](#) [EE-SB5-B](#) [EE-SF5](#) [EE-SPY302](#) [EE-SPY311](#) [EE-SPY312](#) [EE-SPY401](#) [EE-SPY402](#) [EE-SPY411](#) [EE-SPY412](#) [EE-SPZ301A](#) [EE-SPZ401A](#) [EESB5MW12](#) [EE-SY110](#) [EE-SY113](#) [EE-SY169](#) [EE-SY169A](#) [EE-SY171](#) [EE-SY190](#) [EE-SY199](#) [EE-SY671](#) [EE-SY672](#) [QRD1113](#) [QRE1113](#) [QRE1113GR](#) [SFH 9206](#)