

Infrared Thermosensor ES1B

Achieve Low-cost Measurements with an Infrared Thermosensor.

- The ES1B has an electromotive output as high as that of a thermocouple, thus connecting directly to the thermocouple input terminal of the Temperature Controller is possible.
- Four temperature ranges are available to cover a wide range of temperature measurement needs, including those in the food processing, packaging, molding, and electronics industries.
- High-accuracy temperature measurement is ensured by a high-speed response of 300 ms (for a 63% response) and an indication reproducibility of $\pm 1\%$ PV.
- Unlike thermocouples, the Thermosensor does not deteriorate. Therefore, stable, real-time temperature control can be maintained.



NEW

Ordering Information

List of Models

Appearance and sensing characteristic	Specification (temperature range)	Model
	10 to 70°C	ES1B
	60 to 120°C	
	115 to 165°C	
	140 to 260°C	

Application Examples

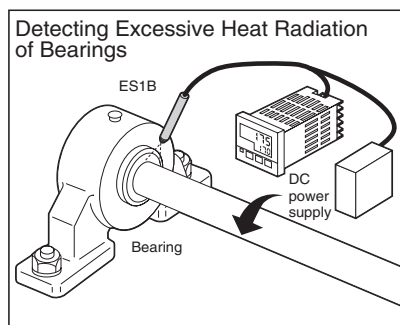
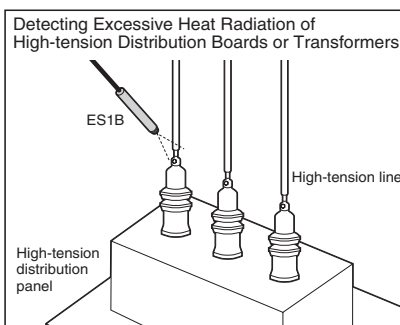
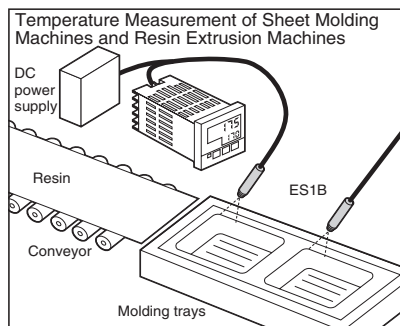
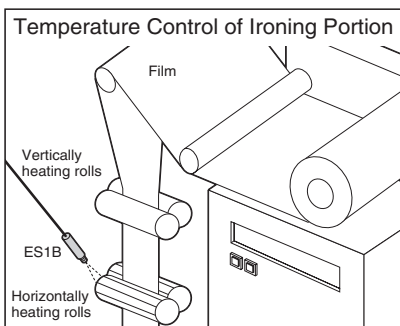

- Note:**
1. Either a 12 VDC or 24 VDC power supply is required for the ES1B.
 2. The ES1B cannot be used with OMRON's E5ZE Multipoint Temperature Controller. (It can be used with the E5ZN, E5AR, and E5ER.)

Specifications

■ Ratings/Characteristics

Item		ES1B
Power supply voltage		12/24 VDC
Operating voltage range		90% to 110% of the power supply voltage
Current consumption		20 mA max.
Measuring temperature range		10 to 70°C, 60 to 120°C, 115 to 165°C, 140 to 260°C
Accuracy (See note 1.)	±5°C (See note 2.)	±2% PV or ±2°C, whichever is larger
	±10°C (See note 2.)	±4% PV or ±4°C, whichever is larger
	±30°C (See note 2.)	±6% PV or ±6°C, whichever is larger
	±40°C (See note 2.)	±8% PV or ±8°C, whichever is larger
Reproducibility		±1% PV or ±1°C, whichever is larger
Temperature drift		0.4°C/°C max.
Sensing distance vs. sensing diameter		1:1 typ.
Measurement wavelength		6.5 to 14.0 μm
Receiver element		Thermopile
Response speed		Approximately 300 ms at response rate of 63%
Output impedance		1 to 4 kΩ
Operating temperature		-25°C to 70°C (with no icing or condensation)
Allowable ambient humidity		35% to 85%
Vibration resistance (destruction)		98 m/s ² for 2 hours each in X, Y, and Z directions at 10 to 55 Hz
Shock resistance (destruction)		300 m/s ² for 3 times each in X, Y, and Z directions
Casing material		ABS resin
Degree of protection		IP65
Weight		Approx. 120 g
Cable		Compensating conductor: 3 m PVC-covered cable with a shield wire resisting 70°C

Note: 1. Based on characteristics of K-type thermocouple and radiation rate of 0.9.

2. The accuracy is given as the change in temperature from any reference temperature of the sensing object. For example, if the reference temperature is 50°C, the accuracy at 55°C would be ±2% PV or ±2°C, whichever is larger and the accuracy at 60°C would be ±4% PV or ±4°C, whichever is larger.

Connections

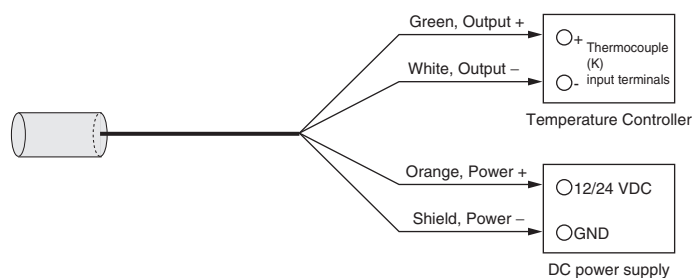

Dimensions

Note: All units are in millimeters unless otherwise indicated.

ES1B

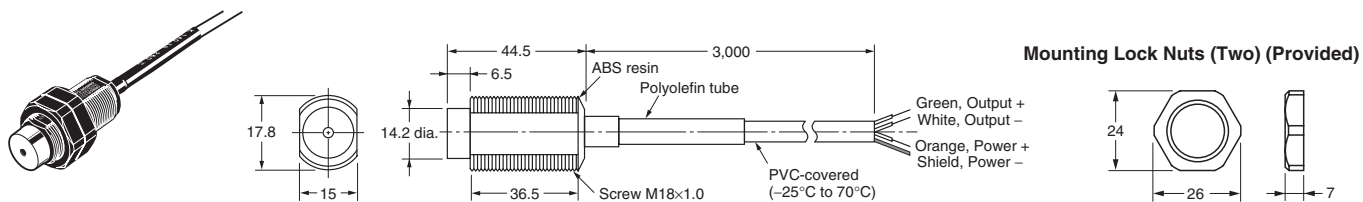

Adjustment Methods

Adjust the Thermosensor as described below before using it.

Adjust the Thermosensor according to the conditions of the sensing object and characteristics of the Temperature Controller.

Offset Compensation for Target Value with Input Shift Function

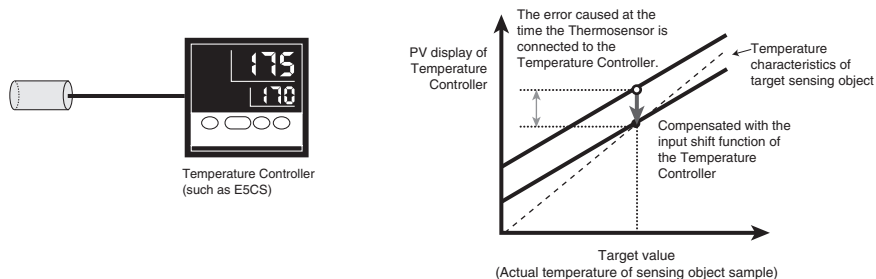

Gain and Offset Compensation with Two-point Shift Function

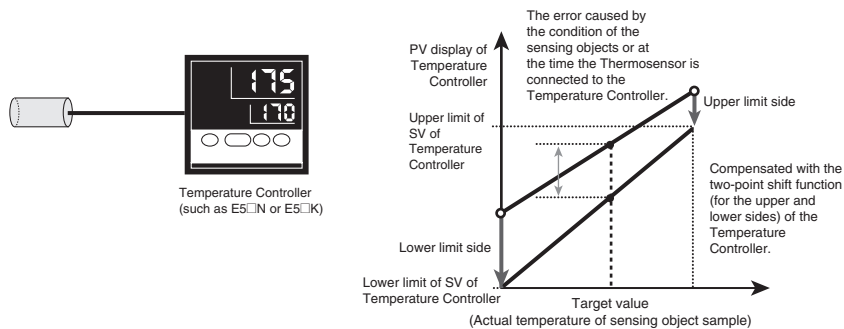

■ One-point Input Shift

Preparations

- Set a temperature input range that is suitable for the input specifications of the Infrared Thermosensor.
- Prepare a thermometer to measure the temperature of the sensing object as shown in figure 1, below.

Configuration for Offsetting the Infrared Thermosensor Input (Figure 1)

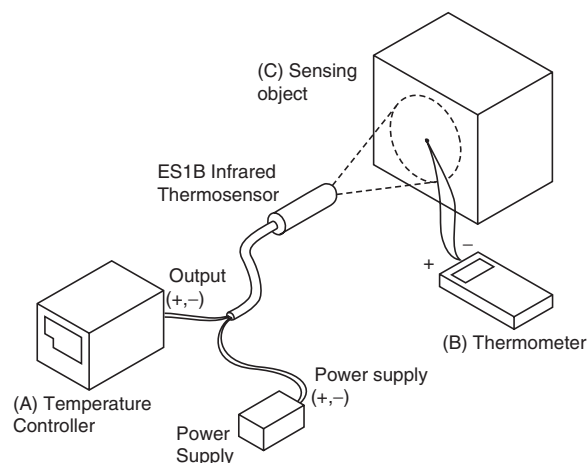

Example for the E5CN

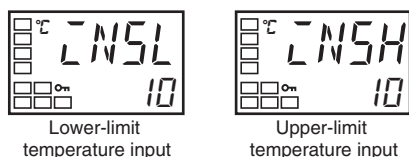

1. Adjust the temperature of the sensing object in the configuration shown in figure 1 to near the set point. We will assume that the temperature indicated on the thermometer is the actual temperature of the sensing object.
2. Check the temperature C of the sensing object and the temperature A indicated on the Controller and set both the upper-limit and lower-limit temperature input settings to the following value:
Temperature C (sensing object) – Temperature A (Controller)
3. Check the temperature C of the sensing object and the temperature A indicated on the Controller again. If they are about the same, then setting the offset has been completed.

Diagram of One-point Input Shift

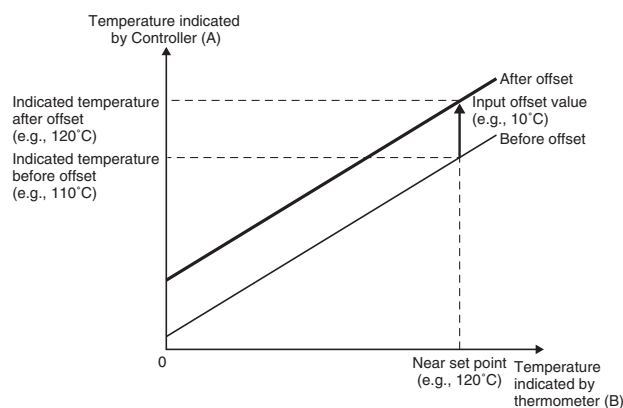

■ Two-point Input Shift

Use a two-point input shift to output more accurate display values than is possible with a 1-point input shift.

Preparations

Refer to the preparations for a one-point input shift.

1. The input value is shifted at two points: near room temperature and near the set point. To do so, first check the temperature C of the sensing object and the temperature A indicated on the Controller at both near room temperature and near the set point.
2. Use the following formulas to calculate the upper-limit temperature input and lower-limit temperature input settings based on the values checked above.

Diagram of Two-point Input Shift

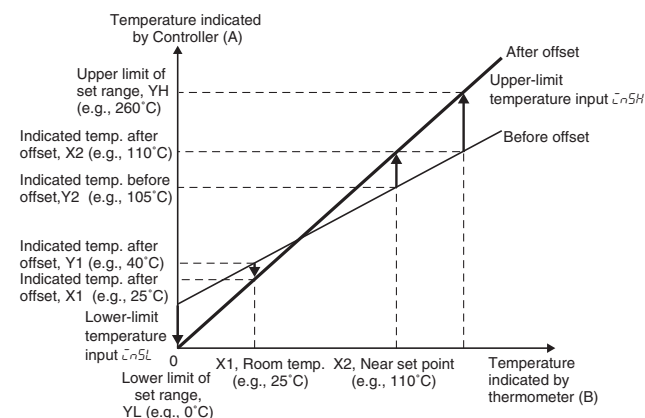

Lower-limit Temperature Input Setting

$$\bar{C}n5L = \frac{Y_L - Y_1}{Y_2 - Y_1} \times \{(X_2 - Y_2) - (X_1 - Y_1)\} + (X_1 - Y_1)$$

Upper-limit Temperature Input Setting

$$\bar{C}n5H = \frac{Y_H - Y_1}{Y_2 - Y_1} \times \{(X_2 - Y_2) - (X_1 - Y_1)\} + (X_1 - Y_1)$$

3. Set both the upper-limit and lower-limit temperature input settings and then check the temperature C of the sensing object and the temperature A indicated on the Controller both near room temperature and near the set point.
4. Although here we have used two points, near room temperature and near the set point, accuracy can be increased even further by using another point within the measurement temperature range other than the set value instead of room temperature.

Example for the E5CN

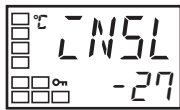

Lower-limit
temperature input

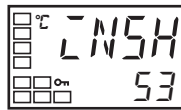

Upper-limit
temperature input

In this example, the ES1B is used between 140 and 260°C. Here, the set point lower limit, YL, would be 0°C and the set point upper limit, YH, would be 260°C in formulas 1 and 2. The temperatures of the sensing object are checked next.

The offset values can be calculated as shown below when the Controller display Y1 is 40°C for a room temperature X1 of 25°C and when the Controller display Y2 is 105°C for a set point temperature X2 of 110°C

Upper-limit Temperature Input Setting

$$\begin{aligned} \bar{LNSH} &= \frac{0-40}{105-40} \times \{(110-105)-(25-40)\} + (25-40) \\ &= -27.3 \text{ (}^\circ\text{C)} \end{aligned}$$

Lower-limit Temperature Input Setting

$$\begin{aligned} \bar{LNSL} &= \frac{260-40}{105-40} \times \{(110-105)-(25-40)\} + (25-40) \\ &= 52.7 \text{ (}^\circ\text{C)} \end{aligned}$$

Precautions

CAUTION

If this product should malfunction and cease to provide correct output, property damage may occur to the equipment or device that is connected to it. To prevent this, provide additional safety measures by also connecting the equipment or devices to a separate alarm system that will warn operators of temperature rises.



Precautions for Safe Use

1. Use the ES1B only within the ranges specified by its specifications and ratings.
2. Be sure to correctly wire the input sensor leads to the proper positive and negative terminals.
3. Do not use the product in the following locations:
 - Locations subject to icing or condensation.
 - Locations subject to excessive shocks or vibration.
 - Locations subject to dust or corrosive gases.
 - Locations subject to extreme temperature changes or direct sunlight.
 - Locations subject to water splashing or oil contact.

Precautions for Correct Use

1. The thermocouple output and power supply are not isolated. Make sure that unwanted circuit paths are not formed with the equipment or device that is connected to the product.
2. To prevent inductive noise, wire the product separately from high-voltage sources and power lines carrying large currents. Also avoid parallel wiring or shared wiring paths with power lines.
3. Do not allow the filter to become soiled. Use air blow or use a thin cotton swab to clean the filter.

1. Installation

- Select a place where the emissivity is high for measuring the target. If necessary, use black spray or black tape.
- Use the supplied locknuts to fix the ES1B securely in place. Tighten to a torque of 0.5 N·m max.
- When measuring a high-temperature object, use a shield or similar protection to prevent the temperature of the ES1B from rising.

2. Connection

- Connect to the green output lead wire (+), white output lead wire (-), orange power supply lead wire (+), and shield power supply wire (-).
- To measure the temperature difference between two locations, use two isolated power supplies.

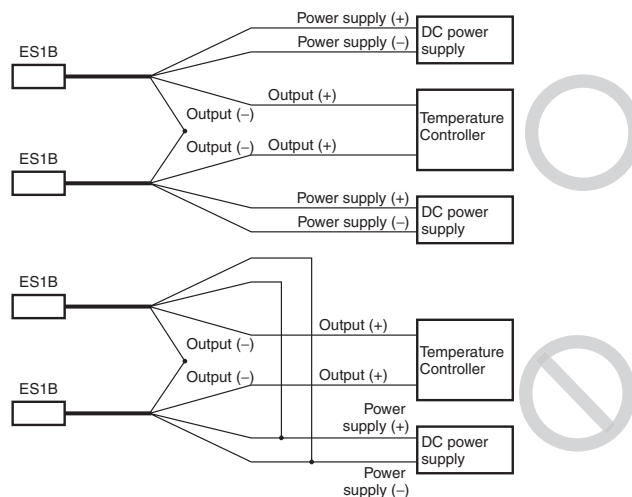

3. Adjustment

- The output impedance of the ES1B is 1 to 4 kΩ. Normally, current leaking to the ES1B from the burnout detection circuit of the temperature controller will offset the measured temperature in a range extending from several degrees to several tens of degrees. When using a controller equipped with an input shift function, use the input shift function to compensate for this offset error in the vicinity of the measuring temperature. For details on this compensation, see Input Shift Method below and the user's manual of the controller being used.
- If the length of a lead wire must be extended, use a K thermocouple compensating conductor for the output lead wires (+, -), and standard copper wire for power supply leads (+, -).
- Do not bend lead wires repeatedly.

4. Cleaning

- Do not use paint thinner or the equivalent for cleaning. Use standard grade alcohol.

Warranty and Application Considerations

Warranty and Limitations of Liability

WARRANTY

OMRON's exclusive warranty is that the products are free from defects in materials and workmanship for a period of one year (or other period if specified) from date of sale by OMRON.

OMRON MAKES NO WARRANTY OR REPRESENTATION, EXPRESS OR IMPLIED, REGARDING NON-INFRINGEMENT, MERCHANTABILITY, OR FITNESS FOR PARTICULAR PURPOSE OF THE PRODUCTS. ANY BUYER OR USER ACKNOWLEDGES THAT THE BUYER OR USER ALONE HAS DETERMINED THAT THE PRODUCTS WILL SUITABLY MEET THE REQUIREMENTS OF THEIR INTENDED USE. OMRON DISCLAIMS ALL OTHER WARRANTIES, EXPRESS OR IMPLIED.

LIMITATIONS OF LIABILITY

OMRON SHALL NOT BE RESPONSIBLE FOR SPECIAL, INDIRECT, OR CONSEQUENTIAL DAMAGES, LOSS OF PROFITS, OR COMMERCIAL LOSS IN ANY WAY CONNECTED WITH THE PRODUCTS, WHETHER SUCH CLAIM IS BASED ON CONTRACT, WARRANTY, NEGLIGENCE, OR STRICT LIABILITY.

In no event shall the responsibility of OMRON for any act exceed the individual price of the product on which liability is asserted.

IN NO EVENT SHALL OMRON BE RESPONSIBLE FOR WARRANTY, REPAIR, OR OTHER CLAIMS REGARDING THE PRODUCTS UNLESS OMRON'S ANALYSIS CONFIRMS THAT THE PRODUCTS WERE PROPERLY HANDLED, STORED, INSTALLED, AND MAINTAINED AND NOT SUBJECT TO CONTAMINATION, ABUSE, MISUSE, OR INAPPROPRIATE MODIFICATION OR REPAIR.

Application Considerations

SUITABILITY FOR USE

OMRON shall not be responsible for conformity with any standards, codes, or regulations that apply to the combination of products in the customer's application or use of the products.

Take all necessary steps to determine the suitability of the product for the systems, machines, and equipment with which it will be used.

Know and observe all prohibitions of use applicable to this product.

NEVER USE THE PRODUCTS FOR AN APPLICATION INVOLVING SERIOUS RISK TO LIFE OR PROPERTY WITHOUT ENSURING THAT THE SYSTEM AS A WHOLE HAS BEEN DESIGNED TO ADDRESS THE RISKS, AND THAT THE OMRON PRODUCTS ARE PROPERLY RATED AND INSTALLED FOR THE INTENDED USE WITHIN THE OVERALL EQUIPMENT OR SYSTEM.

Disclaimers

CHANGE IN SPECIFICATIONS

Product specifications and accessories may be changed at any time based on improvements and other reasons. Consult with your OMRON representative at any time to confirm actual specifications of purchased product.

DIMENSIONS AND WEIGHTS

Dimensions and weights are nominal and are not to be used for manufacturing purposes, even when tolerances are shown.

ALL DIMENSIONS SHOWN ARE IN MILLIMETERS.

To convert millimeters into inches, multiply by 0.03937. To convert grams into ounces, multiply by 0.03527.

Cat. No. H127-E1-01 **In the interest of product improvement, specifications are subject to change without notice.**

OMRON Corporation

Industrial Automation Company

Industrial Devices and Components Division H.Q.

Measuring Components Department

Shiokoji Horikawa, Shimogyo-ku,

Kyoto, 600-8530 Japan

Tel: (81)75-344-7080/Fax: (81)75-344-7189

Printed in Japan

0504-2M (0504) (O)

X-ON Electronics

Largest Supplier of Electrical and Electronic Components

Click to view similar products for [Industrial Temperature Sensors](#) category:

Click to view products by [Omron](#) manufacturer:

Other Similar products are found below :

[590-32AC34-103-WRI](#) [590-59CN02-103](#) [G9864ST22F0](#) [HEL-705-U-0-12-C1](#) [HEL-736-U-2-36](#) [HEL-717-U-0-24-00](#) [519-39AW09-245](#)
[519-39CH01-295](#) [535-32AB36-202](#) [535-34AE08-303](#) [512-32AQ01-503](#) [521-33AG04-303](#) [521-53BR01-503](#) [E52P6DY4M](#) [535-34AE09-222](#)
[590-32AC34-103](#) [590-32AD05-103](#) [HEL-705-U-0-36-00](#) [E52-CA6D-N 4M](#) [E52-P6DY 2M](#) [E52-P20C-N D=8](#) [E52-THE5A 100-200 2M](#)
[HRTS-5760-B-T-0-18](#) [6655-71990001](#) [LTPCTGA20MBSIBX01](#) [LTPCTAA20MDSIEX01](#) [NCP81255MNTXG](#) [HEL-707-T-1-24-00](#) [HEL-](#)
[716-U-0-24-00](#) [USW2247](#) [R-11614-1](#) [RP103ST22P2](#) [R-10331-3F6](#) [B57045K0222K000](#) [B57045K0154K000](#) [PPG102A6](#) [R-7119](#) [R-8949-34](#)
[BB-WTJ-10-36-TT](#) [20006233-00](#) [USW2889](#) [IWTTP200A](#) [IWTTP250A](#) [IWTTP300A](#) [TT4-PT1000B-T180-OM52-500](#) [TT4-PT100B-T180-](#)
[C312-200](#) [TT4-PT100B-T180-OM52-500](#) [NB-PTCO-142](#) [B57045K0682K000](#) [R-10224-16](#)