

# F3S-TGR-CL

## Multi-beam, finger- and hand protection safety sensor

The F3S-TGR-CL multi-beam, finger- and hand protection safety sensors are available in Type 2 (PL c) and Type 4 (PL e) with integrated safety control functions selectable via built-in dip-switches.

- Type 2 or type 4 acc. EN61496-1
- PL c or PL e acc. ISO13849
- Family concept in wiring and mounting
- All models with dip-switch setup for external device monitoring, interlock function, range setting (short and long range) and optical or wired coding
- Advanced models with pre-reset function, T-, L- or X- muting function and muting lamp integrated

### Multi-beam models

- Max. operating range 12 m in active/passive
- Max. operating range 50 m in active/active
- Selectable muting mode (timeout or infinite muting) in advanced models

### Finger- or hand protection models (14, 35 or 70 mm resolution)

- Max. operating range 6 m in 14 mm resolution
- Max. operating range 14 m in 35 or 70 mm resolution
- Selectable muting mode (timeout muting), blanking and single / double brake function in advanced models

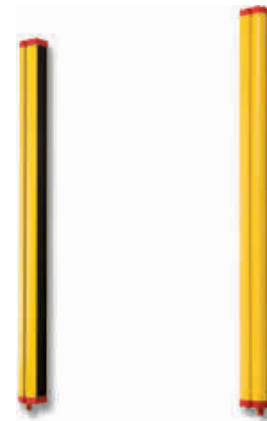

## Model number structure





### Multi-beam safety sensors

F3S-TGR-CL   -K   -  - 

1 2    3 4 5 6

1. Type
  - 2: Type 2
  - 4: Type 4
2. Feature set
  - A: Advanced
  - B: Basic
3. Number of optical axes
  - 2: 2 optical axes
  - 3: 3 optical axes
  - 4: 4 optical axes
4. System
  - \_ : Active/active system
  - C: Active/passive system
5. Protective height [mm]
  - 500, 800, 900, 1,200
6. Additional functions
  - \_ : Standard
  - LD: Long distance (only active/active systems)

### Finger and hand protection safety sensors

F3S-TGR-CL   -  - 

1 2 3 4 5

1. Type
  - 2: Type 2
  - 4: Type 4
2. Feature set
  - A: Advanced
  - B: Basic
3. Resolution
  - 014: Finger protection
  - 035: Hand protection
  - 070: Foot protection (only slave versions)
4. Protective height [mm]
  - 150, 300, 450, 600, 750, 900, 1,050, 1,200, 1,350, 1,500, 1,650, 1,800, 1,950, 2,100, 2,250, (2,400, only standalone versions)
5. Version
  - \_ : Standard
  - M: Master
  - S: Slave

## Ordering information multi-beam safety sensors

### F3S-TGR-CL2\_-K\_ (Type 2)

System	Sensing distance	Detection capability	Order code	
			Basic feature set <sup>1</sup>	Advanced feature set <sup>2</sup>
Active/passive	0.5 m ... 12 m	500	F3S-TGR-CL2B-K2C-500	F3S-TGR-CL2A-K2C-500
	0.5 m ... 8 m	400	F3S-TGR-CL2B-K3C-800	F3S-TGR-CL2A-K3C-800
	0.5 m ... 7 m	300	F3S-TGR-CL2B-K4C-900	F3S-TGR-CL2A-K4C-900
		400	F3S-TGR-CL2B-K4C-1200	F3S-TGR-CL2A-K4C-1200
Active/active	0.5 m ... 40 m	500	F3S-TGR-CL2B-K2-500	F3S-TGR-CL2A-K2-500
		400	F3S-TGR-CL2B-K3-800	F3S-TGR-CL2A-K3-800
		300	F3S-TGR-CL2B-K4-900	F3S-TGR-CL2A-K4-900
		400	F3S-TGR-CL2B-K4-1200	F3S-TGR-CL2A-K4-1200
Active/active, long distance	25 m ... 50 m	500	F3S-TGR-CL2B-K2-500-LD	F3S-TGR-CL2A-K2-500-LD
		400	F3S-TGR-CL2B-K3-800-LD	F3S-TGR-CL2A-K3-800-LD
		300	F3S-TGR-CL2B-K4-900-LD	F3S-TGR-CL2A-K4-900-LD
		400	F3S-TGR-CL2B-K4-1200-LD	F3S-TGR-CL2A-K4-1200-LD

### F3S-TGR-CL4\_-K\_ (Type 4)

System	Sensing distance	Detection capability	Order code	
			Basic feature set <sup>1</sup>	Advanced feature set <sup>2</sup>
Active/passive	0.5 m ... 12 m	500	F3S-TGR-CL4B-K2C-500	F3S-TGR-CL4A-K2C-500
	0.5 m ... 8 m	400	F3S-TGR-CL4B-K3C-800	F3S-TGR-CL4A-K3C-800
	0.5 m ... 7 m	300	F3S-TGR-CL4B-K4C-900	F3S-TGR-CL4A-K4C-900
		400	F3S-TGR-CL4B-K4C-1200	F3S-TGR-CL4A-K4C-1200
Active/active	0.5 m ... 40 m	500	F3S-TGR-CL4B-K2-500	F3S-TGR-CL4A-K2-500
		400	F3S-TGR-CL4B-K3-800	F3S-TGR-CL4A-K3-800
		300	F3S-TGR-CL4B-K4-900	F3S-TGR-CL4A-K4-900
		400	F3S-TGR-CL4B-K4-1200	F3S-TGR-CL4A-K4-1200
Active/active, long distance	25 m ... 50 m	500	F3S-TGR-CL4B-K2-500-LD	F3S-TGR-CL4A-K2-500-LD
		400	F3S-TGR-CL4B-K3-800-LD	F3S-TGR-CL4A-K3-800-LD
		300	F3S-TGR-CL4B-K4-900-LD	F3S-TGR-CL4A-K4-900-LD
		400	F3S-TGR-CL4B-K4-1200-LD	F3S-TGR-CL4A-K4-1200-LD

<sup>1</sup> Basic feature set: Manual/automatic restart, coding

<sup>2</sup> Advanced feature set: Basic + Muting + integrated Muting lamp + Pre-reset

## Ordering information safety sensors

### F3S-TGR-CL2\_ (Type 2)

Feature set	Master/Slave	Sensing distance	Detection capability	Order code	Length
Basic <sup>1</sup>	Standalone	0.2 m ... 6 m	14 mm	F3S-TGR-CL2B-014- _	150 mm ... 2400 mm <sup>3</sup>
		0.2 m ... 14 m	35 mm	F3S-TGR-CL2B-035- _	
Advanced <sup>2</sup>	Standalone	0.2 m ... 6 m	14 mm	F3S-TGR-CL2A-014- _	
		0.2 m ... 14 m	35 mm	F3S-TGR-CL2A-035- _	
	Master	0.2 m ... 6 m	14 mm	F3S-TGR-CL2A-014- _M	150 mm ... 2250 mm <sup>3</sup>
		0.2 m ... 14 m	35 mm	F3S-TGR-CL2A-035- _M	
	Slave	0.2 m ... 6 m	14 mm	F3S-TGR-CL2A-014- _S	
		0.2 m ... 14 m	35 mm	F3S-TGR-CL2A-035- _S	300 mm ... 2100 mm
		70 mm	F3S-TGR-CL2A-070- _S		

### F3S-TGR-CL4\_ (Type 4)

Feature set	Master/Slave	Sensing distance	Detection capability	Order code	Length
Basic <sup>1</sup>	Standalone	0.2 m ... 6 m	14 mm	F3S-TGR-CL4B-014- _	150 mm ... 2400 mm <sup>3</sup>
		0.2 m ... 14 m	35 mm	F3S-TGR-CL4B-035- _	
Advanced <sup>2</sup>	Standalone	0.2 m ... 6 m	14 mm	F3S-TGR-CL4A-014- _	
		0.2 m ... 14 m	35 mm	F3S-TGR-CL4A-035- _	
	Master <sup>4</sup>	0.2 m ... 6 m	14 mm	F3S-TGR-CL4A-014- _M	150 mm ... 2250 mm <sup>3</sup>
		0.2 m ... 14 m	35 mm	F3S-TGR-CL4A-035- _M	
	Slave <sup>4</sup>	0.2 m ... 6 m	14 mm	F3S-TGR-CL4A-014- _S	
		0.2 m ... 14 m	35 mm	F3S-TGR-CL4A-035- _S	300 mm ... 2100 mm
		70 mm	F3S-TGR-CL4A-070- _S		

<sup>1</sup> Basic feature set: Manual/automatic restart, coding

<sup>2</sup> Advanced feature set: Basic + Muting + integrated Muting lamp + Pre-reset

<sup>3</sup> Available length (in mm): 150, 300, 450, 600, 750, 900, 1,050, 1,200, 1,350, 1,500, 1,650, 1,800, 1,950, 2,100, 2,250, (2,400 mm, only standalone versions)

<sup>4</sup> Master/slave system: A master/slave system cannot exceed the total length of 2,400 mm

### F3S-TGR-CL- \_ M/S Master-Slave Series

- A Master-Slave cascade system is made of one master segment and one slave segment.
- The length of the total protective field can vary from minimum 300 mm till maximum 2,400 mm.
- The interconnect cable length limitation between master and slave segment is in total max. 0,9 m.

Possible combinations of master and slave are in this table:

		Slave models																				
		14 mm or 35 mm resolution														70 mm resolution						
		150	300	450	600	750	900	1,050	1,200	1,350	1,500	1,650	1,800	1,950	2,150	2,250	300	600	900	1,200	1,500	1,800
Master models (14 mm or 35 mm resolution)	150	OK	OK	OK	OK	OK	OK	OK	OK	OK	OK	OK	OK	OK	OK	OK	OK	OK	OK	OK	OK	OK
	300	OK	OK	OK	OK	OK	OK	OK	OK	OK	OK	OK	OK	OK	OK		OK	OK	OK	OK	OK	OK
	450	OK	OK	OK	OK	OK	OK	OK	OK	OK	OK	OK	OK	OK			OK	OK	OK	OK	OK	OK
	600	OK	OK	OK	OK	OK	OK	OK	OK	OK	OK	OK	OK				OK	OK	OK	OK	OK	OK
	750	OK	OK	OK	OK	OK	OK	OK	OK	OK	OK	OK					OK	OK	OK	OK	OK	
	900	OK	OK	OK	OK	OK	OK	OK	OK	OK	OK						OK	OK	OK	OK	OK	
	1,050	OK	OK	OK	OK	OK	OK	OK	OK	OK							OK	OK	OK	OK		
	1,200	OK	OK	OK	OK	OK	OK	OK	OK								OK	OK	OK	OK		
	1,350	OK	OK	OK	OK	OK	OK	OK	OK								OK	OK	OK			
	1,500	OK	OK	OK	OK	OK	OK	OK									OK	OK	OK			
	1,650	OK	OK	OK	OK	OK											OK	OK				
	1,800	OK	OK	OK	OK												OK	OK				
1,950	OK	OK	OK													OK						
2,100	OK	OK														OK						
2,250	OK															OK						

## Ordering information Accessories

### Receiver Cables (M12-8pin, shielded, flying leads)

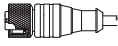
Shape	Description	Order code	Remark
	Sensor connector with open cable end M12-8pin, outer shielding layer	Y92E-M12PURSH8S2M-L	Receiver cable, 2 m length
		Y92E-M12PURSH8S5M-L	Receiver cable, 5 m length
		Y92E-M12PURSH8S10M-L	Receiver cable, 10 m length
		Y92E-M12PURSH8S25M-L	Receiver cable, 25 m length

### Transmitter Cables (M12-4pin, shielded, flying leads)

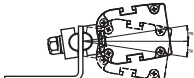

Shape	Description	Order code	Remark
	Sensor connector with open cable end M12-4pin, outer shielding layer	Y92E-M12PURSH4S2M-L	Transmitter cable, 2 m length
		Y92E-M12PURSH4S5M-L	Transmitter cable, 5 m length
		Y92E-M12PURSH4S10M-L	Transmitter cable, 10 m length
		Y92E-M12PURSH4S25M-L	Transmitter cable, 25 m length

### Mounting brackets

Shape	Description	Order code	Remark
	Mounting bracket	F39-TGR-ST-SB <sup>*1</sup>	Mounting bracket × 1, SLC mounting screws × 1 set
	Adjustable bracket	F39-TGR-ST-ADJ	Adjustable bracket × 1, Bracket mounting screws × 1 set

\*1 Brackets amount included in shipment is shown in table of Dimensions

### Master-Slave Accessories

Shape	Description	Order code	Remark
	Male-male extension connector M12-8pin, outer shielding layer	Y92E-M12MSM12MSPURSH80.3M-L	Connection cable, 0.3 m length
		Y92E-M12MSM12MSPURSH80.9M-L (included in slave system)	Connection cable, 0.9 m length
	Alignment kit – end cap	F39-TGR-CL-MSA (included in slave system)	To support alignment of a Master-Slave system

### Laser alignment kit

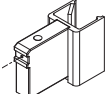
Shape	Description	Order code	Remark
	Laser alignment kit	F39-TGR-CL-LLK	Scanning range: ≤ 60 m Batteries: 2 × 1.5 V Micro/AAA Laser Class 2 (IEC 60825)

## Specifications

### Multi-beam safety sensors

Item	F3S-TGR-CL2_-0__	F3S-TGR-CL4_-0__
Sensor type	Type 2	Type 4
Protective height	500 mm, 800 mm, 900 mm or 1,200 mm	
Operating range:	F3S-TGR-CL__-K_ 0.5 to 20 m or 20 to 40 m (Dip switch option) F3S-TGR-CL__-K_-LD 25 to 50 m F3S-TGR-CL__-K2C-500 0.5 to 12 m F3S-TGR-CL__-K3C-800 0.5 to 8 m F3S-TGR-CL__-K4C-___ 0.5 to 7 m	
Beam pitch	F3S-TGR-CL__-K2_-500: 2 beams, 500 mm F3S-TGR-CL__-K3_-800: 3 beams, 400 mm F3S-TGR-CL__-K4_-900: 4 beams, 300 mm F3S-TGR-CL__-K4_-1200: 4 beams, 400 mm	
Effective aperture angle (EAA)	Within ±5°	Within ±2.5°
	for the emitter and receiver at a detection distance of at least 3 m according to IEC 61496-2	
Light source	Infrared LED (880 nm), power dissipation <3 mW, Class 1 per EN 60825-1	
Supply voltage	24 VDC ±20%, according EN 60204-1 able to cover a drop of voltage of at least 20 ms	
OSSD	2 PNP transistor outputs, load current 2 × 250 mA max	
Test functions	Self test (after power ON and during operation)	

Item	F3S-TGR-CL2_-0__	F3S-TGR-CL4_-0__
<b>Safety-related functions</b>	All models with dip-switch setup for external device monitoring, interlock function, range setting (short and long range) and optical or wired sync Advanced models with selectable pre-reset function, T-, L- or X- muting function (timeout or infinite muting dip switch option) and muting lamp integrated	
<b>Response time</b>	ON to OFF: Maximum: 13 ms	
<b>Ambient temperature</b>	Operating: -10 to 55°C, Storage: -25°C to 70°C (no icing, no condensation)	
<b>Ambient humidity</b>	95% not condensing	
<b>Degree of protection</b>	IP 65 (IEC 60529)	
<b>Materials</b>	Housing: Painted aluminum, Yellow, RAL 1018 Front Window: Acrylic Lexan Red end cap: PA6 (Standalone models), Transparent end cap: PC (Advanced standalone models), Sealing Gasket: EPDM Mounting Bracket: Cold rolled Steel	
<b>Suitable for safety control systems</b>	PLc (ISO 13849-1)	PLe (ISO 13849-1)
<b>Category</b>	Categorie 2	Categorie 4
<b>PFHd</b>	2.5 × 10 <sup>-9</sup>	
<b>Proof test interval</b>	every 20 years	

## Finger- and hand safety protection sensors

Item	F3S-TGR-CL2_-0__	F3S-TGR-CL4_-0__
<b>Sensor type</b>	Type 2	Type 4
<b>Protective height</b>	150 mm - 2,400 mm	
<b>Operating range: (short setting or long setting)</b>	F3S-TGR-CL__-014: 0.2 m to 3 m or 3 m to 6 m (Dip switch option) F3S-TGR-CL__-035: 0.2 m to 7 m or 7 m to 14 m (Dip switch option) F3S-TGR-CL__-070: 0.2 m to 7 m or 7 m to 14 m (Dip switch option)	
<b>Detection capability</b>	F3S-TGR-CL__-014: Opaque objects 14 mm in diameter F3S-TGR-CL__-035: Opaque objects 35 mm in diameter F3S-TGR-CL__-070: Opaque objects 70 mm in diameter	
<b>Effective aperture angle (EAA)</b>	Within ±5°	Within ±2.5°
	for the emitter and receiver at a detection distance of at least 3 m according to IEC 61496-2	
<b>Light source</b>	Infrared LED (880 nm), power dissipation <3 mW, Class 1 per EN 60825-1	
<b>Supply voltage</b>	24 VDC ±20%, according EN 60204-1 able to cover a drop of voltage of at least 20 ms	
<b>OSSD</b>	2 PNP transistor outputs, load current 2 × 250 mA max	
<b>Series connection</b>	Number of connections: One master and one slave safety light curtain Total number of beams ≤ 336 Maximum interconnect cable length: 900 mm	
<b>Test functions</b>	Self test (after power ON and during operation)	
<b>Safety-related functions</b>	All models with dip-switch setup for external device monitoring, interlock function, range setting (short and long range) and optical or wired sync. Advanced models with selectable pre-reset function, T-, L- or X- muting function (timeout muting), blanking, single / double brake function and muting lamp integrated	
<b>Response time</b>	ON to OFF: 14 ms to 103 ms	
<b>Ambient temperature</b>	Operating: -10°C to +55°C, Storage: -25°C to +70°C (no icing, no condensation)	
<b>Ambient humidity</b>	95% not condensing	
<b>Degree of protection</b>	IP 65 (IEC 60529)	
<b>Materials</b>	Housing: Painted aluminum, Yellow, RAL 1018 Front Window: Acrylic Lexan Red end cap: PA6 (Standalone models), Transparent end cap: PC (Advanced standalone models), Die cast aluminium (Master-, Slave models) Sealing Gasket: EPDM Mounting Bracket: Cold rolled Steel	
<b>Suitable for safety control systems</b>	PLc (ISO 13849-1)	PLe (ISO 13849-1)
<b>Category</b>	Categorie 2	Categorie 4
<b>PFHd</b>	2.5 × 10 <sup>-9</sup>	
<b>Proof test interval</b>	every 20 years	

## Dimensions

### F3S-TGR-CL system data with 14 mm, 35 mm and 70 mm resolution

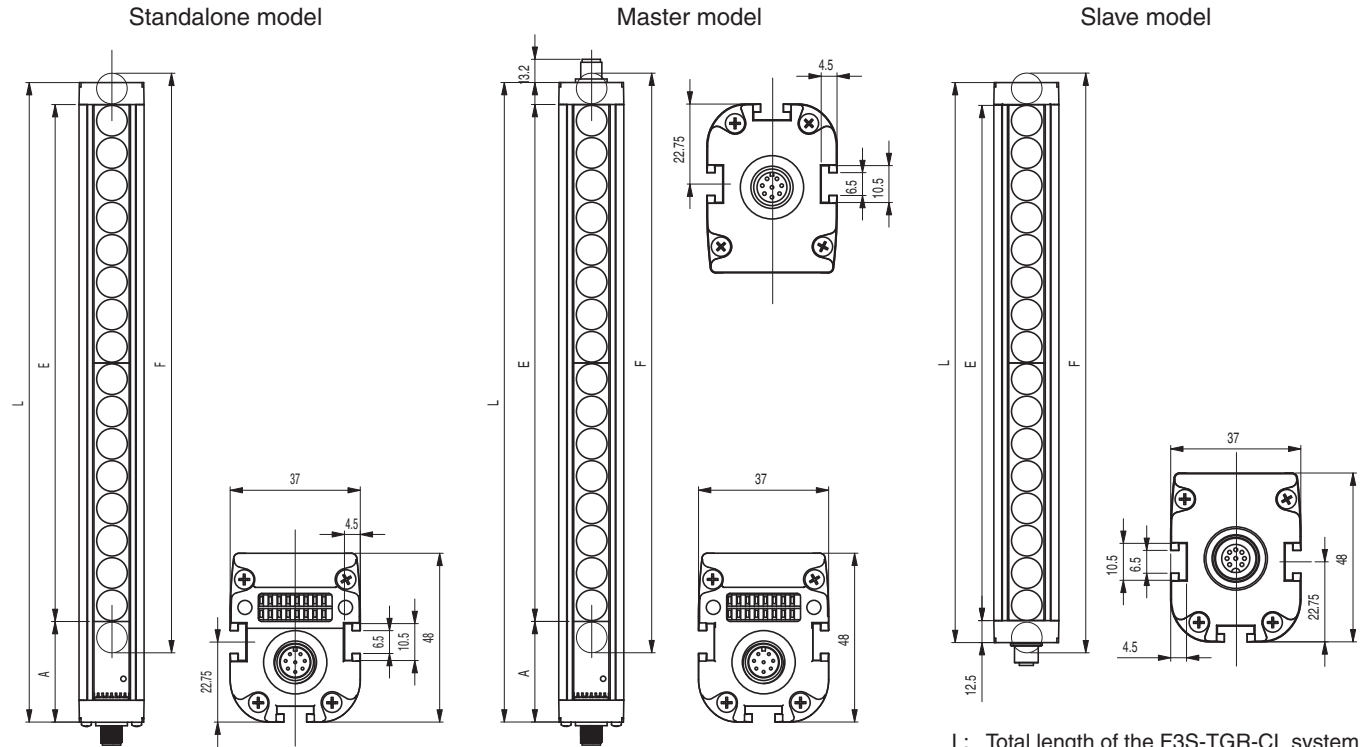

L: Total length of the F3S-TGR-CL system  
 F: Protective height where an object equal or greater the resolution is detected  
 E: Detection zone  
 A: Dead zone without detection capability

#### Standalone and Master models

Model code		150	300	450	600	750	900	1050	1200	1350	1500	1650	1800	1950	2100	2250	2400
Stand-alone and Master models	L [mm]	217	364	511	658	805	952	1,099	1,246	1,393	1,540	1,687	1,834	1,981	2,128	2,275	2,422
	E [mm]	147	294	441	588	735	882	1,029	1,176	1,323	1,470	1,617	1,764	1,911	2,058	2,205	2,352
	Weight [kg]	1.0	1.4	1.9	2.5	3.0	3.6	4.1	4.7	5.3	5.8	6.4	7.0	7.5	8.1	8.6	9.2
14 mm	F [mm]	161	308	455	602	749	896	1,043	1,190	1,337	1,484	1,631	1,778	1,925	2,072	2,219	2,366
35 mm	F [mm]	182	329	476	623	770	917	1,064	1,211	1,358	1,505	1,652	1,799	1,946	2,093	2,240	2,352
Mounting brackets (F39-TGR-ST-SB) included in shipment		4					6			8			10		12		

#### Slave models

Model code		150	300	450	600	750	900	1050	1200	1350	1500	1650	1800	1950	2100	2250	
Slave models	L [mm]	172	319	466	613	760	907	1,054	1,201	1,348	1,495	1,642	1,798	1,936	2,083	2,230	
	E [mm]	147	294	441	588	735	882	1,029	1,176	1,323	1,470	1,617	1,764	1,911	2,058	2,205	
	Weight [kg]	0.8	1.2	1.7	2.3	2.8	3.4	3.9	4.5	5.1	5.6	6.2	6.8	7.3	7.9	8.4	
14 mm	F [mm]	161	308	455	602	749	896	1,043	1,190	1,337	1,484	1,631	1,778	1,925	2,072	2,219	
35 mm	F [mm]	182	329	476	623	770	917	1,064	1,211	1,358	1,505	1,652	1,799	1,946	2,093	2,240	
70 mm	F [mm]	—	347	—	641	—	931	—	1,229	—	1,523	—	1,817	—	2,111	—	
Mounting brackets (F39-TGR-ST-SB) included in shipment		4					6			8			10		12		

## F3S-TGR-CL-K system data

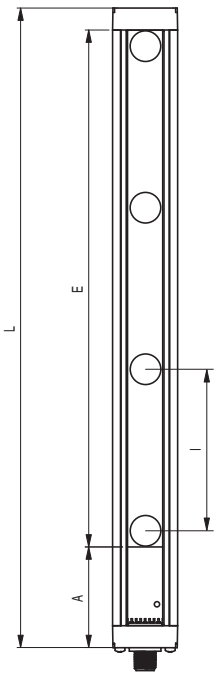

- L: Total length of the F3S-TGR-CL system
- I: Beam distance
- E: Detection zone
- A: Dead zone without detection capability

Model code	500	800	900	1200	
all models	L [mm]	682	982	1,082	1,382
	E [mm]	518	818	918	1,218
	Weight [kg]	2.3	3.2	4.1	4.9
	I [mm]	500	400	300	400
Mounting brackets (F39-TGR-ST-SB) included in shipment	4		6		

## Wiring example

### F3S-TGR-CL in automatic mode and G9SB-301-D in manual mode

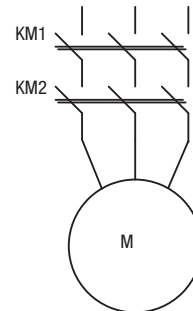
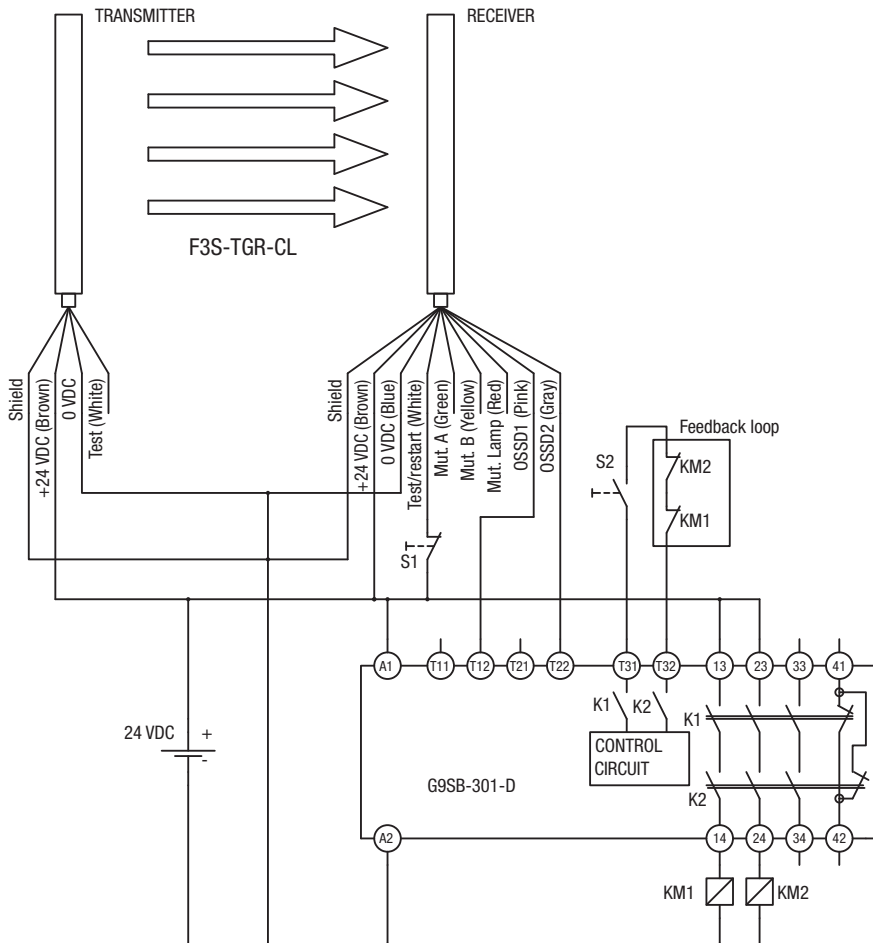

Note: This circuit achieves up to PLe according to EN ISO 13849-1 with F3S-TGR-CL4 and up to PLc according to EN ISO 13849-1 with F3S-TGR-CL2.

## Read and Understand This Catalog

Please read and understand this catalog before purchasing the products. Please consult your OMRON representative if you have any questions or comments.

## Warranty and Limitations of Liability

### WARRANTY

OMRON's exclusive warranty is that the products are free from defects in materials and workmanship for a period of one year (or other period if specified) from date of sale by OMRON.

OMRON MAKES NO WARRANTY OR REPRESENTATION, EXPRESS OR IMPLIED, REGARDING NON-INFRINGEMENT, MERCHANTABILITY, OR FITNESS FOR PARTICULAR PURPOSE OF THE PRODUCTS. ANY BUYER OR USER ACKNOWLEDGES THAT THE BUYER OR USER ALONE HAS DETERMINED THAT THE PRODUCTS WILL SUITABLY MEET THE REQUIREMENTS OF THEIR INTENDED USE. OMRON DISCLAIMS ALL OTHER WARRANTIES, EXPRESS OR IMPLIED.

### LIMITATIONS OF LIABILITY

OMRON SHALL NOT BE RESPONSIBLE FOR SPECIAL, INDIRECT, OR CONSEQUENTIAL DAMAGES, LOSS OF PROFITS OR COMMERCIAL LOSS IN ANY WAY CONNECTED WITH THE PRODUCTS, WHETHER SUCH CLAIM IS BASED ON CONTRACT, WARRANTY, NEGLIGENCE, OR STRICT LIABILITY.

In no event shall the responsibility of OMRON for any act exceed the individual price of the product on which liability is asserted.

IN NO EVENT SHALL OMRON BE RESPONSIBLE FOR WARRANTY, REPAIR, OR OTHER CLAIMS REGARDING THE PRODUCTS UNLESS OMRON'S ANALYSIS CONFIRMS THAT THE PRODUCTS WERE PROPERLY HANDLED, STORED, INSTALLED, AND MAINTAINED AND NOT SUBJECT TO CONTAMINATION, ABUSE, MISUSE, OR INAPPROPRIATE MODIFICATION OR REPAIR.

## Application Considerations

### SUITABILITY FOR USE

OMRON shall not be responsible for conformity with any standards, codes, or regulations that apply to the combination of products in the customer's application or use of the products.

At the customer's request, OMRON will provide applicable third party certification documents identifying ratings and limitations of use that apply to the products. This information by itself is not sufficient for a complete determination of the suitability of the products in combination with the end product, machine, system, or other application or use.

The following are some examples of applications for which particular attention must be given. This is not intended to be an exhaustive list of all possible uses of the products, nor is it intended to imply that the uses listed may be suitable for the products:

- Outdoor use, uses involving potential chemical contamination or electrical interference, or conditions or uses not described in this catalog.
- Nuclear energy control systems, combustion systems, railroad systems, aviation systems, medical equipment, amusement machines, vehicles, safety equipment, and installations subject to separate industry or government regulations.
- Systems, machines, and equipment that could present a risk to life or property.

Please know and observe all prohibitions of use applicable to the products.

NEVER USE THE PRODUCTS FOR AN APPLICATION INVOLVING SERIOUS RISK TO LIFE OR PROPERTY WITHOUT ENSURING THAT THE SYSTEM AS A WHOLE HAS BEEN DESIGNED TO ADDRESS THE RISKS, AND THAT THE OMRON PRODUCTS ARE PROPERLY RATED AND INSTALLED FOR THE INTENDED USE WITHIN THE OVERALL EQUIPMENT OR SYSTEM.

### PROGRAMMABLE PRODUCTS

OMRON shall not be responsible for the user's programming of a programmable product, or any consequence thereof.

## Disclaimers

### CHANGE IN SPECIFICATIONS

Product specifications and accessories may be changed at any time based on improvements and other reasons.

It is our practice to change model numbers when published ratings or features are changed, or when significant construction changes are made. However, some specifications of the products may be changed without any notice. When in doubt, special model numbers may be assigned to fix or establish key specifications for your application on your request. Please consult with your OMRON representative at any time to confirm actual specifications of purchased products.

### DIMENSIONS AND WEIGHTS

Dimensions and weights are nominal and are not to be used for manufacturing purposes, even when tolerances are shown.

### PERFORMANCE DATA

Performance data given in this catalog is provided as a guide for the user in determining suitability and does not constitute a warranty. It may represent the result of OMRON's test conditions, and the users must correlate it to actual application requirements. Actual performance is subject to the OMRON Warranty and Limitations of Liability.

### ERRORS AND OMISSIONS

The information in this document has been carefully checked and is believed to be accurate; however, no responsibility is assumed for clerical, typographical, or proofreading errors, or omissions.

Cat. No. F07E-EN-03

**In the interest of product improvement, specifications are subject to change without notice.**

## OMRON EUROPE B.V.

Wegalaan 67-69,  
NL-2132 JD, Hoofddorp,  
The Netherlands  
Phone: +31 23 568 13 00  
Fax: +31 23 568 13 88  
www.industrial.omron.eu



## X-ON Electronics

Largest Supplier of Electrical and Electronic Components

*Click to view similar products for [Safety Light Curtains](#) category:*

*Click to view products by [Omron](#) manufacturer:*

Other Similar products are found below :

[F39EJR](#) [F39FU1M](#) [F39JA1C](#) [F39GCN4D](#) [406500050](#) [70230-1180](#) [F39-LJ1](#) [F39-LJ2](#) [F39-PTJ](#) [FF-SPS47TRG](#) [120257-0036](#) [120257-0035](#)  
[120257-0033](#) [120257-0031](#) [120257-0026](#) [120257-0023](#) [120257-0019](#) [120257-0017](#) [120255-0038](#) [120255-0036](#) [F39-JD7A-D](#) [42370](#) [NA1-](#)  
[PK3](#) [NA1-PK5](#) [SFB-CCB3-MU](#) [SFB-CCB3](#) [MS-SFD-1-5](#) [SF4D-TM1](#) [SFD-CCB10-S](#) [SFD-CCB3](#) [SFD-CCB5-S](#) [SFD-CCB7](#) [SF4D-H16](#)  
[40636-0010](#) [MS-SFB-1](#) [NA1-11-PN](#) [NA1-PK3-PN](#) [SF4C-H12](#) [SF4C-H24](#) [SFB-CB05](#) [SFC-HC](#) [FF-SYZ101092E](#) [MS-SFD-3-6](#) [40653-0010](#)  
[F39-CN5](#) [F39-JD10A](#) [F39-JD3A](#) [F39-JD3B](#) [F39-JD5B](#) [F39-JD7A](#)