

# General-purpose Relay G2R-□-S (S)

CSM\_G2R-\_S\_(S)\_DS\_E\_2\_1

## Slim and Space-saving Power Plug-in Relay

- Reduces wiring work by 60% when combined with the P2RF-□-PU Push-In Plus Socket (according to actual OMRON measurements).
- Lockable test button models available.
- Built-in mechanical operation indicator.
- Provided with nameplate.
- AC type is equipped with a coil-disconnection self-diagnostic function (LED type).
- High switching power (1-pole: 10 A).

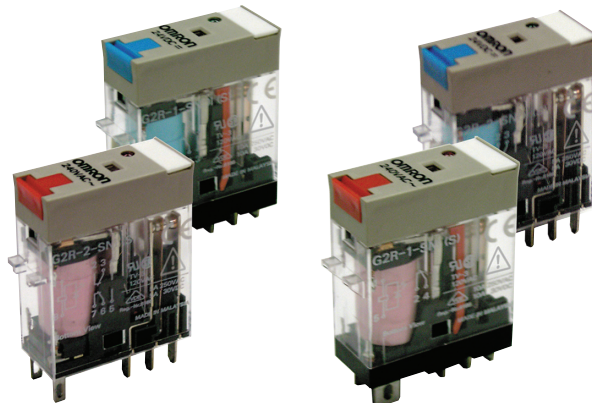

For the most recent information on models that have been certified for safety standards, refer to your OMRON website.

## Model Number Structure

### Model Number Legend

G2R - □ - S □ □ (S)  
1 2 3 4 5

#### 1. Number of Poles

- 1: 1 pole
- 2: 2 poles

#### 2. Terminals

- S: Plug-in

#### 3. Classification

- Blank: General-purpose
- N: LED indicator
- D: Diode
- ND: LED indicator and diode
- NI: LED indicator with test button
- NDI: LED indicator and diode with test button

#### 4. Rated Coil Voltage

#### 5. Mechanical operation indicator and Nameplate

- (S): Models with mechanical operation indicator and Nameplate

**Note:** Contact your OMRON representative for Relays with gold-plated contacts.

## Ordering Information

When your order, specify the rated voltage.

## List of Models

| Classification                           | Coil ratings                                      | Contact form          |                       |
|------------------------------------------|---------------------------------------------------|-----------------------|-----------------------|
|                                          |                                                   | SPDT                  | DPDT                  |
| General-purpose                          | AC 24, 48, 110, 120, 230, 240<br>DC 6, 12, 24, 48 | <b>G2R-1-S (S)</b>    | <b>G2R-2-S (S)</b>    |
| LED indicator                            |                                                   | <b>G2R-1-SN (S)</b>   | <b>G2R-2-SN (S)</b>   |
| LED indicator with test button           |                                                   | <b>G2R-1-SNI (S)</b>  | <b>G2R-2-SNI (S)</b>  |
| Diode                                    | DC 6, 12, 24, 48                                  | <b>G2R-1-SD (S)</b>   | <b>G2R-2-SD (S)</b>   |
| LED indicator and diode                  |                                                   | <b>G2R-1-SND (S)</b>  | <b>G2R-2-SND (S)</b>  |
| LED indicator and diode with test button |                                                   | <b>G2R-1-SNDI (S)</b> | <b>G2R-2-SNDI (S)</b> |

**Note: 1.** The standard models are compliant with UL/CSA and VDE standards. Also, an EC compliance declaration has been made for combinations with the P2RF-□-E, P2RF-□-S and P2RF-□-PU. The Relays bear the CE Marking.

**2.** Refer to *Connecting Sockets*, below, for applicable Socket models.

**3.** When ordering, add the rated coil voltage and "(S)" to the model number. Rated coil voltages are given in the coil ratings table.







Example: G2R-1-S 12 VDC (S)

□ Rated coil voltage

## Accessories (Order Separately)

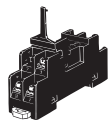
### Connecting Sockets

#### Track/surface-mounting Socket

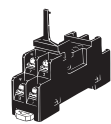
| Applicable relay model*1 | Mounting Method                       | Conductive part protection                 | Terminal Type                    | Applicable crimp terminal/<br>Electric wire                        | Exclusive short bar<br>(Order Separately) | Appearance                                                                            | Model                       |
|--------------------------|---------------------------------------|--------------------------------------------|----------------------------------|--------------------------------------------------------------------|-------------------------------------------|---------------------------------------------------------------------------------------|-----------------------------|
| G2R-1-S                  | Mounted on a DIN track or with screws | Available                                  | Push-In Plus Terminal            | Ferrules<br>Solid wire<br>Stranded wire                            | Available                                 |    | P2RF-05-PU *2               |
|                          |                                       |                                            | Screw terminal (M3 screw size)   | Forked terminals<br>Solid wire<br>Stranded wire                    | Available                                 |    | P2RFZ-05-E *4<br><i>NEW</i> |
|                          |                                       | Option (Terminal cover sold separately) *3 | Screw terminal (M3.5 screw size) | Round terminals<br>Forked terminals<br>Solid wire<br>Stranded wire | Available                                 |    | P2RFZ-05<br><i>NEW</i>      |
|                          |                                       | None                                       |                                  | None                                                               | None                                      |    | P2RF-05                     |
| G2R-2-S                  | Mounted on a DIN track or with screws | Available                                  | Push-In Plus Terminal            | Ferrules<br>Solid wire<br>Stranded wire                            | Available                                 |   | P2RF-08-PU *2               |
|                          |                                       |                                            | Screw terminal (M3 screw size)   | Forked terminals<br>Solid wire<br>Stranded wire                    | Available                                 |  | P2RFZ-08-E *4<br><i>NEW</i> |
|                          |                                       | Option (Terminal cover sold separately) *3 | Screw terminal (M3.5 screw size) | Round terminals<br>Forked terminals<br>Solid wire<br>Stranded wire | Available                                 |  | P2RFZ-08<br><i>NEW</i>      |
|                          |                                       | None                                       |                                  | None                                                               | None                                      |  | P2RF-08                     |







\*1. The applicable relay model is a plug-in terminal type.

\*2. There are screw mounting holes in the DIN hooks on the P2RF-□□-PU. Pull out the DIN hook tabs to mount the Sockets with screws.

\*3. Terminal cover type is P2CZ-Z. (Order Separately) For details, refer to the on page 6.

\*4. The finger-protection type (P2RFZ-□□-E) is a type in which the terminal cover is integrated into the socket. Round terminals cannot be used. Use forked terminals or ferrules instead.

**Back-mounting Socket**

| Applicable Relay model | Mounting Method  | Appearance                                                                          | Models   |
|------------------------|------------------|-------------------------------------------------------------------------------------|----------|
| G2R-1-S                | PCB terminals    |    | P2R-05P  |
|                        |                  |    | P2R-057P |
|                        | Solder terminals |    | P2R-05A  |
| G2R-2-S                | PCB terminals    |    | P2R-08P  |
|                        |                  |    | P2R-087P |
|                        | Solder terminals |  | P2R-08A  |

**For Push-In Plus Terminal Block Sockets**

**Short Bars**

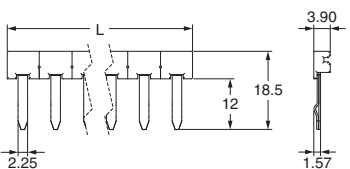
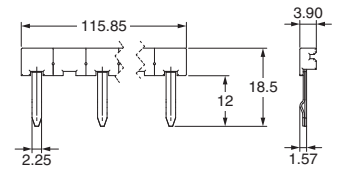
| Applicable sockets       | Pitch   | Application                         | Shape/external dimensions                                                           | Number of poles | L (Length) | Insulation color                 | Short Bars Model*1 |
|--------------------------|---------|-------------------------------------|-------------------------------------------------------------------------------------|-----------------|------------|----------------------------------|--------------------|
| P2RF-05-PU<br>P2RF-08-PU | 7.75 mm | Bridging contact terminals (common) |  | 2               | 15.1       | Red (R)<br>Blue (S)<br>Yellow(Y) | PYDN-7.75-020□     |
|                          |         |                                     |                                                                                     | 3               | 22.85      |                                  | PYDN-7.75-030□     |
|                          |         |                                     |                                                                                     | 4               | 30.6       |                                  | PYDN-7.75-040□     |
|                          |         |                                     |                                                                                     | 20              | 154.6      |                                  | PYDN-7.75-200□     |
|                          | 15.5 mm | For Coil terminals                  |  | 8               | 115.55     |                                  | PYDN-15.5-080□     |

\*1. Replace the box (□) in the model number with the code for the covering color. □Color selection: R = Red, S = Blue, Y = Yellow

**Labels**

| Applicable sockets       | Model                               |
|--------------------------|-------------------------------------|
| P2RF-05-PU<br>P2RF-08-PU | XW5Z-P4.0LB1<br>(1 sheet/60 pieces) |

**For Screw Terminal Sockets**

**Short Bars**

| Applicable sockets       | Pitch   | Appearance | Dimensions (mm) | Number of poles | Insulation color | Short Bars Model | Maximum carry current | Minimum order (set) |
|--------------------------|---------|------------|-----------------|-----------------|------------------|------------------|-----------------------|---------------------|
| P2RFZ-05-E<br>P2RFZ-08-E | 6.8 mm  |            |                 | 20              | Blue(S)          | P2DN-6.8-100S    | 20 A                  | 1                   |
|                          | 15.7 mm |            |                 | 10              |                  | P2DN-15.7-100S   |                       |                     |
| P2RFZ-05<br>P2RFZ-08     | 8.5 mm  |            |                 | 20              | Blue(S)          | P2DN-8.5-100S    | 20 A                  | 1                   |
|                          | 19.4 mm |            |                 | 10              |                  | P2DN-19.4-100S   |                       |                     |

- Note:**
1. Select an applicable type of short bars by checking applicable socket type, appearance, and dimensions.
  2. Use the Short Bars for crossover wiring within one Socket or between Sockets.
  3. Cannot be used on the P2RF-05, P2RF-08.
  4. Use the short bars on the lower section of the socket.  
When using the short bars on the upper section of the socket, insert them so that their heads are pointed upwards (see the figure below). Otherwise, short bars may interfere with the socket, leading to improper wiring and contact failure.

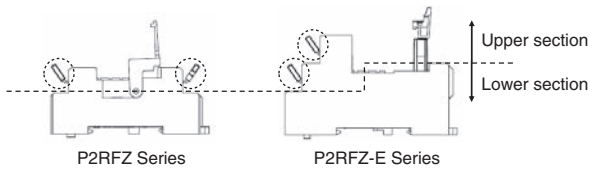

\* One set (order unit) contains 10 short bars and 20 caps.

**Accessories for Short Bars (P2DN)**

**Cap**

| Short Bars Models                                                  | Appearance | Dimensions (mm) | Model      |
|--------------------------------------------------------------------|------------|-----------------|------------|
| P2DN-8.5-100S<br>P2DN-19.4-100S<br>P2DN-6.8-100S<br>P2DN-15.7-100S |            |                 | P2DN-CP100 |

## For Screw Terminal Sockets (P2RFZ-05/P2RFZ-08)

### Terminal covers

| Applicable sockets   | Appearance                                                                        | Model  | Minimum order (set) |
|----------------------|-----------------------------------------------------------------------------------|--------|---------------------|
| P2RFZ-05<br>P2RFZ-08 |  | P2CZ-C |                     |

- Note:**
1. These covers cannot be used for P2RF-05 and P2RF-08.
  2. Use these covers in a combination with P2RFZ-05 and P2RFZ-08.
  3. Do not install short bars (optional) on the upper section (see the figure below). Short bars may interfere with the terminal cover, making the terminal cover unusable.

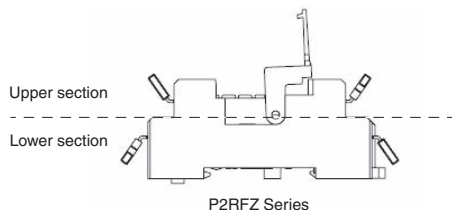

### Dimensions with terminal cover

#### P2RFZ-05

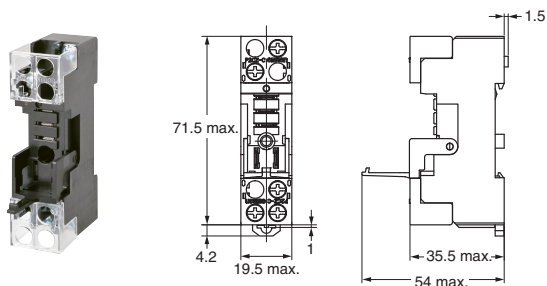

#### P2RFZ-08

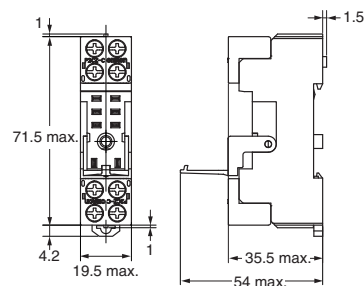

### Labels

| Applicable sockets | Model        | Minimum order (sheet)<br>(quantity per sheet) |
|--------------------|--------------|-----------------------------------------------|
| P2RFZ-□-E          | XW5Z-P2.5LB1 | 5<br>1 sheet (72 pieces)                      |

**Note:** This label cannot be applied on sockets other than P2RFZ-□-E.

### Mounting Tracks

| Applicable Socket       | Description       | Model                   | Minimum order<br>(quantity) |
|-------------------------|-------------------|-------------------------|-----------------------------|
| Track-connecting Socket | Mounting track    | 50 cm (l) × 7.3 mm (t): | PFP-50N                     |
|                         |                   | 1 m (l) × 7.3 mm (t):   | PFP-100N                    |
|                         |                   | 1 m (l) × 16 mm (t):    | PFP-100N2                   |
| Track-connecting Socket | End plate *1      | PFP-M                   | 10                          |
|                         | Spacer            | PFP-S                   |                             |
| Back-connecting Socket  | Mounting plate *2 | P2R-P                   | 1                           |

\*1. When mounting DIN rail, please use End Plate (PFP-M).

\*2. Used to mount several P2R-05A and P2R-08A Connecting Sockets side by side.

## Specifications

### Coil Ratings

| Rated voltage |       | Rated current* |         | Coil resistance | Coil inductance (H) (ref. value) |             | Must operate voltage | Must release voltage | Max. voltage | Power consumption (approx.) |
|---------------|-------|----------------|---------|-----------------|----------------------------------|-------------|----------------------|----------------------|--------------|-----------------------------|
|               |       | 50 Hz          | 60 Hz   |                 | Armature OFF                     | Armature ON |                      |                      |              |                             |
| AC            | 24 V  | 43.5 mA        | 37.4 mA | 253 Ω           | 0.81                             | 1.55        | 80% max.             | 30% max.             | 110%         | 0.9 VA at 60 Hz             |
|               | 48 V  | 21.8 mA        | 18.8 mA | 1,040 Ω         | 3.12                             | 6.17        |                      |                      |              |                             |
|               | 110 V | 9.5 mA         | 8.2 mA  | 5,566 Ω         | 13.33                            | 26.83       |                      |                      |              |                             |
|               | 120 V | 8.6 mA         | 7.5 mA  | 7,286 Ω         | 16.13                            | 32.46       |                      |                      |              |                             |
|               | 230 V | 4.4 mA         | 3.8 mA  | 27,172 Ω        | 72.68                            | 143.90      |                      |                      |              |                             |
|               | 240 V | 4.2 mA         | 3.7 mA  | 27,800 Ω        | 90.58                            | 182.34      |                      |                      |              |                             |

| Rated voltage |      | Rated current* |       | Coil resistance | Coil inductance (H) (ref. value) |             | Must operate voltage | Must release voltage | Max. voltage | Power consumption (approx.) |
|---------------|------|----------------|-------|-----------------|----------------------------------|-------------|----------------------|----------------------|--------------|-----------------------------|
|               |      | 50 Hz          | 60 Hz |                 | Armature OFF                     | Armature ON |                      |                      |              |                             |
| DC            | 6 V  | 87.0 mA        |       | 69 Ω            | 0.25                             | 0.48        | 70% max.             | 15% min.             | 110%         | 0.53 W                      |
|               | 12 V | 43.2 mA        |       | 278 Ω           | 0.98                             | 2.35        |                      |                      |              |                             |
|               | 24 V | 21.6 mA        |       | 1,113 Ω         | 3.60                             | 8.25        |                      |                      |              |                             |
|               | 48 V | 11.4 mA        |       | 4,220 Ω         | 15.2                             | 29.82       |                      |                      |              |                             |

- Note:**
- The rated current and coil resistance are measured at a coil temperature of 23°C with tolerances of +15%/-20% for the AC rated current and ±10% for the DC coil resistance.
  - The AC coil resistance and inductance values are reference values only (at 60 Hz).
  - Operating characteristics were measured at a coil temperature of 23°C.
  - The maximum voltage is the maximum possible value of the voltage that can be applied to the relay coil. It is not the maximum voltage that can be applied continuously.

### Contact Ratings

| Number of poles                  | 1 pole                             |                                         | 2 poles                          |                                         |
|----------------------------------|------------------------------------|-----------------------------------------|----------------------------------|-----------------------------------------|
| Load                             | Resistive load (cosφ = 1)          | Inductive load (cosφ = 0.4; L/R = 7 ms) | Resistive load (cosφ = 1)        | Inductive load (cosφ = 0.4; L/R = 7 ms) |
| Rated load                       | 10 A at 250 VAC;<br>10 A at 30 VDC | 7.5 A at 250 VAC;<br>5 A at 30 VDC      | 5 A at 250 VAC;<br>5 A at 30 VDC | 2 A at 250 VAC; 3 A at 30 VDC           |
| Rated carry current              | 10 A                               |                                         | 5 A                              |                                         |
| Max. switching voltage           | 440 VAC, 125 VDC                   |                                         | 380 VAC, 125 VDC                 |                                         |
| Max. switching current           | 10 A                               |                                         | 5 A                              |                                         |
| Max. switching power             | 2,500 VA,<br>300 W                 | 1,875 VA,<br>150 W                      | 1,250 VA,<br>150 W               | 500 VA,<br>90 W                         |
| Failure rate (reference value) * | 100 mA at 5 VDC                    |                                         | 10 mA at 5 VDC                   |                                         |

**Note:** P level:  $\lambda_{60} = 0.1 \times 10^{-6}$ /operation

\* This value was measured at a switching frequency of 120 operations per minute.

## Characteristics

| Item                     | 1 pole                                                                                                                                                                                             | 2 poles                                                                                                                                                                                             |
|--------------------------|----------------------------------------------------------------------------------------------------------------------------------------------------------------------------------------------------|-----------------------------------------------------------------------------------------------------------------------------------------------------------------------------------------------------|
| Contact configuration    | SPDT                                                                                                                                                                                               |                                                                                                                                                                                                     |
| Contact structure        | Single                                                                                                                                                                                             |                                                                                                                                                                                                     |
| Contact resistance       | 100 mΩ max.                                                                                                                                                                                        |                                                                                                                                                                                                     |
| Operate (set) time       | 15 ms max.                                                                                                                                                                                         |                                                                                                                                                                                                     |
| Release (reset) time     | AC: 10 ms max.; DC: 5 ms max.<br>(w/built-in diode: 20 ms max.)                                                                                                                                    | AC: 15 ms max.; DC: 10 ms max.<br>(w/built-in diode: 20 ms max.)                                                                                                                                    |
| Max. operating frequency | Mechanical: 18,000 operations/hr<br>Electrical: 1,800 operations/hr (under rated load)                                                                                                             |                                                                                                                                                                                                     |
| Insulation resistance    | 1,000 MΩ min. (at 500 VDC)                                                                                                                                                                         |                                                                                                                                                                                                     |
| Dielectric strength *    | 5,000 VAC, 50/60 Hz for 1 min between coil and contacts;<br>1,000 VAC, 50/60 Hz for 1 min between contacts of same polarity                                                                        | 5,000 VAC, 50/60 Hz for 1 min between coil and contacts;<br>3,000 VAC, 50/60 Hz for 1 min between contacts of different polarity<br>1,000 VAC, 50/60 Hz for 1 min between contacts of same polarity |
| Vibration resistance     | Destruction: 10 to 55 to 10 Hz, 0.75 mm single amplitude (1.5 mm double amplitude)<br>Malfunction: 10 to 55 to 10 Hz, 0.75 mm single amplitude (1.5 mm double amplitude)                           |                                                                                                                                                                                                     |
| Shock resistance         | Destruction: 1,000 m/s <sup>2</sup><br>Malfunction: 200 m/s <sup>2</sup> when energized; 100 m/s <sup>2</sup> when not energized                                                                   |                                                                                                                                                                                                     |
| Endurance                | Mechanical: AC coil: 10,000,000 operations min.;<br>DC coil: 20,000,000 operations min. (at 18,000 operations/hr)<br>Electrical: 100,000 operations min. (at 1,800 operations/hr under rated load) |                                                                                                                                                                                                     |
| Ambient temperature      | Operating: -40°C to 70°C (with no icing or condensation)                                                                                                                                           |                                                                                                                                                                                                     |
| Ambient humidity         | Operating: 5% to 85%                                                                                                                                                                               |                                                                                                                                                                                                     |
| Weight                   | Approx. 20 g                                                                                                                                                                                       |                                                                                                                                                                                                     |

Note: Values in the above table are the initial values.

\*These values are relay only. Please refer to the "Products Related to Common Sockets and DIN Tracks Data Sheet" for connecting sockets.

## Approved Standards

### UL 508 (File No. E41643)

| Model       | Contact form | Coil ratings                 | Contact ratings                                         | Operations            |
|-------------|--------------|------------------------------|---------------------------------------------------------|-----------------------|
| G2R-1-S (S) | SPDT         | 5 to 110 VDC<br>6 to 240 VAC | 10 A, 30 VDC (resistive)<br>10 A, 250 VAC (general use) | 100 × 10 <sup>3</sup> |
|             |              |                              | TV-3 (NO contact only)                                  | 25 × 10 <sup>3</sup>  |
| G2R-2-S (S) | DPDT         | 5 to 110 VDC<br>6 to 240 VAC | 5 A, 30 VDC (resistive)<br>5 A, 250 VAC (general use)   | 100 × 10 <sup>3</sup> |
|             |              |                              | TV-3 (NO contact only)                                  | 25 × 10 <sup>3</sup>  |

### CSA 22.2 No.0, No.14

#### (File No. LR31928)

| Model       | Contact form | Coil ratings                 | Contact ratings                                         | Operations            |
|-------------|--------------|------------------------------|---------------------------------------------------------|-----------------------|
| G2R-1-S (S) | SPDT         | 5 to 110 VDC<br>6 to 240 VAC | 10 A, 30 VDC (resistive)<br>10 A, 250 VAC (general use) | 100 × 10 <sup>3</sup> |
|             |              |                              | TV-3 (NO contact only)                                  | 25 × 10 <sup>3</sup>  |
| G2R-2-S (S) | DPDT         | 5 to 110 VDC<br>6 to 240 VAC | 5 A, 30 VDC (resistive)<br>5 A, 250 VAC (general use)   | 100 × 10 <sup>3</sup> |
|             |              |                              | TV-3 (NO contact only)                                  | 25 × 10 <sup>3</sup>  |

### IEC/VDE (Certificate No. 40015012 EN 61810-1)

| Contact form | Coil ratings                                       | Contact ratings                                                                | Operations            |
|--------------|----------------------------------------------------|--------------------------------------------------------------------------------|-----------------------|
| 1 pole       | 6, 12, 24, 48 VDC<br>24, 110, 120, 230,<br>240 VAC | 5 A, 440 VAC (cosφ = 1.0)<br>10 A, 250 VAC (cosφ = 1.0)<br>10 A, 30 VDC (0 ms) | 100 × 10 <sup>3</sup> |
| 2 poles      | 6, 12, 24, 48 VDC<br>24, 110, 120, 230,<br>240 VAC | 5 A, 250 VAC (cosφ = 1.0)<br>5 A, 30 VDC (0 ms)                                | 100 × 10 <sup>3</sup> |

### LR

| Number of poles | Coil ratings                 | Contact ratings                                                                                          | Operations            |
|-----------------|------------------------------|----------------------------------------------------------------------------------------------------------|-----------------------|
| 1 pole          | 5 to 110 VDC<br>6 to 240 VDC | 10 A, 250 VAC (general use)<br>7.5 A, 250 VAC (PF0.4)<br>10 A, 30 VDC (resistive)<br>5A, 30VDC (L/R=7ms) | 100 × 10 <sup>3</sup> |
| 2 poles         | 5 to 110 VDC<br>6 to 240 VDC | 5 A, 250 VAC (general use)<br>2 A, 250 VAC (PF0.4)<br>5 A, 30 VDC (resistive)<br>3A, 30VDC (L/R=7ms)     | 100 × 10 <sup>3</sup> |



# Engineering Data

## Maximum Switching Power

G2R-1-S (S)

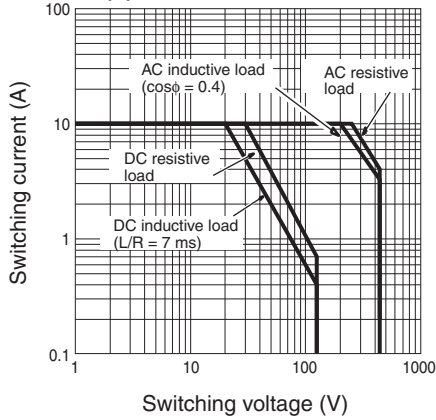

G2R-2-S (S)

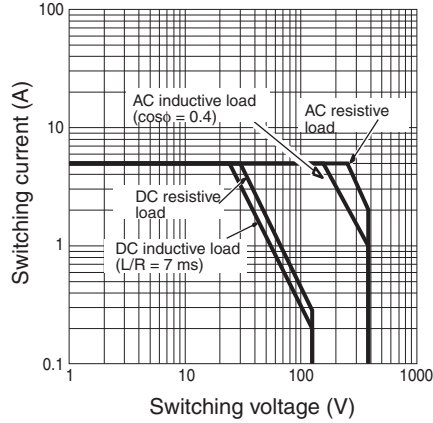

## Endurance

G2R-1-S (S)

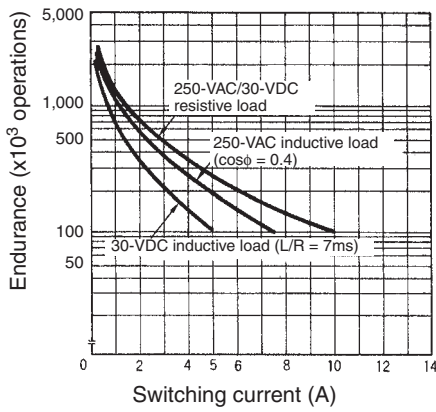

G2R-2-S (S)

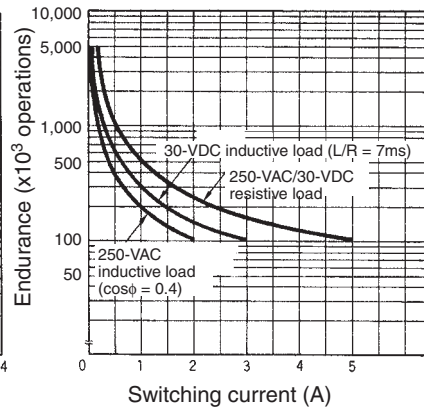

## Ambient Temperature vs Maximum Coil Voltage

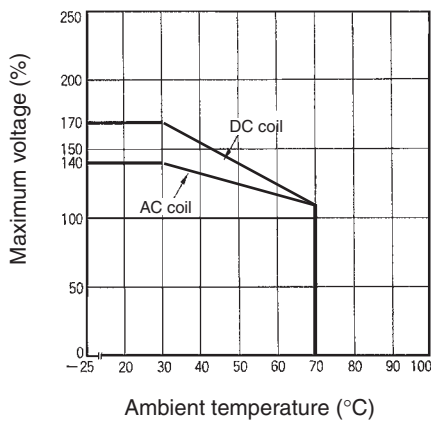

# Dimensions

Note: All units are in millimeters unless otherwise indicated.

## SPDT Relays

G2R-1-S (S), G2R-1-SN (S), G2R-1-SNI (S)  
 G2R-1-SD (S), G2R-1-SND (S), G2R-1-SNDI (S)

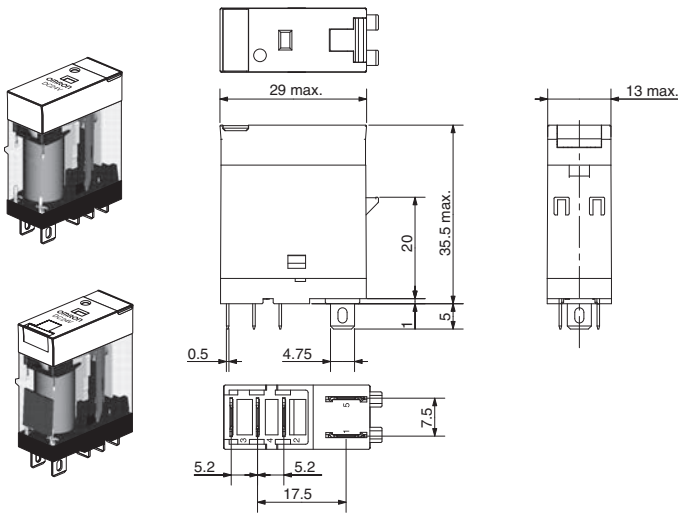

## Terminal Arrangement/Internal Connections (Bottom View)

G2R-1-S (S)

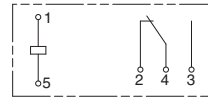

G2R-1-SD (S) (DC)

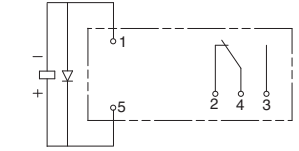

G2R-1-SN (S), G2R-1-SNI (S) (AC)

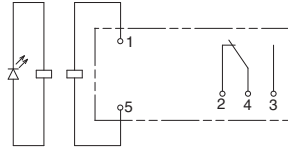

G2R-1-SN (S), G2R-1-SNI (S) (DC)

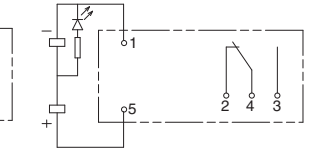

G2R-1-SND (S), G2R-1-SNDI (S) (DC)

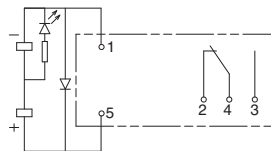

## DPDT Relays

G2R-2-S (S), G2R-2-SN (S), G2R-2-SNI (S)  
 G2R-2-SD (S), G2R-2-SND (S), G2R-2-SNDI (S)

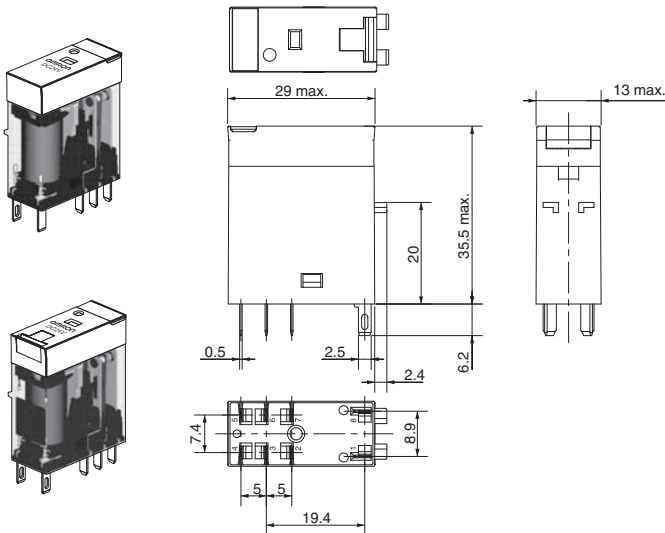

## Terminal Arrangement/Internal Connections (Bottom View)

G2R-2-S (S)

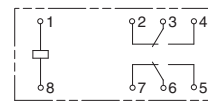

G2R-2-SD (S) (DC)

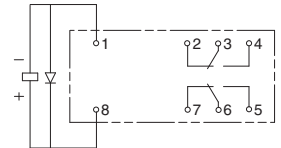

G2R-2-SN (S), G2R-2-SNI (S) (AC)

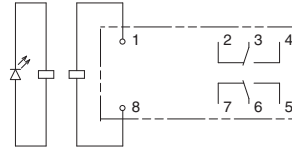

G2R-2-SN (S), G2R-2-SNI (S) (DC)

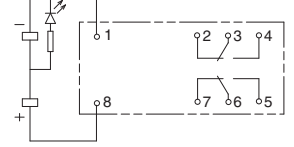

G2R-2-SND (S), G2R-2-SNDI (S) (DC)

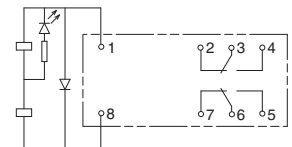

## Accessories (Order Separately)

### Socket Characteristics

| Model        | Continuous carry current | Dielectric strength                                                  | Insulation resistance* | Remarks |
|--------------|--------------------------|----------------------------------------------------------------------|------------------------|---------|
| P2RF-05-PU   | 10 A                     | Between contact terminals of same polarity: 1,000 VAC for 1 min      | 1,000 MΩ min.          |         |
|              |                          | Between coil and contact terminals: 4,000 VAC for 1 min              |                        |         |
| P2RF-08-PU   | 6 A                      | Between contact terminals of different polarity: 3,000 VAC for 1 min | 1,000 MΩ min.          |         |
|              |                          | Between contact terminals of same polarity: 1,000 VAC for 1 min      |                        |         |
|              |                          | Between coil and contact terminals: 4,000 VAC for 1 min              |                        |         |
| P2RFZ-05(-E) | 10 A                     | Between contact terminals of same polarity: 1,000 VAC for 1 min      | 1,000 MΩ min.          |         |
|              |                          | Between coil and contact terminals: 4,000 VAC for 1 min              |                        |         |
| P2RFZ-08(-E) | 6 A                      | Between contact terminals of different polarity: 3,000 VAC for 1 min | 1,000 MΩ min.          |         |
|              |                          | Between contact terminals of same polarity: 1,000 VAC for 1 min      |                        |         |
|              |                          | Between coil and contact terminals: 4,000 VAC for 1 min              |                        |         |
| P2RF-05      | 10 A                     | Between contact terminals of same polarity: 1,000 VAC for 1 min      | 1,000 MΩ min.          |         |
|              |                          | Between coil and contact terminals: 4,000 VAC for 1 min              |                        |         |
| P2RF-08      | 5 A                      | Between contact terminals of different polarity: 3,000 VAC for 1 min | 1,000 MΩ min.          |         |
|              |                          | Between contact terminals of same polarity: 1,000 VAC for 1 min      |                        |         |
|              |                          | Between coil and contact terminals: 4,000 VAC for 1 min              |                        |         |
| P2R-05P      | 10 A                     | Between contact terminals of same polarity: 1,000 VAC for 1 min      | 1,000 MΩ min.          |         |
|              |                          | Between coil and contact terminals: 4,000 VAC for 1 min              |                        |         |
| P2R-08P      | 5 A                      | Between contact terminals of different polarity: 3,000 VAC for 1 min | 1,000 MΩ min.          |         |
|              |                          | Between contact terminals of same polarity: 1,000 VAC for 1 min      |                        |         |
|              |                          | Between coil and contact terminals: 4,000 VAC for 1 min              |                        |         |
| P2R-057P     | 10 A                     | Between contact terminals of same polarity: 1,000 VAC for 1 min      | 1,000 MΩ min.          |         |
|              |                          | Between coil and contact terminals: 5,000 VAC for 1 min              |                        |         |
| P2R-087P     | 5 A                      | Between contact terminals of different polarity: 3,000 VAC for 1 min | 1,000 MΩ min.          |         |
|              |                          | Between contact terminals of same polarity: 1,000 VAC for 1 min      |                        |         |
|              |                          | Between coil and contact terminals: 5,000 VAC for 1 min              |                        |         |
| P2R-05A      | 10 A                     | Between contact terminals of same polarity: 1,000 VAC for 1 min      | 1,000 MΩ min.          |         |
|              |                          | Between ground terminals: 1,500 VAC for 1 min                        |                        |         |
|              |                          | Between coil and contact terminals: 4,000 VAC for 1 min              |                        |         |
| P2R-08A      | 5 A                      | Between contact terminals of different polarity: 3,000 VAC for 1 min | 1,000 MΩ min.          |         |
|              |                          | Between contact terminals of same polarity: 1,000 VAC for 1 min      |                        |         |
|              |                          | Between ground terminals: 1,500 VAC for 1 min                        |                        |         |
|              |                          | Between coil and contact terminals: 4,000 VAC for 1 min              |                        |         |

\* The insulation resistance was measured with a 500-VDC insulation resistance meter at the same places as those used for measuring the dielectric strength.

Track/Surface Mounting Sockets

P2RF-05-PU

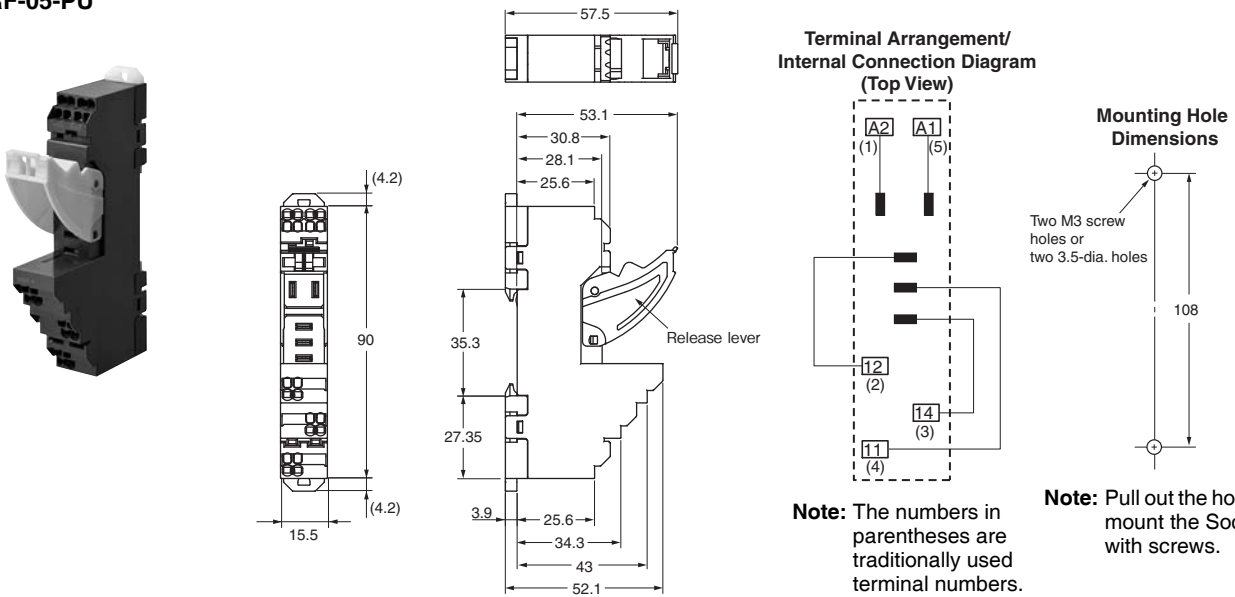

P2RF-08-PU

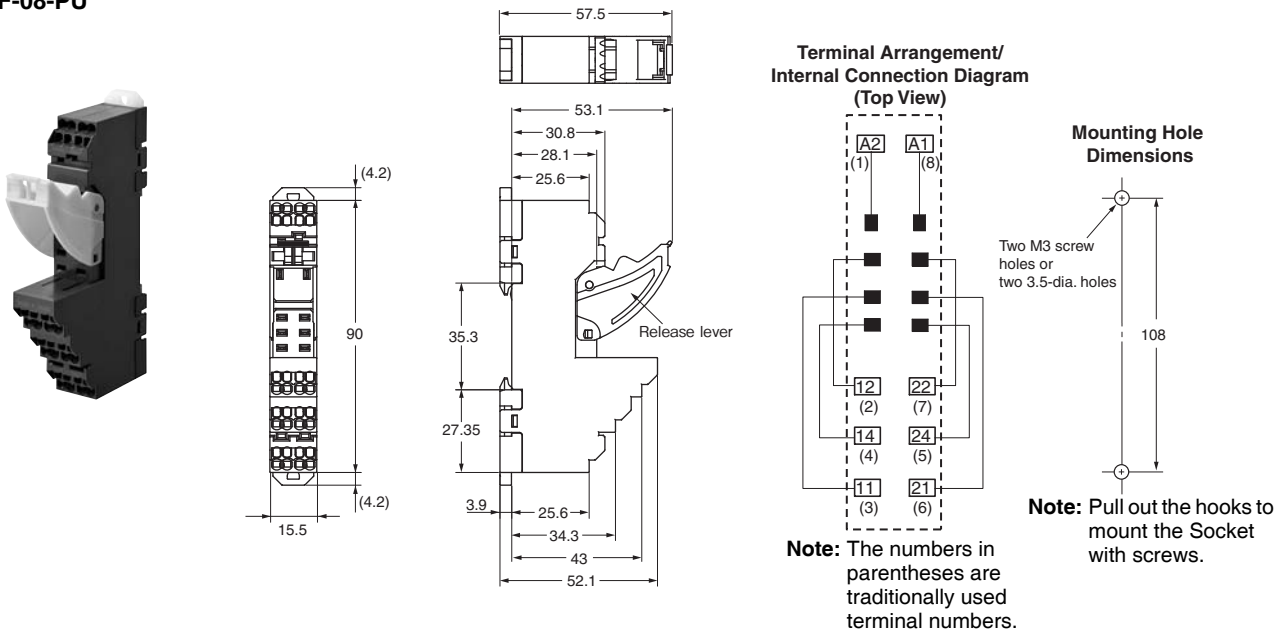

Accessories for P2RF-□-PU

Short Bars

PYDN-7.75-□□ (7.75 mm)

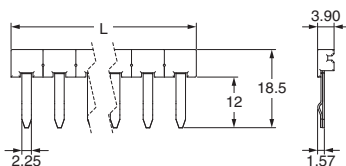

PYDN-15.5-080□ (15.5 mm)

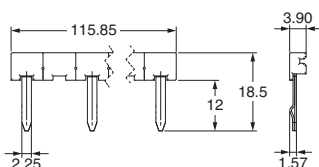

| Application                    | Pitch   | No. of poles | L (Length) | Colors                            | Model *        | Maximum carry current |
|--------------------------------|---------|--------------|------------|-----------------------------------|----------------|-----------------------|
| For Contact terminals (common) | 7.75 mm | 2            | 15.1       | Red (R)<br>Blue (S)<br>Yellow (Y) | PYDN-7.75-020□ | 20 A                  |
|                                |         | 3            | 22.85      |                                   | PYDN-7.75-030□ |                       |
|                                |         | 4            | 30.6       |                                   | PYDN-7.75-040□ |                       |
|                                |         | 20           | 154.6      |                                   | PYDN-7.75-200□ |                       |
| For Coil terminals             | 15.5 mm | 8            | 115.85     |                                   | PYDN-15.5-080□ |                       |

\* Replace the box (□) in the model number with the code for the covering color.

- Note:**
1. Use the Short Bars for crossover wiring within one Socket or between Sockets.
  2. When using short bar to coil terminals of PYF-□□-PU, make sure to use PYDN-31.0-080□ (31 mm).  
When using short bar to coil terminals of P2RF-□□-PU, make sure to use PYDN-15.5-080□ (15.5 mm).

P2RFZ-05-E

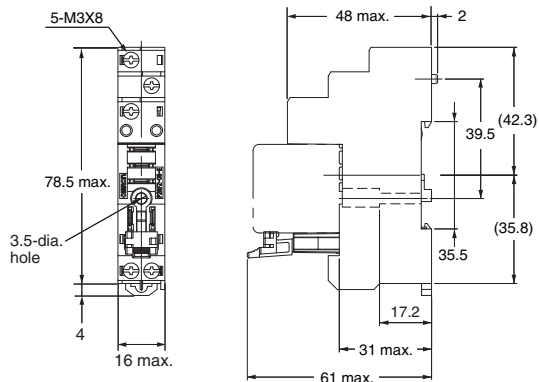

Terminal Arrangement/  
Internal Connection Diagram  
(Top View)

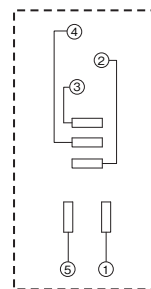

Mounting Hole  
Dimensions

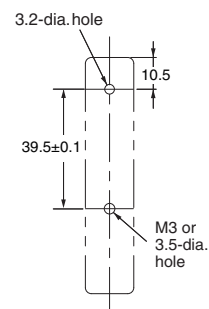

P2RFZ-08-E

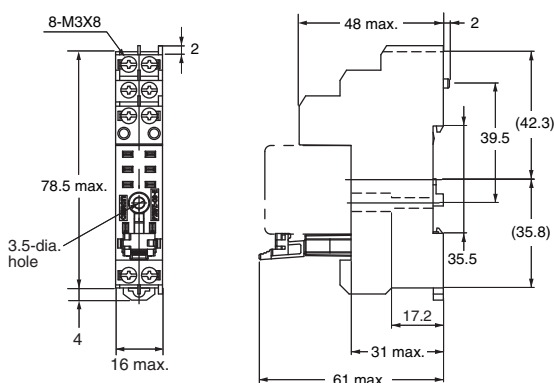

Terminal Arrangement/  
Internal Connection Diagram  
(Top View)

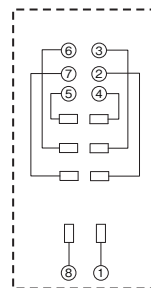

Mounting Hole  
Dimensions

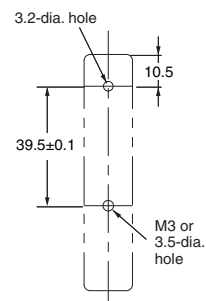

P2RFZ-05

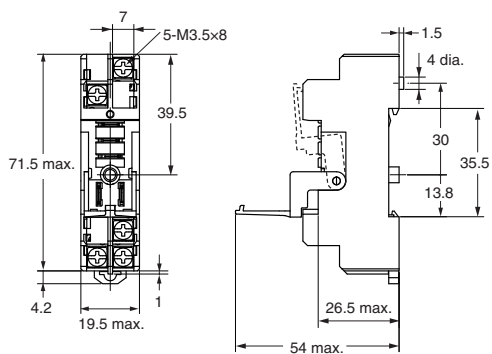

Terminal Arrangement/  
Internal Connection Diagram  
(Top View)

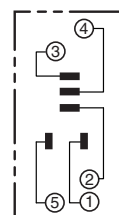

Mounting Hole  
Dimensions

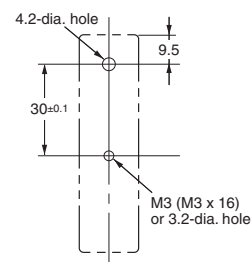

P2RFZ-08

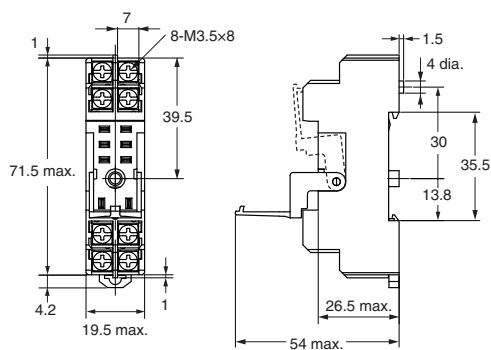

Terminal Arrangement/  
Internal Connection Diagram  
(Top View)

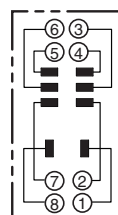

Mounting Hole  
Dimensions

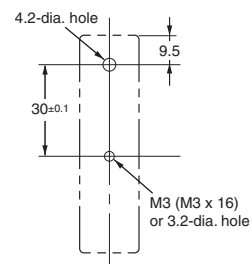

**P2RF-05**

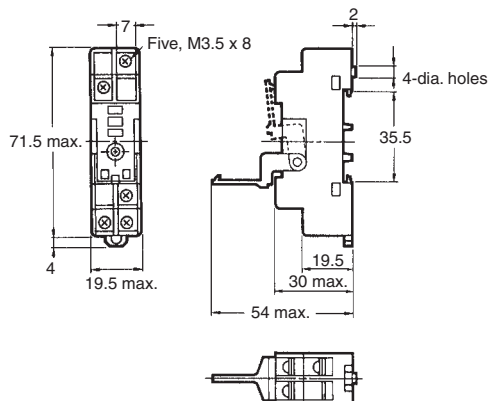
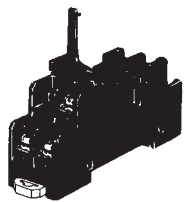

**Terminal Arrangement (Top View)**

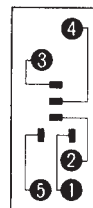

**Mounting Holes (for Surface Mounting)**

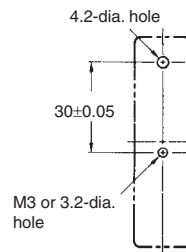

**P2RF-08**

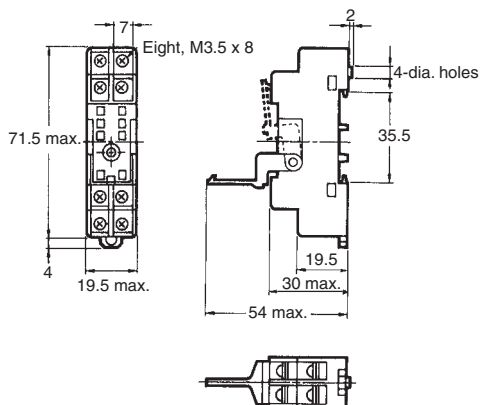
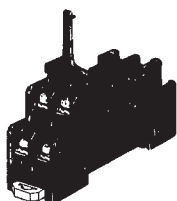

**Terminal Arrangement (Top View)**

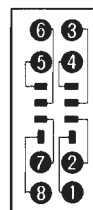

**Mounting Holes (for Surface Mounting)**

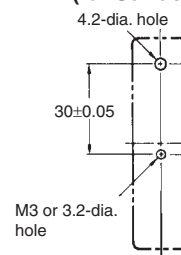

Mounting Height of Relay with Track/Surface Mounting Sockets

P2RF-05-PU

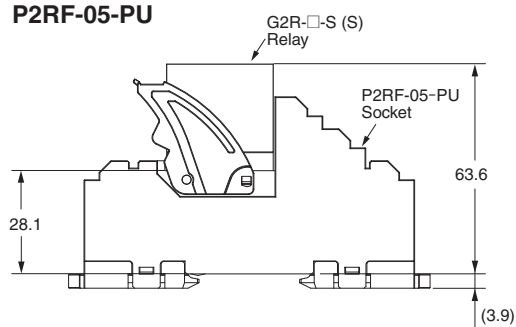

P2RF-08-PU

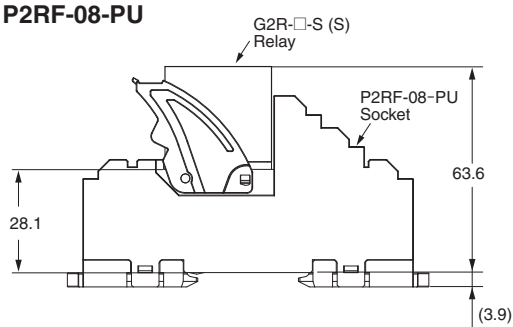

P2RFZ-□

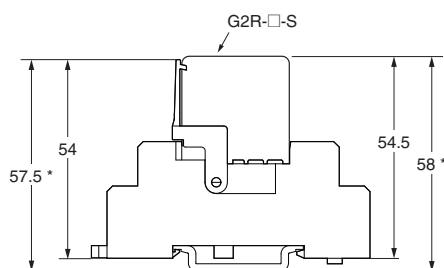

P2RFZ-□-E

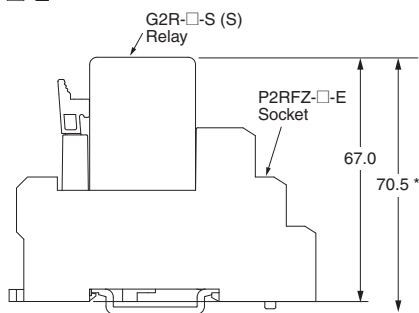

P2RF-□

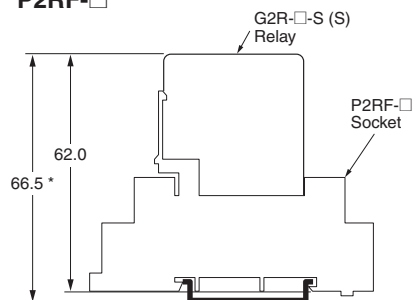

\* These are values when using the DIN track PFP-□N.  
Heights become higher by approximately 9 mm when using PFP-□N2.

Back-connecting Sockets

P2R-05P (1-pole)

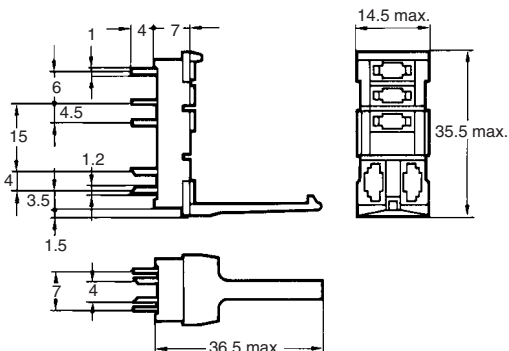
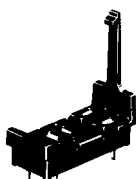

Terminal Arrangement (Bottom View)

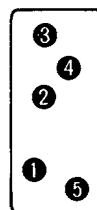

Mounting Holes

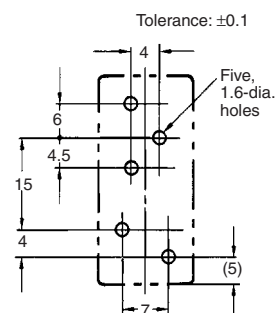

P2R-08P (2-pole)

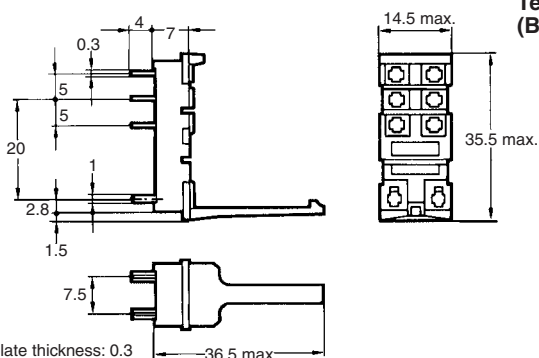
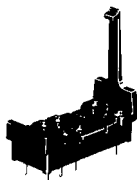

Terminal Arrangement (Bottom View)

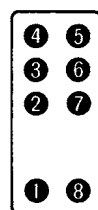

Mounting Holes

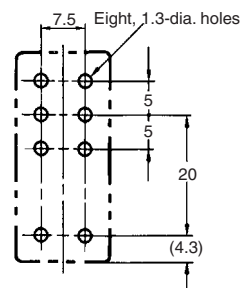

P2R-05A (1-pole)

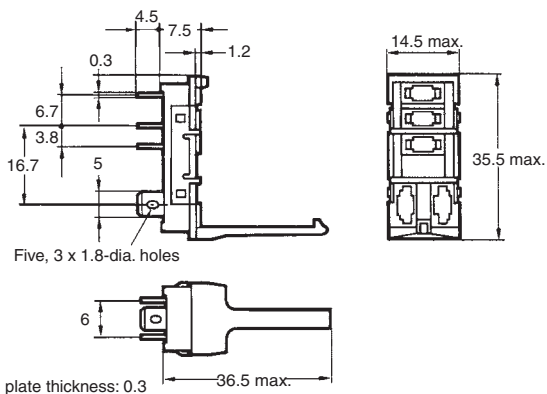
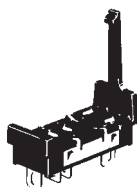

Terminal Arrangement (Bottom View)



Panel Cutout

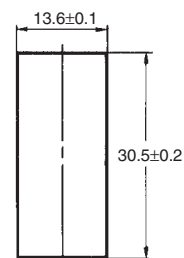

Recommended thickness of the panel is 1.6 to 2.0 mm

P2R-08A (2-pole)

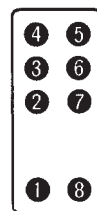
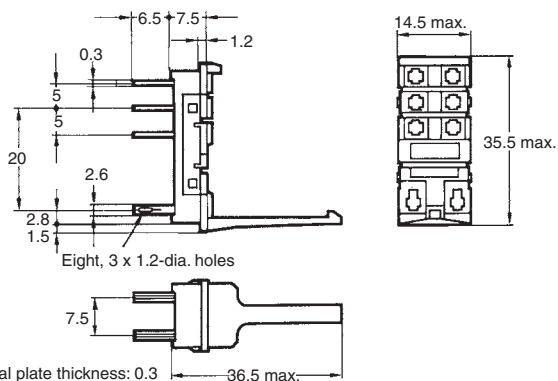
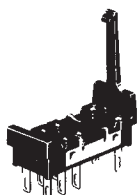



**P2R-057P (1-pole)**

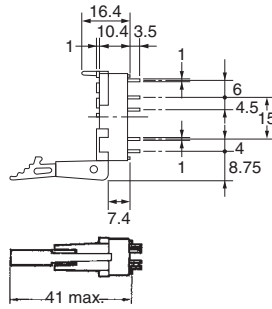
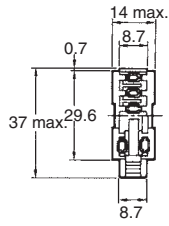
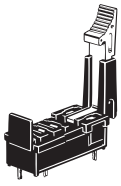

**Terminal Arrangement (Bottom View)**



**Mounting Holes**

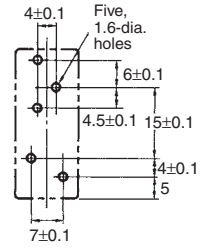

**P2R-087P (2-pole)**

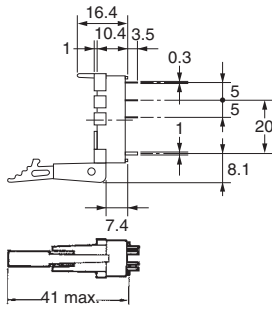
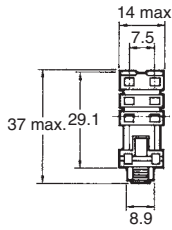
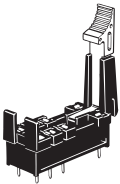

**Terminal Arrangement (Bottom View)**

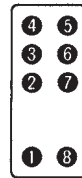

**Mounting Holes**

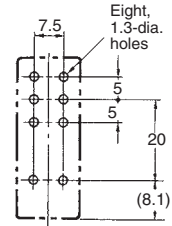

**Mounting Height of Relay with Back-connecting Sockets**

**P2R-□P**

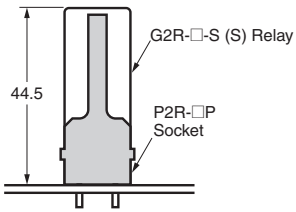

**P2R-□A**

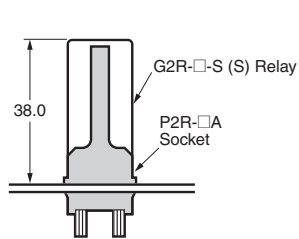

**P2R-□7P**

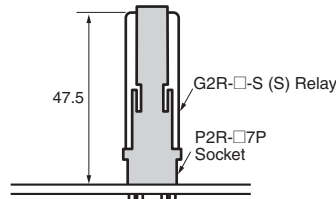

## Mounting Tracks

### PFP-100N, PFP-50N

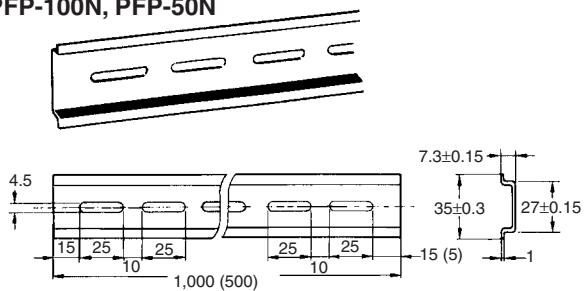

### PFP-100N2

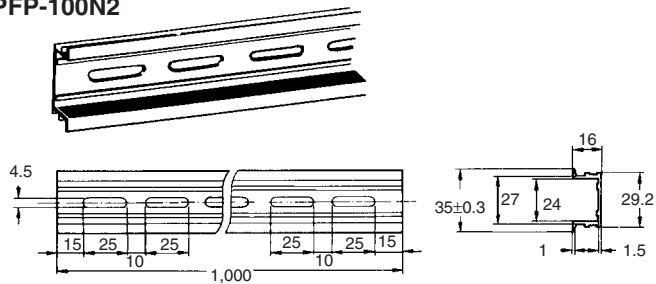

It is recommended to use a panel 1.6 to 2.0 mm thick.

## End Plate

### PFP-M

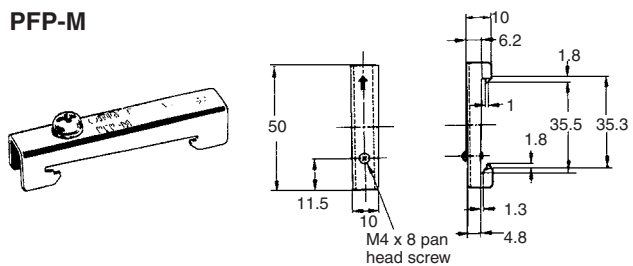

## Spacer

### PFP-S

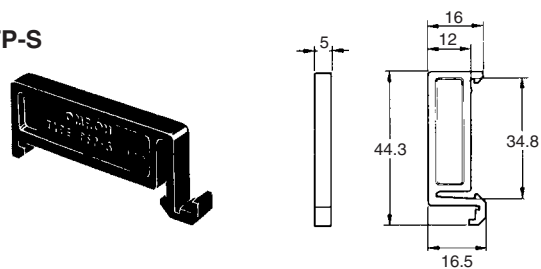

## Mounting Plate

### P2R-P

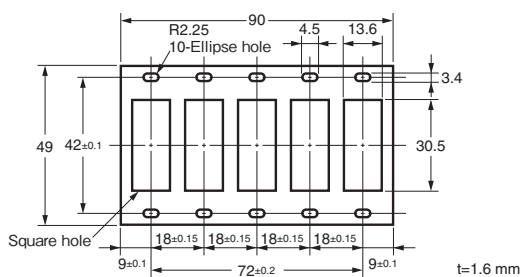

## Safety Precautions

Be sure to read the *Common Precautions for All Relay* in the website at the following URL:  
<http://www.ia.omron.com/>.

Refer to *Products Related to Common Sockets and DIN Tracks* for precautions on the applicable Sockets.  
 Refer to *PYF-□□-PU/P2RF-□□-PU* for precautions on Push-In Plus Terminal Block Sockets.

### Warning Indications

|                                                                                                  |                                                                                                                                                |
|--------------------------------------------------------------------------------------------------|------------------------------------------------------------------------------------------------------------------------------------------------|
|  <b>CAUTION</b> | Indicates a potentially hazardous situation which, if not avoided, may result in minor or moderate injury or in property damage.               |
| <b>Precautions for Correct Use</b>                                                               | Supplementary comments on what to do or avoid doing to prevent failure to operate, malfunction, or undesirable effects on product performance. |

### Cation

- Do not use the test button for any purpose other than testing. Be sure not to touch the test button accidentally as this will turn the contacts ON. Before using the test button, confirm that circuits, the load, and any other connected item will operate safely.
- Check that the test button is released before turning ON relay circuits.
- If the test button is pulled out too forcefully, it may bypass the momentary testing position and go straight into the locked position.
- Use an insulated tool when you operate the test button.

### Precautions for Correct Use

#### About the Built-in Diodes

The diodes that are built into the Relays are designed to absorb reverse voltage from the Relay's coil. If a large surge in voltage is applied to the diode from an external source, the element will be destroyed.

If there is the possibility of large voltage surges that could be applied to the elements from an external source, take any necessary surge absorption measures.

#### Latching Levers

- Turn OFF the power supply when operating the latching lever. After you use the latching lever always return it to its original state.
- Do not use the latching lever as a switch.
- The latching lever can be used for 100 operations minimum.

#### Relay Replacement

To replace the Relay, turn OFF the power supply to the load and Relay coil sides to prevent unintended operation and possible electrical shock.

#### Coil tape color

Pink tape is used for the AC coil type and blue tape is used for the DC coil type, making it easy to distinguish AC and DC.

#### Screw terminal socket

- Use the following tightening torque for screws during wiring.

| Model                                              | Tightening torque                             |
|----------------------------------------------------|-----------------------------------------------|
| P2RF-05<br>P2RF-08                                 | 0.78 to 1.18 N·m                              |
| P2RFZ-05-E<br>P2RFZ-08-E<br>P2RF-05-E<br>P2RF-08-E | 0.59 to 0.88 N·m<br>*Use a No. 1 screwdriver. |

- Use the following wire diameters as a guide for wiring. (Select the appropriate wire diameter for the current used.)

| Model                                              | Recommended wire diameter (mm <sup>2</sup> ) |                                             |
|----------------------------------------------------|----------------------------------------------|---------------------------------------------|
| P2RF-05<br>P2RF-08                                 | Stranded wire                                | 0.75 to 2.5 mm <sup>2</sup><br>AWG 18 to 14 |
|                                                    | Solid wire                                   | 0.75 to 2.0 mm <sup>2</sup><br>AWG 18 to 14 |
| P2RFZ-05-E<br>P2RFZ-08-E<br>P2RF-05-E<br>P2RF-08-E | Stranded wire                                | 0.75 to 2.5 mm <sup>2</sup><br>AWG 18 to 14 |
|                                                    | Solid wire                                   | 0.75 to 1.5 mm <sup>2</sup><br>AWG 18 to 16 |

#### Using a short-circuit bar

- Use the short-circuit bar that is suitable for the socket you are using and the location of use.
- Note that the P2DN short-circuit bar for the P2RFZ-E Socket has both a short-circuit bar for shorting coil terminals and a short-circuit bar for shorting contact COM terminals.
- The short-circuit bar can be cut to match any number of poles. Cut with a tool as appropriate for the number of relays and sockets. When using a cut short-circuit bar, take care to avoid injuring yourself on the cut surface.
- When cutting with a tool, insert the tool from the plastic part and cut along the slot in the plastic part between terminals. If you cut a part other than the slot in the plastic part between terminals, it may not be possible to attach the insulating cap.

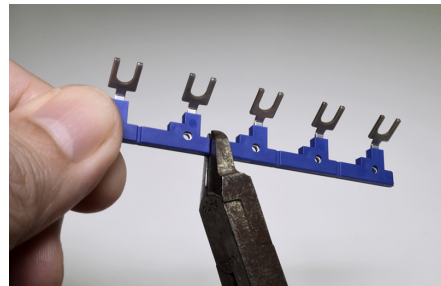

- When using a cut short-circuit bar (P2DN), always use the provided cap to protect the charger part.

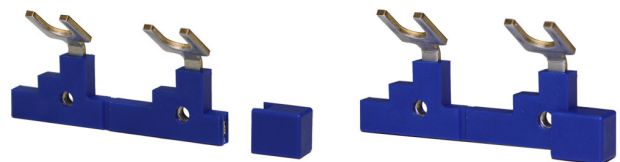

- Use the short-circuit bar to short-circuit two or more coil terminals, or two or more contact COM terminals.
- Do not use a deformed short-circuit bar. Risk of failure, malfunctioning, or deterioration of characteristics.
- In socket terminals, insert the short-circuit bar in the correct orientation all the way into all terminals, and then secure with screws.
- Install the short-circuit bar before wiring.

## Equivalent Labels from Other Companies and Recommended Label Printers

Use the following label printer.

The following table gives the manufacturer's model number as of March 2017.

| Manufacturer  | Omron        | Phoenix Contact                                                              | Weidmuller                                                            | Cembre              |
|---------------|--------------|------------------------------------------------------------------------------|-----------------------------------------------------------------------|---------------------|
| Label         | XW5Z-P4.0LB1 | UCT-TM6                                                                      | MF 10/6                                                               | MG-CPM-04<br>41391  |
|               | XW5Z-P2.5LB2 | UCT-TMF5                                                                     | ---                                                                   | ---                 |
| Label printer | --- *        | BLUEMARK<br>CLED,<br>THERMOMA<br>RK CARD<br>SET PLUS,<br>THERMOMA<br>RK CARD | PrintJet<br>ADVANCED,<br>Plotter MCP<br>Plus,<br>Plotter MCP<br>Basic | Markingenius<br>MG3 |

\* When using a printing tool, use a Phoenix Contact label printer.

**Note:** Ask the label manufacturer or printer manufacturer for details.

## Terms and Conditions Agreement

### Read and understand this catalog.

Please read and understand this catalog before purchasing the products. Please consult your OMRON representative if you have any questions or comments.

### Warranties.

(a) Exclusive Warranty. Omron's exclusive warranty is that the Products will be free from defects in materials and workmanship for a period of twelve months from the date of sale by Omron (or such other period expressed in writing by Omron). Omron disclaims all other warranties, express or implied.

(b) Limitations. OMRON MAKES NO WARRANTY OR REPRESENTATION, EXPRESS OR IMPLIED, ABOUT NON-INFRINGEMENT, MERCHANTABILITY OR FITNESS FOR A PARTICULAR PURPOSE OF THE PRODUCTS. BUYER ACKNOWLEDGES THAT IT ALONE HAS DETERMINED THAT THE PRODUCTS WILL SUITABLY MEET THE REQUIREMENTS OF THEIR INTENDED USE.

Omron further disclaims all warranties and responsibility of any type for claims or expenses based on infringement by the Products or otherwise of any intellectual property right. (c) Buyer Remedy. Omron's sole obligation hereunder shall be, at Omron's election, to (i) replace (in the form originally shipped with Buyer responsible for labor charges for removal or replacement thereof) the non-complying Product, (ii) repair the non-complying Product, or (iii) repay or credit Buyer an amount equal to the purchase price of the non-complying Product; provided that in no event shall Omron be responsible for warranty, repair, indemnity or any other claims or expenses regarding the Products unless Omron's analysis confirms that the Products were properly handled, stored, installed and maintained and not subject to contamination, abuse, misuse or inappropriate modification. Return of any Products by Buyer must be approved in writing by Omron before shipment. Omron Companies shall not be liable for the suitability or unsuitability or the results from the use of Products in combination with any electrical or electronic components, circuits, system assemblies or any other materials or substances or environments. Any advice, recommendations or information given orally or in writing, are not to be construed as an amendment or addition to the above warranty.

See <http://www.omron.com/global/> or contact your Omron representative for published information.

### Limitation on Liability; Etc.

OMRON COMPANIES SHALL NOT BE LIABLE FOR SPECIAL, INDIRECT, INCIDENTAL, OR CONSEQUENTIAL DAMAGES, LOSS OF PROFITS OR PRODUCTION OR COMMERCIAL LOSS IN ANY WAY CONNECTED WITH THE PRODUCTS, WHETHER SUCH CLAIM IS BASED IN CONTRACT, WARRANTY, NEGLIGENCE OR STRICT LIABILITY.

Further, in no event shall liability of Omron Companies exceed the individual price of the Product on which liability is asserted.

### Suitability of Use.

Omron Companies shall not be responsible for conformity with any standards, codes or regulations which apply to the combination of the Product in the Buyer's application or use of the Product. At Buyer's request, Omron will provide applicable third party certification documents identifying ratings and limitations of use which apply to the Product. This information by itself is not sufficient for a complete determination of the suitability of the Product in combination with the end product, machine, system, or other application or use. Buyer shall be solely responsible for determining appropriateness of the particular Product with respect to Buyer's application, product or system. Buyer shall take application responsibility in all cases.

NEVER USE THE PRODUCT FOR AN APPLICATION INVOLVING SERIOUS RISK TO LIFE OR PROPERTY OR IN LARGE QUANTITIES WITHOUT ENSURING THAT THE SYSTEM AS A WHOLE HAS BEEN DESIGNED TO ADDRESS THE RISKS, AND THAT THE OMRON PRODUCT(S) IS PROPERLY RATED AND INSTALLED FOR THE INTENDED USE WITHIN THE OVERALL EQUIPMENT OR SYSTEM.

### Programmable Products.

Omron Companies shall not be responsible for the user's programming of a programmable Product, or any consequence thereof.

### Performance Data.

Data presented in Omron Company websites, catalogs and other materials is provided as a guide for the user in determining suitability and does not constitute a warranty. It may represent the result of Omron's test conditions, and the user must correlate it to actual application requirements. Actual performance is subject to the Omron's Warranty and Limitations of Liability.

### Change in Specifications.

Product specifications and accessories may be changed at any time based on improvements and other reasons. It is our practice to change part numbers when published ratings or features are changed, or when significant construction changes are made. However, some specifications of the Product may be changed without any notice. When in doubt, special part numbers may be assigned to fix or establish key specifications for your application. Please consult with your Omron's representative at any time to confirm actual specifications of purchased Product.

### Errors and Omissions.

Information presented by Omron Companies has been checked and is believed to be accurate; however, no responsibility is assumed for clerical, typographical or proofreading errors or omissions.

## X-ON Electronics

Largest Supplier of Electrical and Electronic Components

*Click to view similar products for [Industrial Relays](#) category:*

*Click to view products by [Omron](#) manufacturer:*

Other Similar products are found below :

[6-1617801-8](#) [6-1618107-9](#) [7-1618273-3](#) [EV250-4A-02](#) [EV250-6A-01](#) [FCA-125-CX8](#) [FCA-325-159](#) [FCA-410-138](#) [8000-S3121](#) [8-1618273-6](#)  
[8-1618393-1](#) [GCA63A220VAC60HZ](#) [GCA63A277VAC60HZ](#) [GCA63A600VAC60HZ](#) [1-1672275-3](#) [1-1833005-4](#) [H-16/S1](#) [A711Z](#) [H-8C](#)  
[H-8/S11](#) [H-8/S68](#) [ACC530U20](#) [ACC730U30](#) [RF303ZM4-12](#) [DH18DA](#) [1423675-8](#) [AR4-15F13-C01](#) [AR7-41F11](#) [AVR907](#) [15732A200](#)  
[B07B032AC1-0329](#) [B329](#) [B490A](#) [1618279-1](#) [BHR124Y](#) [1810DDB-SX](#) [N417](#) [P30C42A12D1-120](#) [2-1617748-6](#) [2-1618375-1](#) [2-1618396-6](#)  
[2-1618398-1](#) [JMAPD-5XL](#) [JMGACD-5M](#) [JMGSC-5LW](#) [JMGSCD-5L](#) [PBO-18A1218](#) [PBO-40A3040](#) [K8DSPH1200480VAC](#) [KA-3C-12A](#)