

# General-purpose Relay G2R-□-S (S)

CSM\_G2R-\_-S\_(S)\_DS\_E\_1\_7

## Slim and Space-saving Power Plug-in Relay

- Reduces wiring work by 60% when combined with the P2RF-□-PU Push-In Plus Socket (according to actual OMRON measurements).
- Lockable test button models available.
- Built-in mechanical operation indicator.
- Provided with nameplate.
- AC type is equipped with a coil-disconnection self-diagnostic function (LED type).
- High switching power (1-pole: 10 A).

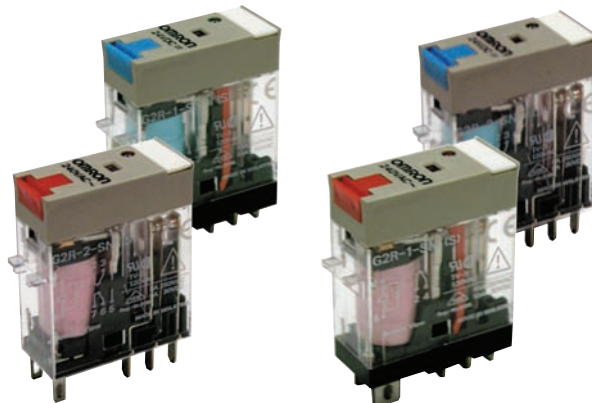

For the most recent information on models that have been certified for safety standards, refer to your OMRON website.

## Model Number Structure

### Model Number Legend

G2R - □ - S □ □ (S)  
1 2 3 4 5

#### 1. Number of Poles

- 1: 1 pole
- 2: 2 poles

#### 2. Terminals

- S: Plug-in

#### 3. Classification

- Blank: General-purpose
- N: LED indicator
- D: Diode
- ND: LED indicator and diode
- NI: LED indicator with test button
- NDI: LED indicator and diode with test button

#### 4. Rated Coil Voltage

#### 5. Mechanical operation indicator and Nameplate

- (S): Models with mechanical operation indicator and Nameplate

**Note:** Contact your OMRON representative for Relays with gold-plated contacts.

## Ordering Information

When your order, specify the rated voltage.

### List of Models

Classification	Coil ratings	Contact form	
		SPDT	DPDT
General-purpose	AC 24, 48, 110, 120, 230, 240 DC 6, 12, 24, 48	G2R-1-S (S)	G2R-2-S (S)
LED indicator		G2R-1-SN (S)	G2R-2-SN (S)
LED indicator with test button		G2R-1-SNI (S)	G2R-2-SNI (S)
Diode	DC 6, 12, 24, 48	G2R-1-SD (S)	G2R-2-SD (S)
LED indicator and diode		G2R-1-SND (S)	G2R-2-SND (S)
LED indicator and diode with test button		G2R-1-SNDI (S)	G2R-2-SNDI (S)

**Note:** 1. The standard models are compliant with UL/CSA and VDE standards. Also, an EC compliance declaration has been made for combinations with the P2RF-□-E, P2RF-□-S and P2RF-□-PU. The Relays bear the CE Marking.

2. Refer to *Connecting Sockets*, below, for applicable Socket models.

3. When ordering, add the rated coil voltage and "(S)" to the model number. Rated coil voltages are given in the coil ratings table.

Example: G2R-1-S 12 VDC (S)

Rated coil voltage

## Accessories (Order Separately)

### Connecting Sockets

Applicable Relay model		Track/surface-mounting Socket		Back-mounting Socket	
		Push-In Plus Terminal Blocks	Screw terminals *	PCB terminals	Solder terminals
		Model	Models	Models	Model
1 pole	G2R-1-S (S)	P2RF-05-PU	P2RFZ-05-E P2RF-05 P2RF-05-E	P2R-05P P2R-057P	P2R-05A
2 poles	G2R-2-S (S)	P2RF-08-PU	P2RFZ-08-E P2RF-08 P2RF-08-E	P2R-08P P2R-087P	P2R-08A

\* The structure of P2RF-□-E models provides finger protection. Round terminals cannot be used. Use forked crimp terminals.

### Accessories for Push-In Plus Terminal Block Sockets (P2RF-□-PU)

#### Short Bars

Pitch	No. of poles	Colors	Model *	Minimum order (quantity)
7.75 mm	2	Red (R) Blue (S) Yellow (Y)	PYDN-7.75-020□	10
	3		PYDN-7.75-030□	
	4		PYDN-7.75-040□	
	20		PYDN-7.75-200□	
15.5 mm	8		PYDN-15.5-080□	

**Note:** Use the Short Bars for crossover wiring within one Socket or between Sockets.

\* Replace the box (□) in the model number with the code for the covering color.

#### Labels

Model	Minimum order (sheet) (quantity per sheet)
XW5Z-P4.0LB1	5 1 sheet (60 pieces)

### Accessories for Screw Terminal Sockets (P2RFZ-□-E)

#### Short Bars

Pitch	No. of poles	Colors	Model	Minimum order (set)
6.8 mm	10	Blue (S)	P2DN-6.8-100S	1 One set (order unit) contains 10 short bars and 20 caps.
15.7 mm	10		P2DN-15.7-100S	

**Note:** 1. Use the Short Bars for crossover wiring within one Socket or between Sockets.

2. Cannot be used on the P2RF-□-E.

#### Labels

Model	Minimum order (sheet) (quantity per sheet)
XW5Z-P2.5LB1	5 1 sheet (72 pieces)

### Accessories for Short Bars (P2DN)

#### Cap

Model	Minimum order (bag)
P2DN-CP100	1 (100 pcs./bag)

### Mounting Tracks

Applicable Socket	Description	Model	Minimum order (quantity)
Track-connecting Socket	Mounting track	50 cm (ℓ) × 7.3 mm (t):	PFP-50N
		1 m (ℓ) × 7.3 mm (t):	PFP-100N
		1 m (ℓ) × 16 mm (t):	PFP-100N2
	End plate *1	PFP-M	10
Spacer	PFP-S		
Back-connecting Socket	Mounting plate *2	P2R-P	1

\*1. When mounting DIN rail, please use End Plate (PFP-M).

\*2. Used to mount several P2R-05A and P2R-08A Connecting Sockets side by side.

## Specifications

### Coil Ratings

Rated voltage		Rated current*		Coil resistance	Coil inductance (H) (ref. value)		Must operate voltage	Must release voltage	Max. voltage	Power consumption (approx.)
		50 Hz	60 Hz		Armature OFF	Armature ON				
AC	24 V	43.5 mA	37.4 mA	253 Ω	0.81	1.55	80% max.	30% max.	110%	0.9 VA at 60 Hz
	48 V	21.8 mA	18.8 mA	1,040 Ω	3.12	6.17				
	110 V	9.5 mA	8.2 mA	5,566 Ω	13.33	26.83				
	120 V	8.6 mA	7.5 mA	7,286 Ω	16.13	32.46				
	230 V	4.4 mA	3.8 mA	27,172 Ω	72.68	143.90				
	240 V	4.2 mA	3.7 mA	27,800 Ω	90.58	182.34				

Rated voltage		Rated current*		Coil resistance	Coil inductance (H) (ref. value)		Must operate voltage	Must release voltage	Max. voltage	Power consumption (approx.)
					Armature OFF	Armature ON				
DC	6 V	87.0 mA		69 Ω	0.25	0.48	70% max.	15% min.	110%	0.53 W
	12 V	43.2 mA		278 Ω	0.98	2.35				
	24 V	21.6 mA		1,113 Ω	3.60	8.25				
	48 V	11.4 mA		4,220 Ω	15.2	29.82				

- Note:**
1. The rated current and coil resistance are measured at a coil temperature of 23°C with tolerances of +15%/-20% for the AC rated current and ±10% for the DC coil resistance.
  2. The AC coil resistance and inductance values are reference values only (at 60 Hz).
  3. Operating characteristics were measured at a coil temperature of 23°C.
  4. The maximum voltage is the maximum possible value of the voltage that can be applied to the relay coil. It is not the maximum voltage that can be applied continuously.

### Contact Ratings

Number of poles	1 pole		2 poles	
Load	Resistive load (cosφ = 1)	Inductive load (cosφ = 0.4; L/R = 7 ms)	Resistive load (cosφ = 1)	Inductive load (cosφ = 0.4; L/R = 7 ms)
Rated load	10 A at 250 VAC; 10 A at 30 VDC	7.5 A at 250 VAC; 5 A at 30 VDC	5 A at 250 VAC; 5 A at 30 VDC	2 A at 250 VAC; 3 A at 30 VDC
Rated carry current	10 A		5 A	
Max. switching voltage	440 VAC, 125 VDC		380 VAC, 125 VDC	
Max. switching current	10 A		5 A	
Max. switching power	2,500 VA, 300 W	1,875 VA, 150 W	1,250 VA, 150 W	500 VA, 90 W
Failure rate (reference value) *	100 mA at 5 VDC		10 mA at 5 VDC	

**Note:** P level:  $\lambda_{60} = 0.1 \times 10^{-6}$ /operation

\* This value was measured at a switching frequency of 120 operations per minute.

## Characteristics

Item	1 pole	2 poles
Contact configuration	SPDT	
Contact structure	Single	
Contact resistance	100 mΩ max.	
Operate (set) time	15 ms max.	
Release (reset) time	AC: 10 ms max.; DC: 5 ms max. (w/built-in diode: 20 ms max.)	AC: 15 ms max.; DC: 10 ms max. (w/built-in diode: 20 ms max.)
Max. operating frequency	Mechanical: 18,000 operations/hr Electrical: 1,800 operations/hr (under rated load)	
Insulation resistance	1,000 MΩ min. (at 500 VDC)	
Dielectric strength *	5,000 VAC, 50/60 Hz for 1 min between coil and contacts; 1,000 VAC, 50/60 Hz for 1 min between contacts of same polarity	5,000 VAC, 50/60 Hz for 1 min between coil and contacts; 3,000 VAC, 50/60 Hz for 1 min between contacts of different polarity 1,000 VAC, 50/60 Hz for 1 min between contacts of same polarity
Vibration resistance	Destruction: 10 to 55 to 10 Hz, 0.75 mm single amplitude (1.5 mm double amplitude) Malfunction: 10 to 55 to 10 Hz, 0.75 mm single amplitude (1.5 mm double amplitude)	
Shock resistance	Destruction: 1,000 m/s <sup>2</sup> Malfunction: 200 m/s <sup>2</sup> when energized; 100 m/s <sup>2</sup> when not energized	
Endurance	Mechanical: AC coil: 10,000,000 operations min.; DC coil: 20,000,000 operations min. (at 18,000 operations/hr) Electrical: 100,000 operations min. (at 1,800 operations/hr under rated load)	
Ambient temperature	Operating: -40°C to 70°C (with no icing or condensation)	
Ambient humidity	Operating: 5% to 85%	
Weight	Approx. 20 g	

Note: Values in the above table are the initial values.

\*These values are relay only. Please refer to the "Products Related to Common Sockets and DIN Tracks Data Sheet" for connecting sockets.

## Approved Standards

### UL 508 (File No. E41643)

Model	Contact form	Coil ratings	Contact ratings	Operations
G2R-1-S (S)	SPDT	5 to 110 VDC 6 to 240 VAC	10 A, 30 VDC (resistive) 10 A, 250 VAC (general use)	100 × 10 <sup>3</sup>
			TV-3 (NO contact only)	25 × 10 <sup>3</sup>
G2R-2-S (S)	DPDT	5 to 110 VDC 6 to 240 VAC	5 A, 30 VDC (resistive) 5 A, 250 VAC (general use)	100 × 10 <sup>3</sup>
			TV-3 (NO contact only)	25 × 10 <sup>3</sup>

### CSA 22.2 No.0, No.14

#### (File No. LR31928)

Model	Contact form	Coil ratings	Contact ratings	Operations
G2R-1-S (S)	SPDT	5 to 110 VDC 6 to 240 VAC	10 A, 30 VDC (resistive) 10 A, 250 VAC (general use)	100 × 10 <sup>3</sup>
			TV-3 (NO contact only)	25 × 10 <sup>3</sup>
G2R-2-S (S)	DPDT	5 to 110 VDC 6 to 240 VAC	5 A, 30 VDC (resistive) 5 A, 250 VAC (general use)	100 × 10 <sup>3</sup>
			TV-3 (NO contact only)	25 × 10 <sup>3</sup>

### IEC/VDE (Certificate No. 40015012 EN 61810-1)

Contact form	Coil ratings	Contact ratings	Operations
1 pole	6, 12, 24, 48 VDC 24, 110, 120, 230, 240 VAC	5 A, 440 VAC (cosφ = 1.0) 10 A, 250 VAC (cosφ = 1.0) 10 A, 30 VDC (0 ms)	100 × 10 <sup>3</sup>
2 poles	6, 12, 24, 48 VDC 24, 110, 120, 230, 240 VAC	5 A, 250 VAC (cosφ = 1.0) 5 A, 30 VDC (0 ms)	100 × 10 <sup>3</sup>

### LR

Number of poles	Coil ratings	Contact ratings	Operations
1 pole	5 to 110 VDC 6 to 240 VDC	10 A, 250 VAC (general use) 7.5 A, 250 VAC (PF0.4) 10 A, 30 VDC (resistive) 5A, 30VDC (L/R=7ms)	100 × 10 <sup>3</sup>
2 poles	5 to 110 VDC 6 to 240 VDC	5 A, 250 VAC (general use) 2 A, 250 VAC (PF0.4) 5 A, 30 VDC (resistive) 3A, 30VDC (L/R=7ms)	100 × 10 <sup>3</sup>

# Engineering Data

## Maximum Switching Power

G2R-1-S (S)

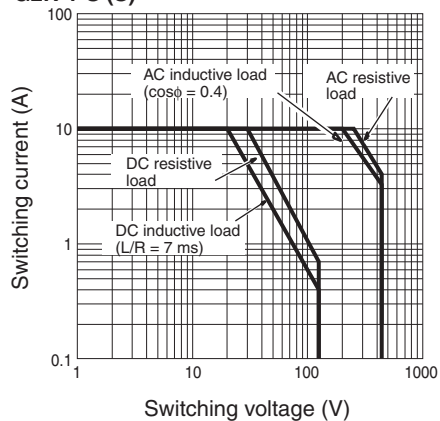

G2R-2-S (S)

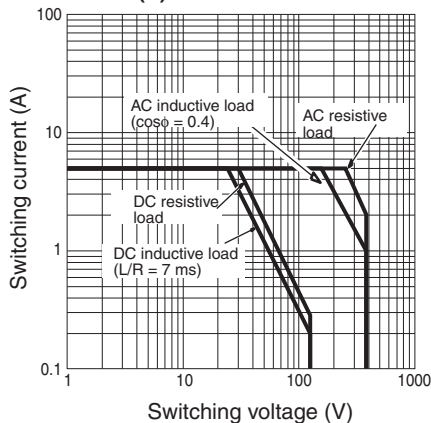

## Endurance

G2R-1-S (S)

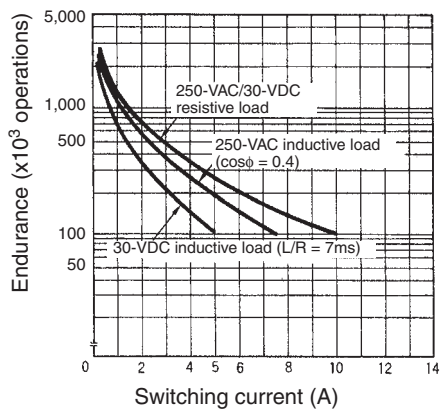

G2R-2-S (S)

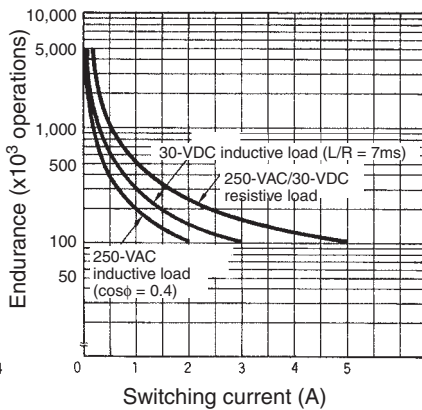

## Ambient Temperature vs Maximum Coil Voltage

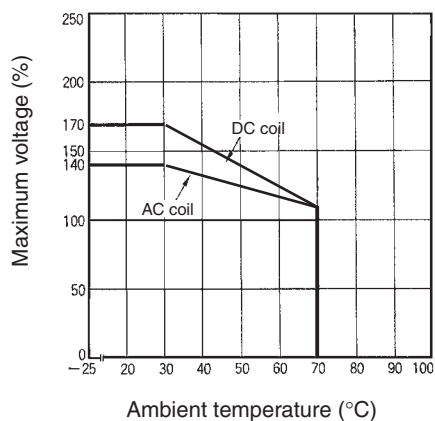

# Dimensions

Note: All units are in millimeters unless otherwise indicated.

## SPDT Relays

G2R-1-S (S), G2R-1-SN (S), G2R-1-SNI (S)  
 G2R-1-SD (S), G2R-1-SND (S), G2R-1-SNDI (S)

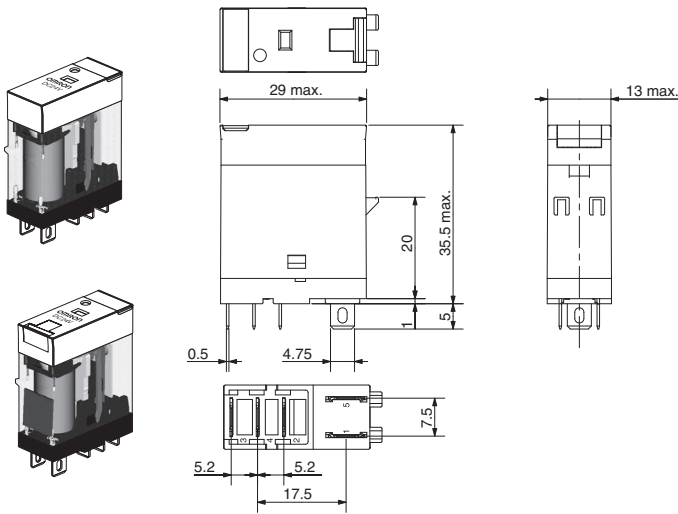

## Terminal Arrangement/Internal Connections (Bottom View)

G2R-1-S (S)

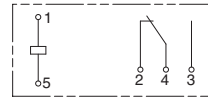

G2R-1-SD (S) (DC)

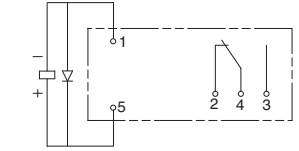

G2R-1-SN (S), G2R-1-SNI (S) (AC)

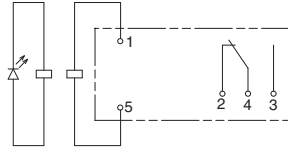

G2R-1-SN (S), G2R-1-SNI (S) (DC)

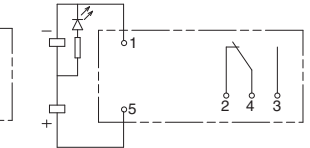

G2R-1-SND (S), G2R-1-SNDI (S) (DC)

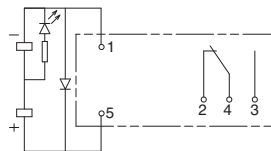

## DPDT Relays

G2R-2-S (S), G2R-2-SN (S), G2R-2-SNI (S)  
 G2R-2-SD (S), G2R-2-SND (S), G2R-2-SNDI (S)

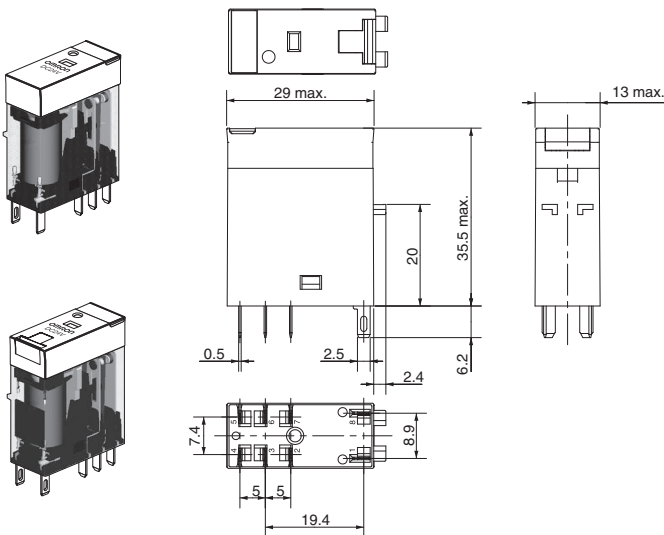

## Terminal Arrangement/Internal Connections (Bottom View)

G2R-2-S (S)

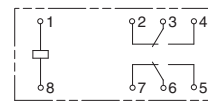

G2R-2-SD (S) (DC)

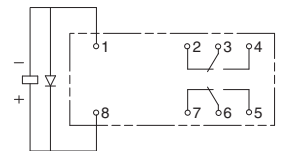

G2R-2-SN (S), G2R-2-SNI (S) (AC)

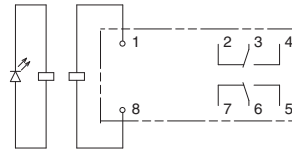

G2R-2-SN (S), G2R-2-SNI (S) (DC)

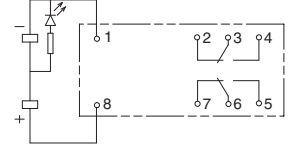

G2R-2-SND (S), G2R-2-SNDI (S) (DC)

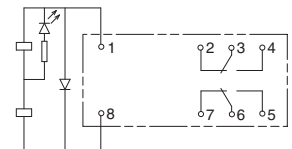

Track/Surface Mounting Sockets

P2RF-05-PU

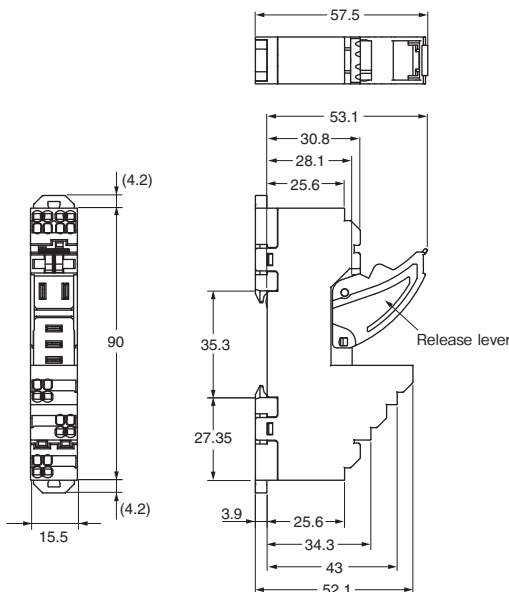

Terminal Arrangement/  
Internal Connection Diagram  
(Top View)

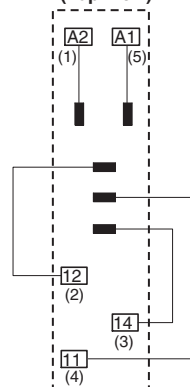

Mounting Hole  
Dimensions

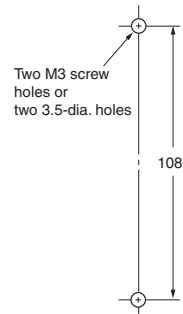

**Note:** The numbers in parentheses are traditionally used terminal numbers.

**Note:** Pull out the hooks to mount the Socket with screws.

P2RF-08-PU

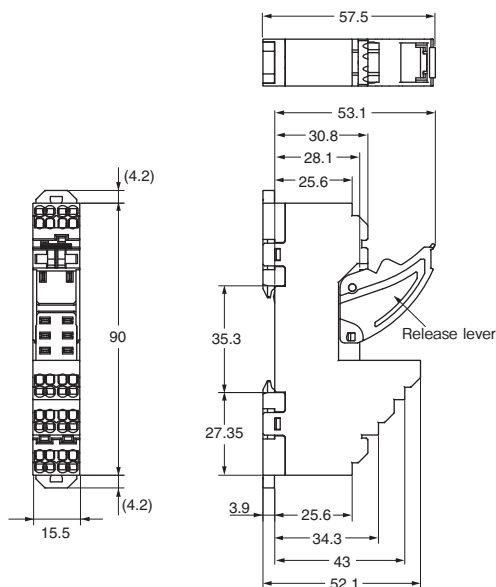

Terminal Arrangement/  
Internal Connection Diagram  
(Top View)

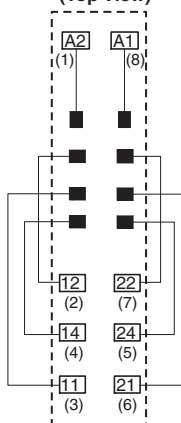

Mounting Hole  
Dimensions

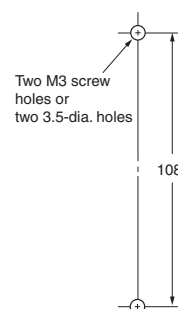

**Note:** The numbers in parentheses are traditionally used terminal numbers.

**Note:** Pull out the hooks to mount the Socket with screws.

Accessories for P2RF-□-PU

Short Bars

PYDN-7.75-□□ (7.75 mm)

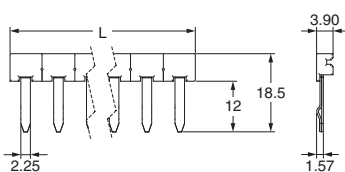

PYDN-15.5-080□ (15.5 mm)

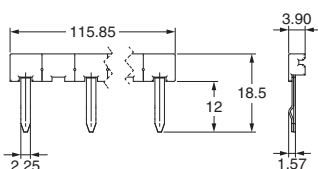

Application	Pitch	No. of poles	L (Length)	Colors	Model *	Maximum carry current
For Contact terminals (common)	7.75 mm	2	15.1	Red (R) Blue (S) Yellow (Y)	PYDN-7.75-020□	20 A
		3	22.85		PYDN-7.75-030□	
		4	30.6		PYDN-7.75-040□	
		20	154.6		PYDN-7.75-200□	
For Coil terminals	15.5 mm	8	115.85		PYDN-15.5-080□	

\* Replace the box (□) in the model number with the code for the covering color.

**Note:** 1. Use the Short Bars for crossover wiring within one Socket or between Sockets.  
2. When using short bar to coil terminals of PYF-□□-PU, make sure to use PYDN-31.0-080□ (31 mm).  
When using short bar to coil terminals of P2RF-□□-PU, make sure to use PYDN-15.5-080□ (15.5 mm).

**P2RFZ-05-E**

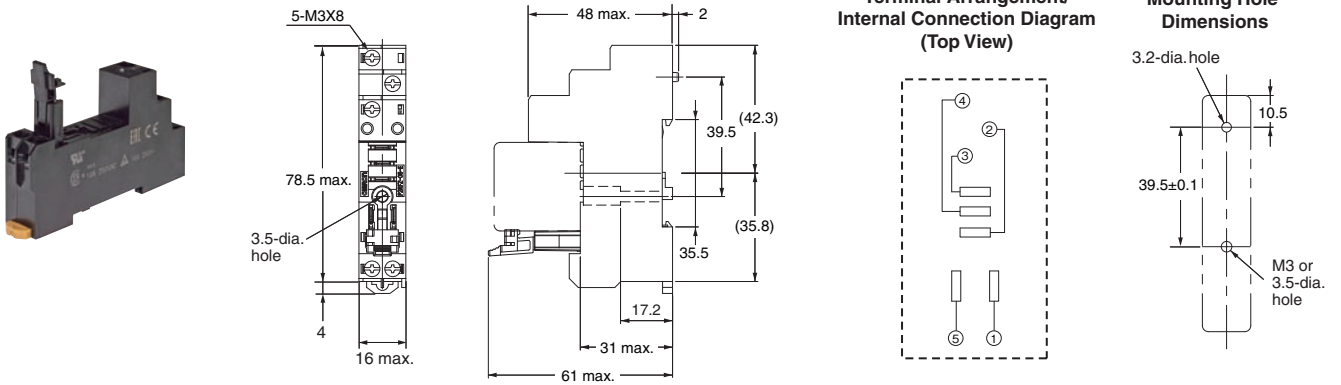

**P2RFZ-08-E**

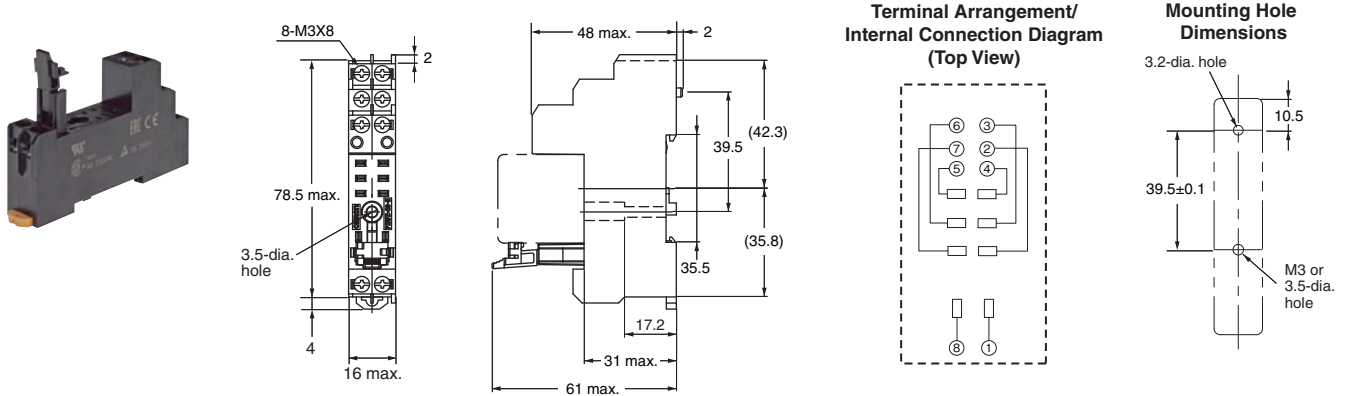

**Accessories for P2RFZ-□-E**

**Short Bars**

**P2DN-6.8-100S (6.8 mm)**

Maximum carry current: 20A

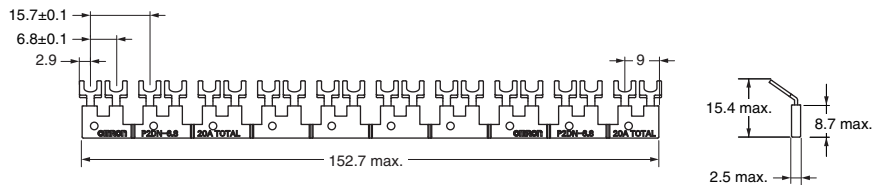
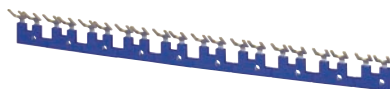

**P2DN-15.7-100S (15.7 mm)**

Maximum carry current: 20A

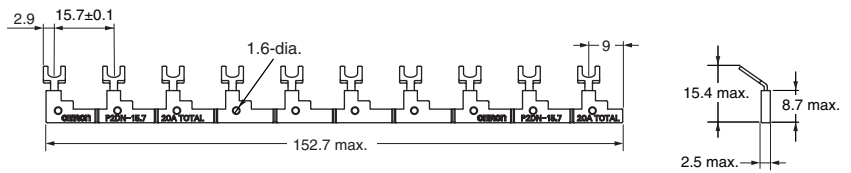

**Note:** Each Short Bar set comes with 20 Caps.

**Accessories for P2DN**

**Cap**

**P2DN-CP100**

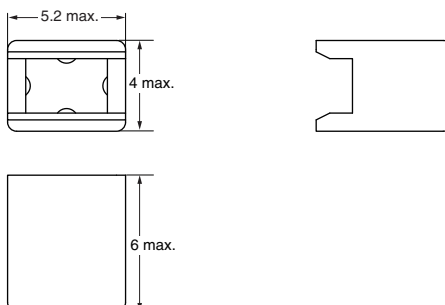



P2RF-05-E

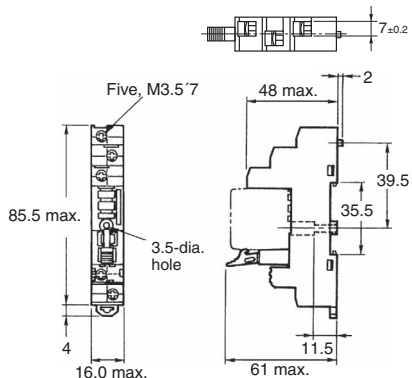
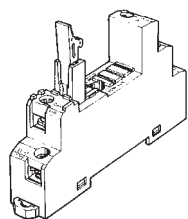

Terminal Arrangement (Top View)

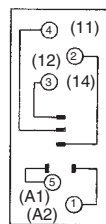

Mounting Holes (for Surface Mounting)

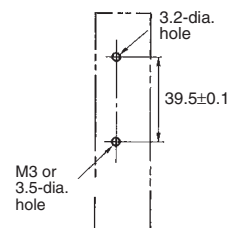

Note: Pin numbers in parentheses apply to DIN standard.

P2RF-08-E

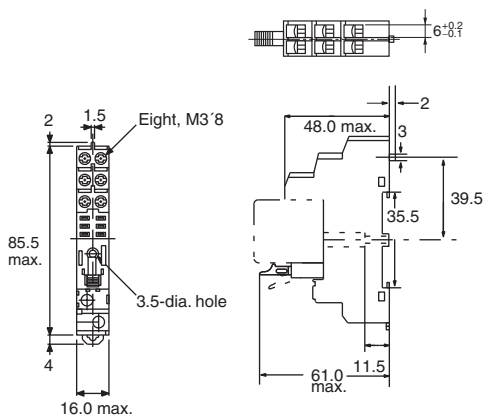
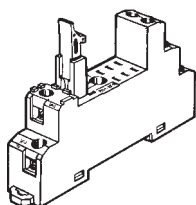

Terminal Arrangement (Top View)

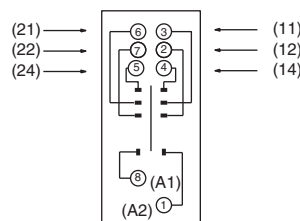

Mounting Holes (for Surface Mounting)

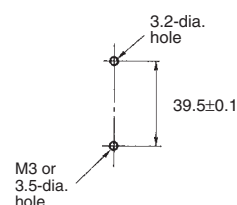

P2RF-05

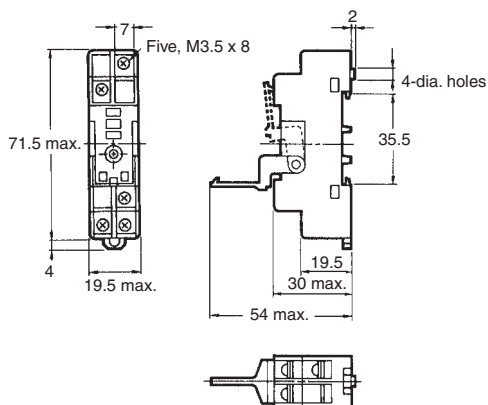
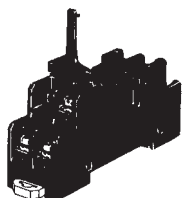

Terminal Arrangement (Top View)

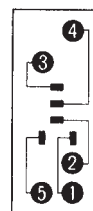

Mounting Holes (for Surface Mounting)

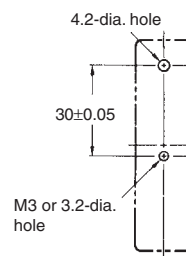

P2RF-08

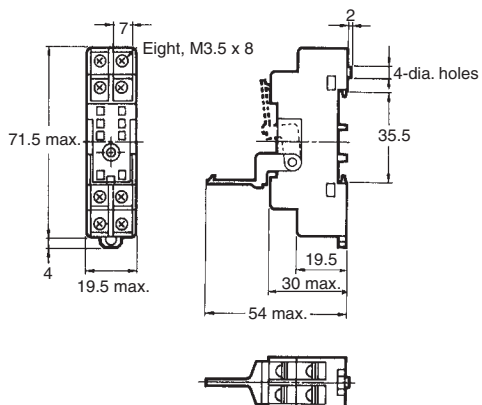
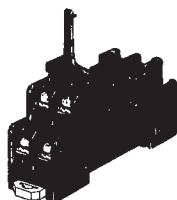

Terminal Arrangement (Top View)

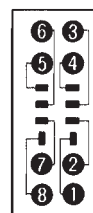

Mounting Holes (for Surface Mounting)

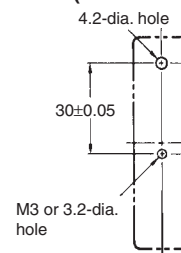

Mounting Height of Relay with Track/Surface Mounting Sockets

P2RF-05-PU

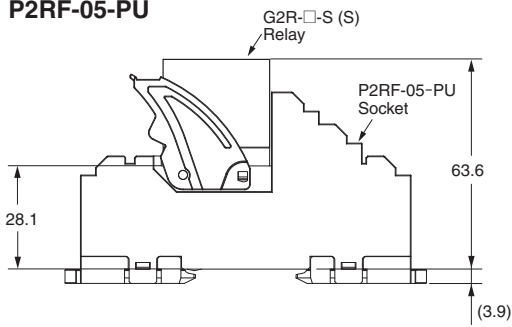

P2RF-08-PU

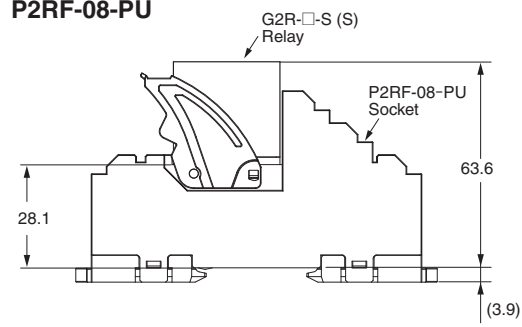

P2RFZ-E

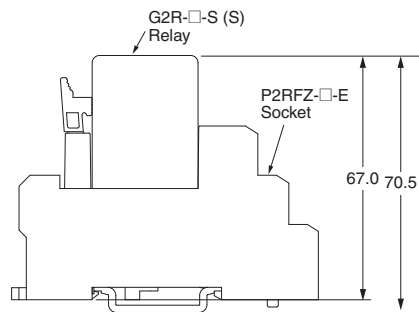

P2RF-□

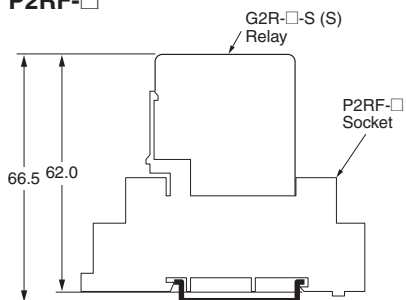

P2RF-□-E

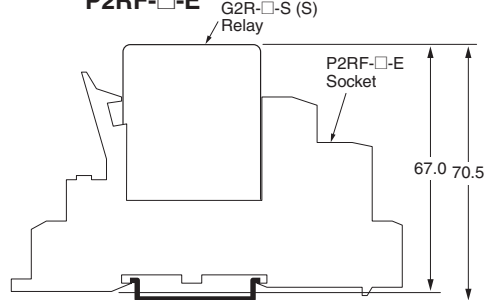

Back-connecting Sockets

P2R-05P (1-pole)

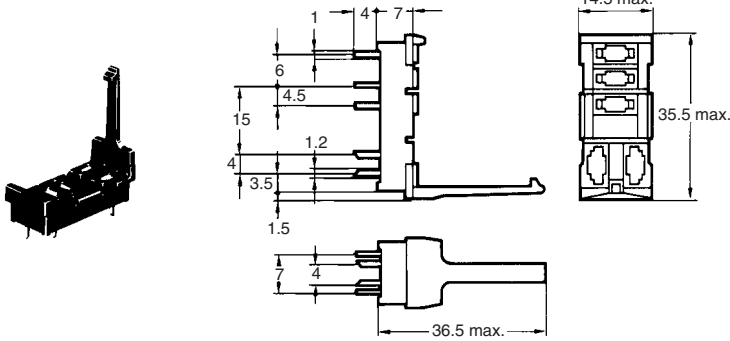

Terminal Arrangement (Bottom View)

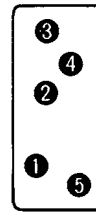

Mounting Holes

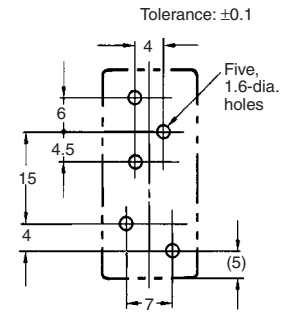

P2R-08P (2-pole)

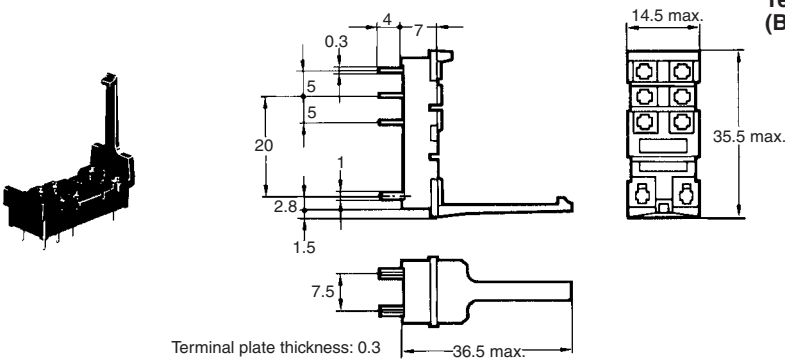

Terminal Arrangement (Bottom View)

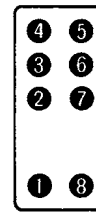

Mounting Holes

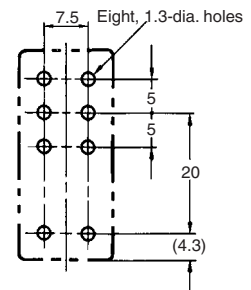

P2R-05A (1-pole)

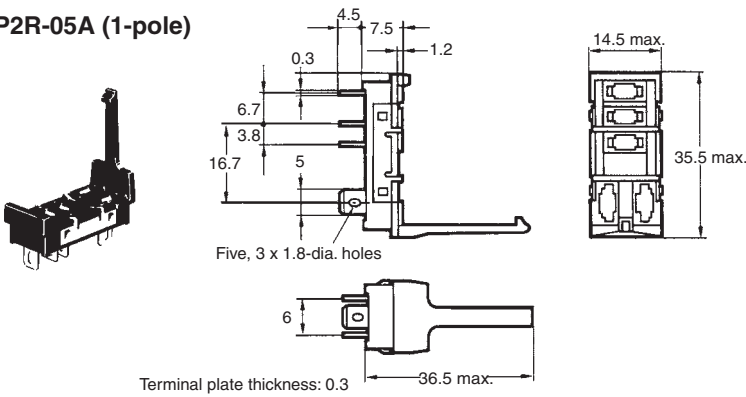

Terminal Arrangement (Bottom View)



Panel Cutout

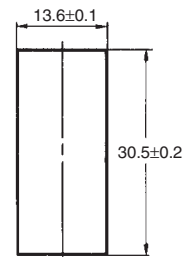

P2R-08A (2-pole)

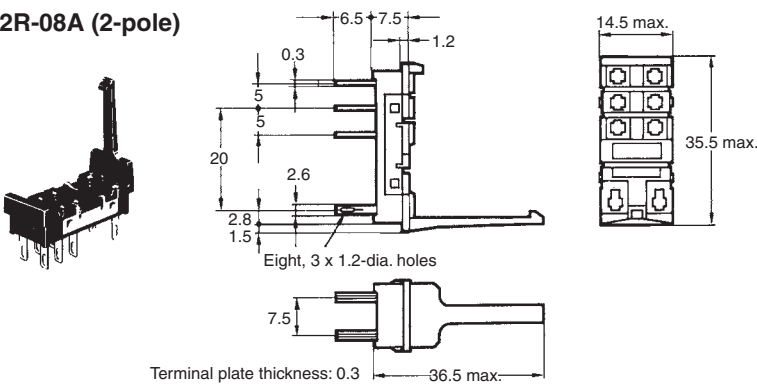

Recommended thickness of the panel is 1.6 to 2.0 mm

**P2R-057P (1-pole)**

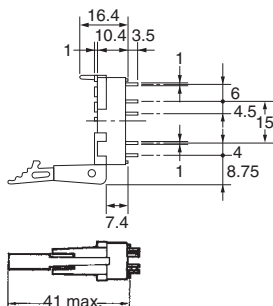
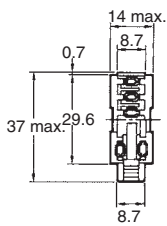
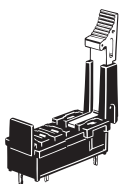

**Terminal Arrangement (Bottom View)**

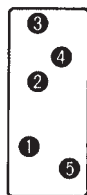

**Mounting Holes**

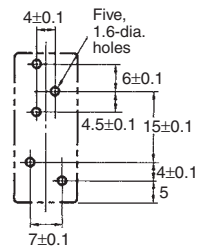

**P2R-087P (2-pole)**

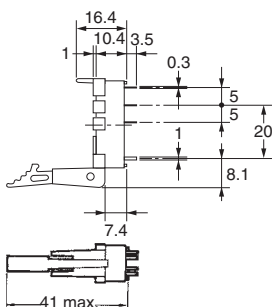
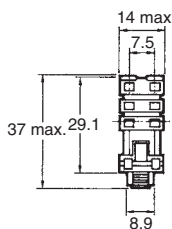
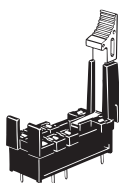

**Terminal Arrangement (Bottom View)**

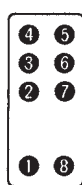

**Mounting Holes**

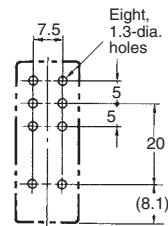

**Mounting Height of Relay with Back-connecting Sockets**

**P2R-□P**

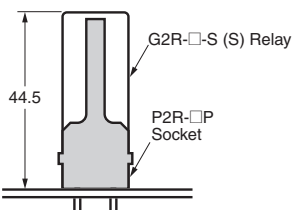

**P2R-□A**

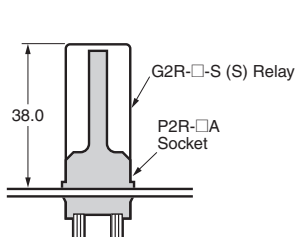

**P2R-□7P**

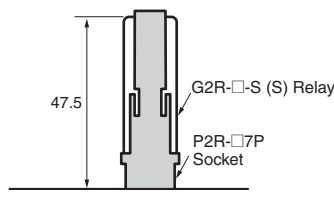

**Mounting Tracks**

**PFP-100N, PFP-50N**

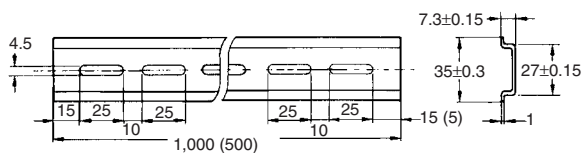

**PFP-100N2**

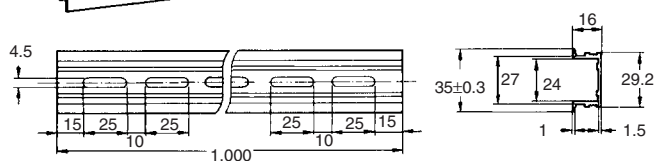
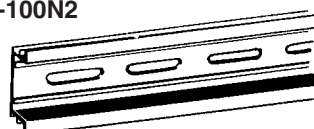

It is recommended to use a panel 1.6 to 2.0 mm thick.

End Plate

PFP-M

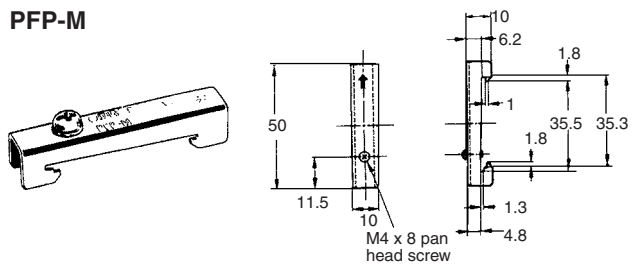

Spacer

PFP-S

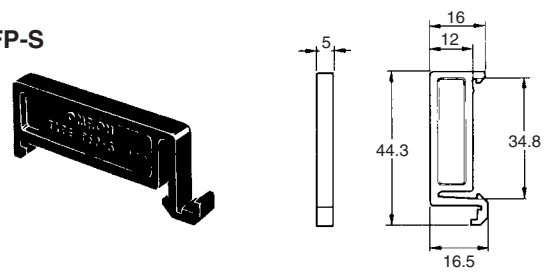

Mounting Plate

P2R-P

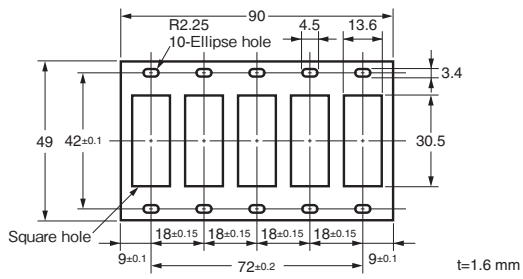

## Safety Precautions

Be sure to read the *Common Precautions for All Relay* in the website at the following URL:  
<http://www.ia.omron.com/>.

Refer to *Products Related to Common Sockets and DIN Tracks* for precautions on the applicable Sockets.

Refer to *PYF-□□-PU/P2RF-□□-PU* for precautions on Push-In Plus Terminal Block Sockets.

### Warning Indications

 <b>CAUTION</b>	Indicates a potentially hazardous situation which, if not avoided, may result in minor or moderate injury or in property damage.
<b>Precautions for Correct Use</b>	Supplementary comments on what to do or avoid doing to prevent failure to operate, malfunction, or undesirable effects on product performance.

### Cation

- Do not use the test button for any purpose other than testing. Be sure not to touch the test button accidentally as this will turn the contacts ON. Before using the test button, confirm that circuits, the load, and any other connected item will operate safely.
- Check that the test button is released before turning ON relay circuits.
- If the test button is pulled out too forcefully, it may bypass the momentary testing position and go straight into the locked position.
- Use an insulated tool when you operate the test button.

### Precautions for Correct Use

#### About the Built-in Diodes

The diodes that are built into the Relays are designed to absorb reverse voltage from the Relay's coil. If a large surge in voltage is applied to the diode from an external source, the element will be destroyed.

If there is the possibility of large voltage surges that could be applied to the elements from an external source, take any necessary surge absorption measures.

#### Latching Levers

- Turn OFF the power supply when operating the latching lever. After you use the latching lever always return it to its original state.
- Do not use the latching lever as a switch.
- The latching lever can be used for 100 operations minimum.

#### Relay Replacement

To replace the Relay, turn OFF the power supply to the load and Relay coil sides to prevent unintended operation and possible electrical shock.

#### Coil tape color

Pink tape is used for the AC coil type and blue tape is used for the DC coil type, making it easy to distinguish AC and DC.

#### Using a short-circuit bar

- Use the short-circuit bar that is suitable for the socket you are using and the location of use.
- Note that the P2DN short-circuit bar for the P2RFZ-E Socket has both a short-circuit bar for shorting coil terminals and a short-circuit bar for shorting contact COM terminals.
- The short-circuit bar can be cut to match any number of poles. Cut with a tool as appropriate for the number of relays and sockets. When using a cut short-circuit bar, take care to avoid injuring yourself on the cut surface.

- When cutting with a tool, insert the tool from the plastic part and cut along the slot in the plastic part between terminals. If you cut a part other than the slot in the plastic part between terminals, it may not be possible to attach the insulating cap.

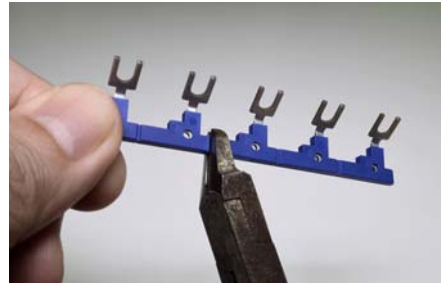

- When using a cut short-circuit bar (P2DN), always use the provided cap to protect the charger part.

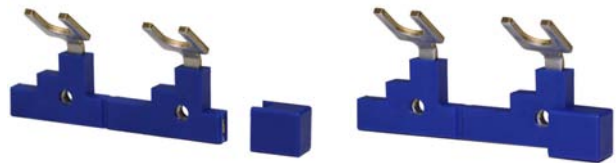

- The proper orientation for installing the short-circuit bar is with the molded part facing inward.

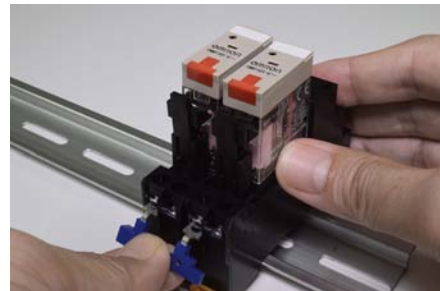

- Use the short-circuit bar to short-circuit two or more coil terminals, or two or more contact COM terminals.
- Do not use a deformed short-circuit bar. Risk of failure, malfunctioning, or deterioration of characteristics.
- In socket terminals, insert the short-circuit bar in the correct orientation all the way into all terminals, and then secure with screws.
- Install the short -circuit bar before wiring.

### Equivalent Labels from Other Companies and Recommended Label Printers

Use the following label printer.

The following table gives the manufacturer's model number as of March 2017.

Manufacturer	Omron	Phoenix Contact	Weidmuller	Cembre
Label	XW5Z-P4.0LB1	UCT-TM6	MF 10/6	MG-CPM-04 41391
	XW5Z-P2.5LB2	UCT-TMF5	---	---
Label printer	--- *	BLUEMARK CLED, THERMOMARK CARD SET PLUS, THERMOMARK CARD	PrintJet ADVANCED, Plotter MCP Plus, Plotter MCP Basic	Markingenius MG3

\* When using a printing tool, use a Phoenix Contact label printer.

**Note:** Ask the label manufacturer or printer manufacturer for details.

**OMRON AUTOMATION AMERICAS HEADQUARTERS** • Chicago, IL USA • 847.843.7900 • 800.556.6766 • automation.omron.com

**OMRON CANADA, INC. • HEAD OFFICE**

Toronto, ON, Canada • 416.286.6465 • 866.986.6766 • automation.omron.com

**OMRON ELECTRONICS DE MEXICO • HEAD OFFICE**

Ciudad de México • 52.55.5901.4300 • 01.800.386.6766 • mela@omron.com

**OMRON ELECTRONICS DE MEXICO • SALES OFFICE**

San Pedro Garza García, N.L. • 81.12.53.7392 • 01.800.386.6766 • mela@omron.com

**OMRON ELECTRONICS DE MEXICO • SALES OFFICE**

Eugenio Garza Sada, León, Gto • 01.800.386.6766 • mela@omron.com

**OMRON ELETRÔNICA DO BRASIL LTDA • HEAD OFFICE**

São Paulo, SP, Brasil • 55 11 5171-8920 • automation.omron.com

**OMRON ARGENTINA • SALES OFFICE**

Buenos Aires, Argentina • +54.11.4521.8630 • +54.11.4523.8483  
mela@omron.com

**OTHER OMRON LATIN AMERICA SALES**

+54.11.4521.8630 • +54.11.4523.8483 • mela@omron.com

*Authorized Distributor:*

**Controllers & I/O**

- Machine Automation Controllers (MAC) • Motion Controllers
- Programmable Logic Controllers (PLC) • Temperature Controllers • Remote I/O

**Robotics**

- Industrial Robots • Mobile Robots

**Operator Interfaces**

- Human Machine Interface (HMI)

**Motion & Drives**

- Machine Automation Controllers (MAC) • Motion Controllers • Servo Systems
- Frequency Inverters

**Vision, Measurement & Identification**

- Vision Sensors & Systems • Measurement Sensors • Auto Identification Systems

**Sensing**

- Photoelectric Sensors • Fiber-Optic Sensors • Proximity Sensors
- Rotary Encoders • Ultrasonic Sensors

**Safety**

- Safety Light Curtains • Safety Laser Scanners • Programmable Safety Systems
- Safety Mats and Edges • Safety Door Switches • Emergency Stop Devices
- Safety Switches & Operator Controls • Safety Monitoring/Force-guided Relays

**Control Components**

- Power Supplies • Timers • Counters • Programmable Relays
- Digital Panel Meters • Monitoring Products

**Switches & Relays**

- Limit Switches • Pushbutton Switches • Electromechanical Relays
- Solid State Relays

**Software**

- Programming & Configuration • Runtime

## X-ON Electronics

Largest Supplier of Electrical and Electronic Components

*Click to view similar products for [General Purpose Relays](#) category:*

*Click to view products by [Omron](#) manufacturer:*

Other Similar products are found below :

[PCN-105D3MH,000](#) [59641F200](#) [LY1SAC110120](#) [5X827E](#) [5X837F](#) [5X840F](#) [5X842F](#) [5X848E](#) [LY2N-AC120](#) [LY2S-AC220/240](#) [LY2-US-AC120](#) [LY3-US-AC120](#) [LY4F-UA-DC12](#) [LY4F-UA-DC24](#) [LY4F-US-AC120](#) [LY4F-US-AC240](#) [LY4F-US-DC24](#) [LY4F-VD-AC110](#) [LYQ20DC12](#) [M115C60](#) [M115N010](#) [M115N0150](#) [6031007G](#) [603-12D](#) [61211T0B4](#) [61212T400](#) [61222Q400](#) [61243B600](#) [61243C500](#) [61243Q400](#) [61311BOA2](#) [61311BOA6](#) [61311BOA8](#) [61311C0A2](#) [61311COA1](#) [61311COA6](#) [61311F0A2](#) [61311QOA1](#) [61311QOA4](#) [61311T0D6](#) [61311TOA6](#) [61311TOA7](#) [61311TOB3](#) [61311TOB4](#) [61311U0A6](#) [61312Q600](#) [61312T400](#) [61312T600](#) [61313U200](#) [61313U400](#)