

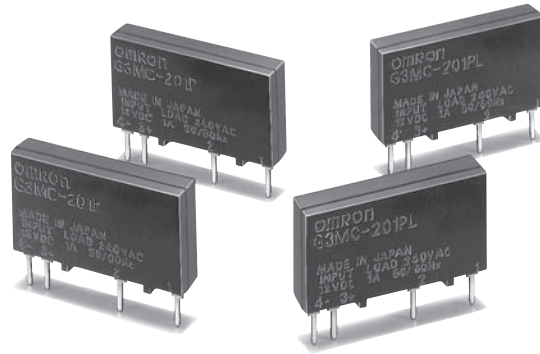

## Reinforced Insulation Models Added to Compact, Thin-profile Series of SSRs for PCBs

- 4.5-mm thin design for high-density PCB applications.
- DC input and AC output for applicable load of 1A (at 40°C) and 2A (at 25°C).
- Compact, thin-profile SSR of monoblock construction with an all-in-one lead frame incorporates a PCB, terminals and heat sink



**RoHS Compliant**



Refer to "Solid State Relays Common Precautions".

### Model Number Legend

G3MC-

|   |   |   |   |   |   |
|---|---|---|---|---|---|
| □ | □ | □ | □ | □ | □ |
| 1 | 2 | 3 | 4 | 5 |   |

#### 1. Rated Load Power Supply Voltage

- 1: Maximum operating voltage lower than 132 V
- 2: Maximum operating voltage lower than 264 V

#### 2. Rated Load Current

- 01: 1 A
- 02: 2 A

#### 3. Terminal Type

- P: PCB terminals

#### 4. Zero Cross Function

- Blank: Equipped with zero cross function
- L : Not equipped with zero cross function

#### 5. Certification

- Blank: Certified by UL and CSA (standard models)
- VD : Certified by UL, CSA and EN
- VD-1: Certified by UL, CSA and EN (reinforced insulation models)

G3MC

### List of Models

| Isolation  | Zero cross function | Indicator | Snubber circuit       | Rated output load     | Rated input voltage                         | Model  | Minimum packing unit |  |
|------------|---------------------|-----------|-----------------------|-----------------------|---|--|----------------------|--|
| Phototriac | Yes                 | No        | Yes                   | 1 A at 100 to 120 VAC | 5 VDC                                       | G3MC-101P<br>G3MC-101P-VD                      | 100 pcs              |  |
|            |                     |           |                       |                       | 12 VDC                                      |  |                      |  |
|            |                     |           |                       |                       | 24 VDC                                      |  |                      |  |
|            | No                  |           |                       |                       | 5 VDC                                       | G3MC-101PL<br>G3MC-101PL-VD                    |                      |  |
|            |                     |           |                       |                       | 12 VDC                                      |  |                      |  |
|            |                     |           |                       |                       | 24 VDC                                      |  |                      |  |
|            | Yes                 | No        | Yes                   | 1 A at 100 to 240 VAC | 5 VDC                                       | G3MC-201P<br>G3MC-201P-VD<br>G3MC-201P-VD-1    |                      |  |
|            |                     |           |                       |                       | 12 VDC                                      |  |                      |  |
|            |                     |           |                       |                       | 24 VDC                                      |  |                      |  |
|            |                     |           |                       |                       | No  | 5 VDC  |                      | G3MC-201PL<br>G3MC-201PL-VD<br>G3MC-201PL-VD-1 |
|            |                     |           |                       |                       |   | 12 VDC   |                      |  |
|            |                     |           |                       |                       |   | 24 VDC   |                      |  |
| Yes        | No                  | Yes       | 2 A at 100 to 240 VAC | 5 VDC                 | G3MC-202P<br>G3MC-202P-VD<br>G3MC-202P-VD-1 |  |                      |  |
|            |                     |           |                       | 12 VDC                |   |  |                      |  |
|            |                     |           |                       | 24 VDC                |   |  |                      |  |
|            |                     |           |                       | No                    | 5 VDC                                       | G3MC-202PL<br>G3MC-202PL-VD<br>G3MC-202PL-VD-1 |                      |  |
|            |                     |           |                       |                       | 12 VDC                                      |  |                      |  |
|            |                     |           |                       |                       | 24 VDC                                      |  |                      |  |

### ■ Ratings (at an Ambient Temperature of 25°C)

● **Input** (Each model has 5-VDC, 12-VDC, and 24-VDC input versions.)

| Rated voltage | Operating voltage | Impedance    | Must operate voltage level | Must release voltage level |
|---------------|-------------------|--------------|----------------------------|----------------------------|
| 5 VDC         | 4 to 6 VDC        | 300Ω ± 20%   | 4 VDC max.                 | 1 VDC min.                 |
| 12 VDC        | 9.6 to 14.4 VDC   | 800Ω ± 20%   | 9.6 VDC max.               |                            |
| 24 VDC        | 19.2 to 28.8 VDC  | 1.6 kΩ ± 20% | 19.2 VDC max.              |                            |

● **Output**

| Model   | Item | Applicable load            |                           |              |                          |
|---|------|----------------------------|---------------------------|--------------|--------------------------|
|   |      | Rated load voltage         | Load voltage range        | Load current | Inrush current           |
| G3MC-101P (-VD)<br>G3MC-101PL (-VD)           |      | 100 to 120 VAC<br>50/60 Hz | 75 to 132 VAC<br>50/60 Hz | 0.1 to 1 A * | 8 A<br>(60 Hz, 1 cycle)  |
| G3MC-201P (-VD) (-1)<br>G3MC-201PL (-VD) (-1) |      | 100 to 240 VAC<br>50/60 Hz | 75 to 264 VAC<br>50/60 Hz |              |                          |
| G3MC-202P (-VD) (-1)<br>G3MC-202PL (-VD) (-1) |      | 100 to 240 VAC<br>50/60 Hz | 75 to 264 VAC<br>50/60 Hz | 0.1 to 2 A * | 30 A<br>(60 Hz, 1 cycle) |

\* The load current varies depending on the ambient temperature. Refer to Load Current vs. Ambient Temperature under Engineering Data.

### ■ Characteristics

| Item                          | Model | G3MC-101P(-VD)   | G3MC-101PL(-VD) | G3MC-201P(-VD)(-1)<br>G3MC-202P(-VD)(-1)   | G3MC-201PL(-VD)(-1)<br>G3MC-202PL(-VD)(-1) |
|-------------------------------|-------|--|-----------------|--|--|
| Operate time                  |       | 1/2 of load power source cycle + 1 ms max.   | 1 ms max.       | 1/2 of load power source cycle + 1 ms max. | 1 ms max.                                  |
| Release time                  |       | 1/2 of load power source cycle + 1 ms max.   |                 |  |  |
| Output ON voltage drop        |       | 1.6 V (RMS) max.   |                 |  |  |
| Leakage current               |       | 1 mA max. (at 100 VAC)   |                 | 1.5 mA max. (at 200 VAC)                   |  |
| Insulation resistance         |       | 1,000 MΩ min. (at 500 VDC)   |                 |  |  |
| Dielectric strength           |       | 2,500 VAC, 50/60 Hz for 1 min between input and output (3,000 VAC, 50/60 Hz for 1 min for G3MC-□□□-VD-1) |                 |  |  |
| Vibration resistance          |       | 10 to 55 to 10 Hz, 0.375-mm single amplitude (0.75-mm double amplitude)                                  |                 |  |  |
| Shock resistance              |       | 1,000 m/s <sup>2</sup>   |                 |  |  |
| Storage temperature           |       | -30°C to 100°C (with no icing or condensation)   |                 |  |  |
| Ambient operating temperature |       | -30°C to 80°C (with no icing or condensation)  |                 |  |  |
| Ambient operating humidity    |       | 45% to 85%RH   |                 |  |  |
| Weight                        |       | Approx. 2.5 g (Approx. 3.8 g for G3MC-202P(L)(-VD)(-1))  |                 |  |  |

### ■ Engineering Data

● **Load Current vs. Ambient Temperature**

G3MC-101P(-VD)  
G3MC-101PL(-VD)  
G3MC-201P(-VD)(-1)  
G3MC-201PL(-VD)(-1)

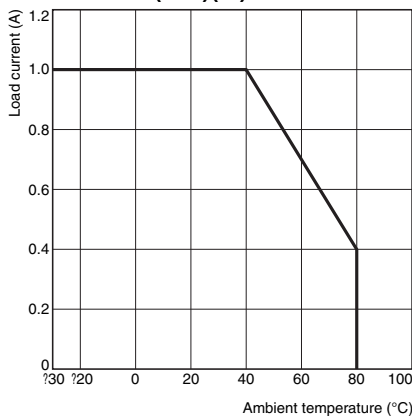

G3MC-202P(-VD)(-1)  
G3MC-202PL(-VD)(-1)

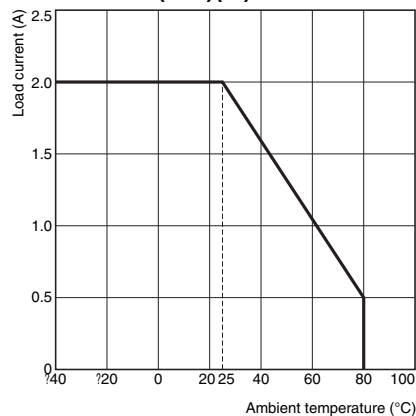

● **One Cycle Surge Current: Non-repetitive** Keep the inrush current to half the rated value if it occurs repeatedly.

**G3MC-101P(-VD)**  
**G3MC-101PL(-VD)**  
**G3MC-201P(-VD)(-1)**  
**G3MC-201PL(-VD)(-1)**

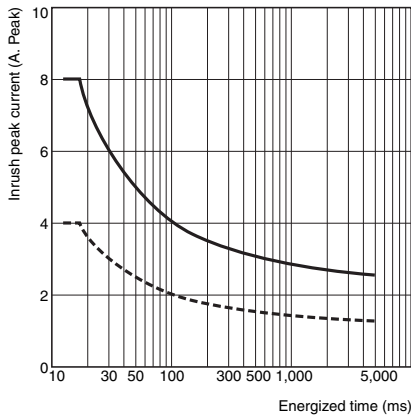

**G3MC-202P(-VD)(-1)**  
**G3MC-202PL(-VD)(-1)**

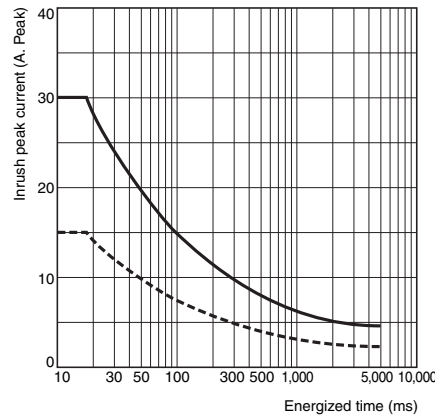

## Dimensions

(Unit: mm)

**G3MC-101P(-VD)**  
**G3MC-101PL(-VD)**  
**G3MC-201P(-VD)(-1)**  
**G3MC-201PL(-VD)(-1)**

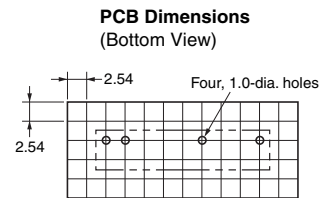
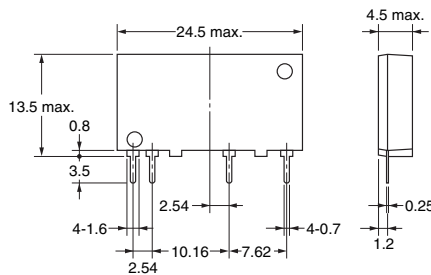
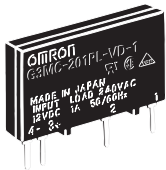

**Terminal Arrangement/ Internal Connections (Bottom View)**

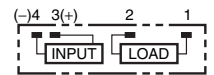

**G3MC-202P(-VD)(-1)**  
**G3MC-202PL(-VD)(-1)**

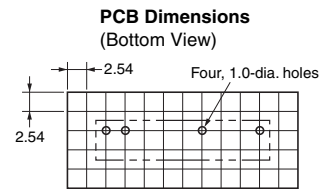
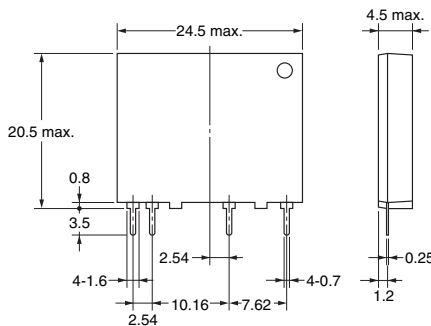
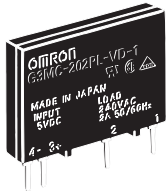

**Terminal Arrangement/ Internal Connections (Bottom View)**

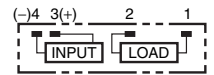

## Safety Precautions

● Please refer to “Solid State Relays Common Precautions” for correct use.

### Precautions for Correct Use

- The terminals are made of materials with high heat conduction. Complete reflow soldering within 10 seconds at a temperature of 260°C. Complete manual soldering within 5 seconds at a temperature of 350°C.
- The SSR has a thin profile. To maintain the vibration resistance of the SSR, make sure that the space between the SSR and PCB is 0.1 mm maximum. Lifting of the PCB can be prevented by setting the hole diameter of the PCBs on both sides in the PCB dimensions diagram to between 0.8 to 1.0 mm. If the terminals will be subjected to stress due to constant vibration, implement vibration countermeasures, such as with adhesive.
- Select the model without the zero-cross function when using the Unit for phase control output.
- The casing works as a heat sink. When mounting two or more SSRs close together, do not allow the ambient temperature to rise. If the rated current will flow, provide a space between the SSRs equivalent to the

thickness of one SSR and provide proper ventilation. If poor ventilation is unavoidable, reduce the load current by half.

- Although LOAD is incorporated with snubber circuit, do not wiring high voltage line and power line together with or in the same duct as the SSR. Doing so may result in malfunction or damage due to induction.
- The input circuit is not incorporated with reverse connection protection circuit. Make sure to check the polarity when wiring.
- Connect the surge absorbers (varistors) in parallel at both ends of the LOAD terminal when applying a surge voltage over 250 V peak for G3MC-10□P(L)(-VD), and over 450V peak for G3MC-20□P(L)(-VD)(-1).

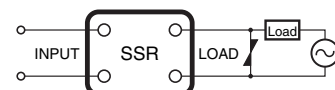

• Application examples provided in this document are for reference only. In actual applications, confirm equipment functions and safety before using the product.  
• Consult your OMRON representative before using the product under conditions which are not described in the manual or applying the product to nuclear control systems, railroad systems, aviation systems, vehicles, combustion systems, medical equipment, amusement machines, safety equipment, and other systems or equipment that may have a serious influence on lives and property if used improperly. Make sure that the ratings and performance characteristics of the product provide a margin of safety for the system or equipment, and be sure to provide the system or equipment with double safety mechanisms.

**Note: Do not use this document to operate the Unit.**

## X-ON Electronics

Largest Supplier of Electrical and Electronic Components

*Click to view similar products for [Solid State Relays - PCB Mount](#) category:*

*Click to view products by [Omron](#) manufacturer:*

Other Similar products are found below :

[M86F-2W](#) [M90F-2Y](#) [G2-1A07-ST](#) [G2-1A07-TT](#) [G2-1B02-TT](#) [G2-DA06-ST](#) [923812OCAS](#) [PLA134S](#) [DS11-1005](#) [AQH3213J](#) [AQV212J](#)  
[AQY412EHAJ](#) [EFR1200480A150](#) [901-7](#) [LCA220](#) [LCB110S](#) [1618400-5](#) [SR75-1ST](#) [AQH2213AJ](#) [AQV112KLJ](#) [AQV212AJ](#) [AQV238AD01](#)  
[AQW414TS](#) [AQY221N2SYD01](#) [AQY221R2VJ](#) [AQY275AXJ](#) [AQY414SXE01](#) [G2-1A02-ST](#) [G2-1A03-ST](#) [G2-1A03-TT](#) [G2-1A05-ST](#) [G2-](#)  
[1A06-TT](#) [G2-1A23-TT](#) [G2-1B01-ST](#) [G2-1B01-TT](#) [G2-1B02-ST](#) [G2-DA03-ST](#) [G2-DA03-TT](#) [G2-DA06-TT](#) [CPC1333GR](#) [3-1617776-2](#)  
[CTA2425](#) [TLP3131\(F\)](#) [LBA110S](#) [LBB110S](#) [LCA110LSTR](#) [LCB126S](#) [WPPM-0626D](#) [WPPM-3526D](#) [WPPM-3588D](#)