

# G3VM-□AR□/□DR□

MOS FET Relays DIP 4-pin, High-current and Low-ON-resistance Type

## MOS FET Relays in DIP 4-pin packages that achieve the low ON resistance and high switching capacity of a mechanical relay

- Load voltage: 20 V, 30V, 40 V, 60 V, 100 V, or 200 V
- 20-V Relay: Continuous load current of 3 A max.
- 30-V Relay: Continuous load current of 4 A max.
- 40-V Relay: Continuous load current of 2.5 A max.
- 60-V Relay: Continuous load current of 3 A max.
- 100-V Relay: Continuous load current of 2 A max.
- 200-V Relay: Continuous load current of 0.7 A max.

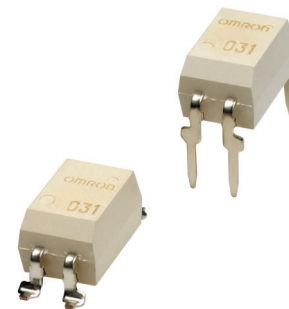

Note: The actual product is marked differently from the image shown here.

RoHS Compliant

### Application Examples

- Communication equipment
- Security equipment
- Power circuit
- Test & Measurement equipment
- Industrial equipment

### Package (Unit : mm, Average)

DIP 4-pin  
PCB Terminals

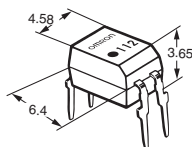

Surface-mounting Terminals

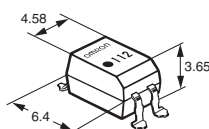

Note: The actual product is marked differently from the image shown here.

### Model Number Legend

G3VM-□□□□□  
1 2 3 4 5

#### 1. Load Voltage

- 2: 20 V
- 3: 30 V
- 4: 40 V
- 6: 60 V
- 10: 100 V
- 20: 200 V

#### 4. Additional functions

R: Low ON resistance

#### 2. Contact form

1: 1a (SPST-NO)

#### 3. Package

A: DIP 4-pin with PCB terminals  
D: DIP 4-pin with surface-mounting terminals

#### 5. Other informations

When specifications overlap, serial code is added in the recorded order.

### Ordering Information

Package	Contact form	Load voltage (peak value) *	Continuous load current (peak value) *	Stick packaging			Tape packaging	
				Model		Minimum package quantity	Model	Minimum package quantity
				PCB Terminals	Surface-mounting Terminals		Surface-mounting Terminals	
DIP4	1a (SPST-NO)	20 V	3 A	G3VM-21AR	G3VM-21DR	100 pcs.	G3VM-21DR(TR)	1,500 pcs.
		30 V	4 A	G3VM-31AR	G3VM-31DR		G3VM-31DR(TR05)	500 pcs.
		40 V	2.5 A	G3VM-41AR	G3VM-41DR		G3VM-41DR(TR)	1,500 pcs.
		60 V	2 A	G3VM-61AR	G3VM-61DR		G3VM-61DR(TR)	1,500 pcs.
			3 A	G3VM-61AR1	G3VM-61DR1		G3VM-61DR1(TR05)	500 pcs.
		100 V	1 A	G3VM-101AR	G3VM-101DR		G3VM-101DR(TR)	1,500 pcs.
			2 A	G3VM-101AR1	G3VM-101DR1		G3VM-101DR1(TR05)	500 pcs.
200 V	0.7 A	G3VM-201AR	G3VM-201DR	G3VM-201DR(TR05)	500 pcs.			

\* The AC peak and DC value are given for the load voltage and continuous load current.

Note: To order tape packaging for Relays with surface-mounting terminals, add "(TR)" or "(TR05)" to the end of the model number.

## ■ Absolute Maximum Ratings (Ta = 25°C)

Item	Symbol	G3VM-21AR	G3VM-31AR	G3VM-41AR	G3VM-61AR	G3VM-61AR1	G3VM-101AR	G3VM-101AR1	G3VM-201AR	Unit	Measurement conditions	
		G3VM-21DR	G3VM-31DR	G3VM-41DR	G3VM-61DR	G3VM-61DR1	G3VM-101DR	G3VM-101DR1	G3VM-201DR			
Input	LED forward current	30									mA	
	Repetitive peak LED forward current	1									A	100 μs pulses, 100 pps
	LED forward current reduction rate	-0.3									mA/°C	Ta ≥ 25°C
	LED reverse voltage	5	6	5	6	5	6	5	6	V		
	Connection temperature	125									°C	
Output	Load voltage (AC peak/DC)	20	30	40	60	60	100	100	200	V		
	Continuous load current (AC peak/DC)	3	4	2.5	2	3	1	2	0.7	A		
	ON current reduction rate	-30	-40	-25	-20	-30	-10	-20	-7	mA/°C	Ta ≥ 25°C	
	Pulse ON current	9	9	7.5	6	9	3	6	2.1	A	t=100 ms, Duty=1/10	
	Connection temperature	125									°C	
Dielectric strength between I/O *	V <sub>I-O</sub>	2,500									V <sub>rms</sub>	AC for 1 min
Ambient operating temperature	Ta	-40 to +85	-40 to +110	-40 to +85		-40 to +110	-40 to +85	-40 to +110		°C	With no icing or condensation	
Ambient storage temperature	Tstg	-55 to +125										°C
Soldering temperature	-	260									°C	10 s

\* The dielectric strength between the input and output was checked by applying voltage between all pins as a group on the LED side and all pins as a group on the light-receiving side.

DIP G3VM-□AR□/□DR□

## ■Electrical Characteristics (Ta = 25°C)

Item	Symbol		G3VM-21AR	G3VM-31AR	G3VM-41AR	G3VM-61AR	G3VM-61AR1	G3VM-101AR	G3VM-101AR1	G3VM-201AR	Unit	Measurement conditions	
			G3VM-21DR	G3VM-31DR	G3VM-41DR	G3VM-61DR	G3VM-61DR1	G3VM-101DR	G3VM-101DR1	G3VM-201DR			
LED forward voltage	V <sub>F</sub>	Minimum	1.18	1.5	1.18		1.5	1.18	1.5		V	I <sub>F</sub> =10 mA	
		Typical	1.33	1.64	1.33		1.64	1.33	1.64				
		Maximum	1.48	1.8	1.48		1.8	1.48	1.8				
Reverse current	I <sub>R</sub>	Maximum	10									μA	V <sub>R</sub> =5 V
Capacitance between terminals	C <sub>T</sub>	Typical	70									pF	V=0, f=1 MHz
Trigger LED forward current	I <sub>FT</sub> (I <sub>Fc</sub> )	Typical	0.7	0.3	0.5		0.3	0.5	0.4	0.3	mA	G3VM-201AR/201DR: I <sub>o</sub> =0.7A Others: I <sub>o</sub> =1A	
		Maximum	3										
Release LED forward current	I <sub>FC</sub> (I <sub>FT</sub> )	Minimum	0.1									mA	I <sub>OFF</sub> =10 μA
		Typical	0.1	0.2	0.1		0.2	0.1	0.2				
Maximum resistance with output ON	R <sub>ON</sub>	Typical	40	25	50	80	45	250	110	900	mΩ	G3VM-31AR/31DR I <sub>F</sub> =5mA, t<1s, I <sub>o</sub> =4A G3VM-61AR1/61DR1 I <sub>F</sub> =5mA, t<1s, I <sub>o</sub> =3A G3VM-21AR/21DR/ 41AR/41DR/61AR/ 61DR/101AR1/101DR1: I <sub>F</sub> =5mA, t<1s, I <sub>o</sub> =2A G3VM-101AR/101DR: I <sub>F</sub> =5mA, t<1s, I <sub>o</sub> =1A G3VM-201AR/201DR: I <sub>F</sub> =5mA, t<1s, I <sub>o</sub> =0.7A	
		Maximum	80	50	150	200	100	700	200	2000			
Current leakage when the relay is open	I <sub>LEAK</sub>	Typical	-	0.01	-		0.005	-	0.01	0.04	μA	V <sub>OFF</sub> =Load voltage ratings	
		Maximum	1										
Capacitance between terminals	C <sub>OFF</sub>	Typical	300	450	300	250		200	110		pF	V=0, f=1 MHz	
Capacitance between I/O terminals	C <sub>I-O</sub>	Typical	0.8									pF	f=1 MHz, V <sub>S</sub> =0 V
Insulation resistance between I/O terminals	R <sub>I-O</sub>	Minimum	1000									MΩ	V <sub>I-O</sub> =500 VDC, R <sub>oH</sub> ≤60%
		Typical	10 <sup>8</sup>										
Turn-ON time	t <sub>ON</sub>	Typical	1	0.6	0.8		0.45	0.8	0.4	0.13	ms	I <sub>F</sub> =5 mA, R <sub>L</sub> =200 Ω, V <sub>DD</sub> =20 V *	
		Maximum	5	3	5		2	5	2	1			
Turn-OFF time	t <sub>OFF</sub>	Typical	0.3			0.2		0.3	0.2	0.14	ms	I <sub>F</sub> =5 mA, R <sub>L</sub> =200 Ω, V <sub>DD</sub> =20 V *	
		Maximum	1			0.5		0.5					

\* Turn-ON and Turn-OFF Times

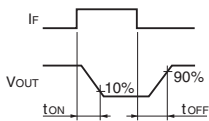
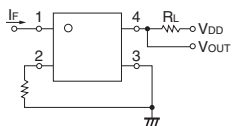

DIP

G3VM-□AR□/□DR□

## ■Recommended Operating Conditions

For usage with high reliability, Recommended Operation Conditions is a measure that takes into account the derating of Absolute Maximum Ratings and Electrical Characteristics.

Each item on this list is an independent condition, so it is not simultaneously satisfy several conditions.

Item	Symbol		G3VM-21AR	G3VM-31AR	G3VM-41AR	G3VM-61AR	G3VM-61AR1	G3VM-101AR	G3VM-101AR1	G3VM-201AR	Unit	
			G3VM-21DR	G3VM-31DR	G3VM-41DR	G3VM-61DR	G3VM-61DR1	G3VM-101DR	G3VM-101DR1	G3VM-201DR		
Load voltage (AC peak/DC)	V <sub>DD</sub>	Maximum	16	24	32	48		80		160	V	
		Minimum	5									mA
Operating LED forward current	I <sub>F</sub>	Typical	10									
		Maximum	25									
Continuous load current (AC peak/DC)	I <sub>o</sub>	Maximum	3	4	2.5	2	3	1	2	0.7	A	
Ambient operating temperature	T <sub>a</sub>	Minimum	-20									°C
		Maximum	65	85	65		85	65	85			

## ■Spacing and Insulation

Item	Minimum	Unit
Creepage distances	7.0	mm
Clearance distances	7.0	
Internal isolation thickness	0.4	

## Engineering Data

### LED forward current vs. Ambient temperature

G3VM-21AR/21DR/41AR/41DR/61AR/61DR/101AR/101DR

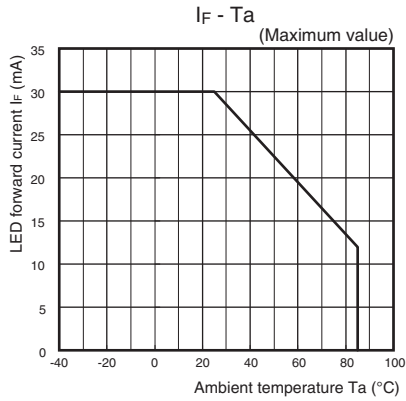

G3VM-31AR/31DR/61AR1/61DR1/101AR1/101DR1/201AR/201DR

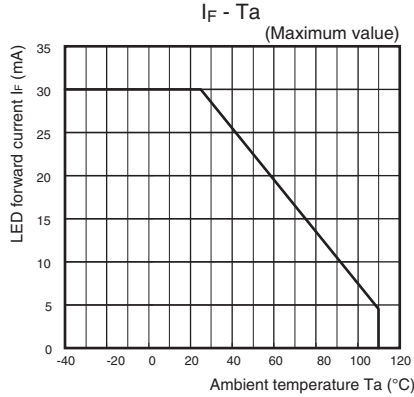

### Continuous load current vs. Ambient temperature

G3VM-21AR/21DR/41AR/41DR/61AR/61DR/101AR/101DR

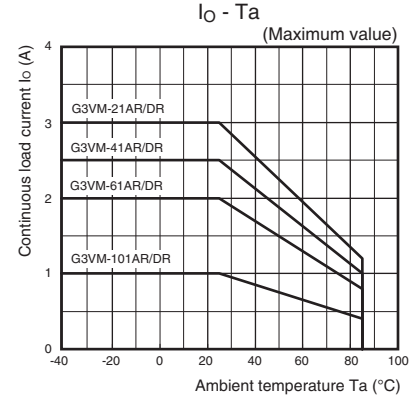

G3VM-31AR/31DR/61AR1/61DR1/101AR1/101DR1/201AR/201DR

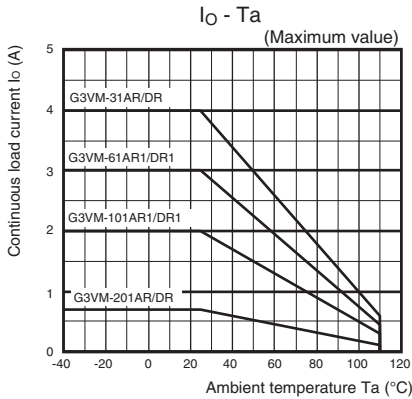

### LED forward current vs. LED forward voltage

G3VM-21AR/21DR/41AR/41DR/61AR/61DR/101AR/101DR

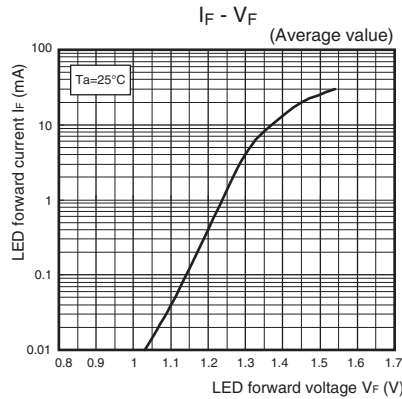

G3VM-31AR/31DR/61AR1/61DR1/101AR1/101DR1/201AR/201DR

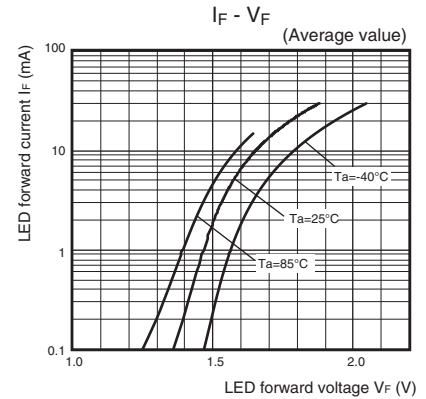

### Continuous load current vs. On-state voltage

G3VM-21AR/21DR/41AR/41DR/61AR/61DR/101AR/101DR

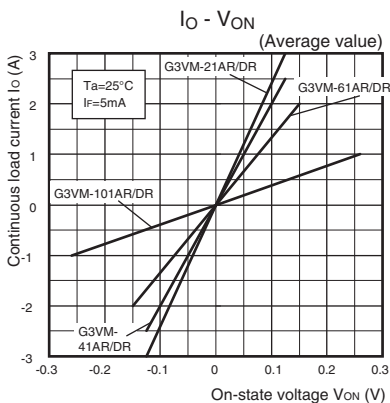

G3VM-31AR/31DR/61AR1/61DR1/101AR1/101DR1

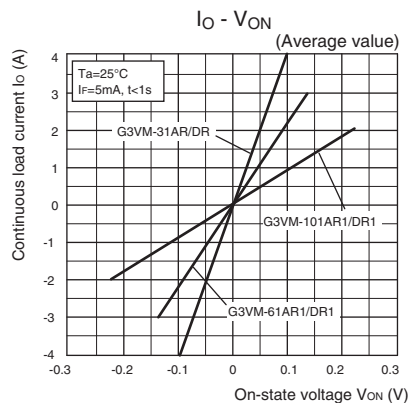

G3VM-201AR/201DR

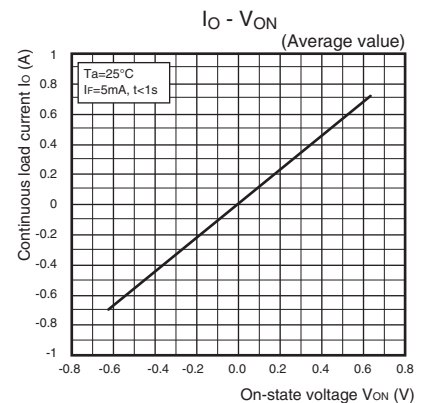

## Engineering Data

### On-state resistance vs. Ambient temperature

G3VM-21AR/21DR/41AR/41DR/61AR/61DR/101AR/101DR

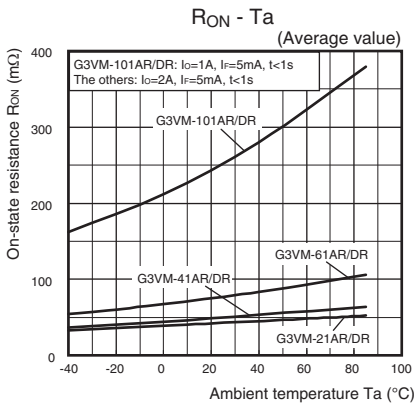

G3VM-31AR/31DR/61AR1/61DR1/101AR1/101DR1/201AR/201DR

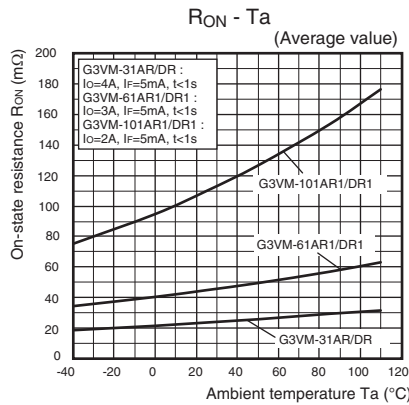

G3VM-201AR/201DR

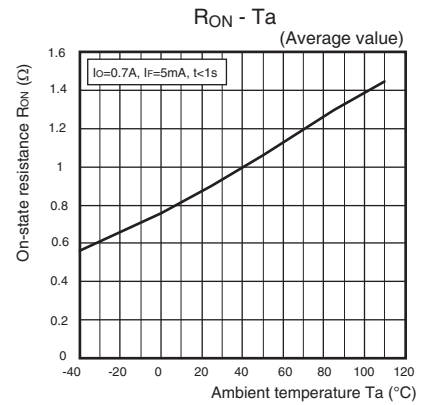

### Trigger LED forward current vs. Ambient temperature

G3VM-21AR/21DR/41AR/41DR/61AR/61DR/101AR/101DR

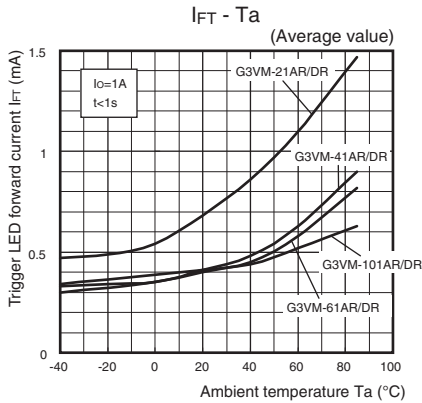

G3VM-31AR/31DR/61AR1/61DR1/101AR1/101DR1/201AR/201DR

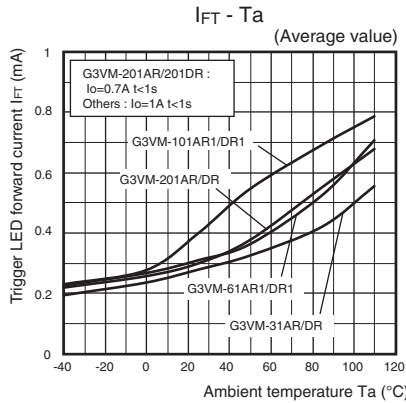

### Turn ON, Turn OFF time vs. LED forward current

G3VM-21AR/21DR/41AR/41DR

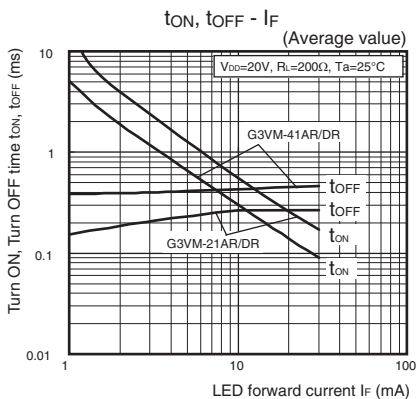

G3VM-61AR/61DR/101AR/101DR

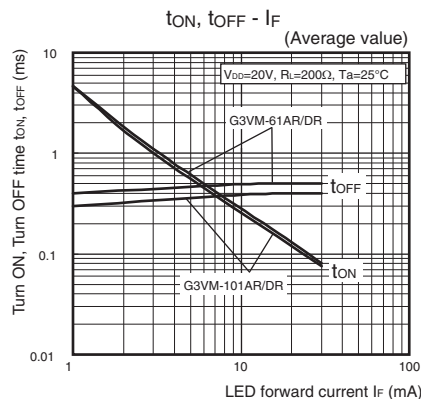

G3VM-31AR/31DR/61AR1/61DR1/101AR1/101DR1/201AR/201DR

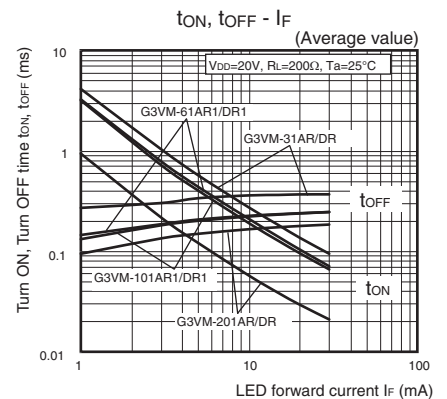

DIP G3VM-□AR□/□DR□

## Engineering Data

### ● Turn ON, Turn OFF time vs. Ambient temperature

G3VM-21AR/21DR/41AR/41DR

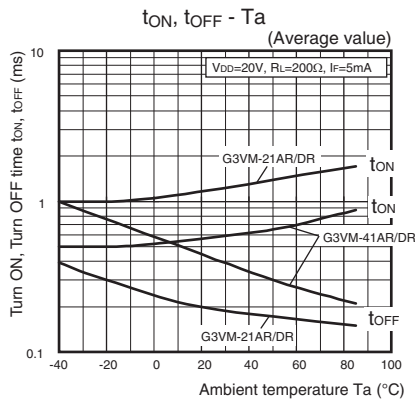

G3VM-61AR/61DR/101AR/101DR

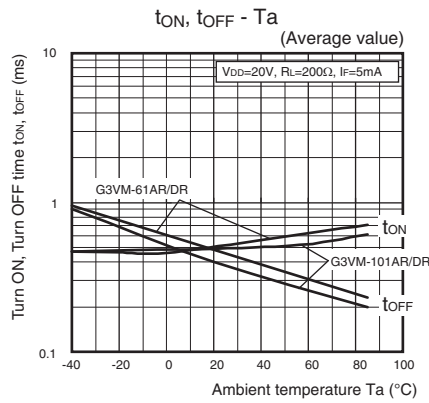

G3VM-31AR/31DR/61AR1/61DR1/101AR1/101DR1/201AR/201DR

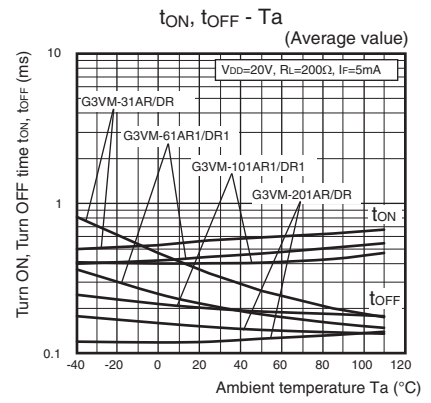

### ● Current leakage vs. Ambient temperature

G3VM-21AR/21DR/41AR/41DR/61AR/61DR/101AR/101DR

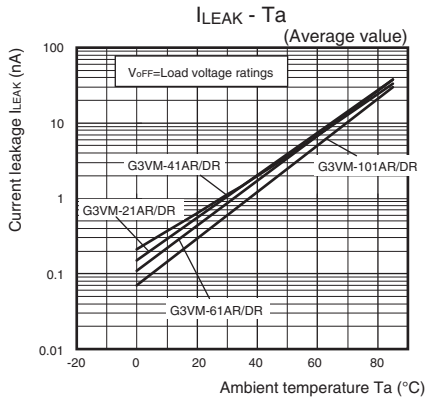

G3VM-31AR/31DR/61AR1/61DR1/101AR1/101DR1/201AR/201DR

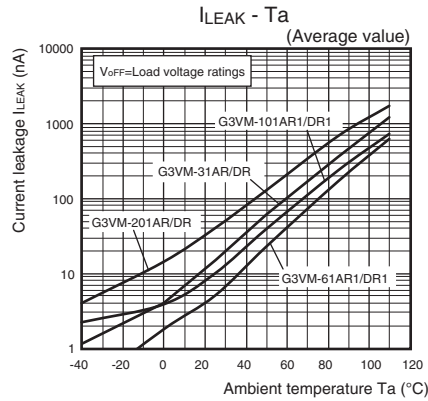

DIP

G3VM-□AR□/□DR□

## ■ Appearance / Terminal Arrangement / Internal Connections

### ● Appearance

#### DIP (Dual In-line Package)

DIP 4-pin

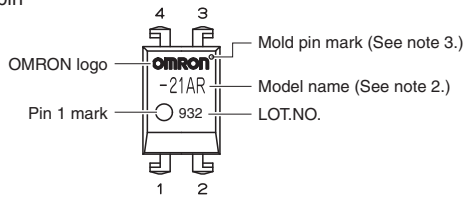

### ● Terminal Arrangement/Internal Connections (Top View)

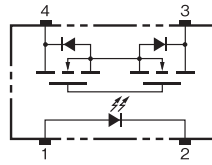

- Note: 1.** The actual product is marked differently from the image shown here.
- Note: 2.** "G3VM" does not appear in the model number on the Relay.
- Note: 3.** The indentation in the corner diagonally opposite from the pin 1 mark is from a pin on the mold.

### ■ Dimensions (Unit: mm)



#### PCB Terminals

Weight: 0.25 g

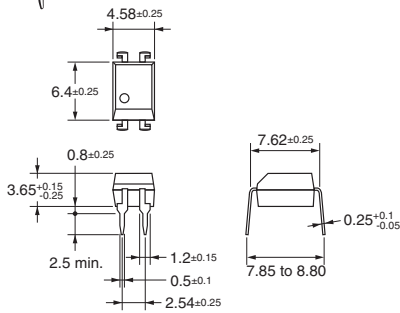

#### Surface-mounting Terminals

Weight: 0.25 g

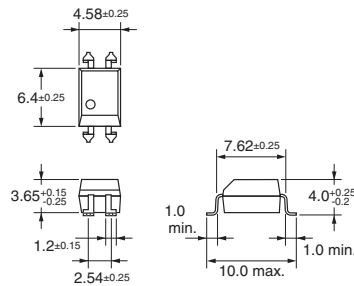

#### PCB Dimensions (BOTTOM VIEW)

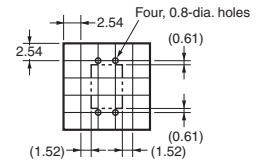

#### Actual Mounting Pad Dimensions

(Recommended Value, Top View)

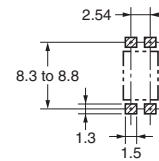

**Note:** The actual product is marked differently from the image shown here.

### ■ Approved Standards

UL recognized

Approved Standards	Contact form	File No.
UL (recognized)	1a (SPST-NO)	E80555

### ■ Safety Precautions

- Refer to the *Common Precautions for All MOS FET Relays* for precautions that apply to all MOS FET Relays.



Please check each region's Terms & Conditions by region website.

## OMRON Corporation

Electronic and Mechanical Components Company

### Regional Contact

**Americas**

<https://www.components.omron.com/>

**Asia-Pacific**

<https://ecb.omron.com.sg/>

**Korea**

<https://www.omron-ecb.co.kr/>

**Europe**

<http://components.omron.eu/>

**China**

<https://www.ecb.omron.com.cn/>

**Japan**

<https://www.omron.co.jp/ecb/>

## X-ON Electronics

Largest Supplier of Electrical and Electronic Components

*Click to view similar products for [Solid State Relays - PCB Mount](#) category:*

*Click to view products by [Omron](#) manufacturer:*

Other Similar products are found below :

[M86F-2W](#) [M90F-2Y](#) [G2-1A07-ST](#) [G2-1A07-TT](#) [G2-1B02-TT](#) [G2-DA06-ST](#) [923812OCAS](#) [PLA134S](#) [DS11-1005](#) [AQV210EHJ](#) [AQV212J](#)  
[AQV252GAJ](#) [AQY210ST](#) [AQY221N2SJ](#) [AQY221R2SJ](#) [AQY410SXJ](#) [AQY412EHAJ](#) [EFR1200480A150](#) [901-7](#) [LCA220](#) [LCB110S](#)  
[1618400-5](#) [SR75-1ST](#) [AQH2213AJ](#) [AQV112KLJ](#) [AQV212AJ](#) [AQV212SXJ](#) [AQV238AD01](#) [AQW414TS](#) [AQY221N2SYD01](#)  
[AQY221N2V1YJ](#) [AQY221N3VJ](#) [AQY221R2VJ](#) [AQY275AXJ](#) [AQY414SXE01](#) [G2-1A02-ST](#) [G2-1A03-ST](#) [G2-1A03-TT](#) [G2-1A05-ST](#) [G2-](#)  
[1A06-TT](#) [G2-1A23-TT](#) [G2-1B01-ST](#) [G2-1B01-TT](#) [G2-1B02-ST](#) [G2-DA03-ST](#) [G2-DA03-TT](#) [G2-DA06-TT](#) [CPC1333GR](#) [3-1617776-2](#)  
[CTA2425](#)