

MOS FET Relays G3VM-61LR

SSOP Package MOS FET Relay with Low Leakage Current, Output Capacitance and ON Resistance ($C \times R = 20 \text{ pF} \cdot \Omega$) in a 60-V Load Voltage Model.

- ON resistance of 1 Ω (typical) suppresses output signal attenuation.
- Leakage current of 0.04 nA (typ.) when relay is open
- RoHS compliant

Application Examples

- Semiconductor inspection tools
- Measurement devices and Data loggers
- Broadband systems



NEW

Note: The actual product is marked differently from the image shown here.

List of Models

Contact form	Terminals	Load voltage (peak value)	Model	Number per tape
SPST-NO	Surface-mounting terminals	60 VAC	G3VM-61LR	---
			G3VM-61LR(TR05)	500
			G3VM-61LR(TR)	1,500

Dimensions

Note: All units are in millimeters unless otherwise indicated.

G3VM-61LR

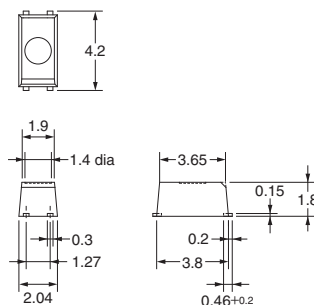
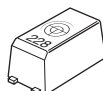

Note: The actual product is marked differently from the image shown here.

Note: A tolerance of ± 0.1 mm applies to all dimensions unless otherwise specified.

Weight: 0.03 g

Terminal Arrangement/Internal Connections (Top View)

G3VM-61LR

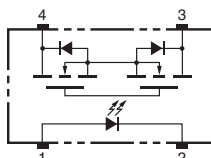

Actual Mounting Pad Dimensions (Recommended Value, Top View)

G3VM-61LR

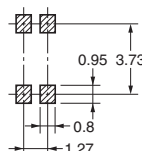

■ Absolute Maximum Ratings (Ta = 25°C)

Item	Symbol	Rating	Unit	Measurement Conditions	
Input	LED forward current	I_F	50	mA	
	LED forward current reduction rate	$\Delta I_F/^\circ\text{C}$	-0.5	mA/ $^\circ\text{C}$	$T_a \geq 25^\circ\text{C}$
	LED reverse voltage	V_R	5	V	
	Connection temperature	T_j	125	$^\circ\text{C}$	
Output	Load voltage (AC peak/DC)	V_{OFF}	60	V	
	Continuous load current	I_O	400	mA	
	ON current reduction rate	$\Delta I_{ON}/^\circ\text{C}$	-4.0	mA/ $^\circ\text{C}$	$T_a \geq 25^\circ\text{C}$
	Connection temperature	T_j	125	$^\circ\text{C}$	
Dielectric strength between input and output (See note 1.)		V_{I-O}	1,500	V_{rms}	AC for 1 min
Ambient operating temperature		T_a	-20 to +85	$^\circ\text{C}$	With no icing or condensation
Storage temperature		T_{stg}	-40 to +125	$^\circ\text{C}$	With no icing or condensation
Soldering temperature		---	260	$^\circ\text{C}$	10 s

Note: 1. The dielectric strength between the input and output was checked by applying voltage between all pins as a group on the LED side and all pins as a group on the light-receiving side.

■ Electrical Characteristics (Ta = 25°C)

Item	Symbol	Minimum	Typical	Maximum	Unit	Measurement conditions	
Input	LED forward voltage	V_F	1.0	1.15	1.3	V	$I_F = 10 \text{ mA}$
	Reverse current	I_R	---	---	10	μA	$V_R = 5 \text{ V}$
	Capacity between terminals	C_T	---	15	---	pF	$V = 0, f = 1 \text{ MHz}$
	Trigger LED forward current	I_{FT}	---	2	5	mA	$I_O = 100 \text{ mA}, R_{ON} < 1.5 \Omega$
Output	Maximum resistance with output ON	R_{ON}	---	1.0	1.5	Ω	$I_F = 5 \text{ mA}, I_O = 400 \text{ mA}$
	Current leakage when the relay is open	I_{LEAK}	---	0.04	1,000	nA	$V_{OFF} = 60 \text{ V}, T_a = 25^\circ\text{C}$
	Capacity between terminals	C_{OFF}	---	20	---	pF	$V = 0, f = 100 \text{ MHz}, t < 1 \text{ s}$
Capacity between I/O terminals		C_{I-O}	---	0.3	---	pF	$f = 1 \text{ MHz}, V_s = 0 \text{ V}$
Insulation resistance between I/O terminals		R_{I-O}	1,000	---	---	$\text{M}\Omega$	$V_{I-O} = 500 \text{ VDC}, R_{oh} \leq 60\%$
Turn-ON time		t_{ON}	---	0.3	1	ms	$I_F = 5 \text{ mA}, R_L = 200 \Omega, V_{DD} = 20 \text{ V}$ (See note 2.)
Turn-OFF time		t_{OFF}	---	0.2	1	ms	

Note: 2. Turn-ON and Turn-OFF Times

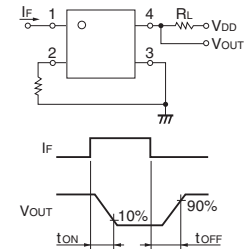

■ Recommended Operating Conditions

Use the G3VM under the following conditions so that the Relay will operate properly.

Item	Symbol	Minimum	Typical	Maximum	Unit
Load voltage (AC peak/DC)	V_{DD}	---	---	48	V
Operating LED forward current	I_F	10	---	20	mA
Continuous load current (AC peak/DC)	I_O	---	---	400	mA
Operating temperature	T_a	-20	---	70	$^\circ\text{C}$

■ Engineering Data

LED forward current vs. Ambient temperature
IF - Ta

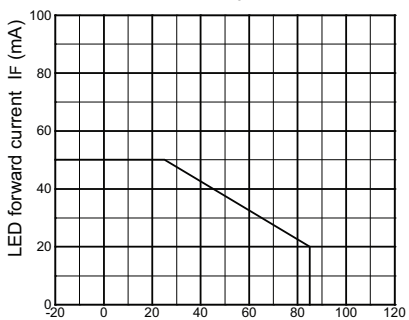

Ambient temperature Ta (°C)

Continuous load current vs. Ambient temperature
Io - Ta

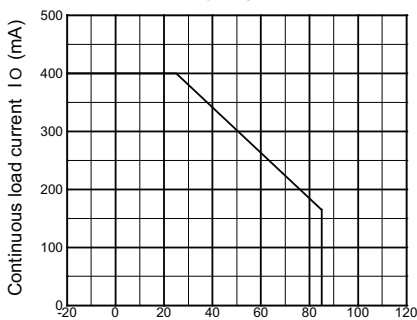

Ambient temperature Ta (°C)

LED forward current vs. LED forward voltage
IF - VF

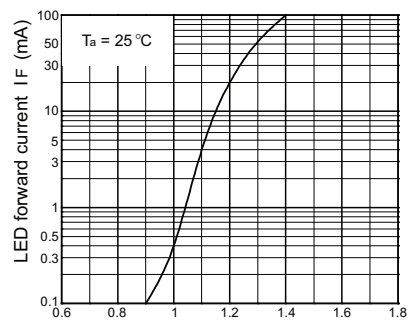

LED forward voltage VF (V)

Continuous load current vs. On-state voltage
Io - VON

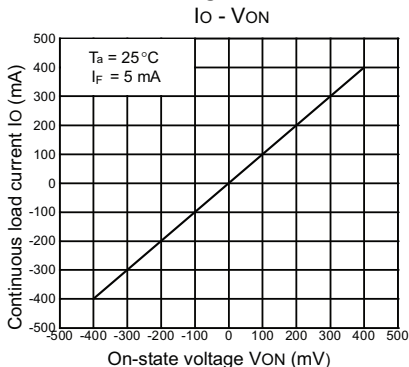

On-state voltage VON (mV)

On-state resistance vs. Ambient temperature
RON - Ta

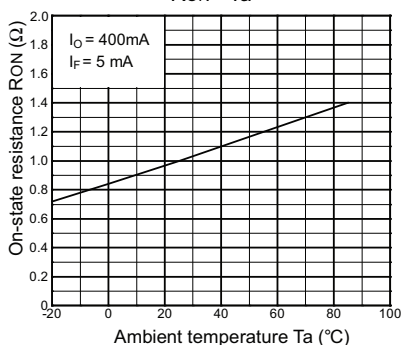

Ambient temperature Ta (°C)

Trigger LED forward current vs. Ambient temperature
IFT - Ta

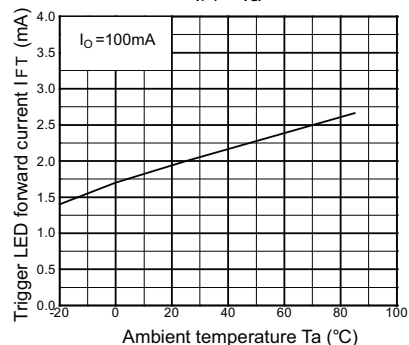

Ambient temperature Ta (°C)

Turn ON, Turn OFF time vs. LED forward current
tON, tOFF - IF

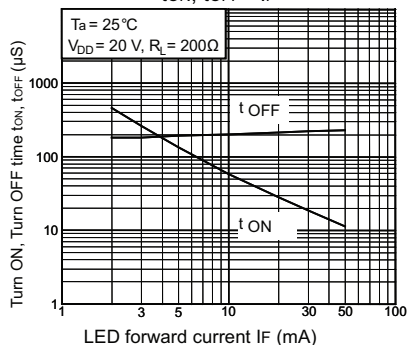

LED forward current IF (mA)

Turn ON, Turn OFF time vs. Ambient temperature
tON, tOFF - Ta

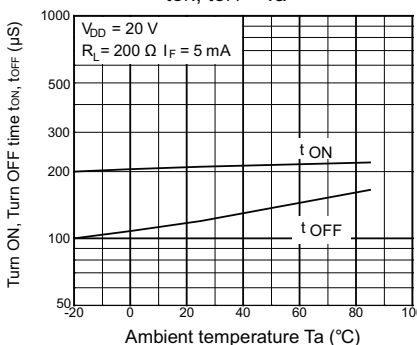

Ambient temperature Ta (°C)

Current leakage vs. Load voltage
ILEAK - VOFF

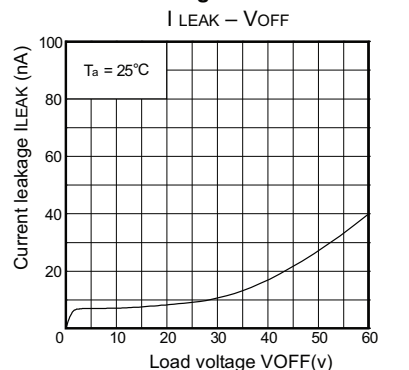

Load voltage VOFF (V)

Output terminal capacitance COFF/COFF(ov) vs. Load voltage
COFF - VOFF

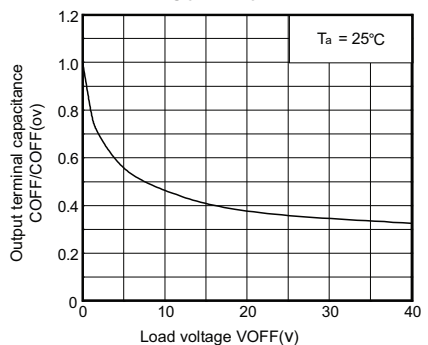

Load voltage VOFF (V)

All sales are subject to Omron Electronic Components LLC standard terms and conditions of sale, which can be found at http://www.components.omron.com/components/web/webfiles.nsf/sales_terms.html

ALL DIMENSIONS SHOWN ARE IN MILLIMETERS.

To convert millimeters into inches, multiply by 0.03937. To convert grams into ounces, multiply by 0.03527.

OMRON[®]

**OMRON ELECTRONIC
COMPONENTS LLC**

55 E. Commerce Drive, Suite B
Schaumburg, IL 60173

847-882-2288

OMRON ON-LINE

Global - <http://www.omron.com>

USA - <http://www.components.omron.com>

X-ON Electronics

Largest Supplier of Electrical and Electronic Components

Click to view similar products for [Solid State Relays - PCB Mount](#) category:

Click to view products by [Omron](#) manufacturer:

Other Similar products are found below :

[M86F-2W](#) [M90F-2Y](#) [G2-1A07-ST](#) [G2-1A07-TT](#) [G2-1B02-TT](#) [G2-DA06-ST](#) [923812OCAS](#) [PLA134S](#) [DS11-1005](#) [AQV212J](#)
[AQY412EHAJ](#) [EFR1200480A150](#) [901-7](#) [LCA220](#) [LCB110S](#) [1618400-5](#) [SR75-1ST](#) [AQH2213AJ](#) [AQV112KLJ](#) [AQV212AJ](#) [AQV212SXJ](#)
[AQV238AD01](#) [AQW414TS](#) [AQY221N2SYD01](#) [AQY221R2VJ](#) [AQY275AXJ](#) [AQY414SXE01](#) [G2-1A02-ST](#) [G2-1A03-ST](#) [G2-1A03-TT](#)
[G2-1A05-ST](#) [G2-1A06-TT](#) [G2-1A23-TT](#) [G2-1B01-ST](#) [G2-1B01-TT](#) [G2-1B02-ST](#) [G2-DA03-ST](#) [G2-DA03-TT](#) [G2-DA06-TT](#) [CPC1333GR](#)
[3-1617776-2](#) [CTA2425](#) [TLP3131\(F\)](#) [LBA110S](#) [LBB110S](#) [LCA110LSTR](#) [LCB126S](#) [WPPM-0626D](#) [WPPM-3526D](#) [WPPM-3588D](#)