

G5NB

PCB Power Relay

A Miniature Relay with 1-pole 3A/5A Switching Capability and 10 kV Impulse Withstand Voltage



- Highly efficient magnetic circuit for high sensitivity (200 mW).
- Small, yet provides 10-kV impulse withstand voltage (between coil and contacts).
- Standard model conforms to UL/CSA/VDE standards.
- Satisfies EN61010 reinforced insulation requirements.
- IEC/EN 60335-1 conformed. (-HA Model)
- IEC/EN 60079-15 conformed. (Only for G5NB-1A4, G5NB-1A4-E Model)

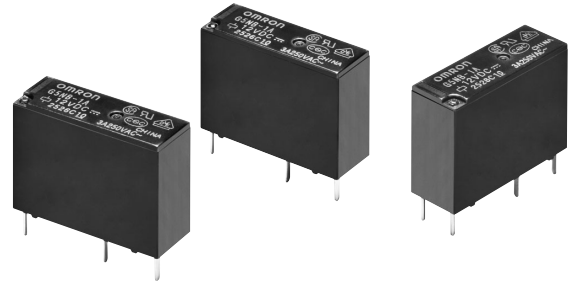

RoHS Compliant

Model Number Legend

G5NB-□□□-□-□-□-□-□
1 2 3 4 5 6 7 8

- | | | | |
|--|--|--|--|
| <p>1. Number of Poles
1 : 1-pole</p> <p>2. Contact Form
A : SPST-NO (1a)</p> <p>3. Enclosure rating
None : Flux protection
4 : Sealed</p> | <p>4. Classification
None : Standard
E : High-capacity</p> <p>5. Market Code
None : General purpose
HA : Home Appliance according to IEC/EN60335-1</p> | <p>6. Coil Insulation Class(UL1446)
None : Class B
CF : Class F</p> <p>7. Coil Holding Voltage
None : Not supported
PW : Supported</p> | <p>8. Packing
None : Tray Packing
SP : Tube Packing</p> |
|--|--|--|--|

Application Examples

- Water heaters
- Air conditioners
- Small electric appliances
- Refrigerators
- Home appliances

Ordering Information

Terminal Shape	Market Code	Classification	Contact form	Enclosure rating	Model	Rated coil voltage	Minimum packing unit
PCB terminals	General purpose	Standard	SPST-NO (1a)	Flux protection	G5NB-1A(-SP)	5VDC 12VDC	100 pcs/Tray (50 pcs/Tube)
				Sealed	G5NB-1A4(-SP)	18VDC 24VDC	
				Flux protection	G5NB-1A-CF(-SP)	5VDC 12VDC 24VDC	
		G5NB-1A-CF-PW(-SP)					
		G5NB-1A-PW(-SP)					
		High-capacity		G5NB-1A-E(-SP)	5VDC 12VDC 18VDC 24VDC		
	Sealed		G5NB-1A4-E(-SP)	18VDC 24VDC			
	Home Appliance		Standard	Flux protection	G5NB-1A-HA(-SP)	5VDC 12VDC 24VDC	
		G5NB-1A-HA-CF(-SP)					
		G5NB-1A-HA-CF-PW(-SP)					
		G5NB-1A-HA-PW	12VDC 24VDC				
		High-capacity			G5NB-1A-E-HA(-SP)		

Note 1. When ordering, add the rated coil voltage to the model number.

Example: G5NB-1A DC5

Rated coil voltage

However, the notation of the coil voltage on the product case as well as on the packing will be marked as □□VDC.

Note 2. When ordering tape packing, add "-SP" to the model number.

Be sure since "-SP" is not part of the relay model number, it is not marked on the relay case.

■ Ratings

● Coil

Item	Rated current (mA)	Coil resistance (Ω)	Must operate voltage (V)	Must release voltage (V)	Max. voltage (V)	Power consumption (mW)
			% of rated voltage			
Rated voltage						
5 VDC	40	125	75% max.	10% min. 10 to 31%*	Standard: 180% (at 23°C) High-capacity: 170% (at 23°C)	Approx. 200 Approx. 32*
12 VDC	16.7	720				
18 VDC	11.1	1,620				
24 VDC	8.3	2,880				

Note 1. The rated current and coil resistance are measured at a coil temperature of 23°C with a tolerance of ±10%.

Note 2. The operating characteristics are measured at a coil temperature of 23°C.

Note 3. The "Max. voltage" is the maximum voltage that can be applied to the relay coil.

* These numbers are only for -PW type. Power consumption with Holding Voltage is 32mW. Please confirm the detail in page 6 Coil Voltage Reduction (Holding Voltage).

● Contacts

Item	Load	Resistive load	
		Standard	High-capacity
Contact Type		Single	
Contact material		Ag-alloy (Cd free)	
Rated load		3 A at 125 VAC	5 A at 250 VAC
		3 A at 30 VDC	3 A at 30 VDC
Rated carry current		3 A	5 A
Max. switching voltage		250 VAC, 30 VDC	
Max. switching current		3 A	5 A

■ Characteristics

Contact resistance *1	100 mΩ max.	
Operate time	10 ms max.	
Release time	10 ms max.	
Insulation resistance *2	1,000 MΩ min.	
Dielectric strength	Between coil and contacts	4,000 VAC, 50/60 Hz for 1 min
	Between contacts of the same polarity	750 VAC, 50/60 Hz for 1 min
Impulse withstand voltage	Between coil and contacts	10 kV (1.2 × 50 μs)
Vibration resistance	Destruction	10 to 55 to 10 Hz, 0.75 mm single amplitude (1.5 mm double amplitude)
	Malfunction	10 to 55 to 10 Hz, 0.75 mm single amplitude (1.5 mm double amplitude)
Shock resistance	Destruction	1,000 m/s ²
	Malfunction	100 m/s ²
Durability	Mechanical	5,000,000 operations min.
	Electrical (resistive load)	Standard (G5NB-1A, -1A4) 200,000 operations at 125 VAC, 3A 200,000 operations at 30 VDC, 3A High-capacity (G5NB-1A-E, -1A4-E) 100,000 operations at 250 VAC, 5A 200,000 operations at 30 VDC, 3A (with a rated load at 1,800 operations/hour)
Failure rate (P level) (reference value) *3	DC5V 10mA	
Ambient operating temperature *4	-40°C to 85°C (with no icing or condensation)	
Ambient operating humidity	5% to 85%	
Weight	Approx. 4 g	

Note. Values in the above table are the initial values at 23°C.

*1. Measurement conditions: 5 VDC, 1 A, voltage drop method

*2. Measurement conditions: Measured at the same points as the dielectric strength using a 500 VDC ohmmeter.

*3. This value was measured at a switching frequency of 120 operations/min.

*4. Sealed (G5NB-1A4, -1A4-E): -40°C to 70°C

■ Actual Load Life (Reference Values)

- 120 VAC** motor and lamp load
2.5A surge and 0.5A normal:
250,000 operations min. (at 23°C)
- 160 VDC** valve load (with varistor)
0.24A:
250,000 operations min. (at 23°C)
- 140 VAC** pump load
Inrush: 5.4 A (o-p), Steady state: 1.6 A
200,000 operations min. (Ambient temperature: 23°C)
- 100 VAC** motor load
Inrush: 10.7 A (o-p), Steady state: 1.1 A
200,000 operations min. (Ambient temperature: 23°C)

Engineering Data

Maximum Switching Capacity

Standard models

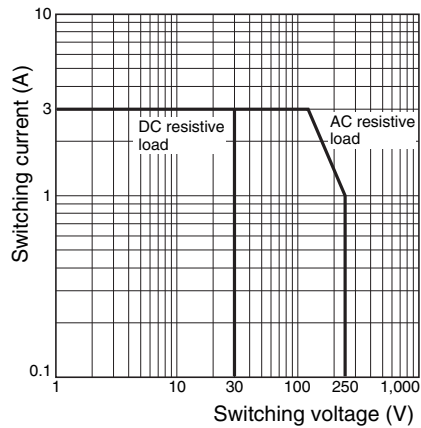

High-capacity models

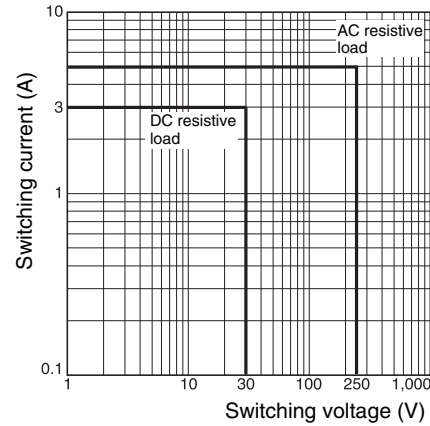

Durability

Standard models

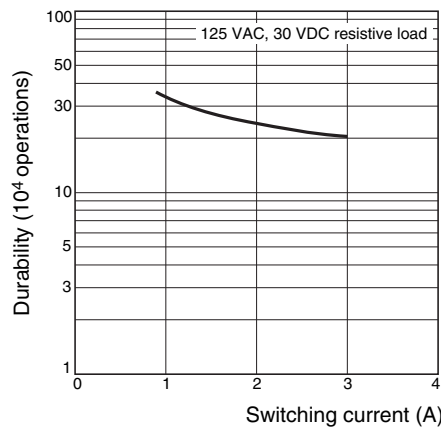

High-capacity models

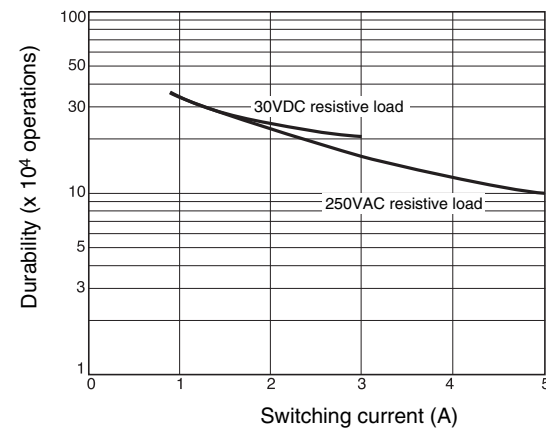

Ambient Temperature vs. Maximum Coil Voltage

Standard models

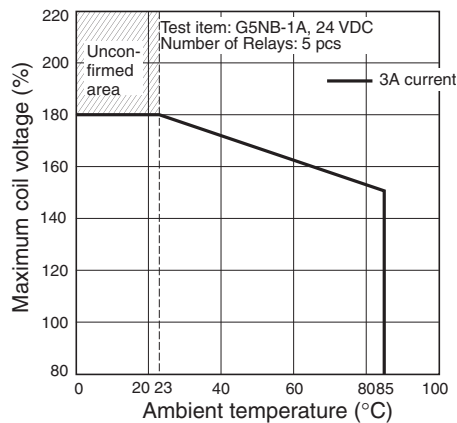

High-capacity models

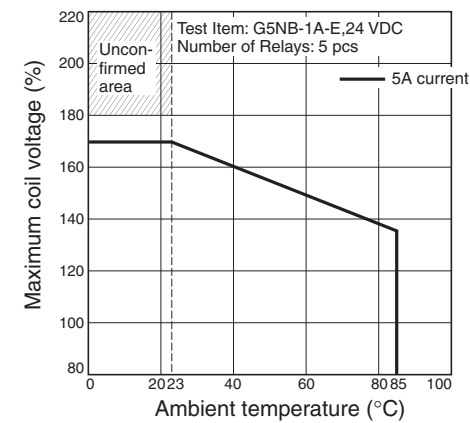

Note: The maximum coil voltage refers to the maximum value in a varying range of operating power voltage, not a continuous voltage.

● Shock malfunction

Standard models

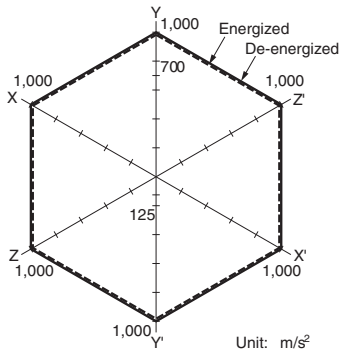

Test Item: G5NB-1A, 24VDC
 Number of Relays: 5 pcs
 Test Method: Shock is applied 3 times in 6 directions along 3 axes and the level at which shock caused malfunction is measured.
 The energized voltage is 100% of the rated voltage.
 Rating: 100 m/s²

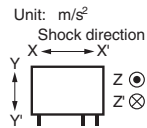

High-capacity models

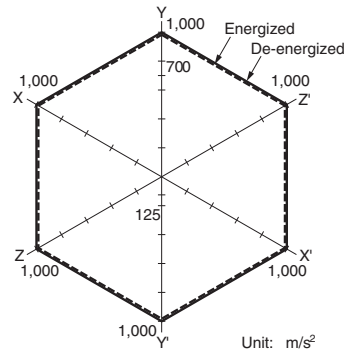

Test Item: G5NB-1A-E, 24VDC
 Number of Relays: 5 pcs
 Test Method: Shock is applied 3 times in 6 directions along 3 axes and the level at which shock caused malfunction is measured.
 The energized voltage is 100% of the rated voltage.
 Rating: 100 m/s²

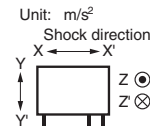

■ Dimensions

(Unit: mm)

G5NB

G5NB-1A(4)(-E)(-HA)(-CF)(-PW)

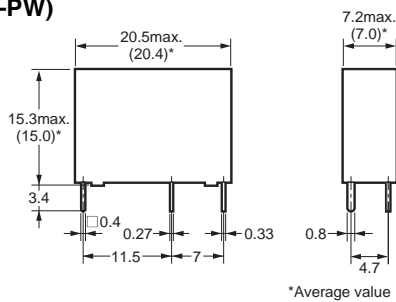
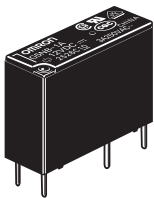

PCB Mounting Holes (Bottom View)

Tolerance: ±0.1 mm

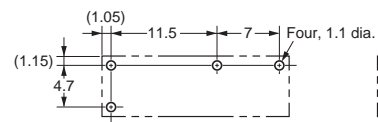

Terminal Arrangement/ Internal Connections (Bottom View)

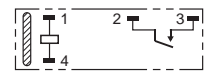

(No coil polarity)

Approved Standards

The approval rating values for overseas standards are different from the performance values determined individually. Confirm the values before use.

●UL Recognized:  (File No. E41515)

CSA Certified:  (File No. LR31928)

Model	Contact form	Coil ratings	Contact ratings	Number of test operations
G5NB-1A(4)(-HA)(-CF)(-PW)	SPST-NO (1a)	5 to 24V DC	3A 250V AC (Resistive) 85°C	100,000
			3A 30V DC (Resistive) 70°C	6,000
G5NB-1A(4)-E G5NB-1A-E-HA			5A 250 V AC (Resistive) 85°C 5A 30 V DC (Resistive) 70°C	6,000

●EN/IEC, VDE Certified  (Certificate No. 137575)

Model	Contact form	Coil ratings	Contact ratings	Number of test operations
G5NB-1A(4)(-HA)(-CF)(-PW)	SPST-NO (1a)	5, 12, 18, 24V DC	3A 250V AC (Resistive) 85°C 3A 30V DC (Resistive) 85°C	100,000
G5NB-1A(4)-E G5NB-1A-E-HA			5A 250 V AC (Resistive) 85°C 5A 30 V DC (Resistive) 85°C	10,000
			3A 250V AC (Resistive) 85°C	100,000

Creepage distance	6.0 mm min.
Clearance distance	6.0 mm min.
Insulation material group	IIIa
Type of insulation coil-contact circuit open contact circuit	Pollution degree 2 / Reinforced (Sealed) Pollution degree 3 / Basic (Flux protection) / Reinforced (Sealed) Micro disconnection
Rated Insulation voltage	250 V
Pollution degree	3
Rated voltage system	250 V
Over voltage category	III
Category of protection according to IEC 61810-1	RT II (Flux protection) / RT III (Sealed)
Glow wire according to IEC 60335-1	<HA Models only> GWT 750°C min. (IEC 60695-2-11) / GWF1 850°C min. (IEC 60695-2-12)
Tracking resistance according to IEC 60112	PTI 250 V min. (housing parts)
Flammability class according to UL94	V-0

■Precautions

●Please refer to “PCB Relays Common Precautions” for correct use.

Correct Use

●Coil Voltage Reduction (Holding Voltage) after Relay Operation

- If the coil voltage is reduced to the holding voltage after Relay operation, first apply the rated voltage to the coil for at least 100 ms, as shown below.
- A voltage of at least 40% of the rated voltage is required for the coil holding voltage. Do not allow voltage fluctuations to cause the coil holding voltage to fall below this level.

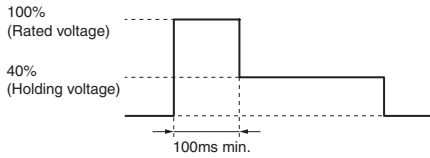

	Applied coil voltage	Coil resistance*	Power consumption
Rated voltage	100%	125Ω (5 VDC) 720Ω (12 VDC)	Approx. 200 mW
Holding voltage	40%	2880Ω (24 VDC)	Approx. 32 mW

* The coil resistance were measured at a coil temperature of 23°C with tolerances of ± 10%.

Please check each region's Terms & Conditions by region website.

OMRON Corporation

Electronic and Mechanical Components Company

Regional Contact

Americas
<https://www.components.omron.com/>

Asia-Pacific
<https://ecb.omron.com.sg/>

Korea
<https://www.omron-ecb.co.kr/>

Europe
<http://components.omron.eu/>

China
<https://www.ecb.omron.com.cn/>

Japan
<https://www.omron.co.jp/ecb/>

X-ON Electronics

Largest Supplier of Electrical and Electronic Components

Click to view similar products for [General Purpose Relays](#) category:

Click to view products by [Omron](#) manufacturer:

Other Similar products are found below :

[APF30318](#) [JVN1AF-4.5V-F](#) [PCN-105D3MHZ](#) [5JO-10000S-SIL](#) [5JO-1000CD-SIL](#) [5JO-400CD-SIL](#) [LY2S-AC220/240](#) [LYQ20DC12](#)
[6031007G](#) [6131406HQ](#) [6-1393099-3](#) [6-1393099-8](#) [6-1393122-4](#) [6-1393123-2](#) [6-1393767-1](#) [6-1393843-7](#) [6-1415012-1](#) [6-1419102-2](#) [6-](#)
[1423698-4](#) [6-1608051-6](#) [6-1608067-0](#) [6-1616170-6](#) [6-1616248-2](#) [6-1616282-3](#) [6-1616348-2](#) [6-1616350-1](#) [6-1616350-8](#) [6-1616358-7](#) [6-](#)
[1616359-9](#) [6-1616360-9](#) [6-1616931-6](#) [6-1617039-1](#) [6-1617052-1](#) [6-1617090-2](#) [6-1617090-5](#) [6-1617347-5](#) [6-1617353-3](#) [6-1617801-8](#) [6-](#)
[1617802-2](#) [6-1618107-9](#) [6-1618248-4](#) [M83536/1-027M](#) [CX-4014](#) [MAHC-5494](#) [MAVCD-5419-6](#) [703XCX-120A](#) [7-1393100-5](#) [7-1393111-7](#)
[7-1393144-5](#) [7-1393767-8](#)