

G5RL

PCB Power Relay

Low-profile Relay with Various Models

- Low profile: 15.7 mm in height.
- Creepage distance 8mm between coil and contacts
- 10 kV Impulse withstand voltage
- Models with AC coil available.
- High-Inrush model available (Inrush peak currents up to 100 A)
- Low Noise models available (Approx. 10 to 20 dB less sound pressure than standard G5RL-Series Relays)
- TV8 Rating models available (TV8 for UL standard)



RoHS Compliant

Model Number Legend

G5RL-□□-□-□
1 2 3 4

1. Number of poles

1: 1-pole

3. Classification

None: Standard

E : High-capacity

2. Contact Form

None: SPDT (1c)

A : SPST-NO (1a)

4. Additional Models

None: Standard

HR: High-inrush

LN: Low Noise

TV8: TV8 rating

Application Examples

- Housing equipments
- Audio-visual products
- Office automation machines
- Air-conditioners
- Lighting

G
5
R
L

Ordering Information

Classification	Terminal Shape	Contact form	Enclosure rating	Model	Rated coil voltage	Minimum packing unit
Standard	PCB terminals	SPST-NO (1a)	Flux protection	G5RL-1A-LN	5VDC, 12VDC, 24VDC	100 pcs/tray
High-capacity				G5RL-1A-TV8	5VDC, 12VDC, 24VDC, 48VDC	
				G5RL-1A-E-HR	5VDC, 12VDC, 24VDC, 48VDC	
				G5RL-1A-E-LN	5VDC, 12VDC, 24VDC	
				G5RL-1A-E-TV8	5VDC, 12VDC, 24VDC, 48VDC	
				G5RL-1-E	24VAC, 100VAC, 115VAC/120VAC, 200VAC, 230VAC/240VAC	
		G5RL-1-E-HR		5VDC, 12VDC, 24VDC, 48VDC		
		SPDT (1c)				

Note. When ordering, add the rated coil voltage to the model number.

Example: G5RL-1A-LN DC5

Rated coil voltage

However, the notation of the coil voltage on the product case as well as on the packing will be marked as □□ VDC.

Ratings

Coil

Low Noise Models: G5RL-1A(-E)-LN

Rated Voltage (VDC)	Rated current (mA)	Coil resistance (Ω)	Must operate voltage (V)	Must release voltage (V)	Max voltage (V)	Power consumption (mW)
			% of rated voltage			
5	106	47.2	70% max.	10% min.	110%	Approx. 530
12	44.2	272				
24	22.1	1,086				

Note 1. The rated current and coil resistance are measured at a coil temperature of 23°C with a tolerance of ±10%.

2. Be sure to use a diode for surge absorption for the coil.

3. The operating characteristics are measured at a coil temperature of 23°C.

4. The "Max. voltage" is the maximum voltage that can be applied to the relay coil.

High-Inrush Models: G5RL-1(A)-E-HR, G5RL-1A(-E)-TV8

Rated Voltage (VDC)	Rated current (mA)	Coil resistance (Ω)	Must operate voltage (V)	Must release voltage (V)	Max. voltage (V)	Power consumption (mW)
			% of rated voltage			
5	80	62.5	70% max.	10% min.	130%	Approx. 400
12	33.3	360				
24	16.7	1,440				
48	8.96	5,358				

- Note 1. The rated current and coil resistance are measured at a coil temperature of 23°C with a tolerance of ±10%.
 2. The operating characteristics are measured at a coil temperature of 23°C.
 3. The "Max. voltage" is the maximum voltage that can be applied to the relay coil.

Models with AC Coil: G5RL-1-E

Rated Voltage (VAC)	Rated current at 50Hz (mA)	Rated current at 60Hz (mA)	Coil resistance (Ω)	Must operate voltage (V)	Must release voltage (V)	Max. voltage (V)	Power consumption (mW)
				% of rated voltage			
24	31.3	28.3	443	75% max.	15% min.	110%	Approx. 750
100	7.5	6.88	8,220				
115/120	5.85/6.25	5.35/5.70	11,600				
200	3.75	3.45	33,000				
230/240	3.00/3.13	2.76/2.88	47,600				

- Note 1. The rated current tolerance is +15%/-20%.
 2. The operating characteristics are measured at a coil temperature of 23°C.
 3. Coil resistances are provided as reference values.
 4. The "Max. voltage" is the maximum voltage that can be applied to the relay coil.

●Contacts

Low Noise Models: G5RL-1A(-E)-LN

Load	Resistive load	
	Standard	High-capacity
Contact form	SPST-NO (1a)	
Contact Type	Single	
Contact material	Ag Alloy	
Rated load	12 A at 250 VAC 12 A at 24 VDC	16 A at 250 VAC 16 A at 24 VDC
Rated carry current	12 A	16 A
Max. switching voltage	250 VAC, 24 VDC	
Max. switching current	12 A	16 A

High-Inrush Models: G5RL-1(A)-E-HR, G5RL-1A(-E)-TV8

Load	Resistive load		
	Standard	High-capacity	
Contact form	SPST-NO (1a)	SPST-NO (1a)	SPDT (1c)
Contact Type	Single		
Contact material	Ag Alloy		
Rated load	12 A at 250 VAC 12 A at 24 VDC	16 A at 250 VAC 16 A at 24 VDC	16 A at 250 VAC, 24VDC (NO) 5 A at 250 VAC, 24 VDC (NC)
Rated carry current	12 A	16 A	16 A (NO), 5 A (NC)
Max. switching voltage	250 VAC, 24 VDC		
Max. switching current	12 A	16 A	16 A (NO), 5 A (NC)

Models with AC Coil: G5RL-1-E

Load	Resistive load	
	High-capacity	
Contact form	SPDT (1c)	
Contact Type	Single	
Contact material	Ag Alloy	
Rated load	16 A at 250 VAC, 24 VDC (NO) 5 A at 250 VAC, 24 VDC (NC)	
Rated carry current	16 A (NO), 5 A (NC)	
Max. switching voltage	250 VAC, 24 VDC	
Max. switching current	16 A (NO), 5 A (NC)	

■ Characteristics

● Low Noise Models: G5RL-1A(-E)-LN

Item	Classification	Standard	High-capacity
Contact resistance		100 mΩ max.	
Operate time		15 ms max.	
Release time		15 ms max.	
Insulation resistance		1,000 MΩ min.	
Dielectric strength	Between coil and contacts	6,000 VAC, 50/60 Hz for 1 min	
	Between contacts of the same polarity	1,000 VAC, 50/60 Hz for 1 min	
Impulse withstand voltage	Between coil and contacts	10 kV (1.2 × 50 μs)	
Insulation distance	Between coil and contacts	Clearance: 8 mm, Creepage: 8 mm	
Vibration resistance	Destruction	10 to 55 to 10 Hz, 0.75 mm single amplitude (1.5 mm double amplitude)	
	Malfunction	10 to 55 to 10 Hz, 0.75 mm single amplitude (1.5 mm double amplitude)	
Shock resistance	Destruction	1,000 m/s ²	
	Malfunction	100 m/s ²	
Durability	Mechanical	1,000,000 operation min. (at 18,000 operations/hr)	
	Electrical	100,000 operations min. (at 1,800 operations/hr) 50,000 operations min. (at 1,800 operations/hr)	
Failure rate (P level) (reference)		100 mA at 5 VDC	
Ambient operating temperature		-40°C to 85°C (with no icing or condensation)	
Ambient operating humidity		5% to 85%	
Weight		Approx. 10 g	

Note 1. Values in the above table are initial values.

2. The contact resistance is measured with 1 A applied at 5 VDC using a fall-of-potential method.

3. The insulation resistance is measured between coil and contacts and between contacts of the same polarity at 500 VDC.

4. The release time is value with a diode attached.

5. Failure rate (P level) was measured at a switching frequency of 120 operations/min.

● High-Inrush Models: G5RL-1(A)-E-HR, G5RL-1A(-E)-TV8

Item	Classification	Standard	High-capacity
Contact resistance		100 mΩ max.	
Operate time		15 ms max.	
Release time		5 ms max.	
Insulation resistance		1,000 MΩ min. (at 500 VDC)	
Dielectric strength	Between coil and contacts	6,000 VAC, 50/60 Hz for 1 min	
	Between contacts of the same polarity	1,000 VAC, 50/60 Hz for 1 min	
Impulse withstand voltage	Between coil and contacts	10 kV (1.2 × 50 μs)	
Insulation distance	Between coil and contacts	Clearance: 8 mm, Creepage: 8 mm	
Vibration resistance	Destruction	10 to 55 to 10 Hz, 0.75 mm single amplitude (1.5 mm double amplitude)	
	Malfunction	10 to 55 to 10 Hz, 0.75 mm single amplitude (1.5 mm double amplitude)	
Shock resistance	Destruction	1,000 m/s ²	
	Malfunction	100 m/s ²	
Durability	Mechanical	10,000,000 operation min. (at 18,000 operations/hr)	
	Electrical	100,000 operations min. (at 1,800 operations/hr) 50,000 operations min. (at 1,800 operations/hr)	
Failure rate (P level) (reference)		100 mA at 5 VDC	
Ambient operating temperature		-40°C to 85°C (with no icing or condensation)	
Ambient operating humidity		5% to 85%	
Weight		Approx. 10 g	

Note 1. Values in the above table are initial values.

2. The contact resistance is measured with 1 A applied at 5 VDC using voltage drop method.

3. The insulation resistance is measured between coil and contacts and between contacts of the same polarity at 500 VDC.

4. The resistive load ratings for NO contact apply when there is no load on NC contact.

5. Failure rate (P level) was measured at a switching frequency of 120 operations/min.

● Models with AC Coil: G5RL-1-E

Item	Classification	High-capacity
Contact resistance		100 mΩ max.
Operate time		20 ms max.
Release time		20 ms max.
Insulation resistance		1,000 MΩ min. (at 500 VDC)
Dielectric strength	Between coil and contacts	6,000 VAC, 50/60 Hz for 1 min
	Between contacts of the same polarity	1,000 VAC, 50/60 Hz for 1 min
Impulse withstand voltage	Between coil and contacts	10 kV (1.2 × 50 μs)
Insulation distance	Between coil and contacts	Clearance: 8 mm, Creepage: 8 mm
Vibration resistance	Destruction	10 to 55 to 10 Hz, 0.75 mm single amplitude (1.5 mm double amplitude)
	Malfunction	10 to 55 to 10 Hz, 0.75 mm single amplitude (1.5 mm double amplitude)
Shock resistance	Destruction	1,000 m/s ²
	Malfunction	100 m/s ²
Durability	Mechanical	10,000,000 operation min. (at 18,000 operations/hr)
	Electrical	50,000 operations min. (at 720 operations/hr)
Failure rate (P level) (reference)		40 mA at 24 VDC
Ambient operating temperature		-40°C to 70°C (with no icing or condensation)
Ambient operating humidity		5% to 85%
Weight		Approx. 10 g

Note 1. Values in the above table are initial values.

2. The contact resistance is measured with 1 A applied at 5 VDC using voltage drop method.

3. The insulation resistance is measured between coil and contacts and between contacts of the same polarity at 500 VDC.

4. The resistive load ratings for NO contact apply when there is no load on NC contact.

5. Failure rate (P level) was measured at a switching frequency of 120 operations/min.

Engineering Data

Low Noise Models: G5RL-1A(-E)-LN

Maximum Switching Capacity

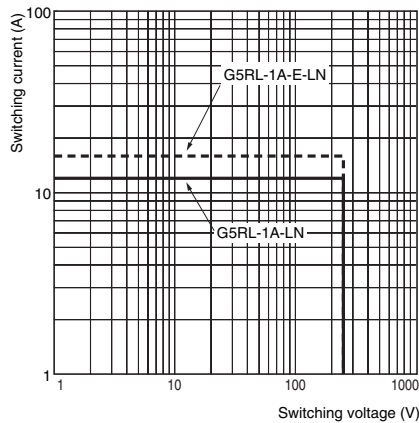

Durability

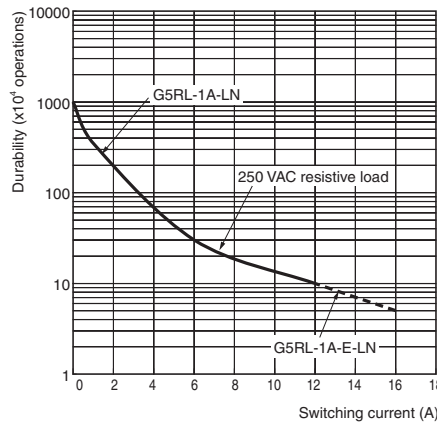

Distribution of Sound Pressure

1. When Operating

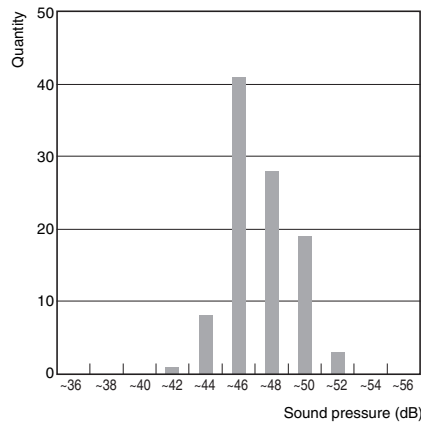

2. When Releasing

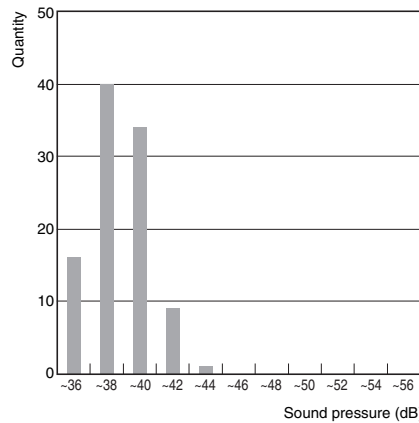

Sample: G5RL-1A-LN 12 VDC
 Number of relays: 100 pcs
 Range: A weighted sound pressure level,
 Fast, Max. hold
 Device connected to coil: Diode
 Testing environment: Room temperature and
 humidity
 Background noise: Approx. 30 dB max.

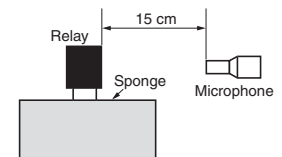

High-Inrush Models : G5RL-1(A)-E-HR, G5RL-1A(-E)-TV8

Models with AC Coil : G5RL-1-E

Maximum Switching Capacity

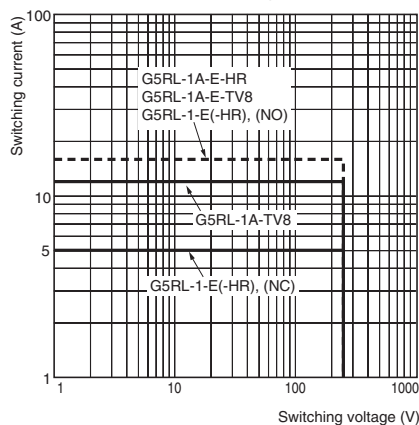

Durability

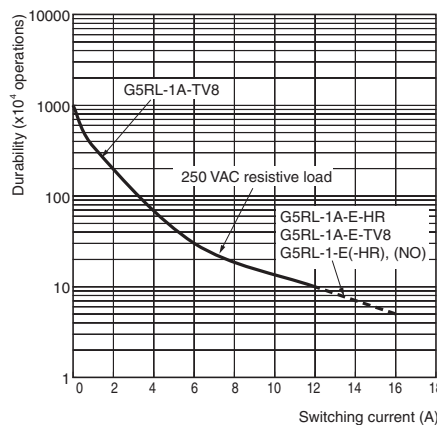

■Dimensions

(Unit: mm)

G5RL-1A-LN
G5RL-1A-TV8

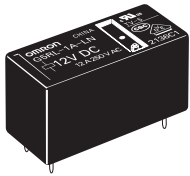

PCB Mounting Holes
(BOTTOM VIEW)

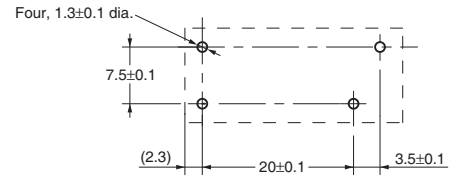

Terminal Arrangement/
Internal Connections
(BOTTOM VIEW)

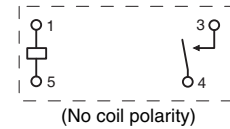

G5RL-1A-E-LN
G5RL-1A-E-HR
G5RL-1A-E-TV8

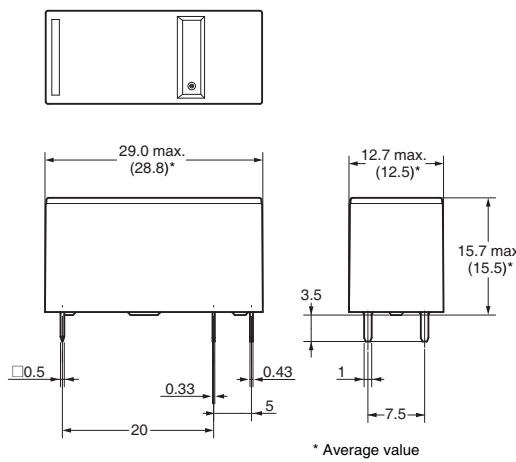
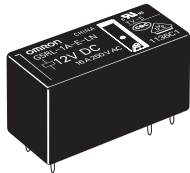

PCB Mounting Holes
(BOTTOM VIEW)

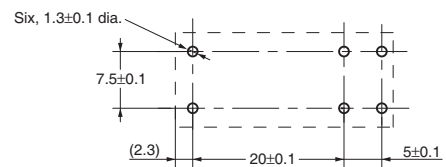

Terminal Arrangement/
Internal Connections
(BOTTOM VIEW)

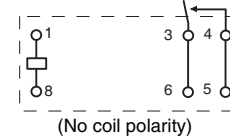

G5RL-1-E
G5RL-1-E-HR

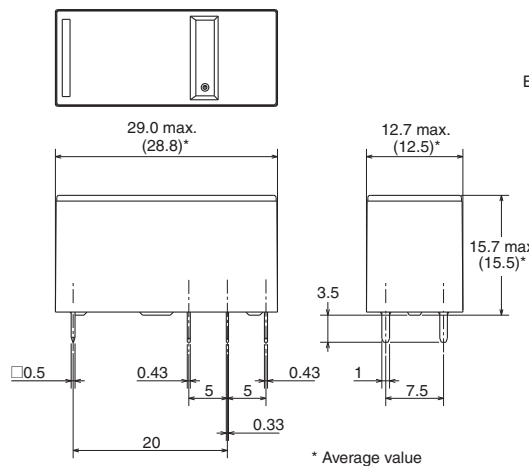
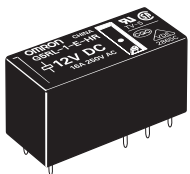

PCB Mounting Holes
(BOTTOM VIEW)

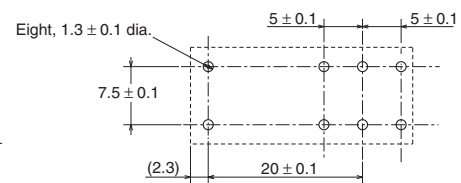

Terminal Arrangement/
Internal Connections
(BOTTOM VIEW)

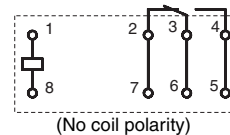

Approved Standards

UL/C-UL Recognized (File No.E41643)

Model	Contact form	Coil ratings	Contact ratings	Number of test operations
G5RL-1A-LN	SPST-NO (1a)	5 to 24 VDC	12 A, 250 VAC Resistive, 40°C	100,000
			12 A, 24 VDC Resistive, 40°C	
			TV-5, 120 VAC, 40°C	25,000
G5RL-1A-E-LN	SPST-NO (1a)	5 to 24 VDC	16 A, 250 VAC Resistive, 40°C	50,000
			16 A, 24 VDC Resistive, 40°C	
			TV-5, 120 VAC, 40°C	25,000

Note. CSA standards: Certified by C-UL.

UL Recognized (File No.E41643) and CSA Certified (File No. LR31928)

Model	Contact form	Coil ratings	Contact ratings	Number of test operations
G5RL-1A-TV8	SPST-NO(1a)	5 to 48 VDC	12 A, 277 VAC General, 40°C	80,000
			TV-8, 120 VAC, 40°C	25,000
			A300 Pilot Duty, 720 VA, 240 VAC, 40°C	30,000
			1/2 Hp, 120 VAC, 40°C	6,000
			60 LRA/10 FLA, 250 VAC, 40°C	6,000
G5RL-1A-E-TV8	SPST-NO(1a)	5 to 48 VDC	16 A, 277 VAC General, 40°C	50,000
			TV-8, 120 VAC, 40°C	25,000
			A300 Pilot Duty, 720 VA, 240 VAC, 40°C	30,000
			1/2 Hp, 120 VAC, 40°C	6,000
			60 LRA/10 FLA, 250 VAC, 40°C	6,000
G5RL-1(A)-E-HR	SPST-NO (1a)	5 to 48 VDC	16 A, 277 VAC General, 40°C	50,000
			TV-5, 120 VAC, 40°C	25,000
G5RL-1-E	SPDT-NO (1a)	24 to 240 VAC (G5RL-1-E)	A300 Pilot Duty, 720 VA, 240 VAC, 40°C	30,000
			1/2 Hp, 120 VAC, 40°C	6,000
	SPDT-NC (1b)	5 to 48 VDC 24 to 240 VAC (G5RL-1-E)	5 A, 250 VAC General, 40°C	50,000
			5 A, 24 VDC Resistive, 40°C	50,000

VDE Certified (EN61810-1) (License No. 40007172)

Model	Contact form	Coil ratings	Contact ratings	Number of test operations
G5RL-1A-LN	SPST-NO (1a)	5, 12, 24VDC	12 A, 250 VAC $\cos\phi=1$, 85°C	60,000
G5RL-1A-E-LN	SPST-NO (1a)	5, 12, 24VDC	16 A, 250 VAC $\cos\phi=1$, 85°C	30,000
G5RL-1A-TV8	SPST-NO (1a)	5, 12, 24, 48 VDC	12 A, 250 VAC $\cos\phi=1$, 85°C	40,000
			230 VAC 70 A (0-P) Steady 1 A (rms), 85°C	20,000
G5RL-1A-E-TV8	SPST-NO (1a)	5, 12, 24, 48 VDC	16 A, 250 VAC $\cos\phi=1$, 85°C	15,000
			240 VAC 100 A (0-P) Steady 10 A (rms), 85°C	50,000
			240 VAC 50 A (0-P) Steady 5 A (rms), 85°C	100,000
G5RL-1(A)-E-HR	SPST-NO (1a)	5, 12, 24, 48 VDC	16 A, 250 VAC $\cos\phi=1$, 85°C	15,000
			240 VAC 100 A (0-P) Steady 10 A (rms), 85°C	50,000
G5RL-1-E	SPDT-NO (1a)	24, 100, 115/120, 200, 230/240 VAC (50 Hz)	240 VAC 50 A (0-P) Steady 5 A (rms), 85°C	100,000
			16 A, 250 VAC $\cos\phi=1$, 70°C	15,000

Creepage distance		8 mm min.
Clearance distance		8 mm min.
Insulation material group		IIIa
Type of insulation	coil-contact circuit	Reinforced
	open contact circuit	Micro disconnection
Rated Insulation voltage		250 V
Pollution degree		3 (Flux protection)
Rated voltage system		250 V
Over voltage category		III
Category of protection according to IEC 61810-1		RT II (Flux protection)
Tracking Index of relay base		PTI 250 V min. (housing parts)

■Precautions

●Please refer to “PCB Relays Common Precautions” for correct use.

Correct Use

●Mounting

- When mounting a G5RL-LN Relay (Silent Relay) on a PCB, use a diode for surge absorption for the coil.

●Wiring of High-capacity Models (-E)

- High-capacity models (-E) have a structure that connects two terminals from one contact. When designing the circuit, use both terminals. If you use only one terminal, the Relay may be unable to satisfy specified performance.

●Others

- Do not decrease coil voltage after operation and do not use a pulse wave drive.

●Precautions for Correct Use

- This product is not suitable for vehicles such as automobiles (including two-wheeled vehicles).

- If the product is used in the following applications, consult your OMRON sales representative to check the necessary items according to the specification sheets. Also make sure the product is used within the specified ratings and performance ranges with an ample margin and implement safety measures, such as designing a safety circuit, to minimize danger should the product fail.

- Outdoor use, uses involving potential chemical contamination or electrical interference.
- Nuclear energy control systems, combustion systems, railroad systems, aviation systems, medical equipment, safety equipment, and equipment that could present a risk to human life or body.
- Equipment requiring a high level of reliability, such as gas, water, or electrical supply systems.

▪ Application examples provided in this document are for reference only. In actual applications, confirm equipment functions and safety before using the product.
 ▪ Consult your OMRON representative before using the product under conditions which are not described in the manual or applying the product to nuclear control systems, railroad systems, aviation systems, vehicles, combustion systems, medical equipment, amusement machines, safety equipment, and other systems or equipment that may have a serious influence on lives and property if used improperly. Make sure that the ratings and performance characteristics of the product provide a margin of safety for the system or equipment, and be sure to provide the system or equipment with double safety mechanisms.

Note: Do not use this document to operate the Unit.

X-ON Electronics

Largest Supplier of Electrical and Electronic Components

Click to view similar products for [General Purpose Relays](#) category:

Click to view products by [Omron](#) manufacturer:

Other Similar products are found below :

[PCN-105D3MH,000](#) [59641F200](#) [LY1SAC110120](#) [5X827E](#) [5X837F](#) [5X840F](#) [5X842F](#) [5X848E](#) [LY2N-AC120](#) [LY2S-AC220/240](#) [LY2-US-AC120](#) [LY3-US-AC120](#) [LY4F-UA-DC12](#) [LY4F-UA-DC24](#) [LY4F-US-AC120](#) [LY4F-US-AC240](#) [LY4F-US-DC24](#) [LY4F-VD-AC110](#) [LYQ20DC12](#) [M115C60](#) [M115N010](#) [M115N0150](#) [6031007G](#) [603-12D](#) [61211T0B4](#) [61212T400](#) [61222Q400](#) [61243B600](#) [61243C500](#) [61243Q400](#) [61311BOA2](#) [61311BOA6](#) [61311BOA8](#) [61311C0A2](#) [61311COA1](#) [61311COA6](#) [61311F0A2](#) [61311QOA1](#) [61311QOA4](#) [61311T0D6](#) [61311TOA6](#) [61311TOA7](#) [61311TOB3](#) [61311TOB4](#) [61311U0A6](#) [61312Q600](#) [61312T400](#) [61312T600](#) [61313U200](#) [61313U400](#)