

Low Signal Relay G6A

Fully Sealed Relay with High Impulse Withstand

- High sensitivity — can be driven by digital circuits.
- Low-profile design allows use in 12.70 mm PC board rack.
- Surge withstand voltage meets FCC Part 68 regulation.
- Units can be mounted side by side due to low magnetic leakage.
- Special models available for low thermoelectromotive force.
- Unique moving loop (permanent magnet) armature reduces relay size, magnetic interference, and contact bounce time.
- Single or dual coil winding types available.
- RoHS Compliant

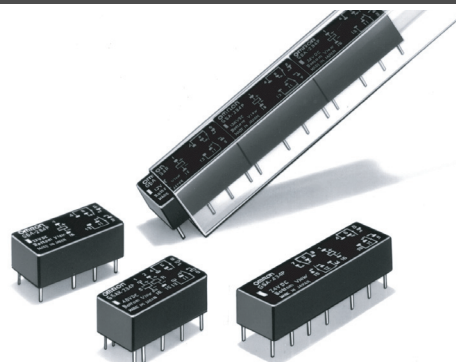

Ordering Information

To Order: Select the part number and add the desired coil voltage rating, (e.g., G6A-274P-ST-US-DC12).

■ Non-latching

Type	Contact form	Model
		Ag (Au clad)
Standard	DPDT	G6A-274P-ST-US
Low-sensitivity	DPDT	G6A-274P-ST40-US

■ Latching

Single Coil

Type	Contact form	Model
		Ag (Au clad)
Standard	DPDT	G6AU-274P-ST-US

Dual Coil

Type	Contact form	Model
		Ag (Au clad)
Standard	DPDT	G6AK-274P-ST-US
Low-sensitivity	DPDT	G6AK-274P-ST40-US

Specifications

■ Contact Data

Type	G6A-274P-ST(40)-US G6AK-274P-ST(40)-US G6AU-274P-ST-US	
Load	Resistive load (p.f. = 1)	Inductive load (p.f. = 0.4) (L/R = 7 ms)
Rated load	0.50 A at 125 VAC, 2 A at 30 VDC	0.3 A* at 125 VAC, 1 A at 30 VDC
Contact material	Ag (Au clad)	
Carry current	3 A	
Max. operating voltage	250 VAC, 220 VDC	
Max. operating current	2 A	1 A
Max. switching capacity	125 VA, 60 W	62.50 VA, 30 W
Min. permissible load (See note)	10 μA, 10 mVDC	

* 0.25A at 125VAC for latching models

Note: P level: $\lambda_{60} = 0.1 \times 10^{-6}/\text{operation}$

This value was measured at a switching frequency of 60 operations/min and the criterion of contact resistance is 50 Ω. This value may vary depending on the switching frequency and operating environment. Always double-check relay suitability under actual operating conditions.

■ Coil Data

Standard Non-latching DPDT (G6A-274P-ST-US)

Rated voltage (VDC)	Rated current (mA)	Coil resistance (Ω)	Coil inductance (ref. value) (H)		Pick-up voltage	Dropout voltage	Maximum voltage	Power consumption (mW)
			Armature OFF	Armature ON				
3	66.70	45	0.07	0.065	70% max.	10% min.	200% at 23°C	Approx. 200
4.5	44.6	101	0.16	0.14				
5	40	125	0.20	0.18				
6	33.30	180	0.29	0.26				
9	22.20	405	0.63	0.57				
12	16.70	720	1.10	1.06				
24	8.30	2,880	4.50	4.10				
48	4.90	9,750	13.70	12.50				
								Approx. 235

Low-sensitivity Non-latching DPDT (G6A-274P-ST40-US)

Rated voltage (VDC)	Rated current (mA)	Coil resistance (Ω)	Coil inductance (ref. value) (H)		Pick-up voltage	Dropout voltage	Maximum voltage	Power consumption (mW)
			Armature OFF	Armature ON				
3	133.30	22.50	0.03	0.02	70% max.	10% min.	150% at 23°C	Approx. 400
4.5	88.9	50.6	0.065	0.06				
5	80	62.50	0.08	0.07				
6	66.70	90	0.11	0.10				
9	44.30	203	0.27	0.23				
12	33.30	360	0.52	0.43				
24	16.70	1,440	2.10	1.80				
48	8.30	5,760	7.50	6.40				

Note: 1. The rated current and coil resistance are measured at a coil temperature of 23°C with a tolerance of ±10%.

2. Operating characteristics are measured at a coil temperature of 23°C.

3. The maximum voltage is the highest voltage that can be imposed on the relay coil.

Standard Single Coil Latching DPDT (G6AU-274P-ST-US)

Rated voltage (VDC)	Rated current (mA)	Coil resistance (Ω)	Coil inductance (ref. value) (H)		Set pick-up voltage	Reset pick-up voltage	Maximum voltage	Power consumption (mW)
			Armature OFF	Armature ON				
3	33.70	89	0.15	0.11	70% max.	70% min.	200% at 23°C	Approx. 100
4.5	22.2	202	0.34	0.25				
5	20	250	0.44	0.35				
6	16.70	360	0.64	0.48				
9	11.10	810	1.38	1.07				
12	8.30	1,440	2.50	2				
24	4.20	5,760	9.20	7.20				
48	2.50	19,000	28.50	22				

Standard Dual Coil Latching DPDT (G6AK-274P-ST-US)

Rated voltage (VDC)	Rated current (mA)	Coil resistance (Ω)	Coil inductance (ref. value) (H)				Set pick-up voltage	Reset pick-up voltage	Maximum voltage	Power consumption (mW)
			Set coil		Reset coil					
			Armature OFF	Armature ON	Armature OFF	Armature ON				
3	66.70	45	0.037	0.027	0.027	0.037	70% max.	70% min.	200% at 23°C	Approx. 200
4.5	40.2	112	0.09	0.065	0.065	0.09				
5	36	139	0.11	0.08	0.08	0.11				
6	30	200	0.16	0.12	0.12	0.16				
9	20	450	0.38	0.28	0.28	0.38				
12	15	800	0.60	0.45	0.45	0.60				
24	7.50	3,200	2.10	1.50	1.50	2.10				
48	4.20	11,520	8.50	6.30	6.30	8.50				

Low-sensitivity Dual Coil Latching DPDT (G6AK-274P-ST40-US)

Rated voltage (VDC)	Rated current (mA)	Coil resistance (Ω)	Coil inductance (ref. value) (H)				Set pick-up voltage	Reset pick-up voltage	Maximum voltage	Power consumption (mW)
			Set coil		Reset coil					
			Armature OFF	Armature ON	Armature OFF	Armature ON				
3	120	25	0.015	0.01	0.01	0.015	70% max.	70% min.	150% at 23°C	Approx. 360
4.5	79.9	56.3	0.04	0.025	0.025	0.04				
5	72.50	69	0.05	0.035	0.035	0.05				
6	60	100	0.07	0.05	0.05	0.07				
9	40	225	0.16	0.12	0.12	0.16				
12	30	400	0.28	0.20	0.20	0.28				
24	15	1,600	1.10	0.75	0.75	1.10				
48	7.50	6,400	4	2.90	2.9	4				

- Note:**
1. The rated current and coil resistance are measured at a coil temperature of 23°C with a tolerance of ±10%.
 2. Operating characteristics are measured at a coil temperature of 23°C.
 3. The maximum voltage is the highest voltage that can be imposed on the relay coil.

■ Characteristics

Type		Non-latching	Latching
Contact resistance (See note 1)		50 mΩ max.	
Operate (set) time (See note 2)	DPDT	5 ms max. (mean value approx. 3 ms)	5 ms max. (mean value approx. 2.50 ms)
Release (reset) time (See note 2)	DPDT	3 ms max. (mean value approx. 1.20 ms)	5 ms max. (mean value approx. 2.50 ms)
Min. set/reset signal width	DPDT	7 ms min.	
Operating frequency	Mechanical	36,000 operations/hour	
	Electrical	1,800 operations/hour (under rated load)	
Insulation resistance (See note 3)		1,000 MΩ min. (at 500 VDC); except for set-reset	
Dielectric strength		1,000 VAC, 50/60 Hz for 1 minute between coil and contacts 1,000 VAC, 50/60 Hz for 1 minute between contacts of different poles 1,000 VAC, 50/60 Hz for 1 minute between contacts of same pole 250 VAC, 50/60 Hz for 1 minute between set and reset coils	
Surge withstand voltage		1,500 V (10 x 160 μs) (conforms to FCC Part 68)	
Vibration	Mechanical durability	10 to 55 Hz; 5 mm double amplitude	
	Malfunction durability	10 to 55 Hz; 3.3 mm double amplitude	
Shock	Mechanical durability	1,000 m/s ² (Approx. 100G)	
	Malfunction durability	DPDT: 500 m/s ² (Approx. 50 G)	
Ambient temperature		-40° to 70°C with no icing	
Humidity		5% to 85% RH	
Service life	Mechanical	100 million operations min. (at 36,000 operations/hour)	
	Electrical	500,000 operations min. (at 1,800 operations/hr) See "Characteristic Data"	
Weight	DPDT	Approx. 3.5 g	
	4PDT	Approx. 6.0 g	

- Note:**
- The contact resistance was measured with 10 mA at 1 VDC with a fall-of-potential method.
 - Values in parentheses are typical values unless otherwise stated.
 - The insulation resistance was measured with a 500-VDC megohmmeter applied to the same parts as those for checking the dielectric strength (except between the set and reset coil).
 - The above values are initial values.

■ Approvals

UL Recognized (File No. E41515) / CSA Certified (File No. LR31928) - - Ambient Temp. = 40°C

Type	Contact form	Coil rating	Contact ratings	Number of test operations
G6A()-274P-ST()-US	DPDT	1.5 to 48 VDC	1 A at 125 VAC (General Purpose) 2 A at 30 VDC (General Purpose) 0.6 A at 110 VDC (General Purpose)	6,000

- Note:**
- The rated values approved by each of the safety standards (e.g., UL and CSA) may be different from the performance characteristics individually defined in this catalog.
 - In the general interest of product improvement, specifications are subject to change.

■ Characteristic Data

Maximum Switching Capacity DPDT

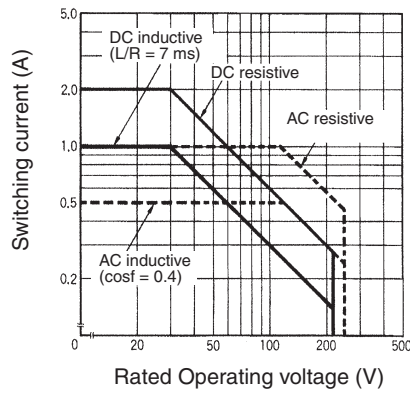

Ambient Temperature vs. Maximum Coil Voltage

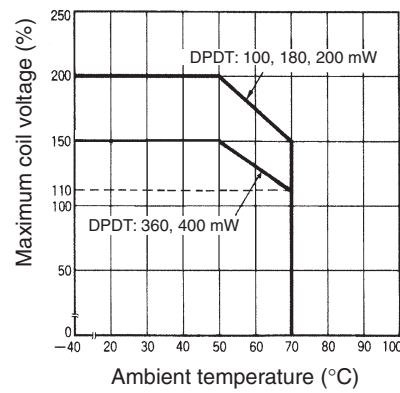

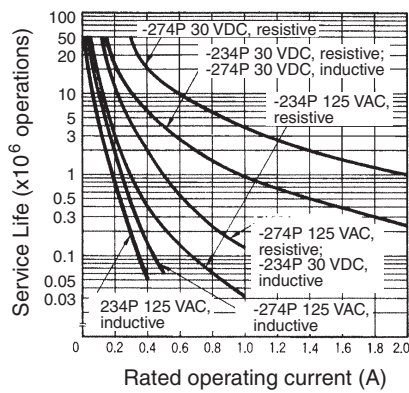

Note: The maximum coil voltage refers to the maximum value in a varying range of operating power voltage, not a continuous voltage.

Electrical Service Life DPDT



Dimensions

Note: 1. All units are in millimeters unless otherwise indicated.
 2. Orientation marks are indicated as follows:  

■ Non-latching

G6A-274P-ST(40)-US

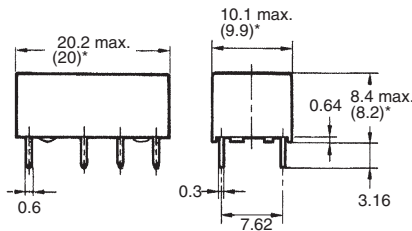
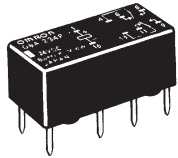

*Average value

Terminal Arrangement/
Internal Connections
(Bottom View)

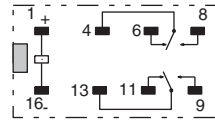

Mounting Holes
(Bottom View)

Tolerance: ± 0.1

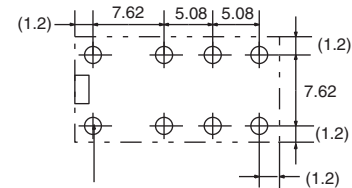

Eight, 1.0-dia. holes

■ Latching

G6AU-274P-ST-US

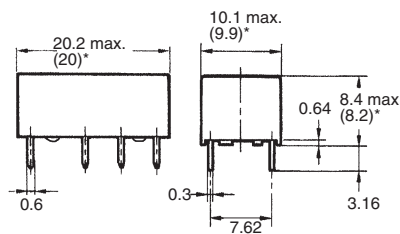
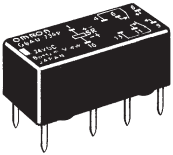

*Average value

Terminal Arrangement/
Internal Connections
(Bottom View)

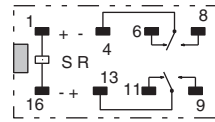

Mounting Holes
(Bottom View)

Tolerance: ± 0.1

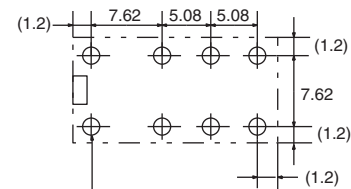

Eight, 1.0-dia. holes

G6AK-274P-ST(40)-US

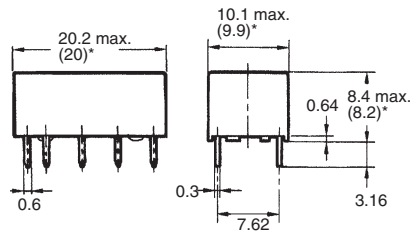
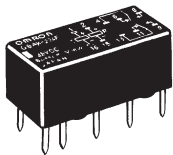

*Average value

Terminal Arrangement/
Internal Connections
(Bottom View)

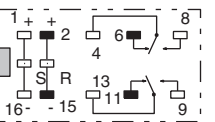

Mounting Holes
(Bottom View)

Tolerance: ± 0.1

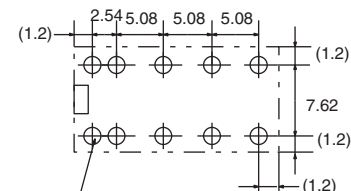

Ten, 1-dia. holes

Precautions

Long-term Continuously ON Contacts

Using the Relay in a circuit where the Relay will be ON continuously for long periods (without switching) can lead to unstable contacts because the heat generated by the coil itself will affect the insulation, causing a film to develop on the contact surfaces. Be sure to use a fail-safe circuit design that provides protection against contact failure or coil burnout. Otherwise, use a latching relay.

Relay Handling

When washing the product after soldering the Relay to a PCB, use a water-based solvent or alcohol-based solvent, and keep the solvent temperature to less than 40°C. Do not put the Relay in a cold cleaning bath immediately after soldering.



All sales are subject to Omron Electronic Components LLC standard terms and conditions of sale, which can be found at http://www.components.omron.com/components/web/webfiles.nsf/sales_terms.html

ALL DIMENSIONS SHOWN ARE IN MILLIMETERS.

To convert millimeters into inches, multiply by 0.03937. To convert grams into ounces, multiply by 0.03527.

OMRON[®]

**OMRON ELECTRONIC
COMPONENTS LLC**

55 E. Commerce Drive, Suite B
Schaumburg, IL 60173

847-882-2288

OMRON ON-LINE

Global - <http://www.omron.com>

USA - <http://www.components.omron.com>

Cat. No. X301-E-1b

09/11

Specifications subject to change without notice

Printed in USA

X-ON Electronics

Largest Supplier of Electrical and Electronic Components

Click to view similar products for [Low Signal Relays - PCB category](#):

Click to view products by [Omron manufacturer](#):

Other Similar products are found below :

[LZN4-US-DC12](#) [LZNQ4-US-DC24](#) [LZNQ4-US-DC48](#) [6-1393813-4](#) [6-1462039-0](#) [6-1617347-5](#) [6-1617353-3](#) [6-1617529-6](#) [M39016/20-054M](#) [M39016/27-030M](#) [67RPCX-3](#) [MAHC-5494](#) [D3493L](#) [7-1393809-0](#) [7-1393813-3](#) [741B8](#) [7556072001](#) [MF-11AM-24](#) [MF1201N12](#) [MF-17A-24](#) [FBR244D012/02CP](#) [FBR244D024/02CS](#) [80.010.4522.1](#) [FL-4036](#) [FLH-11D-6](#) [831A7](#) [MMS124](#) [FTR-B4GA006Z](#) [FW1102S06](#) [FW1201S39](#) [FW1210S02](#) [FW1521S01](#) [FW5A1201S14](#) [9-1393813-6](#) [9-1617582-5](#) [G6AK-2-H-DC5](#) [G6E-184P-ST-US-DC48](#) [G6G234CDC24](#) [A07A939BZ1-0388](#) [A150-0005](#) [PZ-2A2420](#) [HB1-DC6V](#) [HB1-DC9V](#) [R10-14A10-240](#) [R10-14D10-12](#) [R10-5A10-120F](#) [R10-E1L8-S200](#) [R10-E2468-1](#) [R10-E4Z2-V700](#) [R10-T1L2N-115V](#)