

# High-frequency Relay G6W

## Surface-mountable 5 GHz Band Miniature SPDT High-frequency Relay

- Superior high-frequency characteristics, such as an isolation of 35 dB min., insertion loss of 0.5 dB max., and V.S.W.R. of 1.7 max. at 5 GHz (50 Ω).
- High-frequency characteristics obtained by adopting tri-plate micro strip line design.
- Small size at 20 x 9.4 x 8.9 mm (L x W x H).
- Y-shape terminal structure and reverse contact option simplifies wiring to PCBs.
- RoHS Compliant.

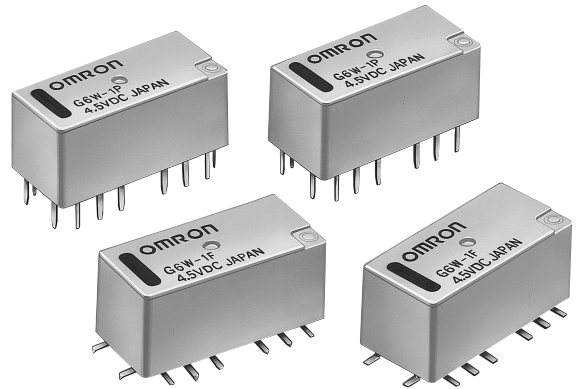

## Ordering Information

Classification				Non latching	Single-coil latching	Dual-coil latching
SPDT	Fully sealed	Through-hole terminal	Y-shape terminal	G6W-1P	G6WU-1P	G6WK-1P
		Surface-mount terminal	Y-shape terminal	G6W-1F	G6WU-1F	G6WK-1F

**Note:** When ordering, add the rated coil voltage to the model number.

Example: G6W-1P DC12

└── Rated coil voltage

### Model Number Legend:

G6W   -       -  

1    2   3   4   5

#### 1. Relay function

- None: Non-latching
- U: Single-coil latching
- K: Dual-coil latching

#### 2. Contact form

- 1: SPDT

#### 3. Terminal shape

- F: Surface-mount terminals
- P: PCB through-hole terminals

#### 4. Terminal Structure

- None: Y-shape terminal (standard)

#### 5. Contact Arrangement

- None: Standard contact arrangement
- R: Reverse contact arrangement (Available only for Non-Latching versions)

## Typical Applications

- Mobile phone base station (W-CDMA, UMTS, CDMA-2000, PCS)
- Wireless LAN and TV transmitters
- Test and Measurement devices
- Signal Generators

# Specifications

## ■ Contact Ratings

Load type	Resistive load
Contact material	Au clad Cu alloy
Rated load	10 mA at 30 VAC; 10 mA at 30 VDC 2.5 GHz, 50 Ω, 10 W (See note 2)
Rated carry current	0.5 A
Max. switching voltage	30 VDC, 30 VAC
Max. switching current	0.5 A

## ■ High-frequency Characteristics

Frequency	2.0 GHz	2.5 GHz	5.0 GHz
Isolation	65 dB min.	60 dB min.	35 dB min.
Insertion loss	0.2 dB max.		0.5 dB max.
V.S.W.R.	1.2 max.		1.7 max.
Max. carry power	20 W (See note 2)		
Max. switching power	10 W (See note 2)		

- Note: 1. The above values are initial values.  
2. These values are for a load with V.S.W.R.  $\leq 1.2$  at an impedance of 50 Ω.

## ■ Coil Ratings

### Non-latching Relays (G6W-1F, G6W-1P)

Rated voltage	3 VDC	4.5 VDC	9 VDC	12 VDC	24 VDC
Rated current	66.7 mA	44.4 mA	22.2 mA	16.7 mA	8.3 mA
Coil resistance	45 Ω	101 Ω	405 Ω	720 Ω	2,880 Ω
Must operate voltage	80% of max. of rated voltage				
Must release voltage	10% min. of rated voltage				
Maximum voltage	150% of rated voltage				
Power consumption	Approx. 200 mW				

### Single-coil Latching Relays (G6WU-1F, G6WU-1P)

Rated voltage	9 VDC	12 VDC
Rated current	22.2 mA	16.7 mA
Coil resistance	405 Ω	720 Ω
Must set voltage	80% max. of rated voltage	
Must reset voltage	80% max. of rated voltage	
Maximum voltage	150% of rated voltage	
Power consumption	Approx. 200 mW	

### Dual-coil Latching Relays (G6WK-1F, G6WK-1P)

Rated voltage	3 VDC	4.5 VDC	9 VDC	12 VDC	24 VDC
Rated current	120 mA	80 mA	40 mA	30 mA	15 mA
Coil resistance	25 Ω	56 Ω	225 Ω	400 Ω	1,600 Ω
Must set voltage	80% max. of rated voltage				
Must reset voltage	80% max. of rated voltage				
Maximum voltage	150% of rated voltage				
Power consumption	Approx. 360 mW				

- Note: 1. The rated current and coil resistance are measured at a coil temperature of 23°C with a tolerance of  $\pm 10\%$ .  
2. The operating characteristics are measured at a coil temperature of 23°C.  
3. The maximum voltage is the highest voltage that can be imposed on the relay coil.  
4. The voltage measurements for operate/release and set/reset are the values obtained for instantaneous changes in the voltage. (Rectangular wave).

## Characteristics

Item	Non-latching	Single-coil latching	Dual-coil latching
	G6W-1F, G6W-1P	G6WU-1F, G6WU-1P	G6WK-1F, G6WK-1P
Contact resistance (See note 2)	100 mΩ max.		
Operate (set) time (See note 3)	10 ms max. (Approx. 3.5 ms)	10 ms max. (Approx. 2.5 ms)	
Release (reset) time (See note 3)	10 ms max. (Approx. 2.5 ms)		
Minimum set/reset signal width	-----	12 ms	
Insulation resistance (See note 4)	1,000 MΩ min. (at 500 VDC)		
Dielectric strength	Coil and contacts	1,000 VAC, 50/60 Hz for 1 min	
	Coil and ground, contacts and ground	500 VAC, 50/60 Hz for 1 min	
	Contact of same polarity	500 VAC, 50/60 Hz for 1 min	
Vibration resistance	Destruction	10 to 55 Hz, 1.5-mm double amplitude	
	Malfunction	10 to 55 Hz, 2-mm double amplitude	
Shock resistance	Destruction	1,000 m/s <sup>2</sup>	
	Malfunction	500 m/s <sup>2</sup>	
Endurance	Mechanical	1,000,000 operations min. (at 36,000 operations/hour)	
	Electrical	300,000 operations min. (with a rated load at 1,800 operations/hour) 100,000 operations min. (2.5GHz, 50 Ω, 10 W)	
Ambient temperature	Operating: -40°C to 70°C (with no icing or condensation)		
Ambient humidity	Operating: 5% to 85%		
Weight	Approx. 3 g		

- Note:**
- The above values are initial values.
  - The contact resistance was measured with 10 mA at 1 VDC with a fall-of-potential method.
  - Values in parentheses are typical values.
  - The insulation resistance was measured with a 500-VDC Megger Tester applied to the same parts as those used for checking the dielectric strength.

## Engineering Data

**Ambient Temperature vs. Maximum Voltage**

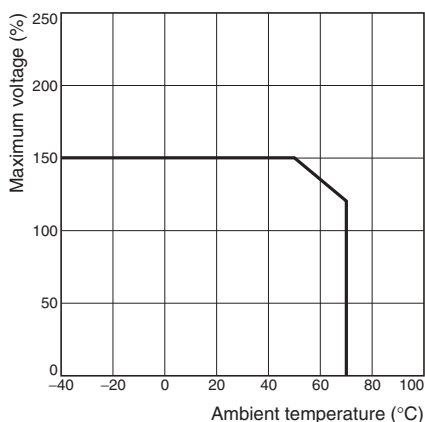

**Note:** "Maximum voltage" is the maximum voltage that can be applied to the relay coil.

**Ambient Temperature vs. Must Set or Must Reset Voltage**

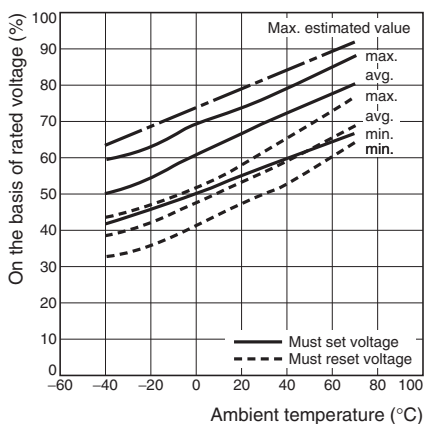

**Shock Malfunction**

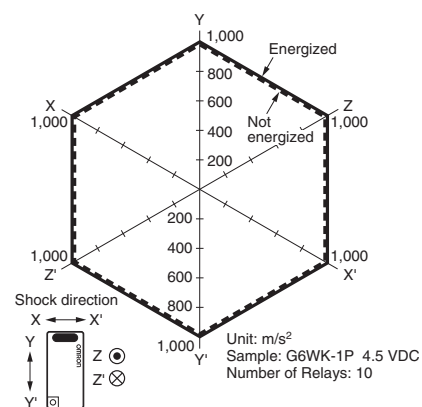

Conditions: Shock is applied in ±X, ±Y, and ±Z directions three times each with and without energizing the relays to check the number of contact malfunctions.

**Electrical Endurance, DC Load:  
Must Set and Must Reset Voltage  
(See notes 1 and 2)**

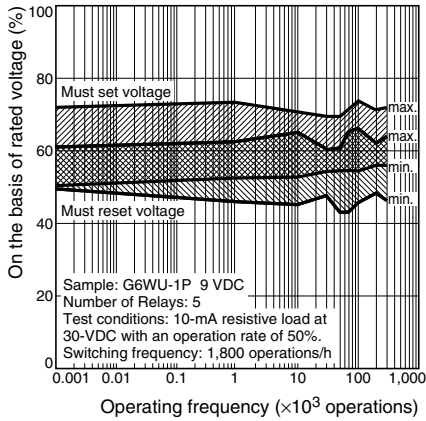

**Electrical Endurance, AC Load:  
Must Set and Must Reset Voltage  
(See notes 1 and 2)**

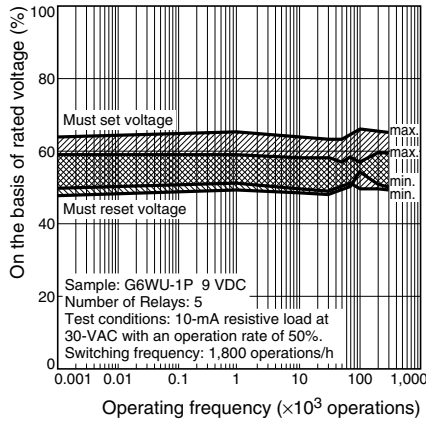

**Electrical Endurance, DC Load:  
Contact Resistance  
(See notes 1 and 2)**

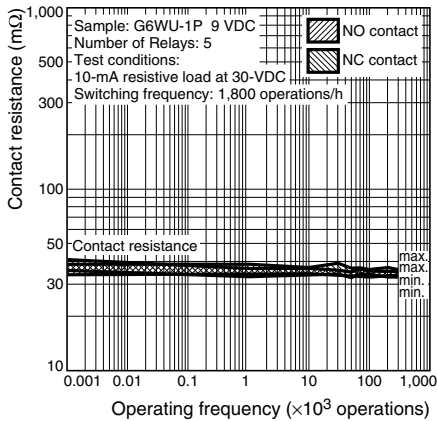

**Electrical Endurance, AC Load:  
Contact Resistance  
(See notes 1 and 2)**

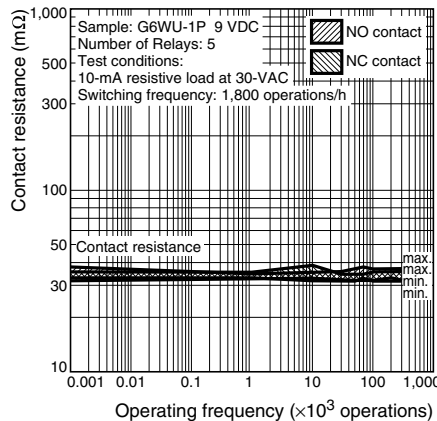

**External Magnetic Interference**

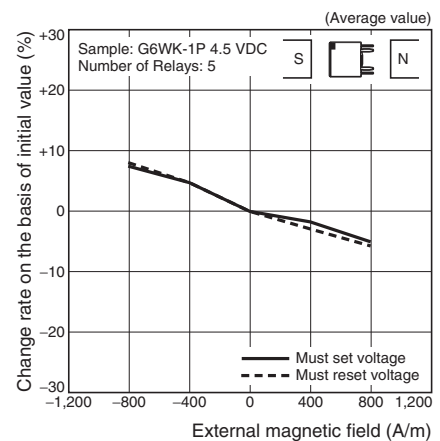
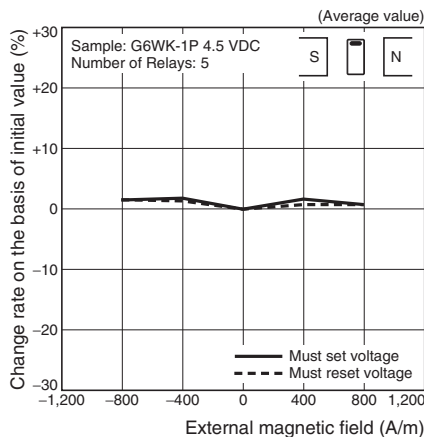
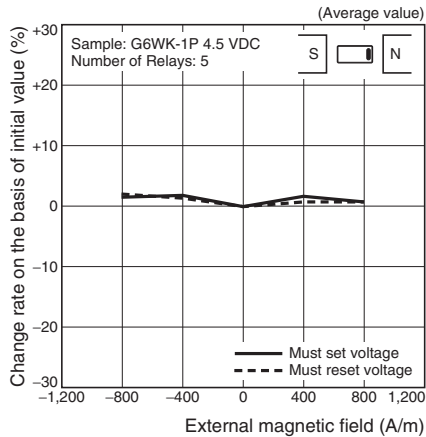

- Note: 1.** The tests were conducted at an ambient temperature of 23°C
- 2.** The contact resistance data are periodically measured reference values and are not values from monitoring each operation. Contact resistance values will vary according to the switching frequency and operating environment. Therefore, be sure to check the operation under the actual operating conditions before use.

**Isolation**  
(See notes 1 and 2)

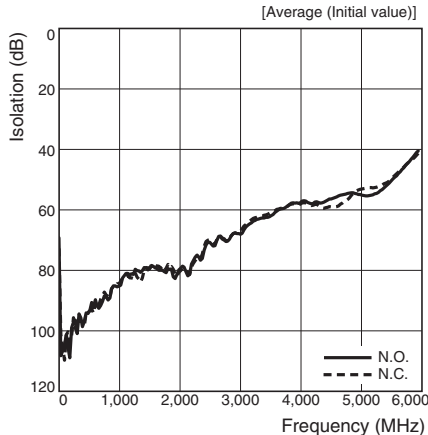

**Insertion Loss**  
(See notes 1 and 2)

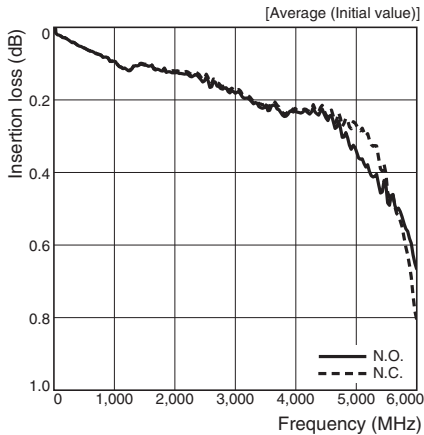

**V.S.W.R. / Return Loss**  
(See notes 1 and 2)

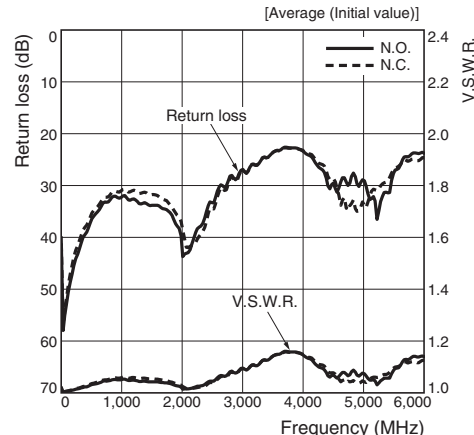

**Must Set and Must Reset**  
**Time Distribution (see note 1).**

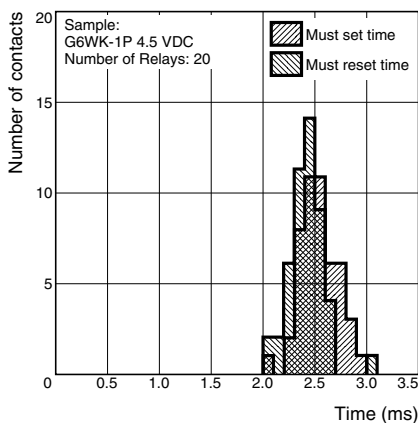

**Must Set and Must Reset**  
**Bounce Time Distribution (see note 1).**

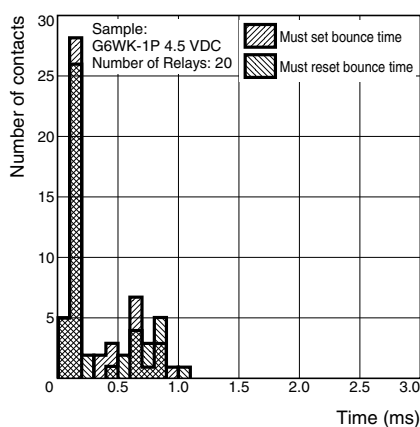

Note: 1. The tests were conducted at an ambient temperature of 23°C.

2. High-frequency characteristics depend upon the PCB to which the relay is mounted. Always check these characteristics, including endurance (life expectancy) in the actual application before use.

**Dimensions**

Note: All units are in millimeters unless otherwise indicated.

**G6W-1F**  
**G6WU-1F**

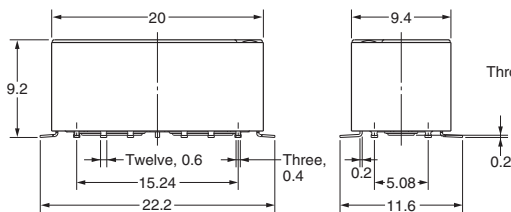
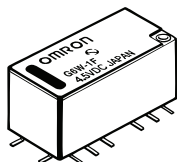

**Mounting Pads**  
**(Top View)**

Tolerance: ±0.1 mm

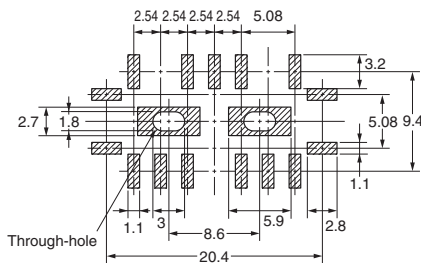

**Terminal Arrangement/**  
**Internal Connections**  
**(Top View)**

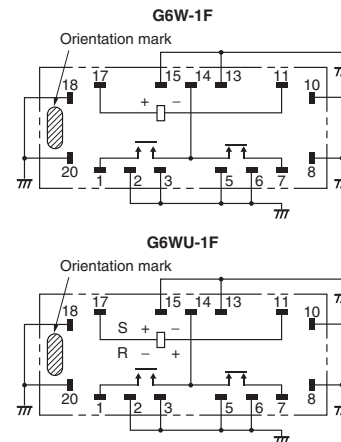

Note: 1. Tolerance: ±0.3 mm unless specified.  
2. The coplanarity of the terminals is 0.1 mm max.

**G6W-1P  
G6WU-1P**

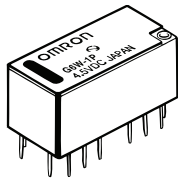

**Mounting Holes  
(Bottom View)**

Tolerance:  $\pm 0.1$  mm

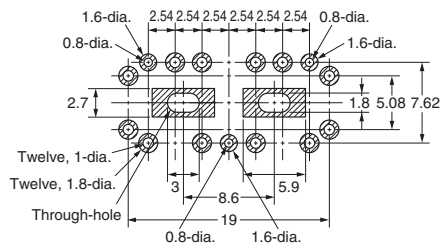

**Terminal Arrangement/  
Internal Connections  
(Bottom View)**

**G6W-1P**

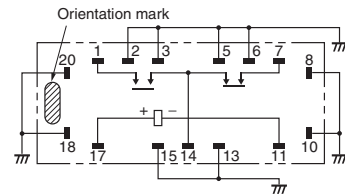

**G6WU-1P**

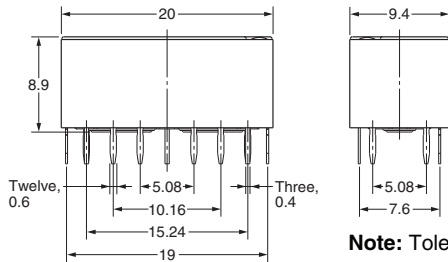
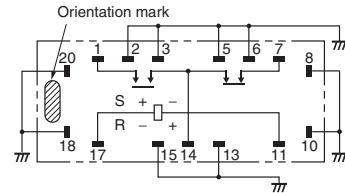

**Note:** Tolerance:  $\pm 0.3$  mm unless specified.

**G6WK-1F**

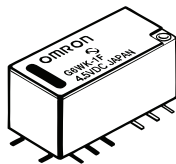

**Mounting Pads  
(Top View)**

Tolerance:  $\pm 0.1$  mm

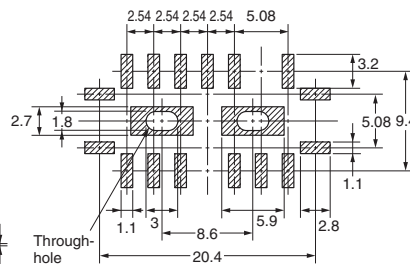

**Terminal Arrangement/  
Internal Connections  
(Top View)**

**G6WK-1F**

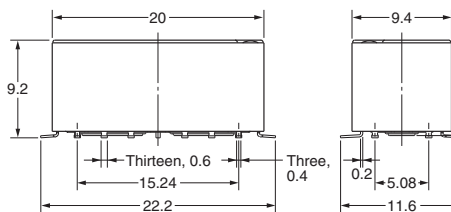
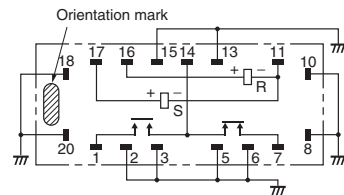

**Note:** 1. Tolerance:  $\pm 0.3$  mm unless specified.  
2. The coplanarity of the terminals is 0.1 mm max.

**G6WK-1P**

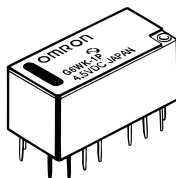

**Mounting Holes  
(Bottom View)**

Tolerance:  $\pm 0.1$  mm

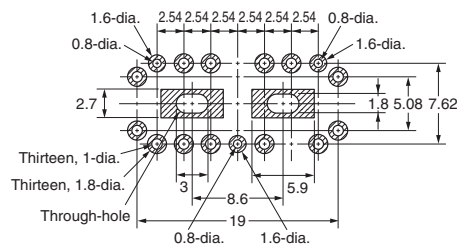

**Terminal Arrangement/  
Internal Connections  
(Bottom View)**

**G6WK-1P**

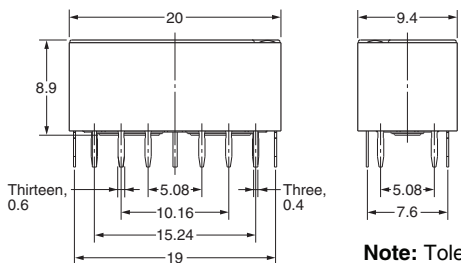
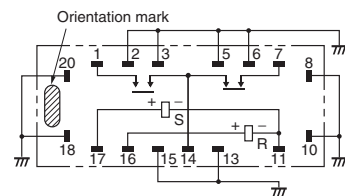

**Note:** Tolerance:  $\pm 0.3$  mm unless specified.

# Recommended Soldering Method

## Temperature Profile According to IRS Method

When performing reflow-soldering, check the profile on an actual device after setting the temperature condition so that the temperatures at the relay terminals and the upper surface of the case do not exceed the limits specified in the following table.

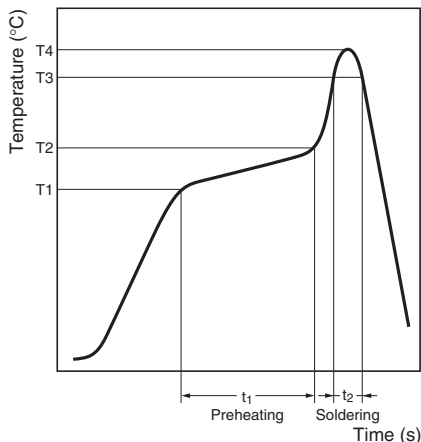

Item	Preheating (T1 to T2, t <sub>1</sub> )	Soldering (T3, t <sub>2</sub> )	Peak value (T4)
Measuring position			
Terminal	150°C to 180°C, 120 s max.	230°C min., 30 s max.	250°C max.
Upper surface of case	---	---	255°C max.

The thickness of cream solder to be applied should be within a range between 150 and 200 μm on OMRON's recommended PCB pattern.

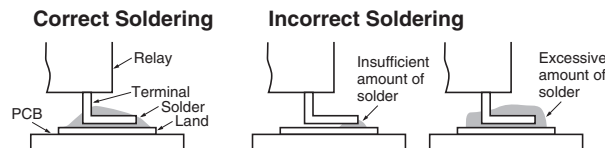

Visually check that the Relay is properly soldered.

## Bottom Ground Soldering Conditions

To solder the bottom ground, manually solder separately from the terminals according to the following conditions.

- Soldering iron: 50 W
- Iron temperature: 380°C to 400°C
- Soldering time: 10 s max.

**Note:** The above conditions are for a PCB with OMRON's recommended patterns and hole perforations. The conditions will depend on the PCB being used. Therefore, it is recommended to double-check the suitability under actual PCB conditions.

## Soldering

Soldering temperature: Approx. 250°C (At 260°C if the DWS method is used.)

Soldering time: Approx. 5 s max. (approx. 2 s for the first time and approx. 3 s for the second time if the DWS method is used.)

Be sure to adjust the level of the molten solder so that the solder will not overflow onto the PCB.

# Precautions

## Correct Use

### Handling

Use the Relay as soon as possible after opening the moisture-proof package. If the Relay is left for a long time after opening the moisture-proof package, the appearance may suffer and seal failure may occur after the solder mounting process. To store the Relay after opening the moisture-proof package, place it into the original package and sealed the package with adhesive tape.

When washing the product after soldering the Relay to a PCB, use a water-based solvent or alcohol-based solvent, and keep the solvent temperature to less than 40°C. Do not put the Relay in a cold cleaning bath immediately after soldering.

Dropping the Relay may cause damage to its functional capability. Never use the Relay if it is dropped.

Protect the Relays from direct sunlight during operation, storage, and transportation and keep the relays under normal temperature, humidity, and pressure.

### Coating

Do not use silicone coating to coat the Relay when it is mounted to the PCB. Do not wash the PCB after the Relay is mounted using detergent containing silicone. Otherwise, the detergent may remain on the surface of the Relay.

## Claw Securing Force During Automatic Insertion

During automatic insertion of Relays, make sure to set the securing force of the claws to the following values so that the Relay characteristics will be maintained.

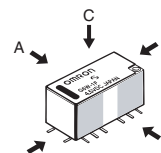

Direction A: 4.90 N max.  
Direction B: 9.80 N max.  
Direction C: 9.80 N max.

Secure the claws to the area indicated by shading. Do not attach them to the center area or to only part of the Relay.

## Latching Relay Mounting

Make sure that the vibration or shock that is generated from other devices, such as relays in operation, on the same panel and imposed on the Latching Relay does not exceed the rated value, otherwise the Latching Relay that has been set may be reset or vice versa. The Latching Relay is reset before shipping. If excessive vibration or shock is imposed, however, the Latching Relay may be set accidentally. Be sure to apply a reset signal before use.

## High-frequency Characteristics Measurement Method and Substrate to be Measured

High-frequency Characteristics for G6W are measured as shown below.

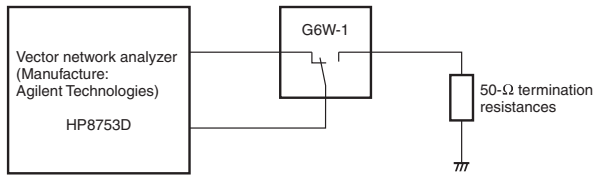

### Through-hole substrate

Substrate: t-0.8 BT resin (Dielectric constant at 2 GHz: 3.37)

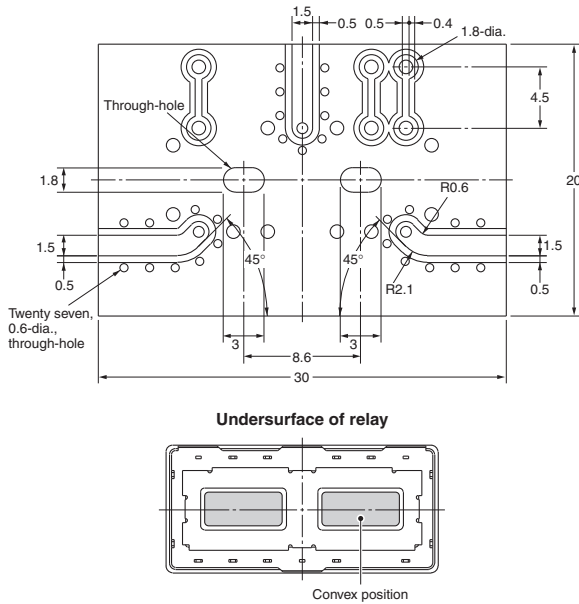

### SMD-type substrate

Substrate: t-0.8 BT resin (Dielectric constant at 2 GHz: 3.37)

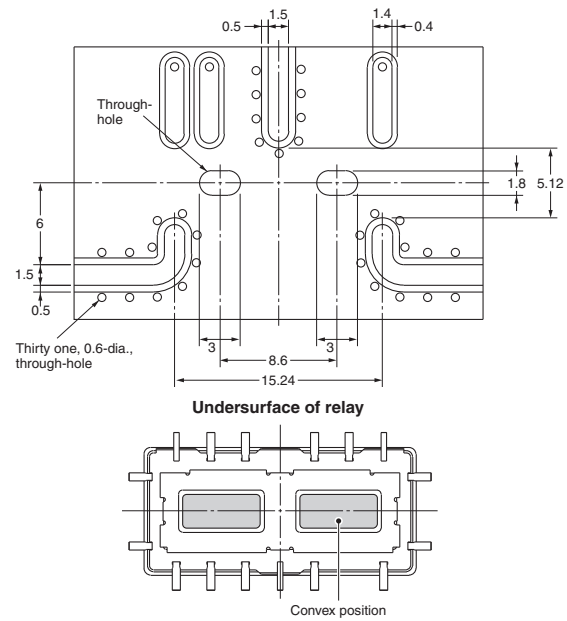

**Note:** To obtain high-frequency characteristics close to those specified in this datasheet, solder the convex point on the undersurface of the relay to the ground pattern of the substrate.

### Base plate for high-frequency characteristic compensation

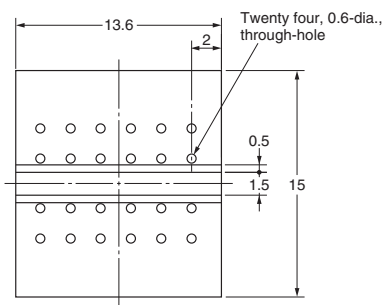

**Note:** The above compensation plate is used to measure the loss by the relay. The relay loss is determined by subtracting the data measured for a compensation base plate from those for a high-frequency characteristics measuring substrate mounted with a relay.



DISCONTINUED

OMRON

MEMO

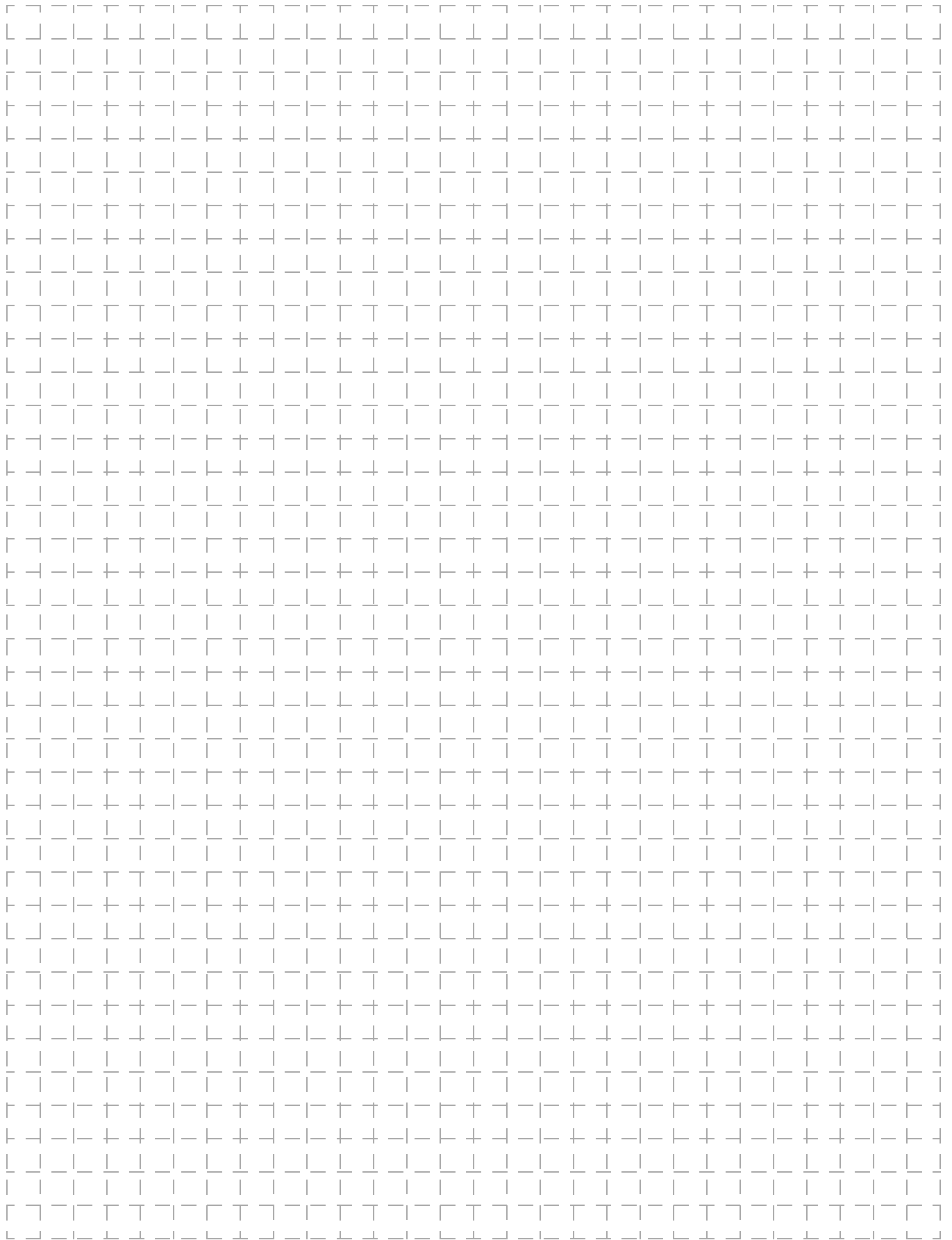

All sales are subject to Omron Electronic Components LLC standard terms and conditions of sale, which can be found at [http://www.components.omron.com/components/web/webfiles.nsf/sales\\_terms.html](http://www.components.omron.com/components/web/webfiles.nsf/sales_terms.html)

**ALL DIMENSIONS SHOWN ARE IN MILLIMETERS.**  
To convert millimeters into inches, multiply by 0.03937. To convert grams into ounces, multiply by 0.03527.

---

**OMRON**<sup>®</sup>

**OMRON ELECTRONIC  
COMPONENTS LLC**

55 E. Commerce Drive, Suite B  
Schaumburg, IL 60173

**847-882-2288**

**OMRON ON-LINE**

Global - <http://www.omron.com>

USA - <http://www.components.omron.com>

## X-ON Electronics

Largest Supplier of Electrical and Electronic Components

*Click to view similar products for [General Purpose Relays](#) category:*

*Click to view products by [Omron](#) manufacturer:*

Other Similar products are found below :

[APF30318](#) [JVN1AF-4.5V-F](#) [PCN-105D3MHZ](#) [5JO-10000S-SIL](#) [5JO-1000CD-SIL](#) [5JO-400CD-SIL](#) [LY2S-AC220/240](#) [LYQ20DC12](#)  
[6031007G](#) [6131406HQ](#) [6-1393099-3](#) [6-1393099-8](#) [6-1393122-4](#) [6-1393123-2](#) [6-1393767-1](#) [6-1393843-7](#) [6-1415012-1](#) [6-1419102-2](#) [6-](#)  
[1423698-4](#) [6-1608051-6](#) [6-1608067-0](#) [6-1616170-6](#) [6-1616248-2](#) [6-1616282-3](#) [6-1616348-2](#) [6-1616350-1](#) [6-1616350-8](#) [6-1616358-7](#) [6-](#)  
[1616359-9](#) [6-1616360-9](#) [6-1616931-6](#) [6-1617039-1](#) [6-1617052-1](#) [6-1617090-2](#) [6-1617090-5](#) [6-1617347-5](#) [6-1617353-3](#) [6-1617801-8](#) [6-](#)  
[1617802-2](#) [6-1618107-9](#) [6-1618248-4](#) [M83536/1-027M](#) [CX-4014](#) [MAHC-5494](#) [MAVCD-5419-6](#) [703XCX-120A](#) [7-1393100-5](#) [7-1393111-7](#)  
[7-1393144-5](#) [7-1393767-8](#)