

Power Relays G7Z

Multi-pole Power Relay for Carrying and Switching Contactor Current Range of 40 A at 440 VAC

- 40 A can be carried and switched on each of 4 poles.
- Possible to reach a maximum load capacity of 160 A when using 4-pole parallel connections.
- EN 60947-4-1 certification for mirror contact mechanisms has been obtained by using a combination of the relay and auxiliary contact blocks.
- Typical applications: high current or high inrush power supplies, commercial and industrial.
- RoHS compliant.

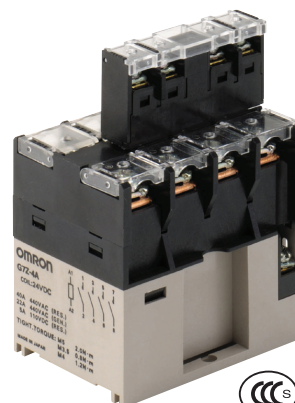

Model Number Structure

Model Number Legend

Relay with Auxiliary Contact Block

G7Z-□-□□ DC□
1 2 3 4

1. Relay Contact Configuration

- 4A: 4PST-NO
- 3A1B: 3PST-NO/SPST-NC
- 2A2B: DPST-NO/DPST-NC

2. Contact Configuration of Auxiliary Contacts

- 20: DPST-NO
- 11: SPST-NO/SPST-NC
- 02: DPST-NC

3. Contact Mechanism of Auxiliary Contacts

- Z: Bifurcated crossbar contact

4. Contact Mechanism of Auxiliary Contacts

- 12: 12 VDC
- 24: 24 VDC

Auxiliary Contact Block

G73Z-□□
1 2

1. Contact Configuration of Auxiliary Contacts

- 20: DPST-NO
- 11: SPST-NO/SPST-NC
- 02: DPST-NC

2. Contact Mechanism of Auxiliary Contacts

- Z: Bifurcated crossbar contact

Ordering Information

Classification	Structure	Contact configuration		Screw terminals (See notes 1 and 2)
		Relay	Auxiliary Contact Block	
Relay with Auxiliary Contact Block	4 poles + 2 poles	4PST-NO	DPST-NO	G7Z-4A-20Z
			SPST-NO/SPST-NC	G7Z-4A-11Z
			DPST-NC	G7Z-4A-02Z
		3PST-NO/SPST-NC	DPST-NO	G7Z-3A1B-20Z
			SPST-NO/SPST-NC	G7Z-3A1B-11Z
			DPST-NC	G7Z-3A1B-02Z
		DPST-NO/DPST-NC	DPST-NO	G7Z-2A2B-20Z
			SPST-NO/SPST-NC	G7Z-2A2B-11Z
			DPST-NC	G7Z-2A2B-02Z
Auxiliary Contact Block	2 poles	—	DPST-NO	G73Z-20Z
			SPST-NO/SPST-NC	G73Z-11Z
			DPST-NC	G73Z-02Z

Note: 1. Relay contact terminals are M5, and the coil terminals are M3.5.

2. Auxiliary contact block terminals are M3.5.

3. To Order: Select the part number and add the desired coil voltage rating (e.g., G7Z-4A-20Z DC12)

Specifications

■ Ratings

Coil Ratings

Rated voltage	Item	Rated current	Coil resistance	Must operate voltage	Must release voltage	Maximum voltage	Power consumption
12 VDC		308 mA	39 Ω	75% max.	10% min.	110%	Approx. 3.7 W
24 VDC		154 mA	156 Ω				

- Note:**
1. Rated current and coil resistance were measured at a coil temperature of 23°C with coil resistance of ±15%.
 2. Operating characteristics were measured at a coil temperature of 23°C.
 3. The maximum allowable voltage is the maximum value of the fluctuation range for the Relay coil operating power supply and was measured at an ambient temperature of 23°C. There is, however, no continuous allowance.

Contact Ratings

Relay

Item	Model	G7Z-4A-□Z, G7Z-3A1B-□Z, G7Z-2A2B-□Z		
		Resistive load	Inductive load cosφ = 0.3	Resistive load L/R = 1 ms
Contact structure		Double break		
Contact material		Ag alloy		
Rated load	NO	40 A at 440 VAC	22 A at 440 VAC	5 A at 110 VDC
	NC	25 A at 440 VAC	10 A at 440 VAC	5 A at 110 VDC
Rated carry current	NO	40 A		
	NC	25 A		
Maximum contact voltage		480 VAC		125 VDC
Maximum contact current	NO	40 A	22 A	5 A
	NC	25 A	10 A	5 A
Maximum switching capacity	NO	17,600 VA	9,680 VA	550 W
	NC	11,000 VA	4,400 VA	550 W
Minimum load		2 A at 24 VDC		

Auxiliary Contact Block

Item	Model	G73Z-20Z, G73Z-11Z, G73Z-02Z		
		Resistive load	Inductive load cosφ = 0.3	Resistive load L/R = 1 ms
Contact structure		Double break		
Contact material		Au clad + Ag		
Rated load		1 A at 440 VAC	0.5 A at 440 VAC	0.5 A at 110 VDC
Rated carry current		1 A		
Maximum contact voltage		480 VAC		125 VDC
Maximum contact current		1 A		
Maximum switching capacity		440 VA	220 VA	55 W
Minimum load		1 mA at 5 VDC		

Note: The ratings for the auxiliary contact block mounted on the G7Z are the same as those for the G73Z auxiliary contact block.

■ Characteristics

Item	Classification Model	Relay (See note 6.)	Auxiliary contact block
		G7Z-4A-□Z, G7Z-3A1B-□Z, G7Z-2A2B-□Z	G73Z-20Z, G73Z-11Z, G73Z-02Z
Contact resistance (See note 2.)		400 mΩ max.	100 mΩ max.
Operating time (See note 3.)		50 ms max.	
Release time (See note 3.)		50 ms max.	
Maximum operating frequency	Mechanical	1,800 operations/h	
	Rated load	1,200 operations/h	
Insulation resistance (See note 4.)		1,000 MΩ min.	
Dielectric strength	Between coil and contacts	4,000 VAC, 50/60 Hz for 1 min	—
	Between contacts of different polarity	4,000 VAC, 50/60 Hz for 1 min	
	Between contacts of the same polarity	2,000 VAC, 50/60 Hz for 1 min	
Impulse withstand voltage	Between coil and contacts	10 kV, 1.2 x 50 μs	—
	Between contacts of different polarity	10 kV, 1.2 x 50 μs	
	Between contacts of the same polarity	4.5 kV, 1.2 x 50 μs	
Vibration resistance	Destruction	10 to 55 to 10 Hz, 0.5-mm single amplitude (1.0-mm double amplitude)	
	Malfunction	NO: 10 to 55 to 10 Hz, 0.5-mm single amplitude (1.0-mm double amplitude) NC: 10 to 32 to 10 Hz, 0.5-mm single amplitude (1.0-mm double amplitude)	
Shock resistance	Destruction	Screw mounting: 800 m/s ² , DIN Track mounting: 500 m/s ²	
	Malfunction	NO: 100 m/s ² NO: 25 m/s ²	
Endurance	Mechanical	1,000,000 operations min. (at 1,800 operations/h, contact no load)	
	Electrical (See note 5.)	AC resistive load: 80,000 operations AC inductive load: 80,000 operations DC resistive load: 100,000 operations (at 1,200 operations/h, rated load)	
Minimum load (@ 1,800 operations/h)		2 A at 24 VDC	1 mA at 5 VDC
Ambient operating temperature		-25 to 60°C (with no icing or condensation)	
Ambient operating humidity		5% to 85%	
Weight		Approx. 330 g	Approx. 18 g

Note: 1. The above values are initial values.

- The contact resistance for the Relay (G7Z) was measured with 1 A at 5 VDC using the voltage drop method. The contact resistance for the auxiliary contact block (G73Z) was measured with 0.1 A at 5 VDC using the voltage drop method.
- The operate time was measured with the rated voltage imposed with any contact bounce ignored at the ambient temperature of 23°C.
- The insulation resistance was measured with a 1,000-VDC megohmmeter applied to the same places as those used for checking the dielectric strength.
- The electrical endurance was measured at an ambient temperature of 23°C.
- The specifications for the auxiliary contact block mounted on the G7Z are the same as those for the G73Z auxiliary contact block.

■ Approved Standards

UL Recognized (File No. E41643) -- Ambient Temp = 40°C

Model	Coil ratings	Contact ratings	Number of test operations	
G7Z	12, 24 VDC	NO contact	40 A, 480 VAC, 60 Hz (Resistive)	80,000
			5 A, 120 VDC (Resistive)	100,000
			22 A, 480 VAC, 60 Hz (General Use)	100,000
			D300* (1-A current applied)	—
		NC contact	25 A, 480 VAC, 60 Hz (Resistive)	100,000
			5 A, 120 VDC (Resistive) 10 A, 480 VAC, 60 Hz (General Use) D300* (1-A current applied)	—

*Auxiliary contact ratings

Model	Contact ratings
G73Z	NO contact
	NC contact

CSA Certification by 
 CCC Certification (File No. 2009010304361493)
 GB14048.4 

EN Standard/TÜV Certification: EN 60947-4-1
 (Certification No. R50079155) 

Model	Coil ratings	Contact ratings	
G7Z	12, 24 VDC	NO contact	AC-1: 40 A, 440 V, 50/60 Hz
			AC-3: 16 A, 440 V, 50/60 Hz
			DC-1: 5 A, 110 V
			*AC-15: 0.5 A, 440 V, 50/60 Hz *DC-13: 0.5 A, 110 V
		NC contact	AC-1: 25 A, 440 V, 50/60 Hz
			DC-1: 5 A, 110 V
			*AC-15: 0.5 A, 440 V, 50/60 Hz
			*DC-13: 0.5 A, 110 V
G73Z	—	NO contact	AC-15: 0.5 A, 440 V, 50/60 Hz
		NC contact	DC-13: 0.5 A, 110 V

*Auxiliary contact ratings

Connections

Terminal Arrangement/Internal Connections

Relay with Auxiliary Contact Block

Note: non-polarized coil.

G7Z-4A-20Z

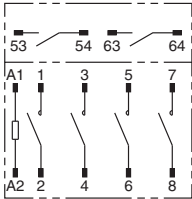

G7Z-4A-11Z

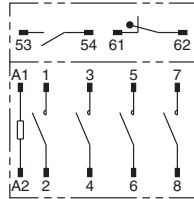

G7Z-4A-02Z

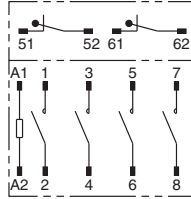

G7Z-3A1B-20Z

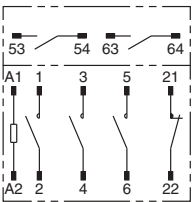

G7Z-3A1B-11Z

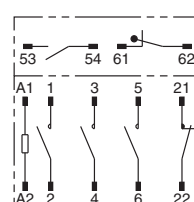

G7Z-3A1B-02Z

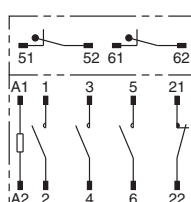

G7Z-2A2B-20Z

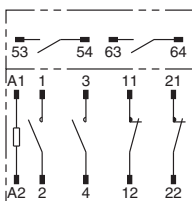

G7Z-2A2B-11Z

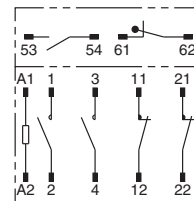

G7Z-2A2B-02Z

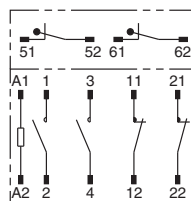

Auxiliary Contact Block

G73Z-20Z

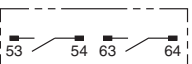

G73Z-11Z

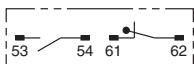

G73Z-02Z

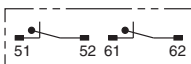

Dimensions

Note: All units are in millimeters unless otherwise indicated.

Relay (12 VDC, 24 VDC) with Auxiliary Contact Block

4 Poles

Mounting Hole Dimensions

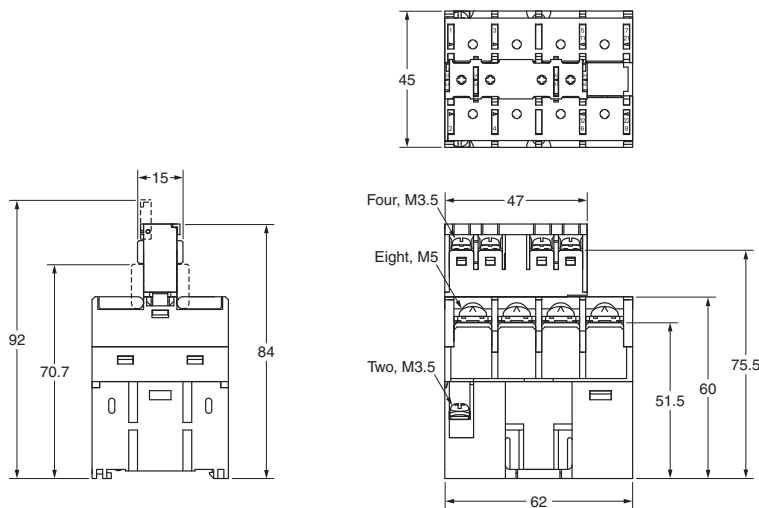
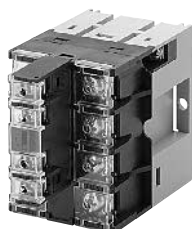

Note: The dimensions are typical values.

Auxiliary Contact Block

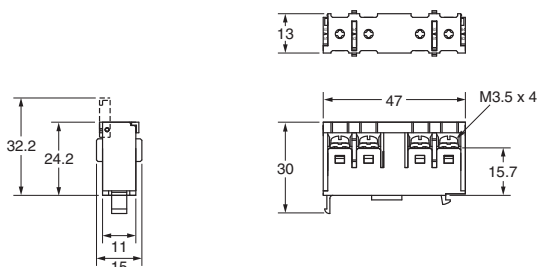

Note: The dimensions are typical values.

DIN Track Mounting Height

(when using the PFP-100N or PFP-50N mounting rail)

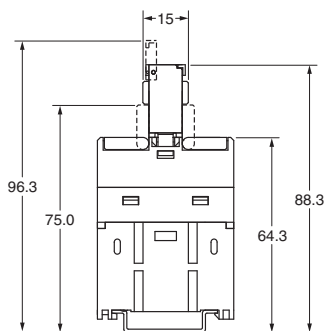

Note: The dimensions are typical values.

Precautions

Be sure to read the common precautions provided in the Technical User's Guide, "Electromechanical Relays, Technical Information" for correct use.

⚠ WARNING

Take measures to prevent contact with charged parts when using the Relay for high voltages.



⚠ CAUTION

Do not touch the terminal section (charged parts) when power is being supplied. Always use the Relay with terminal covers mounted. Contact with charged parts may result in electric shock.



Do not touch the Relay when power is being supplied or right after the power has been turned OFF. The hot surface may cause burn injury.



- Mount the Relay sideways when it is mounted on a rail.
- Use End Plates (PFP-M) on both sides of the Relay to make sure that it is properly secured.

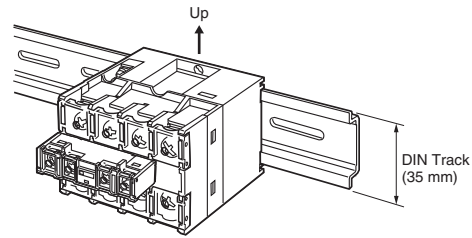

- Provide at least 5 mm of space between the sides and top of the Relay and nearby grounded metal surfaces.

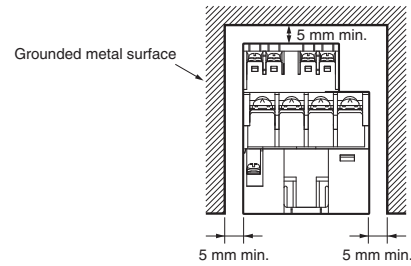

- Provide at least 30 mm of space between Relays when two or more Relays are mounted in a row.

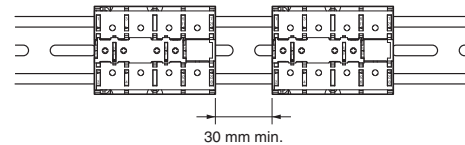

- The auxiliary contact block (G73Z) can be mounted on the Relay.

Mounting and Removal

Mounting

Insert the tab on the auxiliary contact block into the groove on the Relay and press down until the hook on the auxiliary contact block catches in the mounting hole on the Relay.

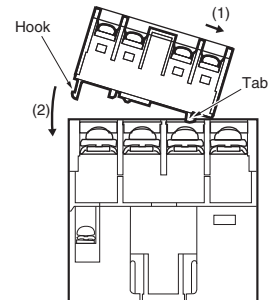

Removing

Slide the auxiliary contact block, remove the auxiliary contact block tab from the groove on the Relay, and remove the auxiliary contact block hook from the Relay.

Be careful not to apply excessive force on the hook.

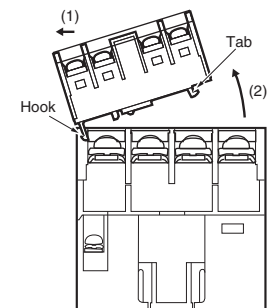

Precautions for Correct Use Installation

- Mount the G7Z with the coil terminal at the top.

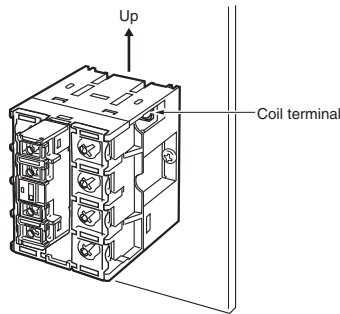

- Do not use the Relay with the terminal screw surfaces facing down.

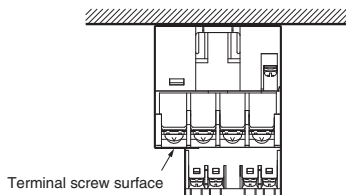

- To mount the Relay, secure M4 screws in two locations. Use a screw-tightening torque of 1.2 to 1.3 N•m.

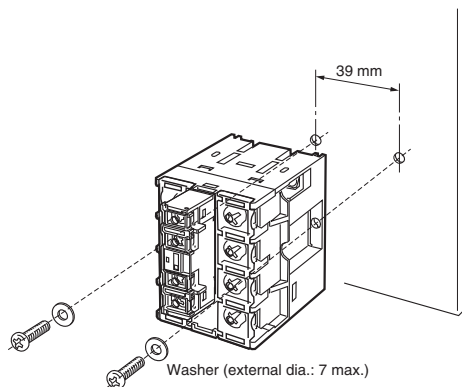

- The Relay can be mounted directly on a mounting rail (PFP) or a DIN Track (EN 50022-35 x 7.5, 15). The Relay cannot be mounted, however, to some reinforced rails (e.g., those produced by Kameda Denki or Toyogiken).

Connecting

- Use round or open-end (Y-type) crimp terminals and connect the terminals with the appropriate tightening torque. Refer to the terminal section space in the following figure for the crimp terminal dimensions.

Relay Contacts (Unit: mm)

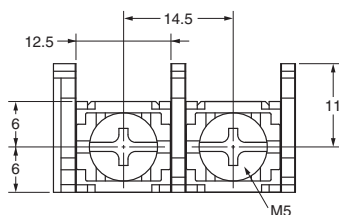

Relay Coil

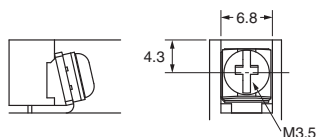

Auxiliary Contact Block

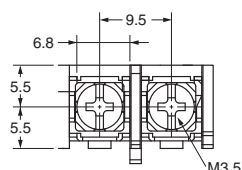

- One crimp terminal can be used for the Relay contact section (M5 screw). Two crimp terminals can be connected for the coil terminal and auxiliary contact block.

Recommended Crimp Terminals and Wire

Location	Crimp terminals	Appropriate wire size
Contact section	5.5-5	2.63 to 6.64 mm ² (AWG12, 10)
	8-5	6.64 to 10.52 mm ² (AWG8)
Coil section	1.25-3.5	0.5 to 1.65 mm ² (AWG20 to 16)

- Use the following tightening torque when tightening screws. Loose screws may result in fire caused by abnormal heat generated when the power is being supplied.
M5 screws: 2.0 to 2.2 N•m
M3.5 screws: 0.8 to 0.9 N•m
- Allow suitable slack on leads when wiring, and do not subject the terminals to excessive force.

Microloads

The G7Z is used for switching power loads, such as current carry for device power supplies and heater loads. Use an auxiliary contact block (G73Z) if microloads are required for signal applications and operation status feedback.

Operating Coil

(Internal Connections of Coils)

DC Coil

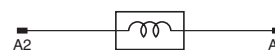

- If a transistor drives the G7Z, check the leakage current and connect a bleeder resistor if necessary.
- The must operate voltage is the minimum value for the Relay armature to operate and the contacts to turn ON. Therefore, fundamentally apply the rated voltage to the coils, taking into consideration the increases in coil resistance caused by voltage fluctuation and coil temperature rise.

Mirror Contact Mechanism

By combining a Relay with an auxiliary contact block, all NC contacts of the auxiliary contact block will satisfy an impulse withstand voltage of more than 2.5 kV or maintain a gap of more than 0.5 mm when the coil is de-energized even if at least one NO contact (main contact) of the Relay is welded (according to EN 60947-4-1).

Description of Mirror Contact Mechanism

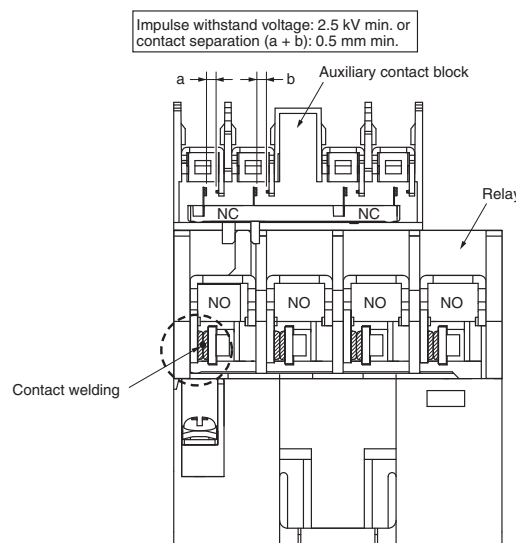

All sales are subject to Omron Electronic Components LLC standard terms and conditions of sale, which can be found at http://www.components.omron.com/components/web/webfiles.nsf/sales_terms.html

ALL DIMENSIONS SHOWN ARE IN MILLIMETERS.
To convert millimeters into inches, multiply by 0.03937. To convert grams into ounces, multiply by 0.03527.

OMRON[®]

**OMRON ELECTRONIC
COMPONENTS LLC**

55 E. Commerce Drive, Suite B
Schaumburg, IL 60173

847-882-2288

OMRON ON-LINE

Global - <http://www.omron.com>

USA - <http://www.components.omron.com>

Cat. No. X301-E-1b

09/11

Specifications subject to change without notice

Printed in USA

X-ON Electronics

Largest Supplier of Electrical and Electronic Components

Click to view similar products for [General Purpose Relays](#) category:

Click to view products by [Omron](#) manufacturer:

Other Similar products are found below :

[PCN-105D3MH,000](#) [59641F200](#) [LY1SAC110120](#) [5X827E](#) [5X837F](#) [5X840F](#) [5X842F](#) [5X848E](#) [LY2N-AC120](#) [LY2S-AC220/240](#) [LY2-US-AC120](#) [LY3-US-AC120](#) [LY4F-UA-DC12](#) [LY4F-UA-DC24](#) [LY4F-US-AC120](#) [LY4F-US-AC240](#) [LY4F-US-DC24](#) [LY4F-VD-AC110](#) [LYQ20DC12](#) [M115C60](#) [M115N010](#) [M115N0150](#) [6031007G](#) [603-12D](#) [61211T0B4](#) [61212T400](#) [61222Q400](#) [61243B600](#) [61243C500](#) [61243Q400](#) [61311BOA2](#) [61311BOA6](#) [61311BOA8](#) [61311C0A2](#) [61311COA1](#) [61311COA6](#) [61311F0A2](#) [61311QOA1](#) [61311QOA4](#) [61311T0D6](#) [61311TOA6](#) [61311TOA7](#) [61311TOB3](#) [61311TOB4](#) [61311U0A6](#) [61312Q600](#) [61312T400](#) [61312T600](#) [61313U200](#) [61313U400](#)