

Power Relays

G7Z

Compact Electromagnetic Contactors That Switch 40 A at 440 VAC

- One pole carries 40 A.
UL 508 and UL 840 NO contacts
(resistive 40 A 480 VAC, 60 Hz, 80,000 operations).
EN 60947-4-1 NO contacts
(AC1 40 A 440 VAC, 50/60 Hz, 80,000 operations).
- Ideal for supply power to industrial inverters, servo drivers, and other devices, and switching power to motors and other equipment.
- The maximum load capacity of 160 A when using 4-pole parallel connections.
- EN 60947-4-1 certification for mirror contact mechanism obtained by combining the Relay with an Auxiliary Contact Block.
- Conforms to European PV standard (VDE0126).
- Approx. 30% less operation noise than a standard electromagnetic contactor.*
(Approx. 100 dB reduced to approx. 70 dB.)
- Approx. 50% the volume of a standard electromagnetic contactor* to help downsize control panels.

* According to OMRON investigation of IIEC-AC1 50 A specifications.

 Be sure to read the *Safety Precautions* on page 8 and the *"Precautions for All Relays with Forcibly Guided Contacts"*.



For the most recent information on models that have been certified for safety standards, refer to your OMRON website.

Model Number Structure

Model Number Legend

Relay with Auxiliary Contact Block

G7Z-□-□□-□
1 2 3

1. Relay Contact Configuration

- 4A: 4PST-NO
- 3A1B: 3PST-NO/SPST-NC
- 2A2B: DPST-NO/DPST-NC

2. Contact Configuration of Auxiliary Contacts

- 20: DPST-NO
- 11: SPST-NO/SPST-NC
- 02: DPST-NC

3. Contact Mechanism of Auxiliary Contacts

- Z-R: Bifurcated crossbar contact
(Single break)

Relay

G7Z-□
1

1. Contact Configuration

- 4A: 4PST-NO
- 3A1B: 3PST-NO/SPST-NC
- 2A2B: DPST-NO/DPST-NC

Auxiliary Contact Block

G73Z-□□-□
1 2

1. Contact Configuration of Auxiliary Contacts

- 20: DPST-NO
- 11: SPST-NO/SPST-NC
- 02: DPST-NC

2. Contact Mechanism of Auxiliary Contacts

- Z-R: Bifurcated crossbar contact
(Single break)

G7Z

Ordering Information When your order, specify the rated voltage.

Relay with Auxiliary Contact Block

Number of poles (Relay with Auxiliary Contact)	Contact configuration		Model	Rated Voltage
	Relay	Auxiliary Contact Block		
4 poles + 2 poles	4PST-NO	DPST-NO	G7Z-4A-20Z-R	12, 24 VDC
		SPST-NO/SPST-NC	G7Z-4A-11Z-R	12, 24 VDC
		DPST-NC	G7Z-4A-02Z-R	12, 24 VDC
	3PST-NO/SPST-NC	DPST-NO	G7Z-3A1B-20Z-R	12, 24 VDC
		SPST-NO/SPST-NC	G7Z-3A1B-11Z-R	12, 24 VDC
		DPST-NC	G7Z-3A1B-02Z-R	12, 24 VDC
	DPST-NO/DPST-NC	DPST-NO	G7Z-2A2B-20Z-R	12, 24 VDC
		SPST-NO/SPST-NC	G7Z-2A2B-11Z-R	12, 24 VDC
		DPST-NC	G7Z-2A2B-02Z-R	12, 24 VDC

- Note:** 1. Relay contact terminals are M5, and the coil terminals are M3.5.
 2. Auxiliary contact block terminals are M3.5.
 3. When placing an order, specify the model number and rated supply voltage (12 VDC or 24 VDC).

Relay

Number of poles	Contact configuration	Model	Rated Voltage
4 poles	4PST-NO	G7Z-4A	12, 24 VDC
	3PST-NO/SPST-NC	G7Z-3A1B	
	DPST-NO/DPST-NC	G7Z-2A2B	

- Note:** 1. Relay contact terminals are M5, and the coil terminals are M3.5.
 2. When placing an order, specify the model number and rated supply voltage (12 VDC or 24 VDC).

Accessories (Order Separately)

Auxiliary Contact Block

Number of poles	Contact Configuration	Model
2 poles	DPST-NO	G73Z-20Z-R
	SPST-NO/SPST-NC	G73Z-11Z-R
	DPST-NC	G73Z-02Z-R

- Note:** Auxiliary contact block terminals are M3.5.

Specifications

Ratings

Coil

Item	Rated current (mA)	Coil resistance (Ω)	Must operate voltage	Must release voltage	Maximum voltage	Power consumption (W)
			Percentage of rated voltage			
12 VDC	308	39	75% max.	10% min.	110%	Approx. 3.7
24 VDC	154	156				

- Note:**
- Rated current and coil resistance were measured at a coil temperature of 23°C with coil resistance of $\pm 15\%$.
 - Operating characteristics were measured at a coil temperature of 23°C.
 - The maximum allowable voltage is the maximum value of the fluctuation range for the Relay coil operating power supply and was measured at an ambient temperature of 23°C.
There is, however, no continuous allowance.

Contacts

Relay, Relay with Auxiliary Contact Block

Item	Model Load	G7Z-4A-□Z-R, G7Z-3A1B-□Z-R, G7Z-2A2B-□Z-R		
		Resistive load	Inductive load $\cos\phi = 0.3$	Resistive load L/R = 1 ms
Contact structure		Double break		
Contact material		Ag alloy		
Rated load	NO	40 A at 440 VAC	22 A at 440 VAC	5 A at 110 VDC
	NC	25 A at 440 VAC	10 A at 440 VAC	5 A at 110 VDC
Rated carry current	NO	40 A *		
	NC	25 A		
Maximum contact voltage		480 VAC		125 VDC
Maximum contact current	NO	40 A	22 A	5 A
	NC	25 A	10 A	5 A
Maximum switching capacity	NO	17,600 VA	9,680 VA	550 W
	NC	11,000 VA	4,400 VA	550 W
Failure rate P value (reference value)		2 A at 24 VDC		

- Note:** The ratings for the auxiliary contact block mounted on the G7Z are the same as those for the G73Z auxiliary contact block.
* Set of Relay and Auxiliary Contact Block: 45 to 60°C; for the continuous carry current, reduce 40 A by 0.7 A/°C.

Auxiliary Contact Block

Item	Model Load	G73Z-20Z-R, G73Z-11Z-R, G73Z-02Z-R		
		Resistive load	Inductive load $\cos\phi = 0.3$	Resistive load L/R = 1 ms
Contact structure		Single break		
Contact material		Au clad + AgNi		
Rated load		1 A at 440 VAC	0.5 A at 440 VAC	0.5 A at 110 VDC
Rated carry current		1 A		
Maximum contact voltage		480 VAC		125 VDC
Maximum contact current		1 A	0.5 A	
Maximum switching capacity		440 VA	220 VA	55 W
Failure rate P value (reference value)		1 mA at 1 VDC		

Characteristics

Item	Classification	Relay with auxiliary contact block *5	Auxiliary contact block
	Model	G7Z-4A-□Z-R, G7Z-3A1B-□Z-R, G7Z-2A2B-□Z-R	G73Z-20Z-R, G73Z-11Z-R, G73Z-02Z-R
Contact resistance *1		400 mΩ max.	100 mΩ max.
Operating time *2		50 ms max.	
Release time *2		50 ms max.	
Maximum operating frequency	Mechanical	1,800 operations/h	
	Rated load	1,200 operations/h	
Insulation resistance *3		1,000 MΩ min.	
Dielectric strength	Between coil and contacts	4,000 VAC, 50/60 Hz for 1 min	---
	Between contacts of different polarity	4,000 VAC, 50/60 Hz for 1 min	
	Between contacts of the same polarity	2,000 VAC, 50/60 Hz for 1 min	
Impulse withstand voltage	Between coil and contacts	10 kV, 1.2 × 50 μs	---
	Between contacts of different polarity	10 kV, 1.2 × 50 μs	
	Between contacts of the same polarity	4.5 kV, 1.2 × 50 μs	3.0 kV, 1.2 × 50 μs
Vibration resistance	Destruction	10 to 55 to 10 Hz, 0.5-mm single amplitude (1.0-mm double amplitude)	
	Malfunction	NO: 10 to 55 to 10 Hz, 0.5-mm single amplitude (1.0-mm double amplitude) NC: 10 to 32 to 10 Hz, 0.5-mm single amplitude (1.0-mm double amplitude)	
Shock resistance	Destruction	Screw mounting: 700 m/s ² , DIN Track mounting: 500 m/s ²	
	Malfunction	NO: 100 m/s ² NC: 25 m/s ²	
Durability	Mechanical	1,000,000 operations min. (at 1,800 operations/h, contact no load)	
	Electrical *4	AC resistive load: 80,000 operations AC inductive load: 80,000 operations DC resistive load: 100,000 operations (at 1,200 operations/h, rated load)	
Failure rate (P level) (reference value) *6		2 A at 24 VDC	1 mA at 1 VDC
Ambient operating temperature		-25 to 60°C (with no icing or condensation)	
Ambient operating humidity		5% to 85%	
Weight		Approx. 330 g	Approx. 18 g

Note: The above values are initial values.

*1. The contact resistance for the Relay (G7Z) was measured with 1 A at 5 VDC using the voltage drop method.

The contact resistance for the auxiliary contact block (G73Z) was measured with 0.1 A at 5 VDC using the voltage drop method.

*2. The operate time was measured with the rated voltage imposed with any contact bounce ignored at the ambient temperature of 23°C.

*3. The insulation resistance was measured with a 1,000-VDC megohmmeter applied to the same places as those used for checking the dielectric strength.

*4. The electrical endurance was measured at an ambient temperature of 23°C.

*5. The specifications for the auxiliary contact block mounted on the G7Z are the same as those for the G73Z auxiliary contact block.

*6. The failure rate is based on an operating frequency of 1,800 operations/h.

Approved Standards

UL Standard: UL508, UL840 (File No. E41643)

Classification	Contact Mechanism of Auxiliary Contacts	Model	Number of poles	Contact ratings			Number of test operations	Coil ratings	Category	Listed/ Recognized
				Contact	Relay	Relay				
Relay with Auxiliary Contact Block	Single-break models	G7Z-4A-20Z-R G7Z-4A-11Z-R G7Z-4A-02Z-R G7Z-3A1B-20Z-R G7Z-3A1B-11Z-R G7Z-3A1B-02Z-R G7Z-2A2B-20Z-R G7Z-2A2B-11Z-R G7Z-2A2B-02Z-R	4 poles + 2 poles (Relay unit + auxiliary contact)	NO contact	Relay	40 A, 480 VAC, 60 Hz (Resistive)	80,000	12, 24 VDC	NLDX2, NLDX8	Recognized
					Auxiliary Contact	D300 (1-A current applied)	---			
				NC contact	Relay	25 A, 480 VAC, 60 Hz (Resistive) 5 A, 120 VDC (Resistive) 10 A, 480 VAC, 60 Hz (General Use)	100,000			
					Auxiliary Contact	D300 (1-A current applied)	---			
Relay	---	G7Z-4A G7Z-3A1B G7Z-2A2B	4 poles (Relay)	NO contact	(Relay)	40 A, 480 VAC, 60 Hz (Resistive)	80,000	12, 24 VDC	NLDX2, NLDX8	Recognized
						5 A, 120 VDC (Resistive)	100,000			
						22 A, 480 VAC, 60 Hz (General Use)	100,000			
				NC contact		25 A, 480 VAC, 60 Hz (General Use)	100,000			
						5 A, 120 VDC (Resistive)				
10 A, 480 VAC, 60 Hz (General Use)										
Auxiliary Contact Block	Single-break models	G73Z-20Z-R G73Z-11Z-R G73Z-02Z-R	2 poles (Auxiliary Contact Block)	NO contact	(Auxiliary Contact)	D300 (1-A current applied)	---	---	NLDX2, NLDX8	Recognized
				NC contact		D300 (1-A current applied)				

CSA Standard: CSA Certification by cUL: CSA C22.2 No. 14

EN Standard/TÜV Certification: EN 60947-4-1 (Certification No. R50079155)

Category	Contact Mechanism of Auxiliary Contacts	Model	Number of poles	Contact ratings		
				Contact	Relay	Relay
Relay with Auxiliary Contact Block	Single-break models	G7Z-4A-20Z-R G7Z-4A-11Z-R G7Z-4A-02Z-R G7Z-3A1B-20Z-R G7Z-3A1B-11Z-R G7Z-3A1B-02Z-R G7Z-2A2B-20Z-R G7Z-2A2B-11Z-R G7Z-2A2B-02Z-R	4 poles + 2 poles (Relay unit + auxiliary contact)	NO contact	Relay	AC-1 : 40 A 440 V 50/60 Hz AC-3 : 16 A 440 V 50/60 Hz DC-1 : 5 A 110 V
					Auxiliary Contact	AC-15 : 0.3 A 440 V 50/60 Hz DC-13 : 0.3 A 110 V
				NC contact	Relay	AC-1 : 25 A 440 V 50/60 Hz DC-1 : 5 A 110 V
					Auxiliary Contact	AC-15 : 0.3 A 440 V 50/60 Hz DC-13 : 0.3 A 110 V
Relay	---	G7Z-4A G7Z-3A1B G7Z-2A2B	4 poles (Relay)	NO contact	(Relay)	AC-1 : 40 A 440 V 50/60 Hz AC-3 : 16 A 440 V 50/60 Hz DC-1 : 5 A 110 V
				NC contact		AC-1 : 25 A 440 V 50/60 Hz DC-1 : 5 A 110 V
Auxiliary Contact Block	Single-break models	G73Z-20Z-R G73Z-11Z-R G73Z-02Z-R	2 poles (Auxiliary Contact Block)	NO contact	(Auxiliary Contact)	AC-15 : 0.3 A 440 V 50/60 Hz DC-13 : 0.3 A 110 V
				NC contact		AC-15 : 0.3 A 440 V 50/60 Hz DC-13 : 0.3 A 110 V

CCC Certification

Classification	Contact Mechanism of Auxiliary Contacts	Model	Standard No.	Certification No.
Relay with Auxiliary Contact Block	Single-break models	G7Z-4A-20Z-R G7Z-4A-11Z-R G7Z-4A-02Z-R G7Z-3A1B-20Z-R G7Z-3A1B-11Z-R G7Z-3A1B-02Z-R G7Z-2A2B-20Z-R G7Z-2A2B-11Z-R G7Z-2A2B-02Z-R	GB/T 14048.4	2009010304361493
Relay	---	G7Z-4A G7Z-3A1B G7Z-2A2B	GB/T 14048.4	

G7Z

Dimensions

(Unit: mm)

Relay (12 VDC, 24 VDC) with Auxiliary Contact Block

4 poles + 2 poles (Relay with Auxiliary Contact)

G7Z-4A-□Z-R

G7Z-3A1B-□Z-R

G7Z-2A2B-□Z-R

Mounting Hole Dimensions

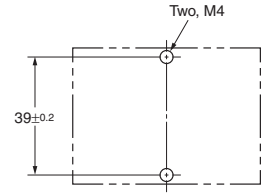
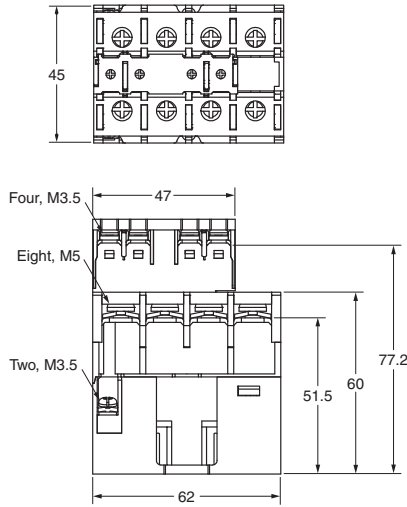
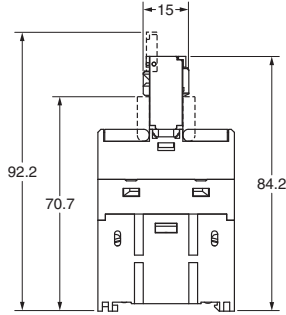

Note: The dimensions are typical values.

Relay (12 VDC, 24 VDC)

4 Poles

Mounting Hole Dimensions

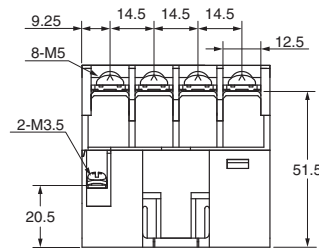
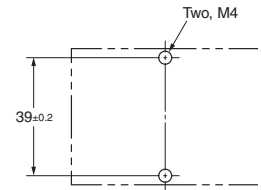
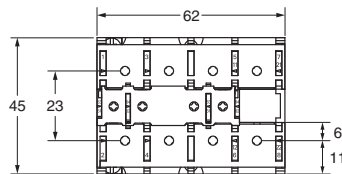
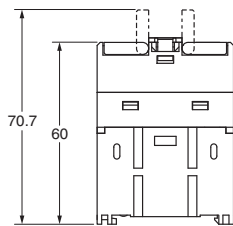

Note: The dimensions are typical values.

Contact Block

G73Z-□Z-R

Auxiliary DIN Track Mounting Height

(when using the PFP-100N or PFP-50N mounting rail)

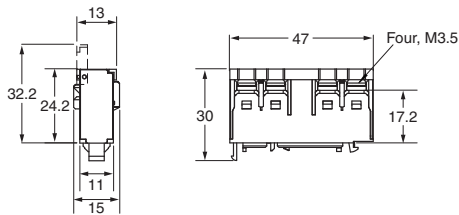

Note: The dimensions are typical values.

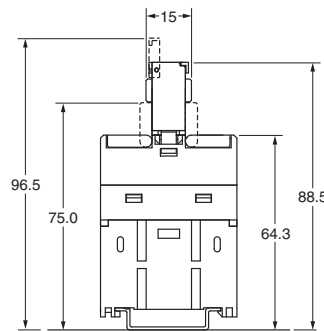

Note: The dimensions are typical values.

Terminal Arrangement/Internal Connections

Relay with Auxiliary Contact Block

G7Z-4A-20Z-R

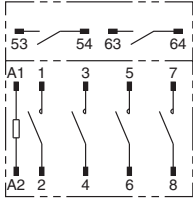

Note: The coil has no polarity.

G7Z-4A-11Z-R

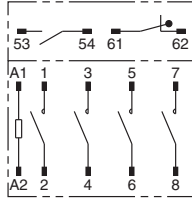

Note: The coil has no polarity.

G7Z-4A-02Z-R

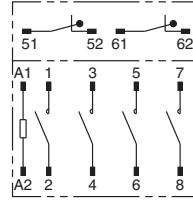

Note: The coil has no polarity.

G7Z-3A1B-20Z-R

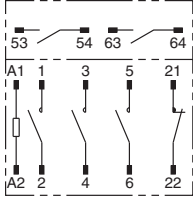

Note: The coil has no polarity.

G7Z-3A1B-11Z-R

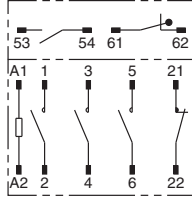

Note: The coil has no polarity.

G7Z-3A1B-02Z-R

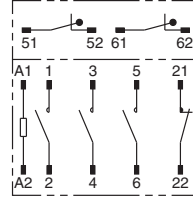

Note: The coil has no polarity.

G7Z-2A2B-20Z-R

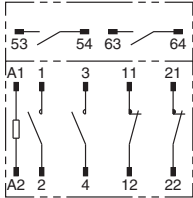

Note: The coil has no polarity.

G7Z-2A2B-11Z-R

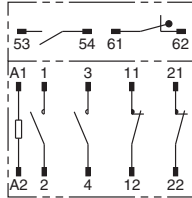

Note: The coil has no polarity.

G7Z-2A2B-02Z-R

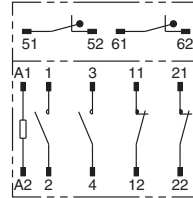

Note: The coil has no polarity.

Auxiliary Contact Block

G73Z-20Z-R



G73Z-11Z-R



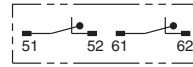

G73Z-02Z-R





Safety Precautions

Be sure to read the precautions “*Precautions for All Relays*” and “*Precautions for All Relays with Forcibly Guided Contacts*” in the website at:<http://www.ia.omron.com/>.

Indication and Meaning for Safe Use

 WARNING	Indicates a potentially hazardous situation which, if not avoided, will result in minor or moderate injury, or may result in serious injury or death. Additionally there may be significant property damage.
 CAUTION	Indicates a potentially hazardous situation which, if not avoided, may result in minor or moderate injury or in property damage.
Precautions for Correct Use	Supplementary comments on what to do or avoid doing, to prevent failure to operate, or undesirable effect on product performance.

Meaning of Product Safety Symbols

	Indicates unspecified general alert (Can be used as Alert Symbol, too)
	Indicates the possibility of electric shock under specific conditions.
	Indicates the possibility of injuries by high temperature under specific conditions.

! WARNING

Take measures to prevent contact with charged parts when using the Relay for high voltages.



! CAUTION

Do not touch the terminal section (charged parts) when power is being supplied.
Always use the Relay with terminal covers mounted.
Contact with charged parts may result in electric shock.



Do not touch the Relay when power is being supplied or right after the power has been turned OFF.
The hot surface may cause burn injury.



Precautions for Correct Use

Installation

- Mount the G7Z with the coil terminal at the top.

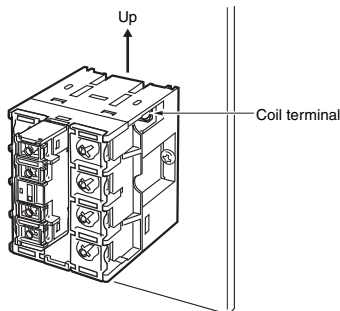

- Do not use the Relay with the terminal screw surfaces facing down.

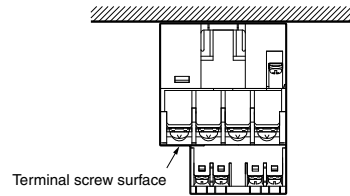

- To mount the Relay, secure M4 screws in two locations. Use a screw-tightening torque of 1.2 to 1.3 N·m.

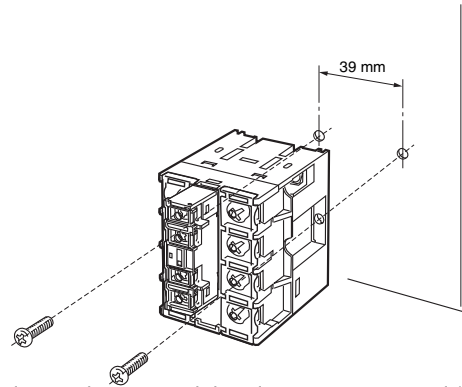

- The Relay can be mounted directly on a mounting rail (PFP) or a DIN Track (EN 50022-35 × 7.5, 15). The Relay cannot be mounted, however, to some reinforced rails (e.g., those produced by Kameda Denki or Toyogiken).
- Mount the Relay sideways when it is mounted on a rail.
- Use End Plates (PFP-M) on both sides of the Relay to make sure that it is properly secured.

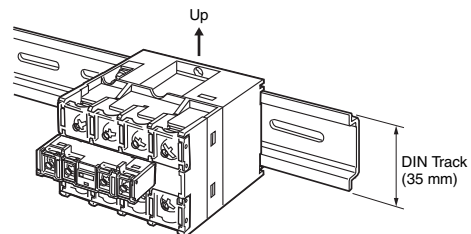

- Provide at least 5 mm of space between the sides and top of the Relay and nearby grounded metal surfaces.

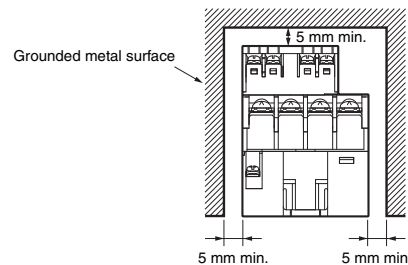

- Provide at least 30 mm of space between Relays when two or more Relays are mounted in a row.

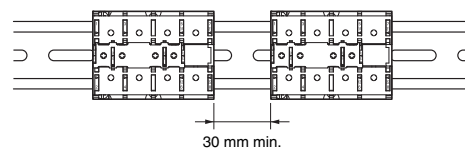

- The auxiliary contact block can be mounted on the Relay.

Mounting and Removal

Mounting

Insert the tab on the auxiliary contact block into the groove on the Relay and press down until the hook on the auxiliary contact block catches in the mounting hole on the Relay.

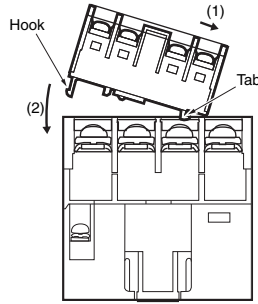

Removing

Slide the auxiliary contact block, remove the auxiliary contact block tab from the groove on the Relay, and remove the auxiliary contact block hook from the Relay.

Be careful not to apply excessive force on the hook.

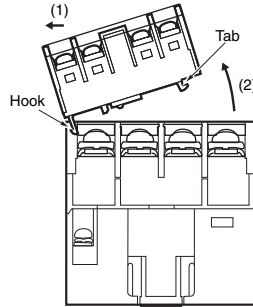

Connecting

- Use round or open-end (Y-type) crimp terminals and connect the terminals with the appropriate tightening torque. Refer to the terminal section space in the following figure for the crimp terminal dimensions.

Relay Contacts (Unit: mm)

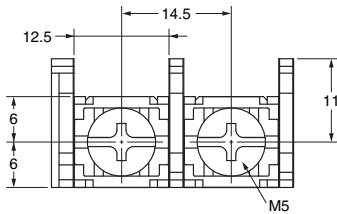

Relay Coil

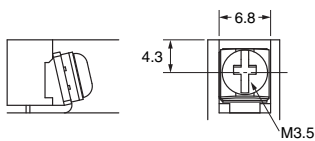

Auxiliary Contact Block

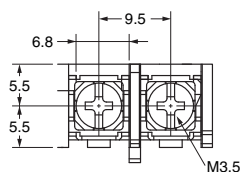

- One crimp terminal can be used for the Relay contact section (M5 screw). Two crimp terminals can be connected for the coil terminal and auxiliary contact block.

Recommended Crimp Terminals and Wire

Location	Crimp terminals	Appropriate wire size
Contact section	5.5-5	2.63 to 6.64 mm ² (AWG12, 10)
	8-5	6.64 to 10.52 mm ² (AWG8)
Coil section	1.25-3.5	0.5 to 1.65 mm ² (AWG20 to 16)

- Use the following tightening torque when tightening screws. Loose screws may result in fire caused by abnormal heat generated when the power is being supplied.
 M5 screws: 2.0 to 2.2 N·m
 M3.5 screws: 0.8 to 0.9 N·m
- Allow suitable slack on leads when wiring, and do not subject the terminals to excessive force.

Microloads

The G7Z is used for switching power loads, such as current carry for device power supplies and heater loads. Use an auxiliary contact block if microloads are required for signal applications and operation status feedback.

Coil

(Internal Connections of Coils)

DC Coil

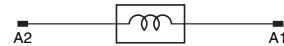

- If a transistor drives the G7Z, check the leakage current and connect a bleeder resistor if necessary.
- The must operate voltage is the minimum value for the Relay armature to operate and the contacts to turn ON. Therefore, fundamentally apply the rated voltage to the coils, taking into consideration the increases in coil resistance caused by voltage fluctuation and coil temperature rise.
- Counter-electromotive voltage generated by the coil when the coil is OFF may destroy semiconductor elements or cause malfunctions. Attach surge-absorbing diodes to both ends of the coil as a countermeasure. Particularly, when driving G7Z with semiconductor elements, always attach the surge-absorbing diodes.
 Note that the relay reset time will be extended, so always use after verifying implementation under actual usage conditions.
 Use surge-absorbing diodes with a minimum of 600 V reverse voltage resistance, and a forward current of approximately 1A.
 G7Z does not have coil polarity so attach surge-absorbing diodes so that the polarity is reverse to the applied voltage of the coil.

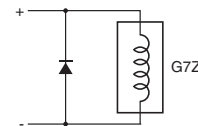

Mirror Contact Mechanism

By combining a Relay with an auxiliary contact block, all NC contacts of the auxiliary contact block will satisfy an impulse withstand voltage of 2.5 kV or higher or maintain a gap of 0.5 mm or greater when the coil is de-energized even if at least one NO contact (main contact) of the Relay is welded.

Description of Mirror Contact Mechanism

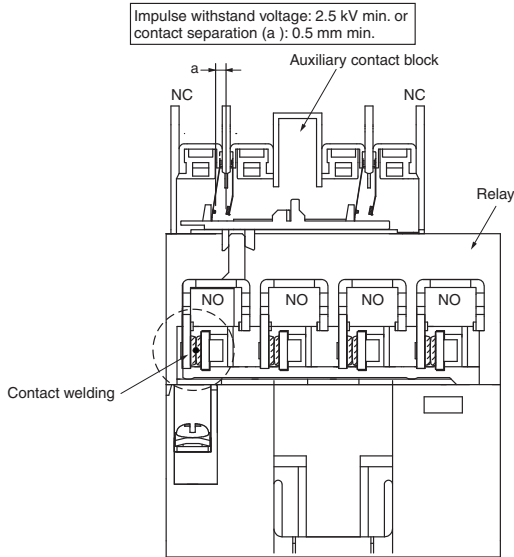

Safety Function with Mirror Contacts

EN 60947-4-1 certification for mirror contact mechanisms has been obtained by using a combination of a relay and auxiliary contact blocks, enabling application in feedback circuits of safety circuits.

Application Example: General Safety Circuit

G9SA-301 (24-V AC/DC) (two limit switch input channels with manual reset)

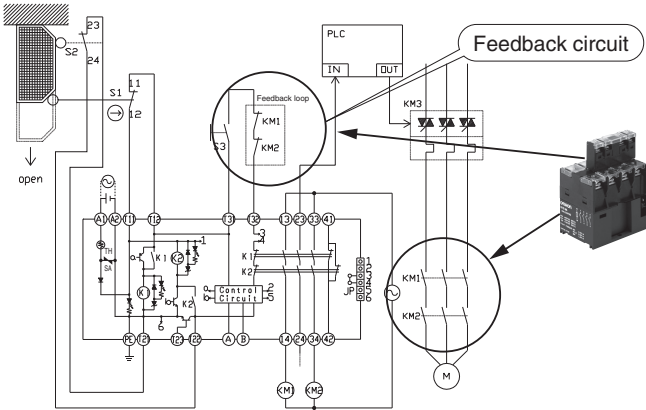

Terms and Conditions Agreement

Read and understand this catalog.

Please read and understand this catalog before purchasing the products. Please consult your OMRON representative if you have any questions or comments.

Warranties.

- (a) Exclusive Warranty. Omron's exclusive warranty is that the Products will be free from defects in materials and workmanship for a period of twelve months from the date of sale by Omron (or such other period expressed in writing by Omron). Omron disclaims all other warranties, express or implied.
- (b) Limitations. OMRON MAKES NO WARRANTY OR REPRESENTATION, EXPRESS OR IMPLIED, ABOUT NON-INFRINGEMENT, MERCHANTABILITY OR FITNESS FOR A PARTICULAR PURPOSE OF THE PRODUCTS. BUYER ACKNOWLEDGES THAT IT ALONE HAS DETERMINED THAT THE PRODUCTS WILL SUITABLY MEET THE REQUIREMENTS OF THEIR INTENDED USE.

Omron further disclaims all warranties and responsibility of any type for claims or expenses based on infringement by the Products or otherwise of any intellectual property right. (c) Buyer Remedy. Omron's sole obligation hereunder shall be, at Omron's election, to (i) replace (in the form originally shipped with Buyer responsible for labor charges for removal or replacement thereof) the non-complying Product, (ii) repair the non-complying Product, or (iii) repay or credit Buyer an amount equal to the purchase price of the non-complying Product; provided that in no event shall Omron be responsible for warranty, repair, indemnity or any other claims or expenses regarding the Products unless Omron's analysis confirms that the Products were properly handled, stored, installed and maintained and not subject to contamination, abuse, misuse or inappropriate modification. Return of any Products by Buyer must be approved in writing by Omron before shipment. Omron Companies shall not be liable for the suitability or unsuitability or the results from the use of Products in combination with any electrical or electronic components, circuits, system assemblies or any other materials or substances or environments. Any advice, recommendations or information given orally or in writing, are not to be construed as an amendment or addition to the above warranty.

See <http://www.omron.com/global/> or contact your Omron representative for published information.

Limitation on Liability; Etc.

OMRON COMPANIES SHALL NOT BE LIABLE FOR SPECIAL, INDIRECT, INCIDENTAL, OR CONSEQUENTIAL DAMAGES, LOSS OF PROFITS OR PRODUCTION OR COMMERCIAL LOSS IN ANY WAY CONNECTED WITH THE PRODUCTS, WHETHER SUCH CLAIM IS BASED IN CONTRACT, WARRANTY, NEGLIGENCE OR STRICT LIABILITY.

Further, in no event shall liability of Omron Companies exceed the individual price of the Product on which liability is asserted.

Suitability of Use.

Omron Companies shall not be responsible for conformity with any standards, codes or regulations which apply to the combination of the Product in the Buyer's application or use of the Product. At Buyer's request, Omron will provide applicable third party certification documents identifying ratings and limitations of use which apply to the Product. This information by itself is not sufficient for a complete determination of the suitability of the Product in combination with the end product, machine, system, or other application or use. Buyer shall be solely responsible for determining appropriateness of the particular Product with respect to Buyer's application, product or system. Buyer shall take application responsibility in all cases.

NEVER USE THE PRODUCT FOR AN APPLICATION INVOLVING SERIOUS RISK TO LIFE OR PROPERTY OR IN LARGE QUANTITIES WITHOUT ENSURING THAT THE SYSTEM AS A WHOLE HAS BEEN DESIGNED TO ADDRESS THE RISKS, AND THAT THE OMRON PRODUCT(S) IS PROPERLY RATED AND INSTALLED FOR THE INTENDED USE WITHIN THE OVERALL EQUIPMENT OR SYSTEM.

Programmable Products.

Omron Companies shall not be responsible for the user's programming of a programmable Product, or any consequence thereof.

Performance Data.

Data presented in Omron Company websites, catalogs and other materials is provided as a guide for the user in determining suitability and does not constitute a warranty. It may represent the result of Omron's test conditions, and the user must correlate it to actual application requirements. Actual performance is subject to the Omron's Warranty and Limitations of Liability.

Change in Specifications.

Product specifications and accessories may be changed at any time based on improvements and other reasons. It is our practice to change part numbers when published ratings or features are changed, or when significant construction changes are made. However, some specifications of the Product may be changed without any notice. When in doubt, special part numbers may be assigned to fix or establish key specifications for your application. Please consult with your Omron's representative at any time to confirm actual specifications of purchased Product.

Errors and Omissions.

Information presented by Omron Companies has been checked and is believed to be accurate; however, no responsibility is assumed for clerical, typographical or proofreading errors or omissions.

OMRON Corporation Industrial Automation Company
Kyoto, JAPAN

Contact: www.ia.omron.com

Regional Headquarters

OMRON EUROPE B.V.

Wegalaan 67-69, 2132 JD Hoofddorp
The Netherlands
Tel: (31)2356-81-300/Fax: (31)2356-81-388

OMRON ELECTRONICS LLC

2895 Greenspoint Parkway, Suite 200
Hoffman Estates, IL 60169 U.S.A.
Tel: (1) 847-843-7900/Fax: (1) 847-843-7787

OMRON ASIA PACIFIC PTE. LTD.

No. 438A Alexandra Road # 05-05/08 (Lobby 2),
Alexandra Technopark,
Singapore 119967
Tel: (65) 6835-3011/Fax: (65) 6835-2711

OMRON (CHINA) CO., LTD.

Room 2211, Bank of China Tower,
200 Yin Cheng Zhong Road,
PuDong New Area, Shanghai, 200120, China
Tel: (86) 21-5037-2222/Fax: (86) 21-5037-2200

Authorized Distributor:

© OMRON Corporation 2006-2020 All Rights Reserved.
In the interest of product improvement,
specifications are subject to change without notice.

CSM_3_3
Cat. No. J160-E1-05

0520(0306)

X-ON Electronics

Largest Supplier of Electrical and Electronic Components

Click to view similar products for [General Purpose Relays](#) category:

Click to view products by [Omron](#) manufacturer:

Other Similar products are found below :

[PCN-105D3MH,000](#) [59641F200](#) [5JO-1000CD-SIL](#) [5X827E](#) [5X837F](#) [5X840F](#) [5X842F](#) [5X848E](#) [LY2N-AC120](#) [LY2-US-AC120](#) [LY2-US-DC24](#) [LY3-US-AC120](#) [LY4F-UA-DC12](#) [LY4F-UA-DC24](#) [LY4F-US-AC120](#) [LY4F-US-AC240](#) [LY4F-US-DC24](#) [LY4F-VD-AC110](#)
[M115C60](#) [M115N010](#) [M115N0150](#) [603-12D](#) [60HE1-5DC](#) [60HE2S-12DC](#) [61211T0B4](#) [61212T400](#) [61222Q400](#) [61243B600](#) [61243C500](#)
[61243Q400](#) [61311BOA2](#) [61311BOA6](#) [61311BOA8](#) [61311C0A2](#) [61311COA1](#) [61311COA6](#) [61311F0A2](#) [61311QOA1](#) [61311QOA4](#)
[61311T0D6](#) [61311TOA6](#) [61311TOA7](#) [61311TOB3](#) [61311TOB4](#) [61311U0A6](#) [61312Q600](#) [61312T400](#) [61312T600](#) [61313U200](#) [61313U400](#)