

Safety Relay Unit

G9SA

CSM_G9SA_DS_E_10_2

The G9SA Series Offers a Complete Line-up of Compact Units.



- Four kinds of 45-mm wide Units are available:
A 3-pole model, a 5-pole model, and models with 3 poles and 2 OFF-delay poles, as well as a Two-hand Controller. Also available are 17.5-mm wide Expansion Units with 3 poles and 3 OFF-delay poles.
- Simple expansion connection.
- OFF-delay models have 15-step OFF-delay settings.
- Conforms to EN ISO13849-1 (PLe/Safety Category 4).
- Both DIN track mounting and screw mounting are possible.

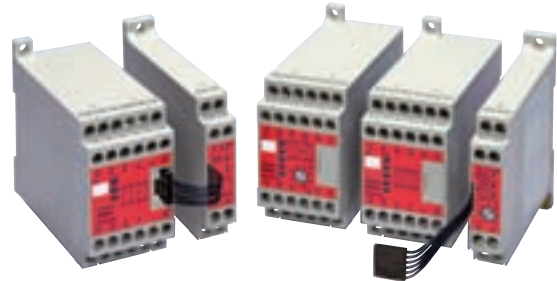

For the most recent information on models that have been certified for safety standards, refer to your OMRON website.

 Be sure to read the "Safety Precautions" on page 16

Model Number Structure

Model Number Legend

G9SA--

1 2 3 4 5 6

Note: 1. Please see "Ordering Information" on page 2 for the actual models that can be ordered.
2. Specify the power supply voltage when ordering.

1. Function

None: Emergency stop
EX: Expansion Unit
TH: Two-hand Controller

2. Contact Configuration (Safety Output)

0: None
3: 3PST-NO
5: 5PST-NO

3. Contact Configuration (OFF-delay Output)

0: None
2: DPST-NO
3: 3PST-NO

4. Contact Configuration (Auxiliary Output)

0: None
1: SPST-NC

5. Input Configuration

None: 1-channel or 2-channel input possible

6. OFF-delay Time (Max. setting time)

None: No OFF-delay
T075: 7.5 seconds
T15: 15 seconds
T30: 30 seconds

Ordering Information

Specify the power supply voltage when ordering.

Emergency-stop Units

| Main contacts | Auxiliary contact | Number of input channels | Rated voltage | Model |
|----------------|-------------------|----------------------------------|----------------|----------|
| 3PST-NO | SPST-NC | 1 channel or 2 channels possible | 24 VAC/VDC | G9SA-301 |
| 5PST-NO | | | 100 to 240 VAC | |
| | | | 24 VAC/VDC | G9SA-501 |
| 100 to 240 VAC | | | | |

Emergency-stop OFF-delay Units

| Main contacts | OFF-delay contacts | Auxiliary contact | Number of input channels | OFF-delay time | Rated voltage | Model |
|---------------|--------------------|-------------------|----------------------------------|----------------|----------------|---------------|
| 3PST-NO | DPST-NO | SPST-NC | 1 channel or 2 channels possible | 7.5 s | 24 VAC/VDC | G9SA-321-T075 |
| | | | | | 100 to 240 VAC | |
| | | | | 15 s | 24 VAC/VDC | G9SA-321-T15 |
| | | | | | 100 to 240 VAC | |
| | | | | 30 s | 24 VAC/VDC | G9SA-321-T30 |
| | | | | | 100 to 240 VAC | |

Note: Set to maximum values in the factory.

* The following 15-step OFF-delay time settings are available:

T075: 0.5, 1, 1.5, 2, 2.5, 3, 3.5, 4, 4.5, 5, 5.5, 6, 6.5, 7, and 7.5 s

T15: 1, 2, 3, 4, 5, 6, 7, 8, 9, 10, 11, 12, 13, 14, and 15 s

T30: 2, 4, 6, 8, 10, 12, 14, 16, 18, 20, 22, 24, 26, 28, and 30 s

Two-hand Controller

| Main contacts | Auxiliary contact | Number of input channels | Rated voltage | Model |
|---------------|-------------------|--------------------------|----------------|------------|
| 3PST-NO | SPST-NC | 2 channels | 24 VAC/VDC | G9SA-TH301 |
| | | | 100 to 240 VAC | |

Expansion Unit

The Expansion Unit connects to a G9SA-301, G9SA-501, G9SA-321, or G9SA-TH301.

| Main contacts | Auxiliary contact | Model |
|---------------|-------------------|------------|
| 3PST-NO | SPST-NC | G9SA-EX301 |

Expansion Units with OFF-delay Outputs

The Expansion Unit connects to a G9SA-301, G9SA-501 or G9SA-321.

| Main contact form | Auxiliary contact | OFF-delay time | Model |
|-------------------|-------------------|----------------|-----------------|
| 3PST-NO | SPST-NC | 7.5 s | G9SA-EX031-T075 |
| | | 15 s | G9SA-EX031-T15 |
| | | 30 s | G9SA-EX031-T30 |

Note: Set to maximum values in the factory.

* The following 15-step OFF-delay time settings are available:

T075: 0.5, 1, 1.5, 2, 2.5, 3, 3.5, 4, 4.5, 5, 5.5, 6, 6.5, 7, and 7.5 s

T15: 1, 2, 3, 4, 5, 6, 7, 8, 9, 10, 11, 12, 13, 14, and 15 s

T30: 2, 4, 6, 8, 10, 12, 14, 16, 18, 20, 22, 24, 26, 28, and 30 s

Specifications

Ratings

Power Input

| Item | Model | G9SA-301/TH301 | G9SA-501 | G9SA-321-T□ |
|-------------------------|-------|-------------------------------------------------------------------------------------|-------------------------------------------------------------|---------------------------------------------------------------|
| Power supply voltage | | 24 VAC/VDC: 24 VAC, 50/60 Hz, or 24 VDC 100 to 240 VAC: 100 to 240 VAC, 50/60 Hz | | |
| Operating voltage range | | 85% to 110% of rated power supply voltage | | |
| Power consumption * | | 24 VAC/VDC: 1.8 VA/1.7 W max. 100 to 240 VAC: 9 VA max. | 24 VAC/VDC: 2.8 VA/2.6 W max. 100 to 240 VAC: 11 VA max. | 24 VAC/VDC: 3.5 VA/3.3 W max. 100 to 240 VAC: 12.5 VA max. |

* When an Expansion Unit is connected, the power consumption is increased by 2 VA/2 W max.

Inputs

| Item | Model | G9SA-301/321-T□/TH301 | G9SA-501 |
|-----------------|-------|-----------------------|------------|
| Input current * | | 40 mA max. | 60 mA max. |

* When an Expansion Unit is connected, the input current is increased by 30 mA max.

Contacts

| Item | Model | G9SA-301/501/321-T□/TH301/EX301/EX031-T□ |
|---------------------|-------|------------------------------------------|
| Item | Load | Resistive load |
| Rated load | | 250 VAC, 5 A 30 VDC, 5 A |
| Rated carry current | | 5 A |

Characteristics

| Item | Model | G9SA-301/TH301 | G9SA-501/321-T□ | G9SA-EX301/EX031-T□ |
|------------------------------------------|----------------------------------------------------------------------|-------------------------------------------------------------------------|-----------------|---------------------|
| Contact resistance *1 | | 100 mΩ | | |
| Operating time *2 | | 30 ms max. | | |
| Response time *3 | | 10 ms max. | | |
| Insulation resistance *4 | | 100 MΩ min. (at 500 VDC) | | |
| Dielectric strength | Between different outputs | 2,500 VAC, 50/60 Hz for 1 min | | |
| | Between inputs and outputs | | | |
| | Between power inputs and outputs | | | |
| | Between power inputs and other inputs (only for 100 to 240-V models) | | | |
| Vibration resistance | | 10 to 55 to 10 Hz, 0.375-mm single amplitude (0.75-mm double amplitude) | | |
| Shock resistance | Destruction | 300 m/s ² | | |
| | Malfunction | 100 m/s ² | | |
| Durability *5 | Mechanical | 5,000,000 operations min. (at approx. 7,200 operations/hr) | | |
| | Electrical | 100,000 operations min. (at approx. 1,800 operations/hr) | | |
| Failure rate (P Level) (reference value) | | 5 VDC, 1 mA | | |
| Ambient operating temperature | | -25 to 55°C (with no icing or condensation) | | |
| Ambient operating humidity | | 35% to 85% | | |
| Terminal tightening torque | | 0.98 N·m | | |
| Weight *6 | | Approx. 210 g | Approx. 270 g | Approx. 130 g |

*1. The contact resistance was measured with 1 A at 5 VDC using the voltage-drop method.

*2. Not including bounce time.

*3. The response time is the time it takes for the main contact to open after the input is turned OFF. Includes bounce time.

*4. The insulation resistance was measured with 500 VDC at the same places that the dielectric strength was checked.

*5. The durability is for an ambient temperature of 15 to 35°C and an ambient humidity of 25% to 75%.

*6. Weight shown is for 24-VAC/VDC type. For 100 to 240-VAC type, add approximately 20 g.

Connections

Internal Connections

G9SA-301 (24 VAC/VDC)

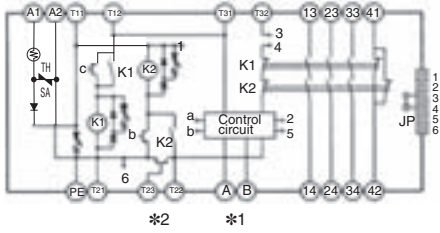

G9SA-301 (100 to 240 VAC)

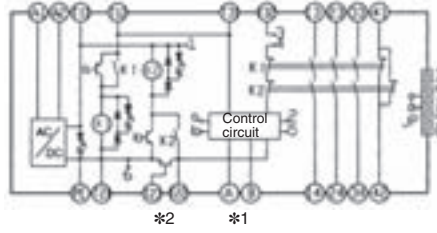

G9SA-501 (24 VAC/VDC)

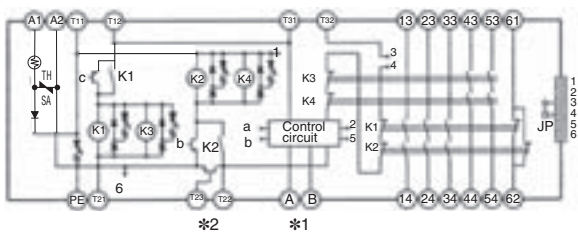

G9SA-501 (100 to 240 VAC)

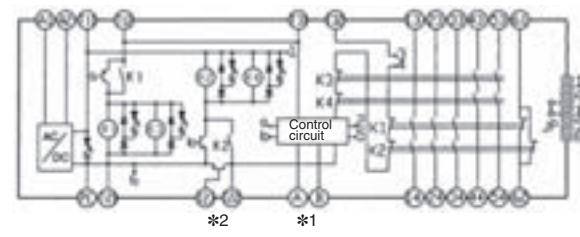

G9SA-321-T□ (24 VAC/VDC)

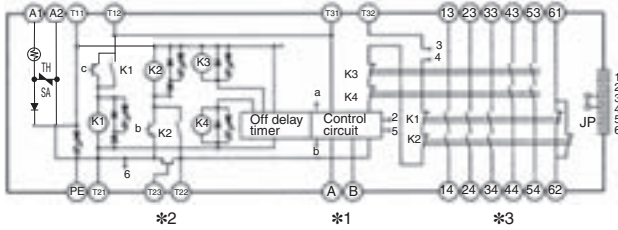

G9SA-321-T□ (100 to 240 VAC)

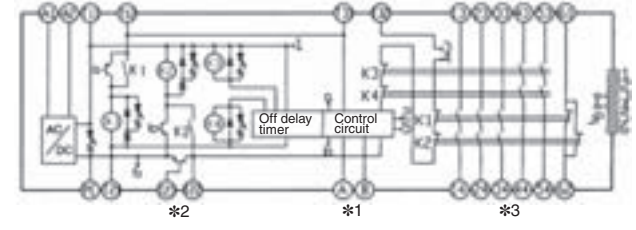

G9SA-TH301 (24 VAC/VDC)

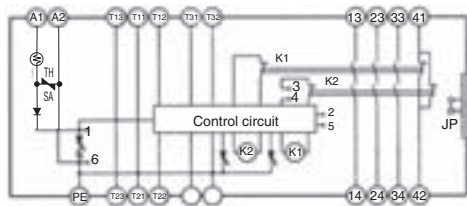

G9SA-TH301 (100 to 240 VAC)

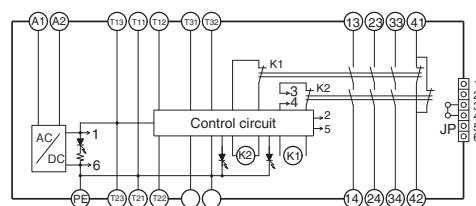

G9SA-EX301

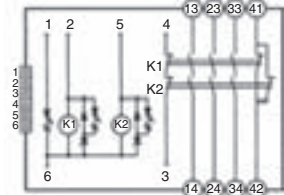

G9SA-EX031-T□

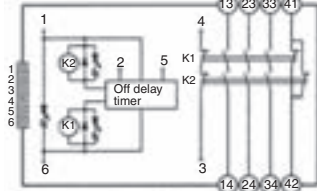

Note: 1. With 100 to 240-VAC type, be sure to connect PE to a protective ground. With 24-VAC/VDC type, if the power supply is not connected to a protective ground, be sure to connect PE to a protective ground.

2. With 24-VAC/VDC type, the power supply terminals A1 and A2 have polarities. A2 is the negative pole.

*1. Use terminals A and B to switch reset mode.

A to B open: Manual reset

A to B closed: Auto-reset

*2. Terminal T23 is used for 2-channel input with a positive common (when connecting a safety sensor with a PNP output).

When using T23, make sure that T21 and T22 are open.

For 1-channel input, make sure that T12 and T23 are shorted.

*3. Terminals 43-44 and terminals 53-54 are OFF-delayed outputs.

Wiring of Inputs and Outputs

| Signal name | Terminal name | Description of operation |
|------------------------------|------------------|---------------------------------------------------------------------------------------------------------------------------------------------------------------------------------------------------|
| Power supply input | A1, A2 | The input terminals for power supply. Connect the power source to the A1 and A2 terminals. DC inputs have polarity, so A1 should be connected to the positive side and A2 to the negative side. |
| Safety input 1 | T11, T12 | To set the safety outputs in the ON state, the ON state signals must be input to both safety input 1 and safety input 2. Otherwise the safety outputs cannot be in the ON state. |
| Safety input 2 | T21, T22, T23 *1 | |
| Feedback/reset input | T31, T32 | To set the safety outputs in the ON state, the ON state signal must be input to T31 - T32. Otherwise the safety outputs cannot be in the ON state. |
| Instantaneous safety outputs | See below. *2 | Turns ON/OFF according to the state of the safety inputs and feedback/reset inputs. During OFF-delay state, the Instantaneous safety outputs are not able to turn ON. |
| OFF-delayed safety outputs | See below. *2 | OFF-delayed safety outputs. The OFF-delay time is set by the OFF-delay preset switch. |
| Auxiliary output | See below. *2 | Synchronized with Instantaneous Safety Output. |
| Manual/Auto selector input | A, B *3 | Switch between Auto Reset and Manual Reset modes. |
| Ground terminal | PE | Be sure to connect the PE terminal to a protective earth for 100-240 VAC models. Where the 24 VAC/VDC model power supply is not grounded, please be sure to connect the PE to a protective earth. |

*1. Terminal T23

Terminal T23 is used for 2-channel input with a positive common (when connecting a safety sensor with a PNP output). When T23 is being used, please open T21 and T22. For 1-channel input, short circuit T12-T23 before use.

*2. Output Contacts

G9SA-301: Safety Output Contacts 13-14, 23-24, 33-34. Auxiliary Contact 41-42.

G9SA-501: Safety Output Contacts 13-14, 23-24, 33-34, 43-44, 53-54. Auxiliary Contact 61-62.

G9SA-321-□: Safety Output Contacts 13-14, 23-24, 33-34. Safety OFF-delay Output Contact 43-44, 53-54. Auxiliary Contact 61-62.

*3. Terminals A and B

A-B Opening: Manual Reset

A-B Short Circuit: Auto Reset

Dimensions and Terminal Arrangement

G9SA-301
 G9SA-501
 G9SA-321-T□
 G9SA-TH301

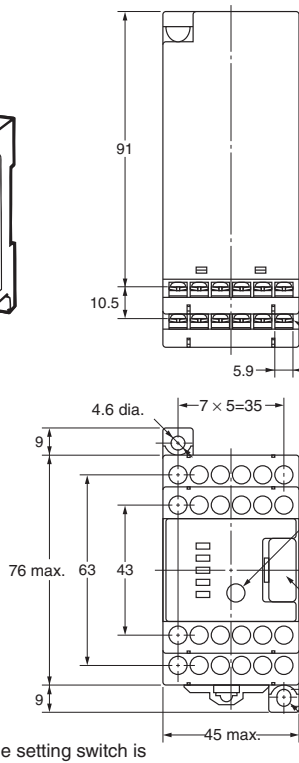
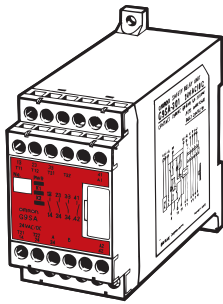

G9SA-301: Twenty, M3
 G9SA-501: Twenty-four, M3
 G9SA-321-T□: Twenty-four, M3
 G9SA-TH301: Twenty-one, M3

Terminal Arrangement

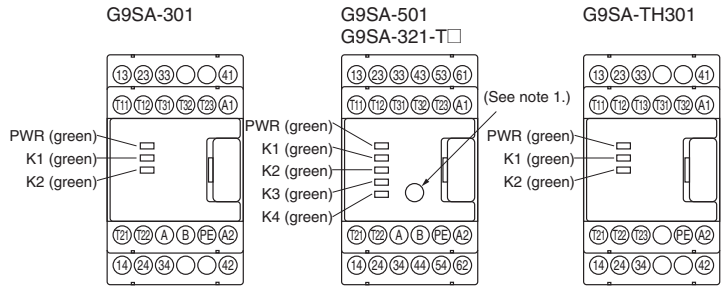

Mounting Holes



- Note 1:** The OFF-delay time setting switch is found on the G9SA-321-T□ only.
Note 2: The K1 to K4 indicators light when the NO contacts of internal relays K1 to K4 close.
 * Do not remove unless an Expansion Unit is being used.

G9SA-EX301
 G9SA-EX031-T□

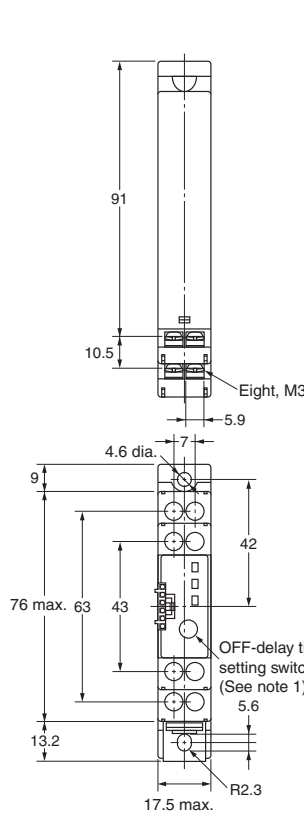
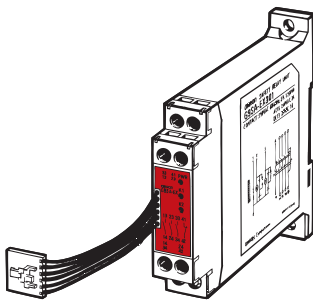

Mounting Holes

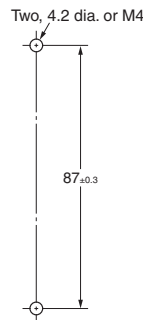

Terminal Arrangement

G9SA-EX301
 G9SA-EX031-T□

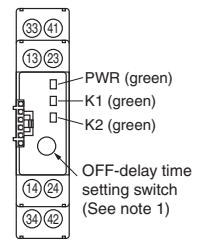

- Note 1:** The OFF-delay time setting switch is found on the G9SA-EX031-T□ only.
Note 2: The K1 and K2 indicators light when the NO contacts of internal relays K1 and K2 close.

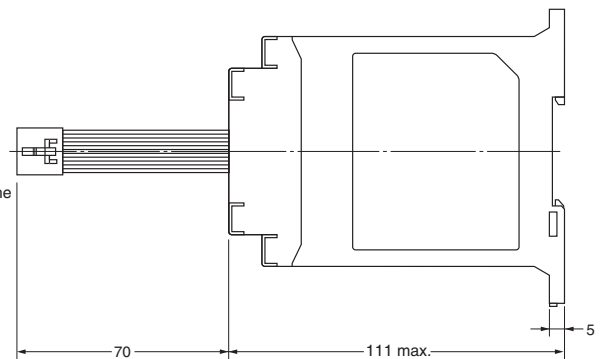

Application Examples

G9SA-301 (24 VAC/VDC) with 2-channel Limit Switch Input/Auto-reset

| PL/safety category | Model | Stop category | Reset |
|--------------------|----------------------------------------------------------------------------|---------------|-------|
| PLe/4 equivalent | Safety Limit Switch D4B-N/D4N/D4F Safety Relay Unit G9SA-301 24 VAC/VDC | 0 | Auto |

Note: The above PL is only the evaluation result of the example. The PL must be evaluated in an actual application by the customer after confirming the usage conditions.

●Application Overview

- The power supply to the motor M is turned OFF when the S1 and S2 detect that the guard is opened.
- The power supply to the motor M is kept OFF until the guard is closed.

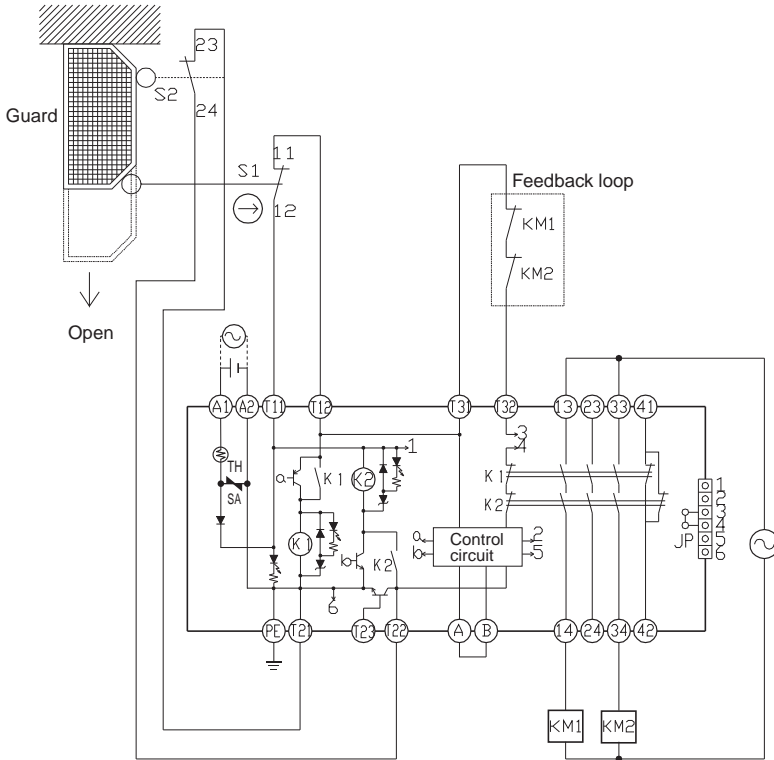

Timing Chart

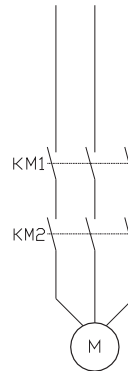
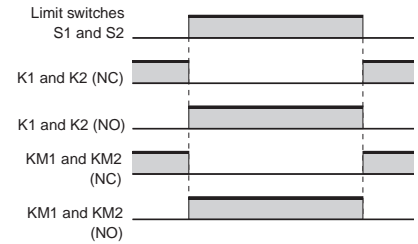

- S1: Safety Limit Switch with direct opening mechanism (NC) ⊕
- S2: Limit switch (NO)
- KM1 and KM2: Magnetic Contactor
- M: 3-phase motor

G9SA-301 (24 VAC/VDC) with 2-channel Limit Switch Input/Manual Reset

| PL/safety category | Model | Stop category | Reset |
|--------------------|----------------------------------------------------------------------------|---------------|--------|
| PLe/4 equivalent | Safety Limit Switch D4B-N/D4N/D4F Safety Relay Unit G9SA-301 24 VAC/VDC | 0 | Manual |

Note: The above PL is only the evaluation result of the example. The PL must be evaluated in an actual application by the customer after confirming the usage conditions.

Application Overview

- The power supply to the motor M is turned OFF when the S1 and S2 detect that the guard is opened.
- The power supply to the motor M is kept OFF until the guard is closed and the reset switch S3 is pressed.

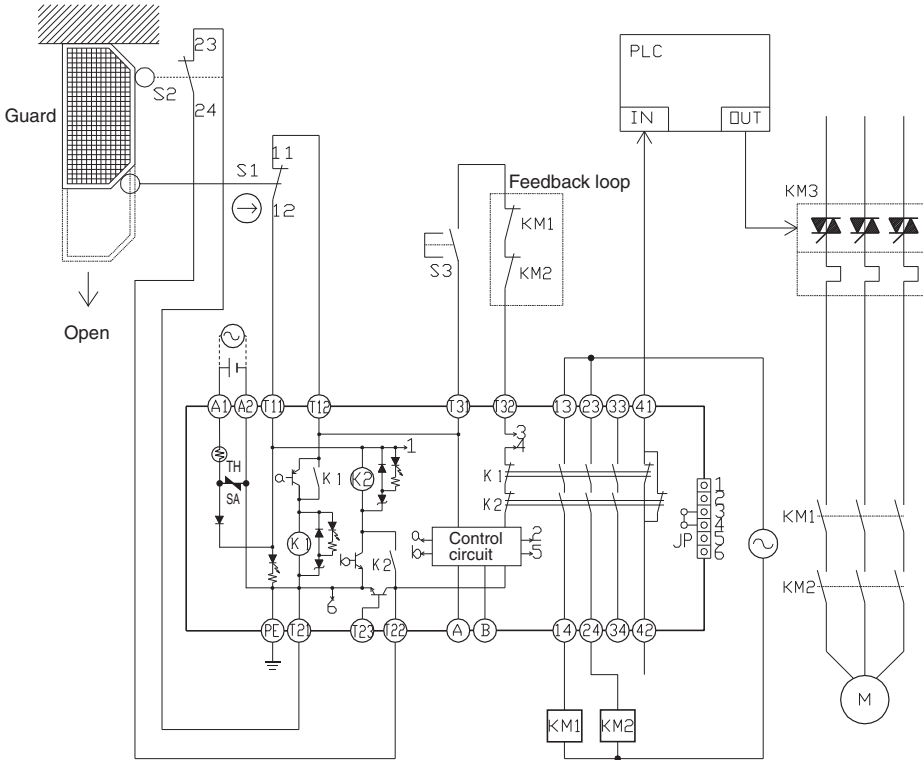

Timing Chart

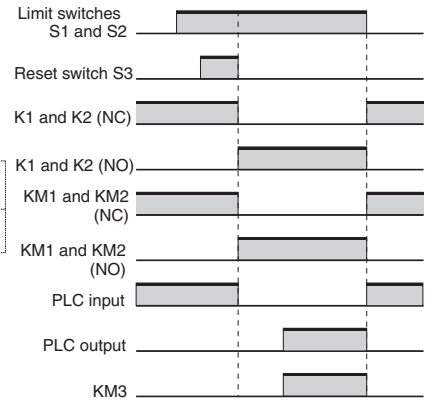

- S1: Safety Limit Switch with direct opening mechanism (NC) ⊕
- S2: Limit switch (NO)
- S3: Reset switch
- KM1 and KM2: Magnetic Contactor
- KM3: G3J Solid-state Contactor (G3J)
- M: 3-phase motor

G9SA-301 (100 to 240 VAC) with 2-channel Limit Switch Input/Auto-reset

| PL/safety category | Model | Stop category | Reset |
|--------------------|--------------------------------------------------------------------------------|---------------|-------|
| PLe/4 equivalent | Safety Limit Switch D4B-N/D4N/D4F Safety Relay Unit G9SA-301 100 to 240 VAC | 0 | Auto |

Note: The above PL is only the evaluation result of the example. The PL must be evaluated in an actual application by the customer after confirming the usage conditions.

Application Overview

- The power supply to the motor M is turned OFF when the S1 and S2 detect that the guard is opened.
- The power supply to the motor M is kept OFF until the guard is closed.

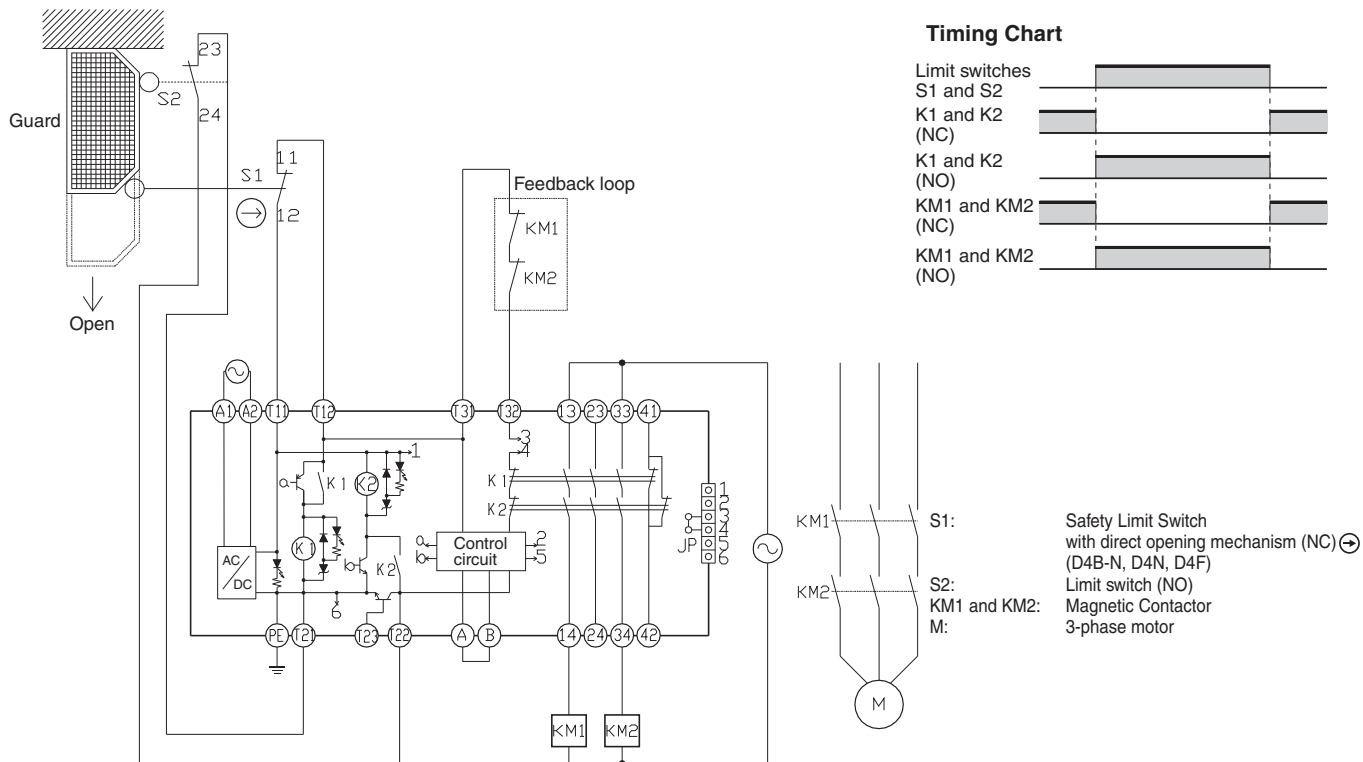

G9SA-301 (24 VAC/VDC) with 2-channel Emergency Stop Switch Input/Manual Reset

| PL/safety category | Model | Stop category | Reset |
|--------------------|---------------------------------------------------------------------------|---------------|--------|
| PLe/4 equivalent | Emergency Stop Switch A165E/A22E Safety Relay Unit G9SA-301 24 VAC/VDC | 0 | Manual |

Note: The above PL is only the evaluation result of the example. The PL must be evaluated in an actual application by the customer after confirming the usage conditions.

●Application Overview

- The power supply to the motor M is turned OFF when the emergency stop switch is pressed.
- The power supply to the motor M is kept OFF until the reset switch S2 is pressed while the emergency stop switch is released.

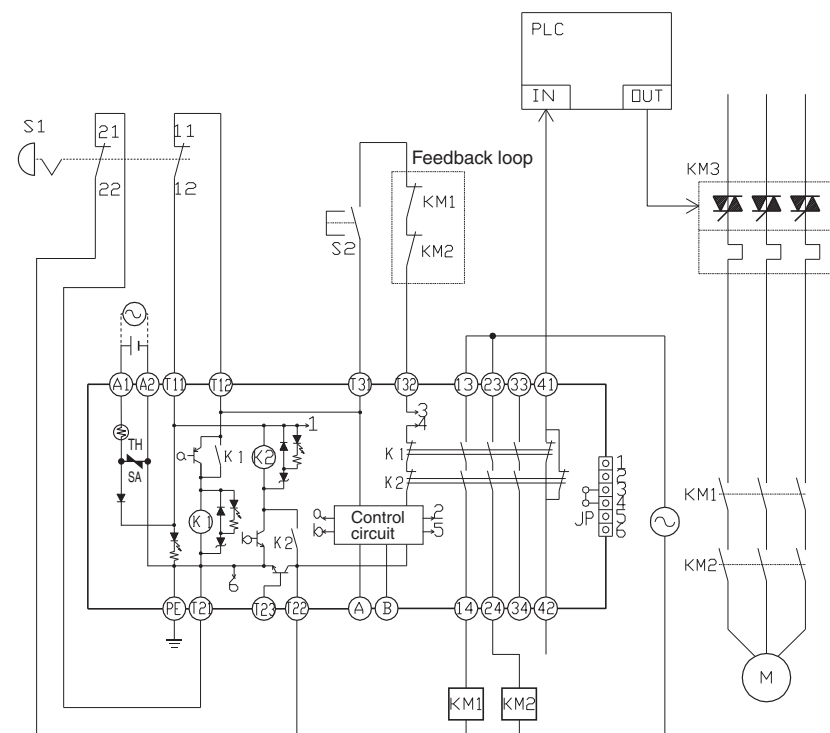

Timing Chart

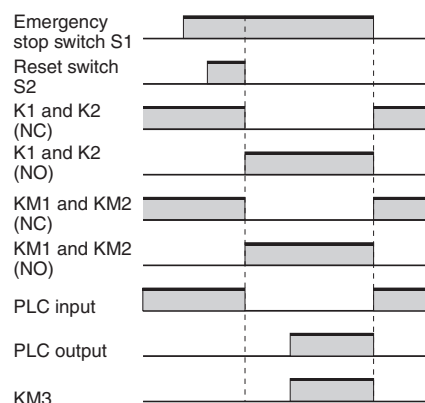

- S1: Emergency stop switch with direct opening mechanism (A165E or A22E)
- S2: Reset switch
- KM1 and KM2: Magnetic Contactor
- KM3: G3J Solid-state Contactor (G3J)
- M: 3-phase motor

G9SA-321-T□ (24 VAC/VDC) with 2-channel Limit Switch Input/Manual Reset

| PL/safety category | Model | Stop category | Reset |
|--------------------|-------------------------------------------------------------------------------|---------------|--------|
| PLd/3 equivalent | Safety Limit Switch D4B-N/D4N/D4F Safety Relay Unit G9SA-321-T□ 24 VAC/VDC | 1 | Manual |

Note: The above PL is only the evaluation result of the example. The PL must be evaluated in an actual application by the customer after confirming the usage conditions.

●Application Overview

- Stop signal is sent to the motor controller to decelerate the motor M when the S1 and S2 detect that the guard is opened.
- The power supply to the motor M is turned OFF after OFF-delay time.
- The power supply to the motor M is kept OFF until the guard is closed and the reset switch S3 is pressed.

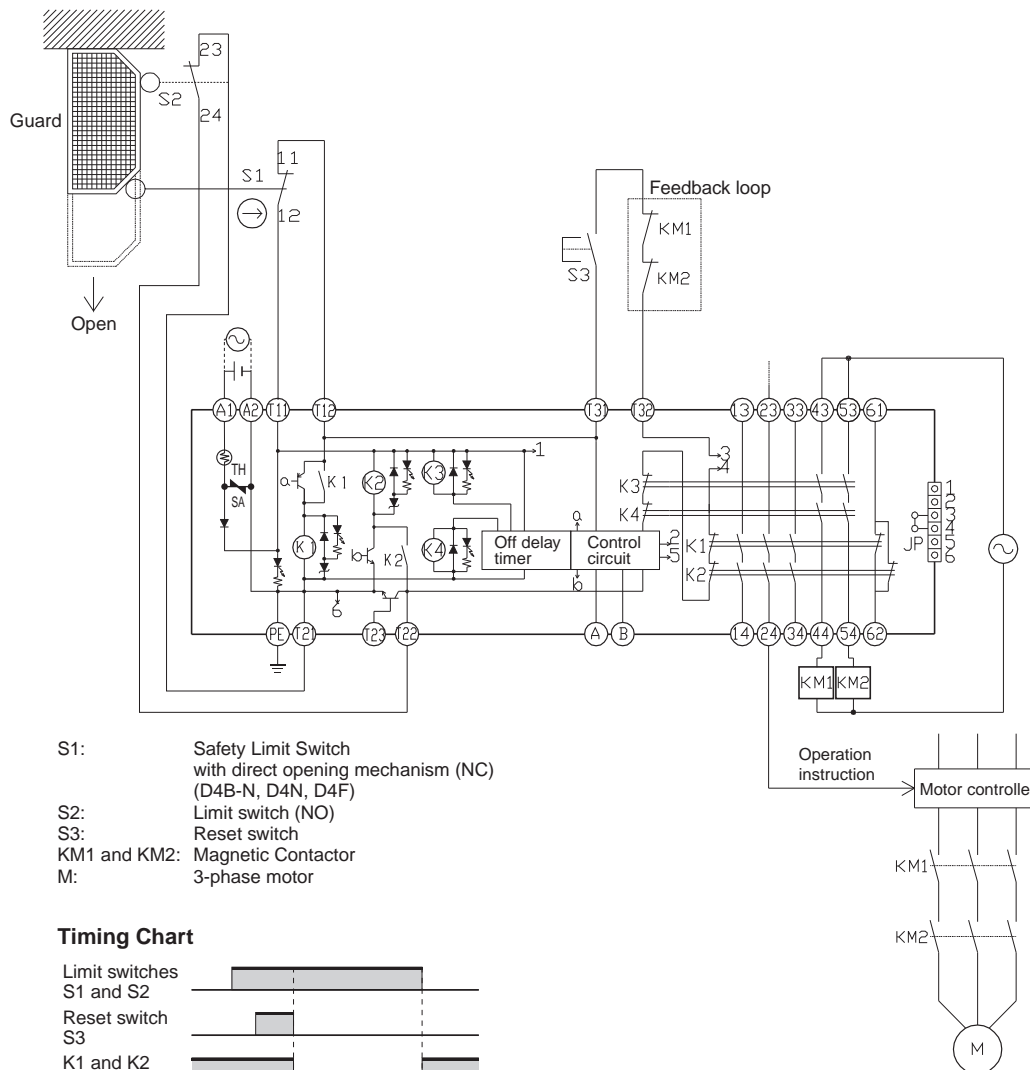

- S1: Safety Limit Switch with direct opening mechanism (NC) (D4B-N, D4N, D4F)
 S2: Limit switch (NO)
 S3: Reset switch
 KM1 and KM2: Magnetic Contactor
 M: 3-phase motor

Timing Chart

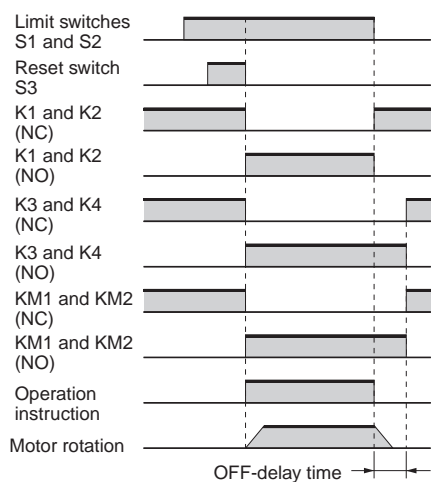

G9SA-321-T□ (24 VAC/VDC) + G9SA-EX031-T□ with 2-channel Limit Switch Input/Manual Reset

| PL/safety category | Model | Stop category | Reset |
|--------------------|-----------------------------------------------------------------------------------------------|---------------|--------|
| PLd/3 equivalent | Safety Limit Switch D4B-N/D4N/D4F Safety Relay Unit G9SA-321-T□ 24 VAC/VDC + G9SA-EX031-T□ | 1 | Manual |

Note: The above PL is only the evaluation result of the example. The PL must be evaluated in an actual application by the customer after confirming the usage conditions.

●Application Overview

- Stop signal is sent to the motor controller to decelerate the motor M1 and M2 when the S1 and S2 detect that the guard is opened.
- The power supply to the motor M1 and M2 is turned OFF after OFF-delay time.
- The power supply to the motor M1 and M2 is kept OFF until the guard is closed and the reset switch S3 is pressed.

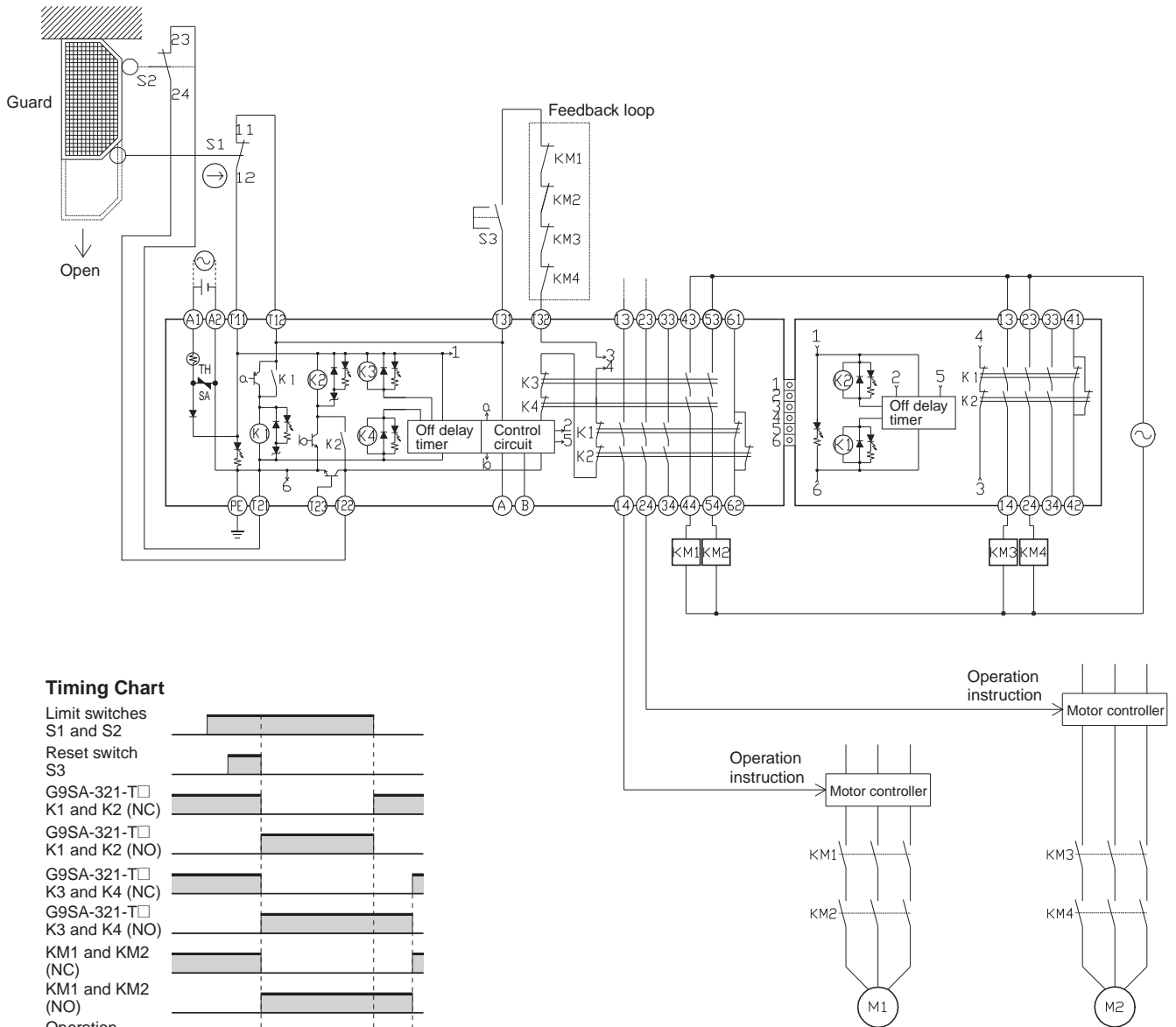

Timing Chart

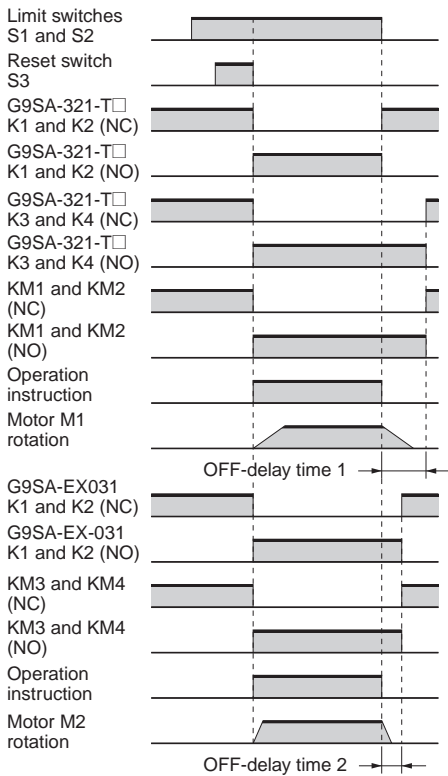

- S1: Safety Limit Switch with direct opening mechanism (NC) (D4B-N, D4N, D4F)
- S2: Limit switch (NO)
- S3: Reset switch
- KM1, KM2, KM3, and KM4: Magnetic Contactor
- M1, M2: 3-phase motor

G9SA-301 (24 VAC/VDC) with 2-channel Safety Sensor/Manual Reset (PNP models only)

| PL/safety category | Model | Stop category | Reset |
|--------------------|------------------------------------------------------------------------------|---------------|--------|
| PLe/4 equivalent | Safety Light Curtain F3SJ-A□□□□P□□□ Safety Relay Unit G9SA-301 24 VAC/VDC | 0 | Manual |

Note: The above PL is only the evaluation result of the example. The PL must be evaluated in an actual application by the customer after confirming the usage conditions.

●Application Overview

- The power supply to the motor M is turned OFF when the beam is blocked.
- The power supply to the motor M is kept OFF until the beam is unblocked and the reset switch S1 is pressed.

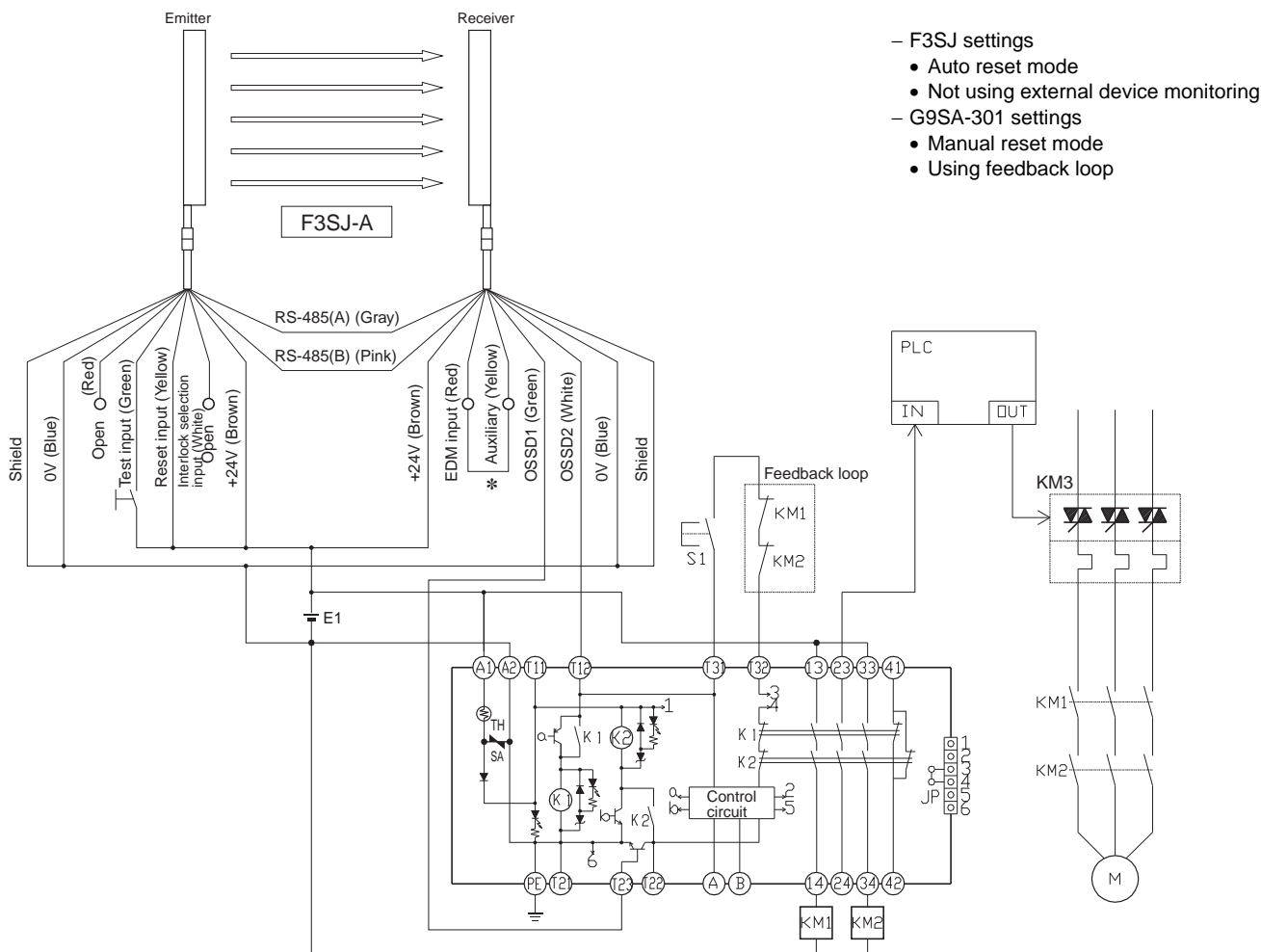

- F3SJ settings
 - Auto reset mode
 - Not using external device monitoring
- G9SA-301 settings
 - Manual reset mode
 - Using feedback loop

* The F3SJ-A auxiliary output wiring is shown for dark-ON operation.

Timing Chart

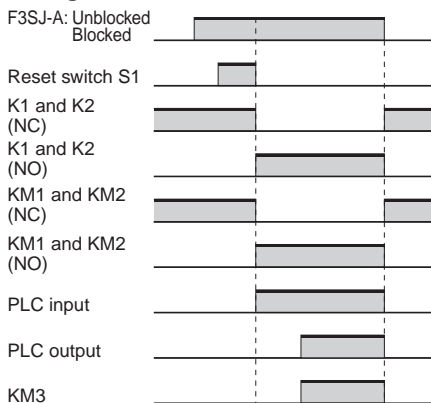

- F3SJ-A: Safety sensor
- S1: Reset switch
- KM1 and KM2: Magnetic Contactor
- KM3: G3J Solid-state Contactor (G3J)
- M: 3-phase motor
- E1: 24-VDC Power Supply (S82K)

G9SA-TH301 (24 VAC/VDC) with 2-hand Inputs

| PL/safety category | Model | Stop category | Reset |
|--------------------|-----------------------------------------|---------------|-------|
| PLe/4 equivalent | Safety Relay Unit G9SA-TH301 24 VAC/VDC | 0 | - |

Note: The above PL is only the evaluation result of the example. The PL must be evaluated in an actual application by the customer after confirming the usage conditions.

●Application Overview

- The motor M is turned ON when the two-hand pushbutton switch S11 and S12 are pressed simultaneously.
- The motor M is turned OFF when one of the two-hand pushbutton switches is released.

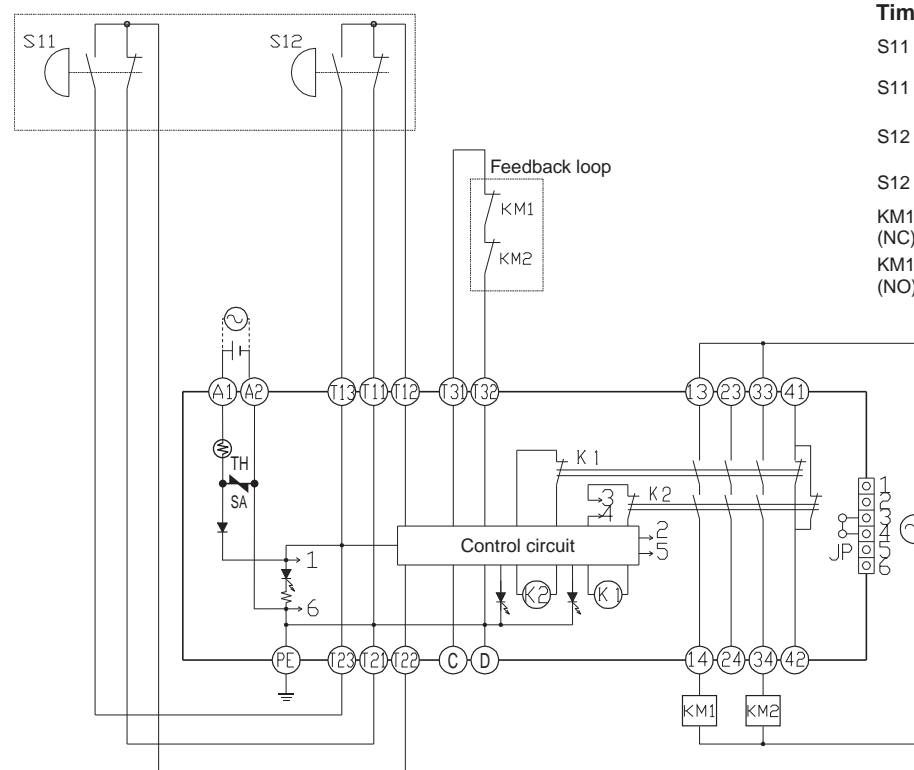

Timing Chart

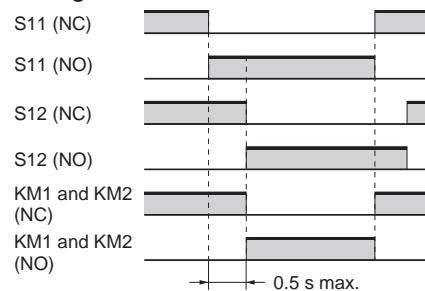

Input time difference operates only when the difference is 0.5 s max.

S11, S12: Two-hand pushbutton switches
KM1 and KM2: Magnetic Contactor

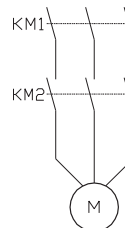

Note: Use a 1NC+1NO switch for S11 and S12.

G9SA-501 (24 VAC/VDC) and G9SA-EX301 with 2-channel Limit Switch Input/Manual Reset

| PL/safety category | Model | Stop category | Reset |
|--------------------|-----------------------------------------------------------------------------------------|---------------|--------|
| PLe/4 equivalent | Safety Limit Switch D4B-N/D4N/D4F Safety Relay Unit G9SA-501 24 VAC/VDC + G9SA-EX301 | 0 | Manual |

Note: The above PL is only the evaluation result of the example. The PL must be evaluated in an actual application by the customer after confirming the usage conditions.

●Application Overview

- The power supply to the motor M is turned OFF when the S1 and S2 detect that the guard is opened.
- The power supply to the motor M is kept OFF until the guard is closed and the reset switch S3 is pressed.

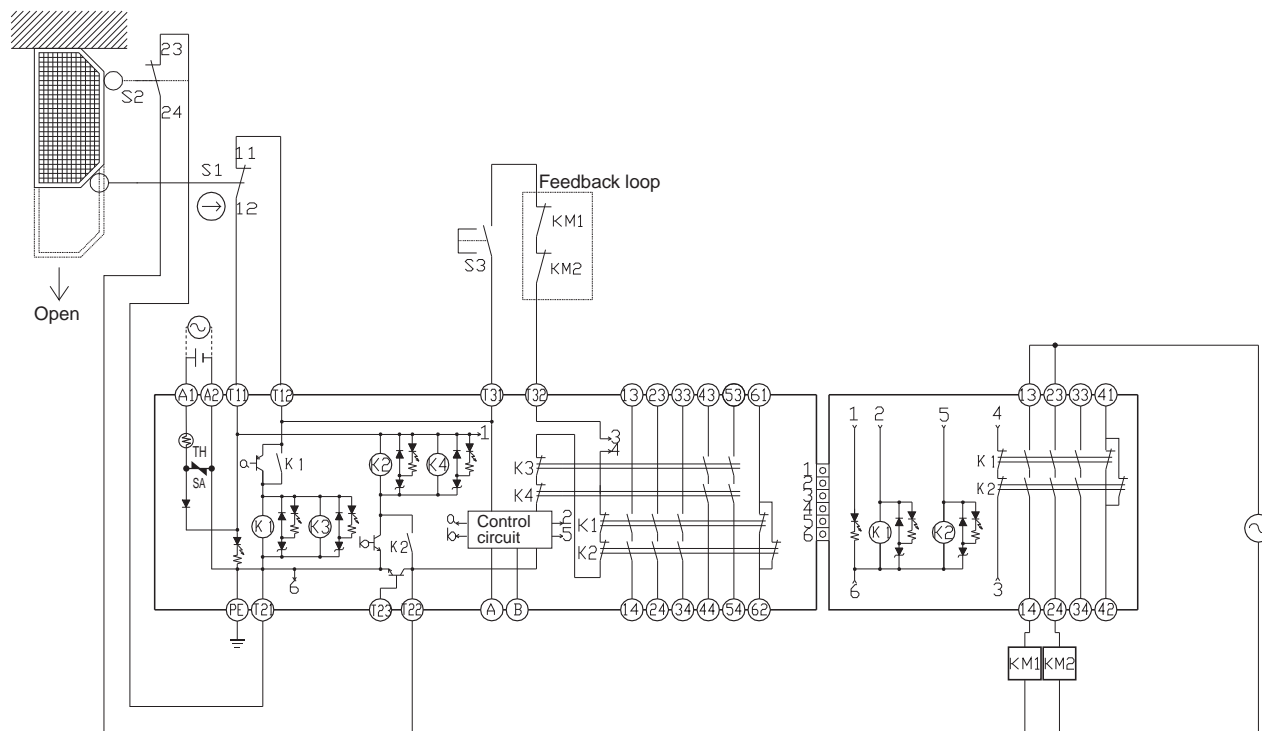

- S1: Safety Limit Switch with direct opening mechanism (NC) (D4B-N, D4N, D4F)
- S2: Limit switch (NO)
- S3: Reset switch
- KM1 and KM2: Magnetic Contactor
- M: 3-phase motor

Timing Chart

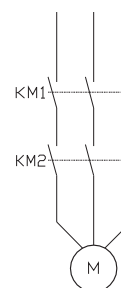
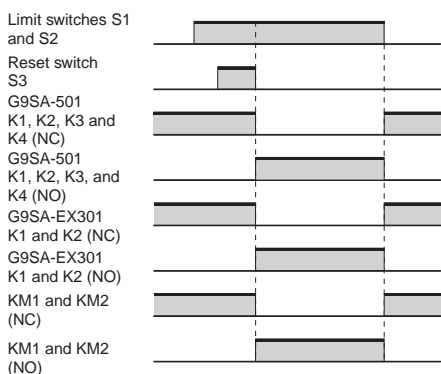

Safety Precautions

Be sure to read the precautions “*Precautions for All Relays*” and “*Precautions for All Relays with Forcibly Guided Contacts*” in the website at: <http://www.ia.omron.com/>.

CAUTION

Turn OFF the G9SA before wiring the G9SA. Do not touch the terminals of the G9SA while the power is turned ON, because the terminals are charged and may cause an electric shock.



Precautions for Correct Use

Failure Detection for Slow-starting Power Supply

When using a power supply with a long start-up time, if power is switched on while input has been closed the internal circuits will detect a power voltage error and the product will not operate. Apply the voltage to the product once the voltage has reached its rated level.

Installation

The G9SA can be installed in any direction.

Wiring

- Use the following to wire the G9SA.
 - Stranded wire: 0.75 to 1.5 mm²
 - Solid wire: 1.0 to 1.5 mm²
- Tighten each screw to a torque of 0.78 to 1.18 N·m, or the G9SA may malfunction or generate heat.
- External inputs connected to T11 and T12 or T21 and T22 must be no-voltage contact inputs.
- PE is a ground terminal.
 - When a machine is grounded at the positive, the PE terminal should not be grounded.

Connector Cover

Do not remove the connector cover of the G9SA-301, G9SA-501, G9SA-321-T□, or G9SA-TH301 unless an Expansion Unit is being used.

Mounting Expansion Units

- Turn OFF the G9SA before connecting the Expansion Unit.
- When an Expansion Unit is being used, remove the connector cover from the G9SA Safety Relay Unit (G9SA-301, G9SA-501, G9SA-321-T□, or G9SA-TH301) and insert the connector of the Expansion Unit's connector cable.

Mounting Multiple Units

When mounting multiple Units close to each other, the rated current will be 3 A. Do not apply a current higher than 3 A.

Applicable Performance Level (PL) (EN ISO13849-1)

G9SA-series Relays meet the requirements of PL_e/Safety Category 4 of the EN ISO13849-1 standards when they are used as shown in the examples provided by OMRON. The Relays may not meet the standards in some operating conditions. The OFF-delay output of models G9SA-321-T□ and EX031-T□, however, conform to PL_d/Safety Category 3.

The applicable performance level is determined from the whole safety control system. Make sure that the whole safety control system meets EN ISO13849-1 requirements.

Connecting Inputs

If using multiple G9SA models, inputs cannot be made using the same switch. This is also true for other input terminals.

Incorrect

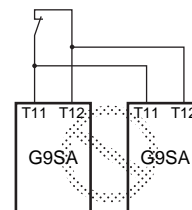

Ground Shorts

The G9SA internal circuits have a positive thermistor (TH) built in, which will detect ground short malfunctions (where S1 and S2 are grounded) and 1-channel and 2-channel short malfunctions, and cut off the safety output. If the short breakdown is repaired, the G9SA automatically recovers.

Resetting Inputs

When only channel 1 of the 2-channel input turns OFF, the safety output is interrupted. In order to restart when this happens, it is necessary to turn OFF and ON both input channels. It is not possible to restart by resetting only channel 1.

Resetting Inputs During OFF Delay Time

The G9SA-321-T□ operates as follows according to the reset mode when the inputs are to be re-entered during the OFF delay time of the G9SA-321-T□:

For auto reset, after the OFF delay time has ended, the outputs will turn OFF, and then the outputs will turn ON again.
For manual reset, after the OFF delay time has ended, the outputs will turn OFF, and then the outputs will turn ON again when the reset is input.

Durability of Contact Outputs

Relay with Forcibly Guided Contact durability depends greatly on the switching condition. Confirm the actual conditions of operation in which the Relay will be used in order to make sure the permissible number of switching operations.

When the accumulated number of operation exceeds its permissible range, it can cause failure of reset of safety control circuit. In such case, please replace the Relay immediately. If the Relay is used continuously without replacing, then it can lead to loss of safety function.

Certified Standards

The G9SA-301/501/321-T□/TH301/EX301/EX031-T□ conform to the following standards.

- EN standards, certified by DGUV:
 - EN60947-5-1
 - EN ISO13849-1: 2008
 - EN ISO13849-2
 - GS-ET-20
 - EN574 (G9SA-TH301 only)
- UL standards: UL508 (Industrial Control Equipment)
- CSA standards: CSA C22.2 No. 14 (Industrial Control Equipment)
- CCC Certification: GB14048.5

Terms and Conditions Agreement

Read and understand this catalog.

Please read and understand this catalog before purchasing the products. Please consult your OMRON representative if you have any questions or comments.

Warranties.

(a) Exclusive Warranty. Omron's exclusive warranty is that the Products will be free from defects in materials and workmanship for a period of twelve months from the date of sale by Omron (or such other period expressed in writing by Omron). Omron disclaims all other warranties, express or implied.

(b) Limitations. OMRON MAKES NO WARRANTY OR REPRESENTATION, EXPRESS OR IMPLIED, ABOUT NON-INFRINGEMENT, MERCHANTABILITY OR FITNESS FOR A PARTICULAR PURPOSE OF THE PRODUCTS. BUYER ACKNOWLEDGES THAT IT ALONE HAS DETERMINED THAT THE PRODUCTS WILL SUITABLY MEET THE REQUIREMENTS OF THEIR INTENDED USE.

Omron further disclaims all warranties and responsibility of any type for claims or expenses based on infringement by the Products or otherwise of any intellectual property right. (c) Buyer Remedy. Omron's sole obligation hereunder shall be, at Omron's election, to (i) replace (in the form originally shipped with Buyer responsible for labor charges for removal or replacement thereof) the non-complying Product, (ii) repair the non-complying Product, or (iii) repay or credit Buyer an amount equal to the purchase price of the non-complying Product; provided that in no event shall Omron be responsible for warranty, repair, indemnity or any other claims or expenses regarding the Products unless Omron's analysis confirms that the Products were properly handled, stored, installed and maintained and not subject to contamination, abuse, misuse or inappropriate modification. Return of any Products by Buyer must be approved in writing by Omron before shipment. Omron Companies shall not be liable for the suitability or unsuitability or the results from the use of Products in combination with any electrical or electronic components, circuits, system assemblies or any other materials or substances or environments. Any advice, recommendations or information given orally or in writing, are not to be construed as an amendment or addition to the above warranty.

See <http://www.omron.com/global/> or contact your Omron representative for published information.

Limitation on Liability; Etc.

OMRON COMPANIES SHALL NOT BE LIABLE FOR SPECIAL, INDIRECT, INCIDENTAL, OR CONSEQUENTIAL DAMAGES, LOSS OF PROFITS OR PRODUCTION OR COMMERCIAL LOSS IN ANY WAY CONNECTED WITH THE PRODUCTS, WHETHER SUCH CLAIM IS BASED IN CONTRACT, WARRANTY, NEGLIGENCE OR STRICT LIABILITY.

Further, in no event shall liability of Omron Companies exceed the individual price of the Product on which liability is asserted.

Suitability of Use.

Omron Companies shall not be responsible for conformity with any standards, codes or regulations which apply to the combination of the Product in the Buyer's application or use of the Product. At Buyer's request, Omron will provide applicable third party certification documents identifying ratings and limitations of use which apply to the Product. This information by itself is not sufficient for a complete determination of the suitability of the Product in combination with the end product, machine, system, or other application or use. Buyer shall be solely responsible for determining appropriateness of the particular Product with respect to Buyer's application, product or system. Buyer shall take application responsibility in all cases.

NEVER USE THE PRODUCT FOR AN APPLICATION INVOLVING SERIOUS RISK TO LIFE OR PROPERTY OR IN LARGE QUANTITIES WITHOUT ENSURING THAT THE SYSTEM AS A WHOLE HAS BEEN DESIGNED TO ADDRESS THE RISKS, AND THAT THE OMRON PRODUCT(S) IS PROPERLY RATED AND INSTALLED FOR THE INTENDED USE WITHIN THE OVERALL EQUIPMENT OR SYSTEM.

Programmable Products.

Omron Companies shall not be responsible for the user's programming of a programmable Product, or any consequence thereof.

Performance Data.

Data presented in Omron Company websites, catalogs and other materials is provided as a guide for the user in determining suitability and does not constitute a warranty. It may represent the result of Omron's test conditions, and the user must correlate it to actual application requirements. Actual performance is subject to the Omron's Warranty and Limitations of Liability.

Change in Specifications.

Product specifications and accessories may be changed at any time based on improvements and other reasons. It is our practice to change part numbers when published ratings or features are changed, or when significant construction changes are made. However, some specifications of the Product may be changed without any notice. When in doubt, special part numbers may be assigned to fix or establish key specifications for your application. Please consult with your Omron's representative at any time to confirm actual specifications of purchased Product.

Errors and Omissions.

Information presented by Omron Companies has been checked and is believed to be accurate; however, no responsibility is assumed for clerical, typographical or proofreading errors or omissions.

2015.7

In the interest of product improvement, specifications are subject to change without notice.

OMRON Corporation
Industrial Automation Company

<http://www.ia.omron.com/>

(c)Copyright OMRON Corporation 2015 All Right Reserved.

X-ON Electronics

Largest Supplier of Electrical and Electronic Components

Click to view similar products for [Safety Relays](#) category:

Click to view products by [Omron](#) manufacturer:

Other Similar products are found below :

[7-1618103-5](#) [1351-1X](#) [1618082-4](#) [1618111-1](#) [C200HDA003](#) [C200HMR432](#) [C200HMR832](#) [C200HMR833](#) [C28PEDRA](#) [20-050-36X](#)
[C500ETL01](#) [C500OD415CN](#) [2-1618068-0](#) [9-1618103-2](#) [SP10-ETL01](#) [22-060X](#) [C200HNC112](#) [C200HOD214](#) [C500CN812N](#) [4NK0AQY](#)
[1100X](#) [1100-42X](#) [V23050A1012A551](#) [6-1618082-4](#) [7-1618103-6](#) [WTD-101X](#) [SP16DRD](#) [SP16DRA](#) [C500-CE243](#) [C500-IDS02-V1](#)
[607.5111.020](#) [DOLD 48173](#) [CS AR-22V230](#) [PSR-MS21-1NO-1DO-24DC-SC](#) [600PSR-165/300-CU](#) [J73KN-AM-22](#) [G7SA-4A2B DC12](#)
[SR6V6K18](#) [SR4M4005](#) [BPS 36-1](#) [BP34 - 101057553](#) [2TLA010033R3000](#) [2TLA010033R2000](#) [2TLA010033R0000](#) [2TLA010017R0100](#)
[SCR 2-W22-2.5](#) [7S.34.9.110.4220](#) [RLY3-TIME100](#) [XPSUDN33AP](#) [XPSUEP34AP](#)