

## Solid-state Timer

## H3RN

### Ultra-slim Timer for G2R Relay Socket

- Pin configuration compatible with G2R Relay and mounts to the P2R/P2RF Socket.
- Standard multiple time ranges and multiple operating modes.
- Conforms to VDE 0435/P2021 and approved by UL and CSA.
- Conforms to EMC standards.



### Ordering Information

Supply voltage	Time-limit contact	Short-time range model (0.1 s to 10 min)	Long-time range model (0.1 min to 10 h)
24 VAC; 12, 24 VDC	SPDT	H3RN-1	H3RN-11
	DPST-NO	H3RN-2	H3RN-21

**Note:** Specify both the model number and supply voltage when ordering.

Example: H3RN-1 24 VAC

Supply voltage

### Model Number Legend:

H3RN-j<sub>1</sub>j<sub>2</sub>

#### 1. Output

- 1: SPDT
- 2: DPST-NO

#### 2. Time Range

- None: Short-time range (0.1 s to 10 min)
- 1: Long-time range (0.1 min to 10 hrs)

### ■ Accessories (Order Separately)

#### Connecting Socket

Timer	Track mounting/Front connecting socket	Back connecting socket
H3RN-1/-11	P2RF-05-E	P2R-057P
H3RN-2/-21	P2RF-08-E	P2R-087P

# Specifications

## ■ Ratings

Item	H3RN-1/-2	H3RN-11/-21
Time ranges	0.1 s to 10 min (1 s, 10 s, 1 min, or 10 min max. selectable)	0.1 min to 10 h (1 min, 10 min, 1 h, or 10 hrs max. selectable)
Rated supply voltage	24 VAC; 12, 24 VDC	
Pin type	Plug-in	
Operating mode	ON-delay, interval, flicker OFF-start, or flicker-ON start selectable by DIP switch	
Operating voltage range	85% to 110% of rated supply voltage (12 VDC: 90% to 110% of rated supply voltage) (see note)	
Power consumption	24 VAC: Relay ON: approx. 0.8 VA (at 24 VAC, 60 Hz) Relay OFF: 0.5 VA (at 24 VAC, 60 Hz) 12 VDC: Relay ON: approx. 0.4 W (at 12 VDC) Relay OFF: 0.1 W (at 12 VDC) 24 VDC: Relay ON: approx. 0.5 W (at 24 VDC) Relay OFF: 0.2 W (at 24 VDC)	
Control outputs	3 A at 250 VAC, resistive load ( $\cos\phi = 1$ ) (G6B-2j 14P-FD-US used) The minimum applicable load is 10 mA at 5 VDC (P reference value).	

**Note:** When using the H3RN in any place where the ambient temperature is more than 50°C, supply 90% to 110% of the rated voltages (12 VDC: 95% to 110% of the rated voltage).

## ■ Characteristics

Item	H3RN-1/-2	H3RN-11/-21
Accuracy of operating time	±1% FS max. (1 s range: ±1%±10 ms max.)	
Setting error	±15%±50 ms FS max.	
Reset time	Min. power-opening time: 12, 24 VDC: 0.1 s max. (including halfway reset) 24 VAC: 0.5 s max. (including halfway reset)	
Influence of voltage	±2% FS max.	
Influence of temperature	±2% FS max.	
Insulation resistance	100 MΩ min. (at 500 VDC)	
Dielectric strength	2,000 VAC, 50/60 Hz for 1 min (between operating circuit and control output, or contacts of different poles) 1,000 VAC, 50/60 Hz for 1 min (between non-continuous contacts)	
Vibration resistance	Destruction: 10 to 55 Hz, 0.75-mm single amplitude Malfunction: 10 to 55 Hz, 0.5-mm single amplitude	
Shock resistance	Destruction: 300 m/s <sup>2</sup> (approx. 30G) Malfunction: 100 m/s <sup>2</sup> (approx. 10G)	
Ambient temperature	Operating: -10°C to 55°C (with no icing) Storage: -25°C to 65°C (with no icing)	
Ambient humidity	Operating: 35% to 85%	
Life expectancy	Mechanical: 10,000,000 operations min. (under no load at 1,800 operations/h) Electrical: 100,000 operations min. (3 A at 250 VAC, resistive load at 1,800 operations/h)	
Impulse withstand voltage	Between power terminals: 1 kV	
Noise immunity	±1.5 kV, square-wave noise by noise simulator (pulse width: 100 ns/1 μs, 1-ns rise)	
Static immunity	Destruction: 8 kV Malfunction: 4 kV	
Enclosure rating	IP20	
Weight	Approx. 18 g	
EMC	Emission Enclosure: EN55011 Group 1 class A Emission AC Mains: EN55011 Group 1 class A Immunity ESD: EN61000-4-2: 4 kV contact discharge (level 2) 8 kV air discharge (level 3) Immunity RF-interference: ENV50140: 10 V/m (amplitude modulated, 80 MHz to 1 GHz) (level 3) 10 V/m (pulse modulated, 900 MHz) Immunity Conducted Disturbance: ENV50141: 10 V (0.15 to 80 MHz) (level 3) Immunity Burst: EN61000-4-4: 2 kV power-line (level 3) 2 kV I/O signal-line (level 4)	
Approved standards	UL508, CSA22.2 No. 14 Conforms to VDE 0435/P2021 (for built-in use) Conforms to EN50081-2, EN50082-2	

# Nomenclature

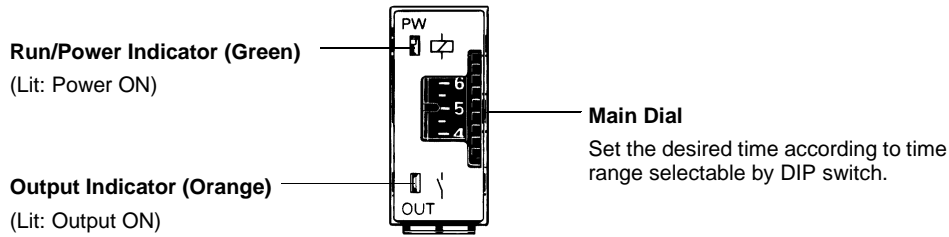

# Operation

## ■ Timing Chart

Operating mode	Timing chart	
	H3RN-1/-11	H3RN-2/-21
<b>ON-delay</b> 		
<b>Interval</b> 		
<b>Flicker OFF-start</b> 		
<b>Flicker ON-start</b> 		

**Note:** t: Set time  
Rt: Reset time

### ■ DIP Switch Settings

The 1-s range and ON-delay mode for H3RN-1/-2, 1-min range and ON-delay mode for H3RN-11/-21 are factory-set before shipping.

#### Time Ranges

Model	Time range	Time setting range	Setting	Factory-set
H3RN-1, H3RN-2	1 s	0.1 to 1 s		Yes
	10 s	1 to 10 s		No
	1 min	0.1 to 1 min		No
	10 min	1 to 10 min		No
H3RN-11, H3RN-21	1 min	0.1 to 1 min		Yes
	10 min	1 to 10 min		No
	1 h	0.1 to 1 h		No
	10 h	1 to 10 h		No

**Note:** The left two DIP switch pins are used to select the time ranges.

#### Operating Modes

Operating mode	Setting	Factory-set
ON-delay		Yes
Interval		No
Flicker OFF-start		No
Flicker ON-start		No

**Note:** The right two DIP switch pins are used to select the operating modes.

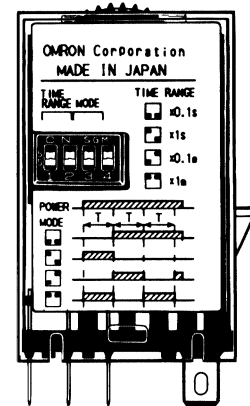

# Dimensions

Note: All units are in millimeters unless otherwise indicated.

## ■ Timers

### H3RN-1/-11 Front Mounting

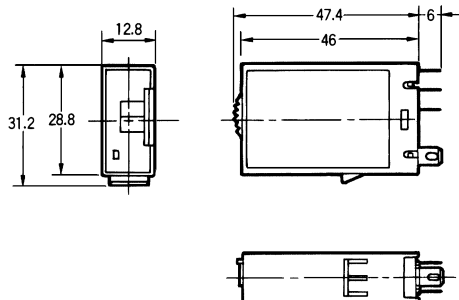
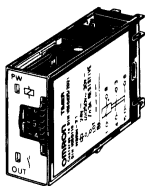

### H3RN-2/-21 Front Mounting

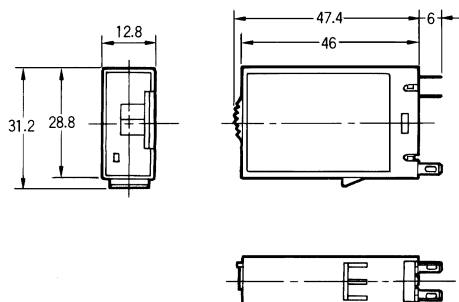
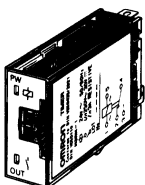

## Mounting Height

Use the P2RF-j -E or P2R-j 7P to mount the H3RN. When ordering any one of these sockets, replace “j” with “05” for SPDT or “08” for DPST-NO.

### P2RF-j -E

### P2R-j 7P

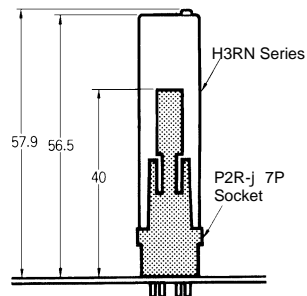
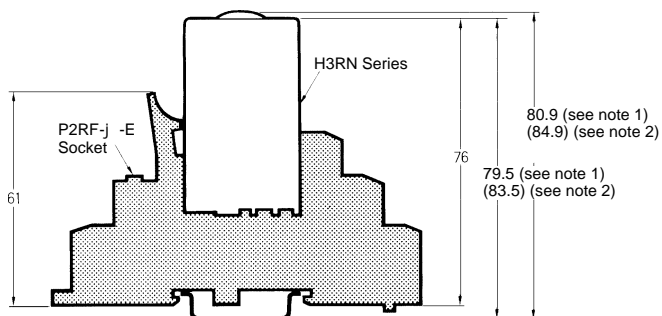

- Note:**
1. The value shown indicates the dimension for the P2RF-05-E with the PFP-j N Mounting Rail. The value is 71.5 mm when using the PFP-Nj 2.
  2. The value shown in parentheses indicates the dimension for the P2RF-08-E with the PFP-j N Mounting Rail. The value is 75.5 mm when using the PFP-Nj 2.

# Installation

## ■ Connection

### H3RN-1/-11

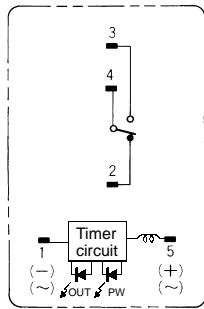

#### DIN Indication

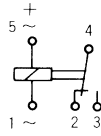

### H3RN-2/-21

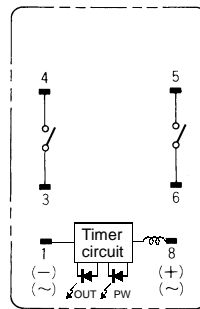

#### DIN Indication

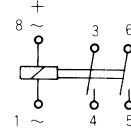

## Pulse Operation

A pulse output for a certain period can be obtained with a random external input signal.

Use the H3RN in interval mode as shown in the following timing charts.

### H3RN-2/-21

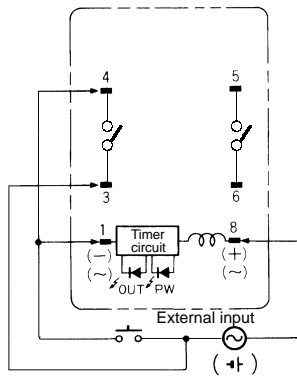

Power (3-8)

External short circuit (1-4)

External input (1-3)

Time limit contact NO (6-5)

Run/Power indicator (PW)  
Output indicator (OUT)

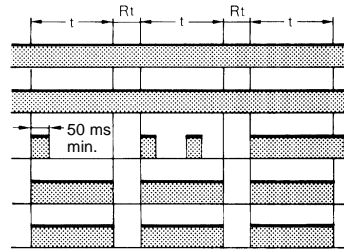

**Note:** t: Set time  
Rt: Reset time

## ⚠ Caution

Be careful when connecting wires.

Mode	Terminals
Pulse operation	Power supply between 3 and 8 Short-circuit between 4 and 1 Input signal between 3 and 1
Operating mode; interval and all other modes	Power supply between 1 and 8

# Precautions

When using the H3RN in any place where the ambient temperature is more than 50°C, supply 90% to 110% of the rated voltages (at 12 VDC: 95% to 110%).

Do not leave the H3RN in time-up condition for a long period of time (for example, more than one month in any place where the ambient temperature is high), otherwise the internal parts may become damaged. Therefore, the use of the H3RN with a relay as shown in the following circuit diagram is recommended.

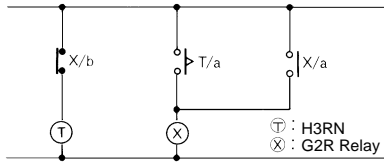

The H3RN must be disconnected from the socket when setting the DIP switch, otherwise the user may touch a terminal imposed with a high voltage and get an electric shock.

Do not connect the H3RN as shown in the following circuit diagram on the right hand side, otherwise the H3RN's internal contacts different from each other in polarity may become short-circuited.

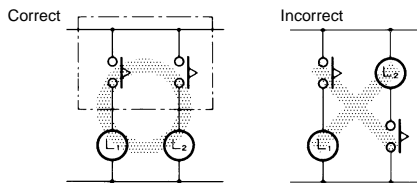

Use the following safety circuit when building a self-holding circuit with the H3RN and an auxiliary relay, such as a G2R Relay, in combination.

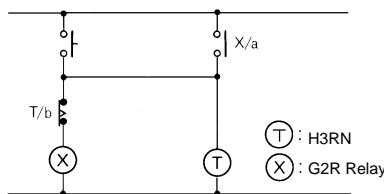

In the case of the above circuit, the H3RN will be in pulse operation. Therefore, if the circuit shown on page 9 is used, no auxiliary relay will be required.

Do not use the SPDT contact in a circuit which may cause short-circuiting at three points (otherwise, short-circuiting of the power supply may occur) because the SPDT contact of H3RN-1/-11 is composed of an SPST-NC contact.

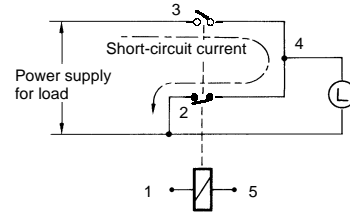

Do not set to the minimum setting in the flicker modes, otherwise the contact may be damaged.

Do not use the H3RN in places where there is excessive dust, corrosive gas, or direct sunlight.

Make sure that there is a space of 3 mm or more between any H3RN Models next to each other. (When using the P2RF-j -E Socket, a space of 3 mm or more will be secured.) If a space of 3 mm or more is not secured, the ambient temperature must be less than 50°C.

The internal parts may become damaged if a supply voltage other than the rated ones is imposed on the H3RN.

## Precautions for VDE Conformance

The H3RN as a built-in timer conforms to VDE 0435/P2021 provided that the following conditions are satisfied.

### Handling

Do not touch the DIP switch while power is supplied to the H3RN.

Before dismantling the H3RN from the socket, make sure that no voltage is imposed on any terminal of the H3RN.

### Wiring

Only a load with basic isolation can be connected to the output contact. The H3RN is a model with basic isolation. Therefore, the H3RN and the load will ensure reinforced isolation, thus meeting VDE standards.

Insulation requirement: Overvoltage category II, pollution degree 2 (with a clearance of 1.5 mm and a creepage distance of 2.5 mm at 240 VAC)





**ALL DIMENSIONS SHOWN ARE IN MILLIMETERS.**

To convert millimeters into inches, multiply by 0.03937. To convert grams into ounces, multiply by 0.03527.

Cat. No. L090-E1-1B **In the interest of product improvement, specifications are subject to change without notice.**

---

## **OMRON Corporation**

Systems Components Division  
28th Fl., Crystal Tower Bldg.  
1-2-27, Shiromi, Chuo-ku,  
Osaka 540 Japan  
Phone: 06-949-6012 Fax: 06-949-6021

Printed in Japan  
0996-2M (0296) a

## X-ON Electronics

Largest Supplier of Electrical and Electronic Components

*Click to view similar products for [Timers](#) category:*

*Click to view products by [Omron](#) manufacturer:*

Other Similar products are found below :

[79237785](#) [H5AN-4DM DC12-24](#) [H5CN-YAN AC100-240](#) [H5CX-L8S-N AC100-240](#) [H5S-WFB2D](#) [H5AN-4D DC12-24](#) [THR2U-110A](#)  
[81506944](#) [88225029](#) [H5S-YB4-X](#) [H7AN-2D DC12-24](#) [H5CN-XANS DC12-48](#) [H7AN-W4DM DC12-24](#) [H7AN-4DM DC12-24](#) [H7AN-4D](#)  
[DC12-24](#) [H7AN-RT6M AC100-240](#) [LT4H-AC24VS](#) [1SVR508020R1100](#) [1SVR508100R0000](#) [1SVR550127R4100](#) [1SVR730010R3200](#)  
[1SVR730020R3300](#) [1SVR730211R2300](#) [1SVR740100R3300](#) [PCU-511UNI](#) [732-0030](#) [H3C-R](#) [H3CR-A8-301 24-48AC/12-48DC](#) [H3CR-](#)  
[A8E 24-48AC/DC](#) [H3CR-F8 100-240AC/100-125DC](#) [H3CR-FN 100-240AC/100-125DC](#) [H3DK-G 24-230AC/DC](#) [H3DK-HBL AC/DC24-48](#)  
[H3DK-M1A DC12](#) [H3DT-A1 24-240AC/DC](#) [LT4H-AC24V](#) [LT4HW8-AC240V](#) [LT4HW-AC240V](#) [LT4HW-AC240VS](#) [LT4HW-AC24VS](#)  
[LT4HW-DC24V](#) [LT4HW-DC24VS](#) [31L48AP](#) [31L48TPM240](#) [RC302](#) [RC312](#) [RE48ACV12MW](#) [REV-201M](#) [RG](#) [AT78041](#)