

Solid-state Timer H3Y Series

Miniature Timer Compatible with the MY Relay



- The Push-In Plus Terminal Block Socket-compatible H3Y-□-B/H3YN-□-B Timers in a black design join the Single-mode H3Y and Multi-mode H3YN.
- The H3Y-□-B and H3YN-□-B are UL listed when they are used together with Push-In Plus Terminal Block Sockets.
- Large transparent time setting knob facilitates time setting.
A flat-blade and Phillips screwdriver can also be used for time setting.
- Conforms to EMC standards.
- Conforms to EN 61812-1 and approved by UL and CSA.



For the most recent information on models that have been certified for safety standards, refer to your OMRON website.

Model Number Structure

The Entire H3Y Series

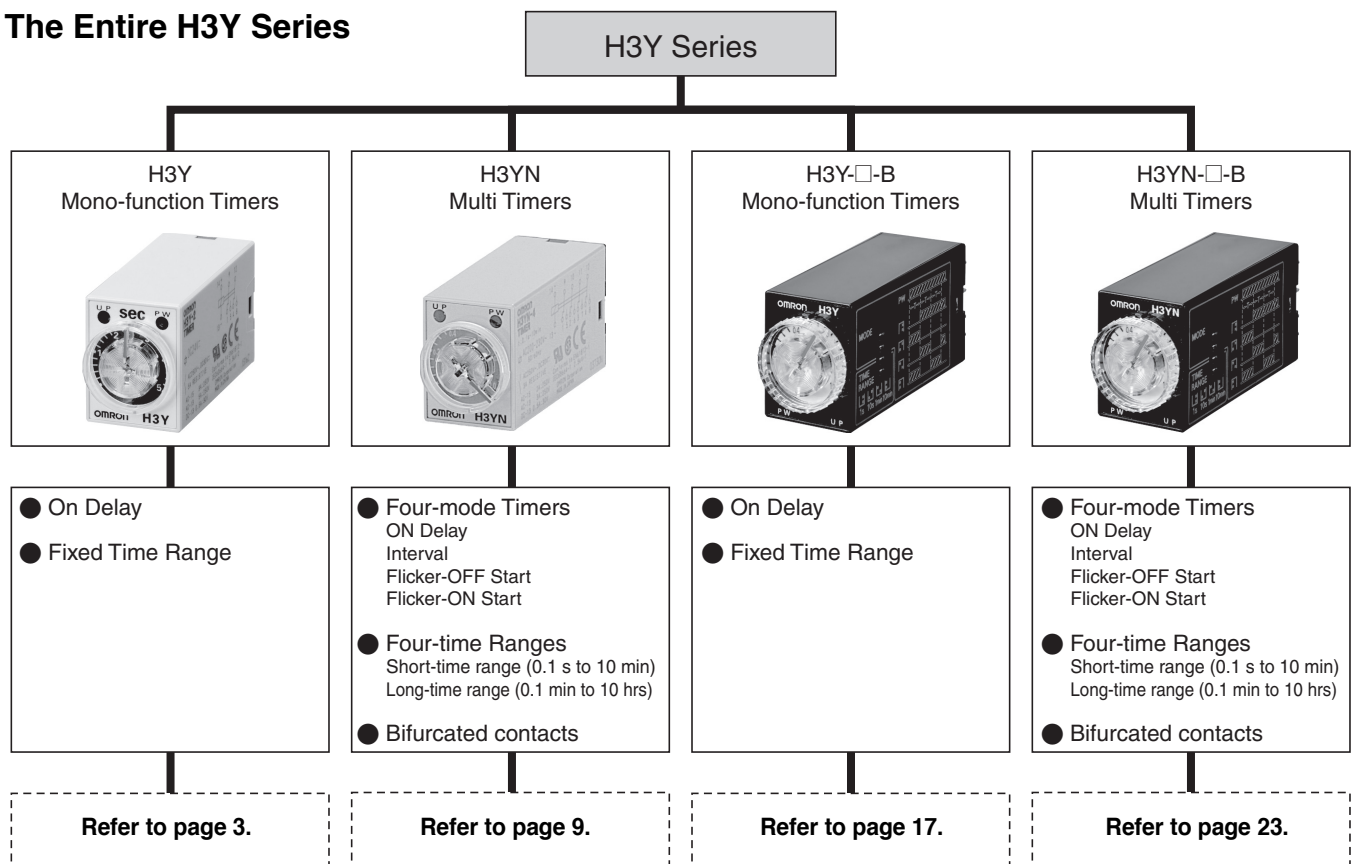

H3Y Series

Model Number Structure

H3Y- \square - \square - \square
 (1) (2) (3)

(1) Output

Symbol	Meaning
2	DPDT
4	4PDT

(2) Terminal Type

Symbol	Meaning
None	Plug-in terminals
0	PCB terminals

(3) Body Color and Terminal Arrangement

Symbol	Meaning
None	Beige with output terminals on top and power supply terminals on bottom
B	Black with power supply terminals on top and output terminals on bottom

Ex) H3Y-2 100 to 120VAC 0.5S

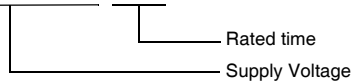

Note: Specify both the model number, supply voltage, and rated time when ordering.

H3YN - \square \square \square - \square
 (1) (2) (3) (4)

(1) Output

Symbol	Meaning
2	DPDT
4	4PDT

(2) Time Range

Symbol	Meaning
None	Short-time range
0	Long-time range

(3) Contact Type

Symbol	Meaning
None	Single contact
Z	Twin contacts

(4) Body Color and Terminal Arrangement

Symbol	Meaning
None	Beige with output terminals on top and power supply terminals on bottom
B	Black with power supply terminals on top and output terminals on bottom

Ex) H3YN-2 100 to 120VAC
 Supply Voltage

Note: Specify both the model number, supply voltage when ordering.

Solid-state Timer H3Y

Miniature Timer Compatible with the MY Relay

- Semi-multi power supply voltage.
- Large transparent time setting knob facilitates time setting.
A flat-blade and Phillips screwdriver can also be used for time setting.
- Pin configuration compatible with MY Power Relay.
- LED indication for power and output statuses.
- Conforms to EMC standards.
- Conforms to EN 61812-1 and approved by UL and CSA.

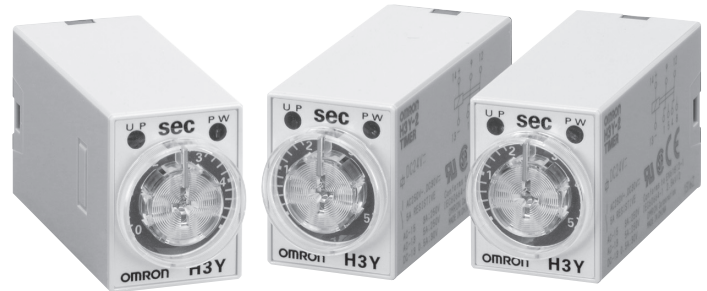

For the most recent information on models that have been certified for safety standards, refer to your OMRON website.

Refer to *Safety Precautions* on page 37.

Ordering Information

Operation/resetting system	Time-limit contact	Time ranges	Supply voltage	Mounting	
				Surface/DIN-track mounting (with socket)	Surface mounting (with PCB terminals)
Time-limit operation/self-resetting	DPDT (for power switching)	0.04 s to 3 h	24, 100 to 120, 200 to 230, 240 VAC (50/60 Hz); 12, 24, 48, 125, 100 to 110 VDC	H3Y-2	H3Y-2-0
	4PDT			H3Y-4 *	H3Y-4-0 *

Note: Sockets and Hold-down Clips are not included with the H3Y. They must be ordered separately.

* Use the H3Y-4 or H3Y-4-0 Series when switching micro loads.

Accessories (Order Separately)

Adapter, Mounting Plate, Hold-down Clips, Terminal covers

Name/specification	Model	
Flush mounting adapter	Y92F-78	
Mounting Plate for Socket	For 1 Socket	PYP-1
	For 18 Sockets	PYP-18
Hold-down Clips	For PYFZ-□ and PYF□A	Y92H-3
	For PY□ and PYF□M	Y92H-4
Terminal covers	For PYFZ-08	PYCZ-C08 (2 pcs/set)
	For PYFZ-14	PYCZ-C14 (1 pcs/set)

Note: For details, refer to *Precautions for H3Y-series Timers* on page 31.

Socket

Timer		Square Sockets			
Contact	Model	Pin	Connection	Terminal	Model
DPDT	H3Y-2	8-pin	Front Connecting	DIN track mounting	PYFZ-08
				DIN track mounting (Finger Protection Structure)	PYFZ-08-E
			Back Connecting	Screw mounting	PYF08M
				Solder terminal PCB terminal	PY08 PY08-02
4PDT	H3Y-4	14-pin	Front Connecting	DIN track mounting	PYFZ-14
				DIN track mounting (Finger Protection Structure)	PYFZ-14-E
			Back Connecting	Solder terminal PCB terminal	PY14 PY14-02

- Note:**
1. Cannot be used with the H3Y-□-0 (PCB terminals).
 2. The PYFZ-□-E and PYF□A-E have a finger-protection structure. Round crimp terminals cannot be used. Use forked crimp terminals.
 3. For details, refer to *Precautions for H3Y-series Timers* on page 31.

H3Y

Specifications

Time Ranges

Rated time	Time setting range	Rated time	Time setting range
0.5 s	0.04 to 0.5 s	3 min	0.1 to 3 min
1 s	0.1 to 1 s	5 min	0.2 to 5 min
5 s	0.2 to 5 s	10 min	0.5 to 10 min
10 s	0.5 to 10 s	30 min	1 to 30 min
30 s	1.0 to 30 s	60 min	2 to 60 min
60 s	2.0 to 60 s	3 h	0.1 to 3 h
120 s	5.0 to 120 s	---	---

Ratings

Item	H3Y-2(-0)/H3Y-4(-0)
Rated supply voltage *6, *7	100 to 120 (50/60 Hz), 200 to 230 VAC (50/60 Hz), 24 VAC (50/60 Hz) *1 12, 24, 48, 125, 100 to 110 VDC *2, *3
Operating voltage range	All rated voltages except 12 VDC: 85% to 110% of rated supply voltage 12 VDC: 90% to 110% of rated supply voltage *4
Reset voltage	10% min. of rated supply voltage *5
Power consumption	100 to 120 VAC: 1.5 VA (at 120 VAC) 200 to 230 VAC: 1.8 VA (at 230 VAC) 24 VAC: 1.5 VA (at 24 VAC) 12 VDC: 0.9 W (at 12 VDC) 24 VDC: 0.9 W (at 24 VDC) 48 VDC: 1.0 W (at 48 VDC) 100 to 110 VDC: 1.3 W (at 110 VDC) 125 VDC: 1.3 W (at 125 VDC)
Control outputs	H3Y-2(-0): 5 A at 250 VAC, resistive load ($\cos\phi = 1$) The minimum applicable load is 1 mA at 5 VDC (P reference value). Contact materials: Ag H3Y-4(-0): 3 A at 250 VAC, resistive load ($\cos\phi = 1$) The minimum applicable load is 1 mA at 1 VDC (P reference value). Contact materials: Au-clad + Ag-alloy
Ambient operating temperature	-10°C to 50°C (with no icing)
Storage temperature	-25°C to 65°C
Ambient operating humidity	35% to 85%

*1. Do not use the output from an inverter as the power supply. Refer to *Safety Precautions for All Timers* for details on your OMRON website.

*2. With DC ratings, single-phase full-wave rectified power sources may be used.

*3. Only the H3Y-2 and H3Y-2-0 Series include 12 VDC models.

*4. Use the Timer within 90% to 110% of the rated supply voltage (95% to 110% for 12 VDC) when using it continuously under an ambient operating temperature of 50°C.

*5. Set the reset voltage as follows to ensure proper resetting.

100 to 120 VAC: 10 VAC max.

200 to 230 VAC: 20 VAC max.

100 to 110 VDC: 10 VDC max.

*6. Refer to *Safety Precautions for All Timers* on your OMRON website when combining the Timer with an AC 2-wire proximity sensor.

*7. A diode to prevent reverse voltages is provided only on models with a DC power supply.

Characteristics

Accuracy of operating time	±1% FS max. (0.5 s range: ±1%±10 ms max.) *1
Setting error	±10%±50 ms FS max.
Reset time	Min. power-opening time: 0.1 s max. (including halfway reset)
Influence of voltage	±2% FS max. *1
Influence of temperature	±2% FS max. *1
Insulation resistance	100 MΩ min. (at 500 VDC)
Dielectric strength	2,000 VAC, 50/60 Hz for 1 min (between current-carrying terminals and exposed non-current-carrying metal parts) *2 2,000 VAC, 50/60 Hz for 1 min (between operating power circuit and control output) *2 2,000 VAC, 50/60 Hz for 1 min (between different pole contacts; 2-pole model) *2 1,500 VAC, 50/60 Hz for 1 min (between different pole contacts; 4-pole model) 1,000 VAC, 50/60 Hz for 1 min (between non-continuous contacts)
Impulse withstand voltage	Between power terminals: 3 kV for 100 to 120 VAC, 200 to 230 VAC, 100 to 110 VDC, 125 VDC 1 kV for 12 VDC, 24 VDC, 48 VDC Between exposed non-current-carrying metal parts: 4.5 kV for 100 to 120 VAC, 200 to 230 VAC, 100 to 110 VDC, 125 VDC 1.5 kV for 12 VDC, 24 VDC, 48 VDC
Noise immunity	±1.5 kV, square-wave noise by noise simulator (pulse width: 100 ns/1 μs, 1-ns rise)
Static immunity	Destruction: 8 kV Malfunction: 4 kV
Vibration resistance	Destruction: 10 to 55 Hz, 0.75-mm single amplitude Malfunction: 10 to 55 Hz, 0.5-mm single amplitude
Shock resistance	Destruction: 1,000 m/s ² (approx. 100G) *3 Malfunction: 100 m/s ² (approx. 10G)
Life expectancy	Mechanical: 10,000,000 operations min. (under no load at 1,800 operations/h) Electrical: H3Y-2: 500,000 operations min. (5 A at 250 VAC, resistive load at 1800 operations/h) H3Y-4: 200,000 operations min. (3 A at 250 VAC, resistive load at 1800 operations/h) *4
Enclosure rating	IP40
Weight	Approx. 50 g
EMC	(EMI) EN 61812-1 Emission Enclosure: EN 55011 Group 1 class A Emission AC Mains: EN 55011 Group 1 class A (EMS) EN 61812-1 Immunity ESD: IEC 61000-4-2 Immunity RF-interference: IEC 61000-4-3 Immunity Burst: IEC 61000-4-4 Immunity Surge: IEC 61000-4-5 Immunity Conducted Disturbance: IEC 61000-4-6 Immunity Voltage Dip/Interruption: IEC 61000-4-11
Approved standards	UL 508, CSA C22.2 No. 14, Lloyds, CCC: GB/T 14048.5 *6 Conforms to EN 61812-1 and IEC 60664-1. (2.5 kV/2 for H3Y-2/-2-0, 2.5 kV/1 for H3Y-4/-4-0) *5

*1. Add ±10 mS to the above value for the 0.5-S range model.

*2. Terminal screw sections are excluded.

*3. The destructive shock resistance test was performed on the Timer.

*4. Check the electrical life curve.

*5. Overvoltage category II.

*6. CCC certification requirements

Model	H3Y-2 (-0)	H3Y-4 (-0)
Recommended fuse	RT14-20/6A (380 VAC 6 A), manufactured by DELIXI	RT14-20/4A (380 VAC 4 A), manufactured by DELIXI
Rated operating voltage U _e Rated operating current I _e	AC-15: U _e : 250 VAC, I _e : 3 A AC-13: U _e : 250 VAC, I _e : 5 A DC-13: U _e : 30 VDC, I _e : 0.5 A	AC-15: U _e : 250 VAC, I _e : 2 A AC-13: U _e : 250 VAC, I _e : 3 A DC-13: U _e : 30 VDC, I _e : 0.5 A
Rated insulation voltage	250 V	
Rated impulse withstand voltage (altitude: 2,000 m max.)	2.5 kV (at 240 VAC)	
Conditional short-circuit current	1000 A	

H3Y-2, H3Y-2-0

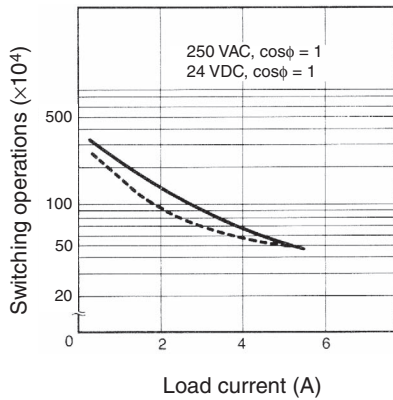

H3Y-2, H3Y-2-0

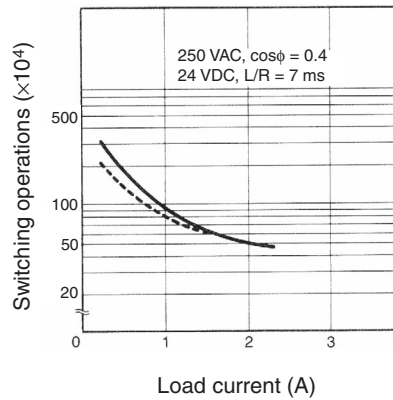

Reference: A maximum current of 0.6 A can be switched at 125 VDC ($\cos\phi = 1$).
 Maximum current of 0.2 A can be switched if L/R is 7 ms. In both cases, a life of 100,000 operations can be expected. The minimum applicable load is 1 mA at 5 VDC (P reference value).

H3Y-4, H3Y-4-0

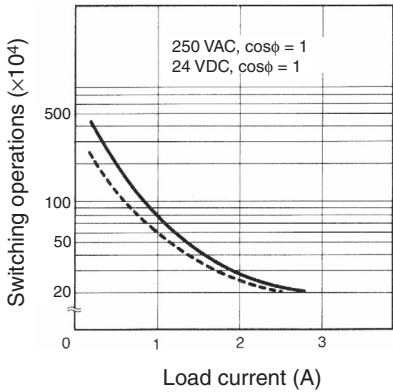

H3Y-4, H3Y-4-0

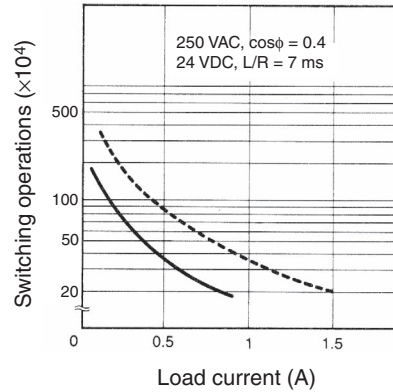

Reference: A maximum current of 0.5 A can be switched at 125 VDC ($\cos\phi = 1$).
 Maximum current of 0.2 A can be switched if L/R is 7 ms. In both cases, a life of 100,000 operations can be expected. The minimum applicable load is 1 mA at 1 VDC (P reference value).

Connections

Connections

H3Y-2, H3Y-2-0

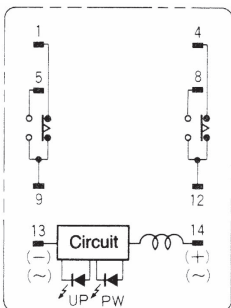

(Bottom View)

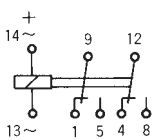

(DIN notation)

Connect the DC power supply to terminals 13 and 14 according to the polarity marks.

H3Y-4, H3Y-4-0

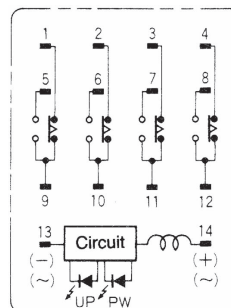

(Bottom View)

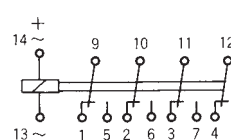

(DIN notation)

Connect the DC power supply to terminals 13 and 14 according to the polarity marks.

Operation

Timing Chart

H3Y-2, H3Y-2-0

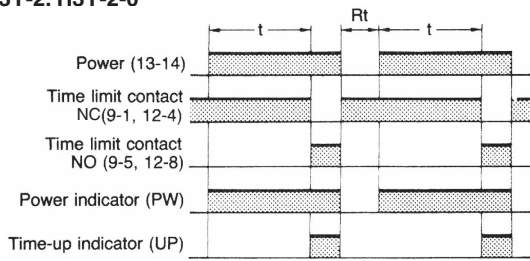

Note: t = Set time
Rt = Reset time

H3Y-4, H3Y-4-0

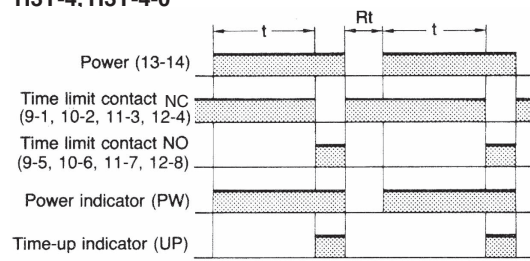

Note: t = Set time
Rt = Reset time

Nomenclature

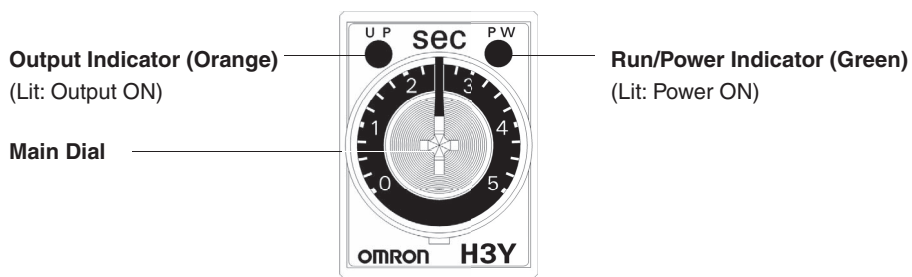

H3Y

Dimensions

(Unit: mm)

Timers

H3Y-2

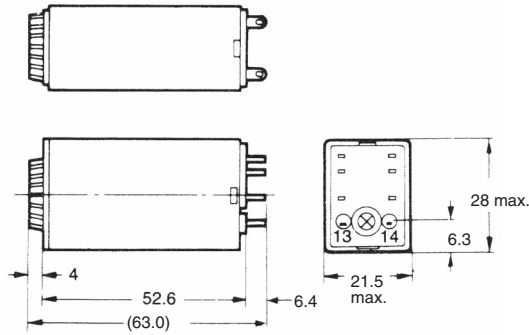

H3Y-2-0

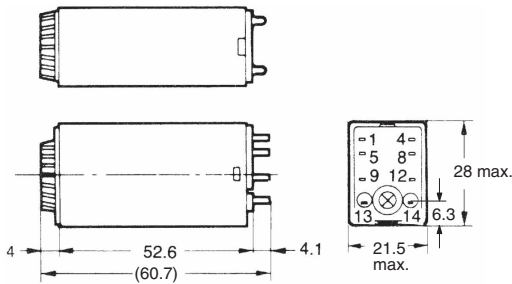

Mounting Holes

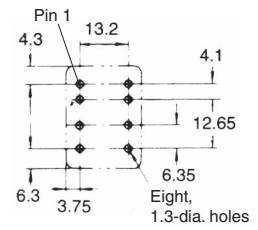

H3Y-4

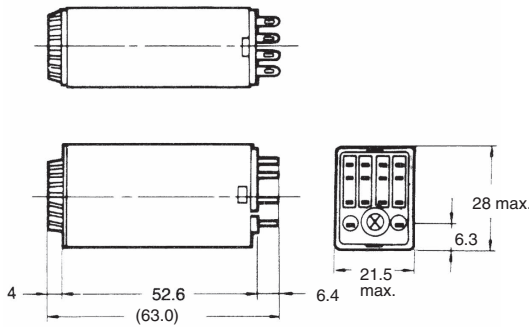

H3Y-4-0

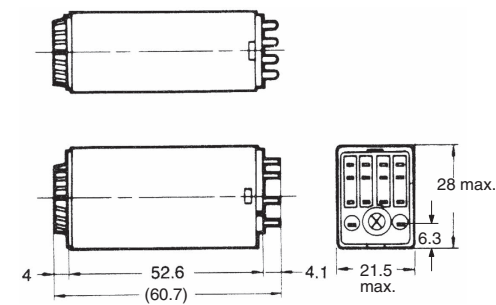

Mounting Holes

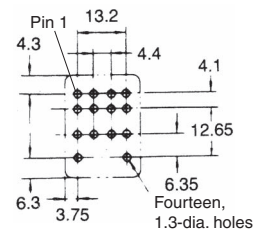

Solid-state Timer H3YN

Miniature Timer with Multiple Time Ranges and Multiple Operating Modes



- Minimizes stock.
- Pin configuration compatible with MY Power Relay.
- Standard multiple operating modes and multiple time ranges.
- Conforms to EN 61812-1 and IEC 60664-1 for Low Voltage, and EMC Directives



Refer to *Safety Precautions* on page 37.

For the most recent information on models that have been certified for safety standards, refer to your OMRON website.

Ordering Information

List of Models

Supply voltage	Time-limit contact	Short-time range model (0.1 s to 10 min)	Long-time range model (0.1 min to 10 h)
24, 100 to 120, 200 to 230 VAC; 12, 24, 48, 100 to 110, 125 VDC	DPDT	H3YN-2	H3YN-21
	4PDT	H3YN-4 *1	H3YN-41 *1
24 VDC	4PDT (Twin contacts)	H3YN-4-Z *1, *2	H3YN-41-Z *1, *2

Note: Sockets and Hold-down Clips are not included with the H3YN. They must be ordered separately.

*1. Use the H3YN-4 or H3YN-41 Series when switching micro loads, and use the H3YN-4-Z or H3YN-41-Z Series when switching even smaller loads.

*2. Only models with 24 VDC power supply are available.

Accessories (Order Separately)

Adapter, Mounting Plate, Hold-down Clips, Terminal covers

Name/specification	Model	
Flush mounting adapter	Y92F-78	
Mounting Plate for Socket	For 1 Socket	PYP-1
	For 18 Sockets	PYP-18
Hold-down Clips	For PYFZ-□ and PYF□A	Y92H-3
	For PY□ and PYF□M	Y92H-4
Terminal covers	For PYFZ-08	PYCZ-C08 (2 pcs/set)
	For PYFZ-14	PYCZ-C14 (1 pcs/set)

Note: For details, refer to *Precautions for H3Y-series Timers* on page 31.

Socket

Timer		Square Sockets			
Contact	Model	Pin	Connection	Terminal	Model
DPDT	H3YN-2□	8-pin	Front Connecting	DIN track mounting	PYFZ-08
				DIN track mounting (Finger Protection Structure)	PYFZ-08-E
			Back Connecting	Screw mounting	PYF08M
				Solder terminal	PY08
4PDT	H3YN-4□	14-pin	Front Connecting	PCB terminal	PY08-02
				DIN track mounting	PYFZ-14
			Back Connecting	DIN track mounting (Finger Protection Structure)	PYFZ-14-E
				Solder terminal	PY14
PCB terminal	PY14-02				

Note: 1. Cannot be used with the H3Y-□-0 (PCB terminals).

2. The PYFZ-□-E and PYF□A-E have a finger-protection structure. Round crimp terminals cannot be used. Use forked crimp terminals.

3. For details, refer to *Precautions for H3Y-series Timers* on page 31.

H3YN

Specifications

Ratings

Item	H3YN-2/-4/-4-Z	H3YN-21/-41/-41-Z
Time ranges	0.1 s to 10 min (1 s, 10 s, 1 min, or 10 min max. selectable)	0.1 min to 10 h (1 min, 10 min, 1 h, or 10 h max. selectable)
Rated supply voltage *5, *6	24, 100 to 120, 200 to 230 VAC (50/60 Hz) *1 12, 24, 48, 100 to 110, 125 VDC *2	
Pin type	Plug-in	
Operating mode	ON-delay, interval, flicker OFF start, or flicker ON start (selectable with DIP switch)	
Operating voltage range	85% to 110% of rated supply voltage (12 VDC: 90% to 110% of rated supply voltage) *3	
Reset voltage	10% min. of rated supply voltage *4	
Power consumption	100 to 120 VAC: Relay ON: Approx. 1.8 VA (1.6 W) at 120 VAC, 60 Hz Relay OFF: Approx. 1 VA (0.6 W) at 120 VAC, 60 Hz 200 to 230 VAC: Relay ON: Approx. 2.2 VA (1.8 W) at 230 VAC, 60 Hz Relay OFF: Approx. 1.5 VA (1.1 W) at 230 VAC, 60 Hz 24 VAC: Relay ON: Approx. 1.8 VA (1.4 W) at 24 VAC, 60 Hz Relay OFF: Approx. 0.3 VA (0.2 W) at 24 VAC, 60 Hz 12 VDC: Relay ON: Approx. 1.1 W at 12 VDC Relay OFF: Approx. 0.1 W at 12 VDC 24 VDC: Relay ON: Approx. 1.1 W at 24 VDC Relay OFF: Approx. 0.1 W at 24 VDC 48 VDC: Relay ON: Approx. 1.2 W at 48 VDC Relay OFF: Approx. 0.3 W at 48 VDC 100 to 110 VDC: Relay ON: Approx. 1.6 W at 110 VDC Relay OFF: Approx. 0.4 W at 110 VDC 125 VDC: Relay ON: Approx. 1.6 W at 125 VDC Relay OFF: Approx. 0.4 W at 125 VDC	
Control outputs	DPDT: 5 A at 250 VAC, resistive load ($\cos\phi = 1$) The minimum applicable load is 1 mA at 5 VDC (P reference value). Contact materials: Ag 4PDT: 3 A at 250 VAC, resistive load ($\cos\phi = 1$) H3YN-4/-41 series: The minimum applicable load is 1 mA at 1 VDC (P reference value). H3YN-4-Z/-41-Z series: The minimum applicable load is 1 mA at 1 VDC (P reference value). Contact materials: Au-clad + Ag-alloy	
Ambient operating temperature	-10°C to 50°C (with no icing)	
Storage temperature	-25°C to 65°C	
Ambient operating humidity	35% to 85%	

*1. Do not use the output from an inverter as the power supply. Refer to *Safety Precautions for All Timers* for details on your OMRON website.

*2. Single-phase, full-wave-rectified power supplies can be used.

*3. When using the H3YN continuously in any place where the ambient temperature is in a range of 45°C to 50°C, supply 90% to 110% of the rated supply voltages (supply 95% to 110% with 12 VDC type).

*4. Set the reset voltage as follows to ensure proper resetting.

100 to 120 VAC: 10 VAC max.

200 to 230 VAC: 20 VAC max.

100 to 110 VDC: 10 VDC max.

*5. Refer to *Safety Precautions for All Timers* on your OMRON website when combining the Timer with an AC 2-wire proximity sensor.

*6. A diode to prevent reverse voltages is provided only on models with a DC power supply.

Characteristics

Item	H3YN-2/-21/-4/-41
Accuracy of operating time	±1% FS max. (1 s range: ±1%±10 ms max.)
Setting error	±10%±50 ms FS max.
Reset time	Min. power-opening time: 0.1 s max. (including halfway reset)
Influence of voltage	±2% FS max.
Influence of temperature	±2% FS max.
Insulation resistance	100 MΩ min. (at 500 VDC)
Dielectric strength	2,000 VAC, 50/60 Hz for 1 min (between current-carrying terminals and exposed non-current-carrying metal parts) *1 2,000 VAC, 50/60 Hz for 1 min (between operating power circuit and control output) 2,000 VAC, 50/60 Hz for 1 min (between different pole contacts; 2-pole model) 1,500 VAC, 50/60 Hz for 1 min (between different pole contacts; 4-pole model) 1,000 VAC, 50/60 Hz for 1 min (between non-continuous contacts)
Vibration resistance	Destruction: 10 to 55 Hz, 0.75-mm single amplitude for 1 h each in 3 directions Malfunction: 10 to 55 Hz, 0.5-mm single amplitude for 10 min each in 3 directions
Shock resistance	Destruction: 1,000 m/s ² *2 Malfunction: 100 m/s ²
Life expectancy	Mechanical: 10,000,000 operations min. (under no load at 1,800 operations/h) Electrical: DPDT: 500,000 operations min. (5 A at 250 VAC, resistive load at 1,800 operations/h) 4PDT: 200,000 operations min. (H3YN-4-Z/-41-Z: 100,000 operations min.) (3 A at 250 VAC, resistive load at 1,800 operations/h) *3
Impulse withstand voltage	Between power terminals: 3 kV for 100 to 120 VAC, 200 to 230 VAC, 100 to 110 VDC, 125 VDC 1 kV for 12 VDC, 24 VDC, 48 VDC, 24 VAC Between exposed non-current-carrying metal parts: 4.5 kV for 100 to 120 VAC, 200 to 230 VAC, 100 to 110 VDC, 125 VDC 1.5 kV for 12 VDC, 24 VDC, 48 VDC, 24 VAC
Noise immunity	±1.5 kV, square-wave noise by noise simulator (pulse width: 100 ns/1 μs, 1-ns rise)
Static immunity	Destruction: 8 kV Malfunction: 4 kV
Degree of protection	IP40
Weight	Approx. 50 g
EMC	(EMI) Emission Enclosure: EN 61812-1 EN 55011 Group 1 class A Emission AC Mains: EN 55011 Group 1 class A (EMS) Immunity ESD: IEC 61000-4-2 Immunity RF-interference: IEC 61000-4-3 Immunity Burst: IEC 61000-4-4 Immunity Surge: IEC 61000-4-5 Immunity Conducted Disturbance: IEC 61000-4-6 Immunity Voltage Dip/Interruption: IEC 61000-4-11
Approved standards	UL 508, CSA C22.2 No. 14, Lloyds, CCC: GB/T 14048.5 *5 Conforms to EN 61812-1 and IEC 60664-1. (2.5 kV/2 for H3YN-2/-21, 2.5 kV/1 for H3YN-4/-41, H3YN-4-Z/-41-Z) *4

*1. Terminal screw sections are excluded.

*2. The destructive shock resistance test was performed on the Timer.

*3. Refer to the *Life-test Curve*.

*4. Overvoltage category II.

*5. CCC certification requirements

Model	H3YN-2/-21	H3YN-4/-41
Recommended fuse	RT14-20/6A (380 VAC 6 A), manufactured by DELIXI	RT14-20/4A (380 VAC 4 A), manufactured by DELIXI
Rated operating voltage U _e Rated operating current I _e	AC-15: U _e : 250 VAC, I _e : 3 A AC-13: U _e : 250 VAC, I _e : 5 A DC-13: U _e : 30 VDC, I _e : 0.5 A	AC-15: U _e : 250 VAC, I _e : 2 A AC-13: U _e : 250 VAC, I _e : 3 A DC-13: U _e : 30 VDC, I _e : 0.5 A
Rated insulation voltage	250 V	
Rated impulse withstand voltage (altitude: 2,000 m max.)	2.5 kV (at 240 VAC)	
Conditional short-circuit current	1000 A	

Life-test Curve (Reference Value)

H3YN-2/-21

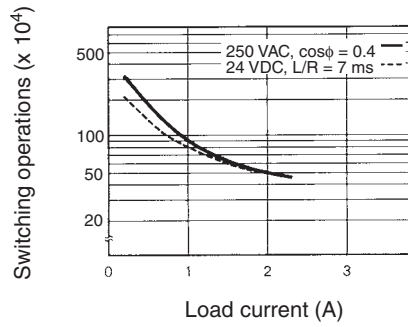
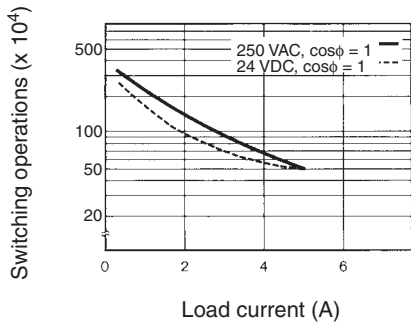

Reference: A maximum current of 0.6 A can be switched at 125 VDC (cosφ = 1).
Maximum current of 0.2 A can be switched if L/R is 7 ms. In both cases, a
life of 100,000 operations can be expected.
 The minimum applicable load is 1 mA at 5 VDC (P reference value)

H3YN-4/-41

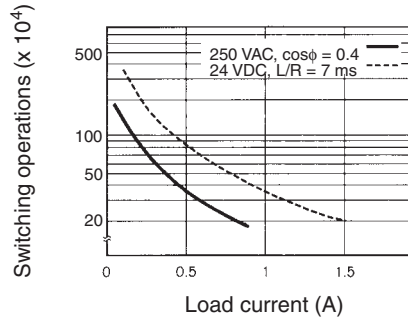
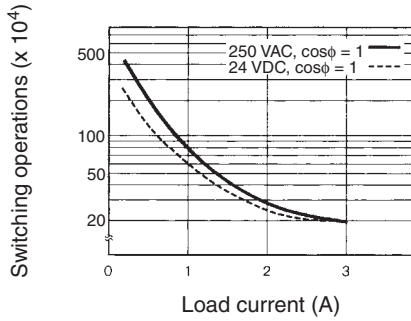

Reference: A maximum current of 0.5 A can be switched at 125 VDC (cosφ = 1).
Maximum current of 0.2 A can be switched if L/R is 7 ms. In both cases, a
life of 100,000 operations can be expected.
 The minimum applicable load is 1 mA at 1 VDC (P reference value)

H3YN-4-Z/-41-Z

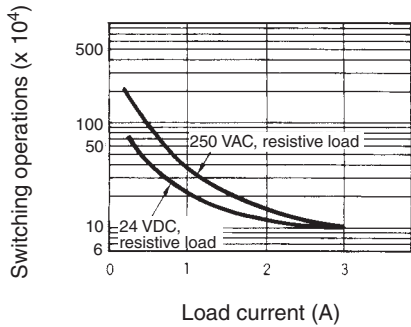

Reference: A maximum current of 0.5 A can be switched at 125 VDC (cosφ = 1).
Maximum current of 0.2 A can be switched if L/R is 7 ms. In both cases, a
life of 100,000 operations can be expected.
 The minimum applicable load is 0.1 mA at 1 VDC (P reference value)

Connections

Connection

H3YN-2/-21

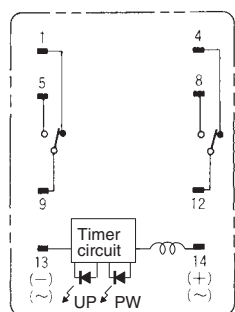

(Bottom View)

DIN Indication

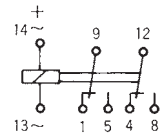

H3YN-4/-41 H3YN-4-Z/-41-Z

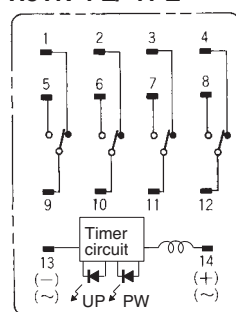

(Bottom View)

DIN Indication

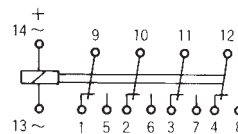

Pulse Operation

A pulse output for a certain period can be obtained with a random external input signal. Use the H3YN in interval mode as shown in the following timing charts.

H3YN-2/-21

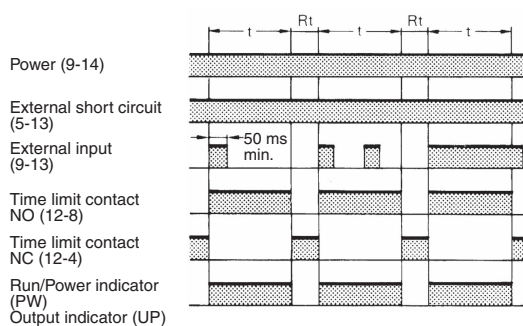
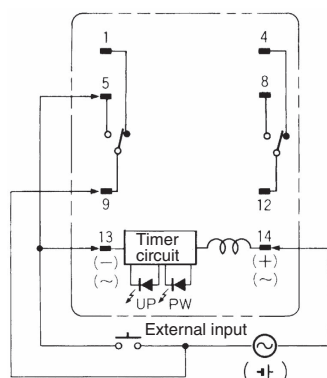

Note: t: Set time
Rt: Reset time

H3YN-4/-41 H3YN-4-Z/-41-Z

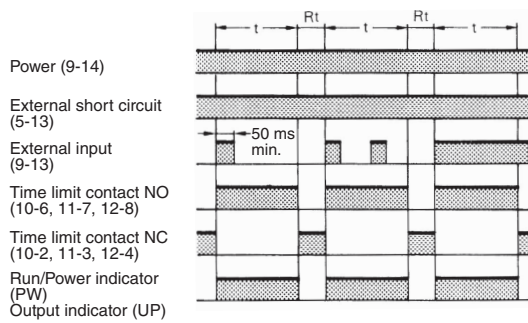
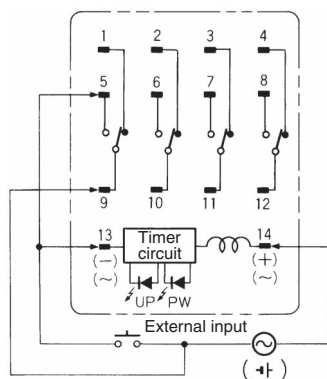

Note: t: Set time
Rt: Reset time

Caution
Be careful when connecting wires.

Mode	Terminals
Pulse operation	Power supply between 9 and 14 Short-circuit between 5 and 13 Input signal between 9 and 13
Operating mode; interval and all other modes	Power supply between 13 and 14

H3YN

Nomenclature

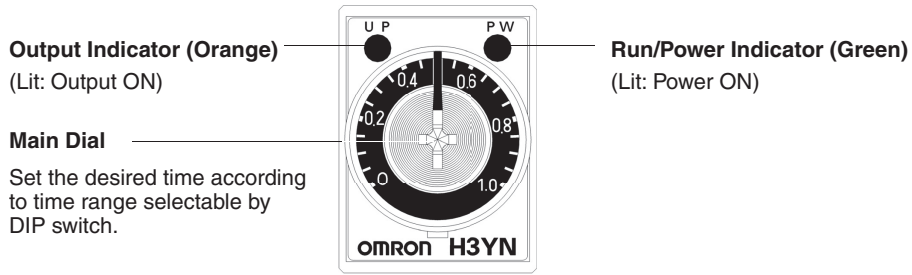

Dimensions

(Unit: mm)

Timers

H3YN-2/-21 Front Mounting

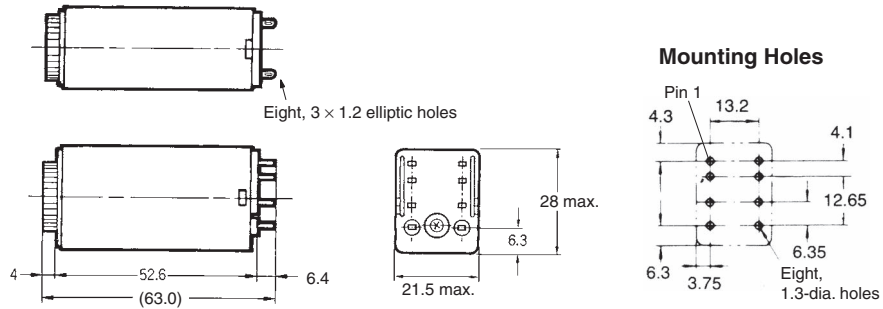

H3YN-4/-41 Front Mounting H3YN-4-Z/-41-Z

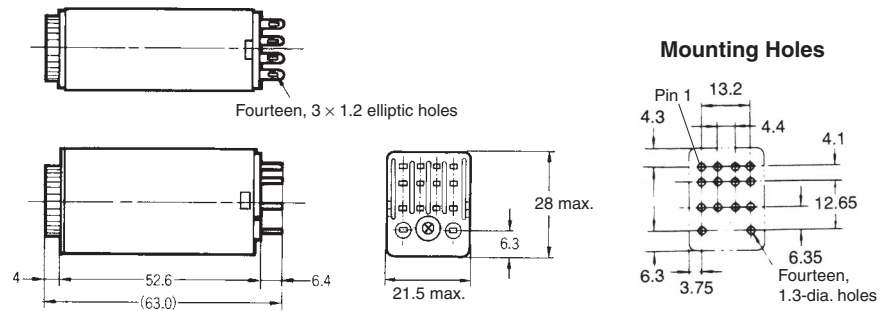

Operation

DIP Switch Settings

The 1-s range and ON-delay mode for H3YN-2/-4/-4-Z, the 1-min range and ON-delay mode for H3YN-21/-41/-41-Z are factory-set before shipping.

Time Ranges

Model	Time range	Time setting range	Setting	Factory-set
H3YN-2, H3YN-4 H3YN-4-Z	1 s	0.1 to 1 s		Yes
	10 s	1 to 10 s		No
	1 min	0.1 to 1 min		No
	10 min	1 to 10 min		No
H3YN-21, H3YN-41 H3YN-41-Z	1 min	0.1 to 1 min		Yes
	10 min	1 to 10 min		No
	1 h	0.1 to 1 h		No
	10 h	1 to 10 h		No

Note: The top two DIP switch pins are used to select the time ranges.

Operating Modes

Operating mode	Setting	Factory-set
ON-delay		Yes
Interval		No
Flicker OFF-start		No
Flicker ON-start		No

Note: The bottom two DIP switch pins are used to select the operating mode.

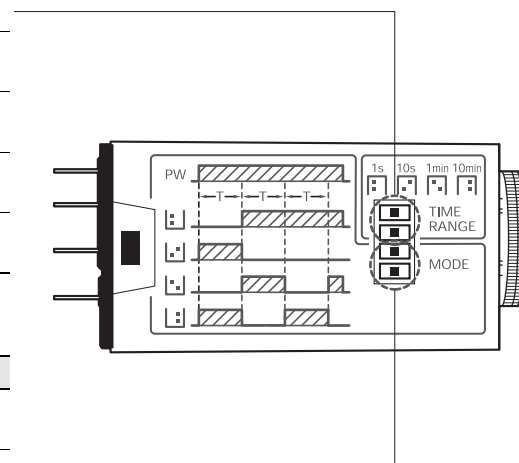

Timing Chart

Operating mode	Timing chart	
	H3YN-2/-21	H3YN-4/-41
ON-delay 		
Interval 		
Flicker OFF-start 		
Flicker ON-start 		

Note: t: Set time
Rt: Reset time

Solid-state Timer

H3Y-□-B

Miniature Timer Compatible with the MY Relay



- UL listed when used with a Push-In Plus Terminal Block Socket. *
Conforms to CSA, CE Marking, CCC and LR.
 - Black design with power supply terminals on top and contact output terminals on bottom.
 - Large transparent time setting knob facilitates time setting.
A flat-blade and Phillips screwdriver can also be used for time setting.
 - Semi-multi power supply voltage.
- * When used in combination with a Push-In Plus Terminal Block Socket (PYF-□-PU-L).



For the most recent information on models that have been certified for safety standards, refer to your OMRON website.

Refer to *Safety Precautions* on page 37.

Ordering Information

Operation/resetting system	Time-limit contact	Time ranges	Supply voltage	Mounting
				Surface/DIN-track mounting (with socket)
Time-limit operation/self-resetting	DPDT (for power switching)	0.04 s to 3 h	100 to 120, 200 to 230 VAC (50/60 Hz); 12, 24, 48, 100 to 110 VDC	H3Y-2-B
	4PDT			H3Y-4-B *

Note: Sockets and Hold-down Clips are not included with the H3Y-B. They must be ordered separately.
* Use the H3Y-4-B Series when switching micro loads.

Accessories (Order Separately)

Hold-down Clips

Name/specification	Model
Hold-down Clips For PYF-□-PU-L	Y92H-3

Note: For details, refer to *Precautions for H3Y-series Timers* on page 31.

Socket

Timer		Square Sockets				
Contact	Model	Pin	Connection	Terminal	Model	Terminal Type
DPDT	H3Y-2-B	8-pin	Front Connecting	DIN track mounting	PYF-08-PU-L	Push-In Plus Terminal Block
4PDT	H3Y-4-B	14-pin	Front Connecting	DIN track mounting	PYF-14-PU-L	Push-In Plus Terminal Block

Note: 1. Cannot be used with the H3Y-□-0 (PCB terminals).
2. For details, refer to *Precautions for H3Y-series Timers* on page 31.

H3Y-□-B

Specifications

Time Ranges

Rated time	Time setting range	Rated time	Time setting range
0.5 s	0.04 to 0.5 s	3 min	0.1 to 3 min
1 s	0.1 to 1 s	5 min	0.2 to 5 min
5 s	0.2 to 5 s	10 min	0.5 to 10 min
10 s	0.5 to 10 s	30 min	1 to 30 min
30 s	1.0 to 30 s	60 min	2 to 60 min
60 s	2.0 to 60 s	3 h	0.1 to 3 h
120 s	5.0 to 120 s	---	---

Ratings

Item	H3Y-2-B/H3Y-4-B
Rated supply voltage *6, *7	100 to 120 (50/60 Hz), 200 to 230 VAC (50/60 Hz), 24 VAC (50/60 Hz) *1 12, 24, 48, 125, 100 to 110 VDC *2, *3
Operating voltage range	All rated voltages except 12 VDC: 85% to 110% of rated supply voltage 12 VDC: 90% to 110% of rated supply voltage *4
Reset voltage	10% min. of rated supply voltage *5
Power consumption	100 to 120 VAC: 1.5 VA (at 120 VAC) 200 to 230 VAC: 1.8 VA (at 230 VAC) 24 VAC: 1.5 VA (at 24 VAC) 12 VDC: 0.9 W (at 12 VDC) 24 VDC: 0.9 W (at 24 VDC) 48 VDC: 1.0 W (at 48 VDC) 100 to 110 VDC: 1.3 W (at 110 VDC) 125 VDC: 1.3 W (at 125 VDC)
Control outputs	H3Y-2-B: 5 A at 250 VAC, resistive load (cosφ = 1) The minimum applicable load is 1 mA at 5 VDC (P reference value). Contact materials: Ag H3Y-4-B: 3 A at 250 VAC, resistive load (cosφ = 1) The minimum applicable load is 1 mA at 1 VDC (P reference value). Contact materials: Au-clad + Ag-alloy
Ambient operating temperature	-10°C to 55°C (with no icing)
Storage temperature	-25°C to 65°C
Ambient operating humidity	35% to 85%

*1. Do not use the output from an inverter as the power supply. Refer to *Safety Precautions for All Timers* for details on your OMRON website.

*2. With DC ratings, single-phase full-wave rectified power sources may be used.

*3. Only the H3Y-2-B Series include 12 VDC models.

*4. Use the Timer within 90% to 110% of the rated supply voltage (95% to 110% for 12 VDC) when using it continuously under an ambient operating temperature of 50°C.

*5. Set the reset voltage as follows to ensure proper resetting.

100 to 120 VAC: 10 VAC max.

200 to 230 VAC: 20 VAC max.

100 to 110 VDC: 10 VDC max.

*6. Refer to *Safety Precautions for All Timers* on your OMRON website when combining the Timer with an AC 2-wire proximity sensor.

*7. A diode to prevent reverse voltages is provided only on models with a DC power supply.

Characteristics

Accuracy of operating time	±1% FS max. (0.5 s range: ±1%±10 ms max.) *1
Setting error	±10%±50 ms FS max.
Reset time	Min. power-opening time: 0.1 s max. (including halfway reset)
Influence of voltage	±2% FS max. *1
Influence of temperature	±2% FS max. *1
Insulation resistance	100 MΩ min. (at 500 VDC)
Dielectric strength	2,000 VAC, 50/60 Hz for 1 min (between current-carrying terminals and exposed non-current-carrying metal parts) *2 2,000 VAC, 50/60 Hz for 1 min (between operating power circuit and control output) *2 2,000 VAC, 50/60 Hz for 1 min (between different pole contacts; 2-pole model) *2 1,500 VAC, 50/60 Hz for 1 min (between different pole contacts; 4-pole model) 1,000 VAC, 50/60 Hz for 1 min (between non-continuous contacts)
Impulse withstand voltage	Between power terminals: 3 kV for 100 to 120 VAC, 200 to 230 VAC, 100 to 110 VDC, 125 VDC 1 kV for 12 VDC, 24 VDC, 48 VDC Between exposed non-current-carrying metal parts: 4.5 kV for 100 to 120 VAC, 200 to 230 VAC, 100 to 110 VDC, 125 VDC 1.5 kV for 12 VDC, 24 VDC, 48 VDC
Noise immunity	±1.5 kV, square-wave noise by noise simulator (pulse width: 100 ns/1 μs, 1-ns rise)
Static immunity	Destruction: 8 kV Malfunction: 4 kV
Vibration resistance	Destruction: 10 to 55 Hz, 0.75-mm single amplitude Malfunction: 10 to 55 Hz, 0.5-mm single amplitude
Shock resistance	Destruction: 1,000 m/s ² (approx. 100G) *3 Malfunction: 100 m/s ² (approx. 10G)
Life expectancy	Mechanical: 10,000,000 operations min. (under no load at 1,800 operations/h) Electrical: H3Y-2-B: 500,000 operations min. (5 A at 250 VAC, resistive load at 1800 operations/h) H3Y-4-B: 200,000 operations min. (3 A at 250 VAC, resistive load at 1800 operations/h) *4
Enclosure rating	IP40
Weight	Approx. 50 g
EMC	(EMI) EN 61812-1 Emission Enclosure: EN 55011 Group 1 class A Emission AC Mains: EN 55011 Group 1 class A (EMS) EN 61812-1 Immunity ESD: IEC 61000-4-2 Immunity RF-interference: IEC 61000-4-3 Immunity Burst: IEC 61000-4-4 Immunity Surge: IEC 61000-4-5 Immunity Conducted Disturbance: IEC 61000-4-6 Immunity Voltage Dip/Interruption: IEC 61000-4-11
Approved standards	UL 508/CSA C22.2 No.14 *5, CSA C22.2 No.14, Lloyds, CCC: GB/T 14048.5 *7 Conforms to EN 61812-1 and IEC 60664-1. (2.5 kV/2 for H3Y-2-B *6, 2.5 kV/1 for H3Y-4-B *6)

*1. Add ±10 mS to the above value for the 0.5-S range model.

*2. Terminal screw sections are excluded.

*3. The destructive shock resistance test was performed on the Timer.

*4. Check the electrical life curve.

*5. cULus listing applies when the OMRON PYF-□-PU-L is used.

cURus recognition applies when any other socket is used.

*6. Overvoltage category II.

*7. CCC certification requirements

Model	H3Y-2-B	H3Y-4-B
Recommended fuse	RT14-20/6A (380 VAC 6 A), manufactured by DELIXI	RT14-20/4A (380 VAC 4 A), manufactured by DELIXI
Rated operating voltage Ue Rated operating current Ie	AC-15: Ue: 250 VAC, Ie: 3 A AC-13: Ue: 250 VAC, Ie: 5 A DC-13: Ue: 30 VDC, Ie: 0.5 A	AC-15: Ue: 250 VAC, Ie: 2 A AC-13: Ue: 250 VAC, Ie: 3 A DC-13: Ue: 30 VDC, Ie: 0.5 A
Rated insulation voltage	250 V	
Rated impulse withstand voltage (altitude: 2,000 m max.)	2.5 kV (at 240 VAC)	
Conditional short-circuit current	1000 A	

H3Y-2-B

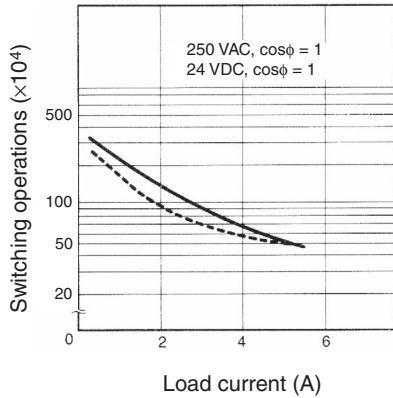

H3Y-2-B

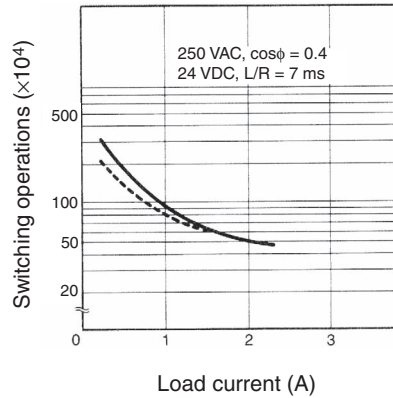

Reference: A maximum current of 0.6 A can be switched at 125 VDC ($\cos\phi = 1$).
Maximum current of 0.2 A can be switched if L/R is 7 ms. In both cases, a life of 100,000 operations can be expected. The minimum applicable load is 1 mA at 5 VDC (P reference value).

H3Y-4-B

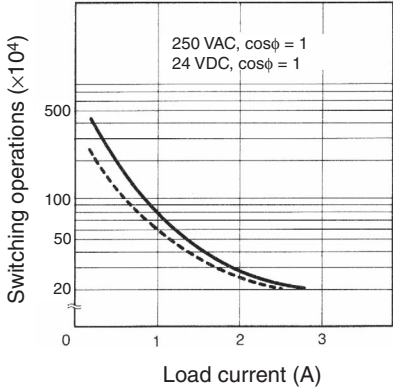

H3Y-4-B

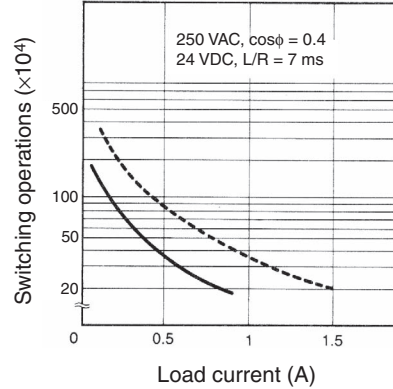

Reference: A maximum current of 0.5 A can be switched at 125 VDC ($\cos\phi = 1$).
Maximum current of 0.2 A can be switched if L/R is 7 ms. In both cases, a life of 100,000 operations can be expected. The minimum applicable load is 1 mA at 1 VDC (P reference value).

Connections

Connections

H3Y-2-B

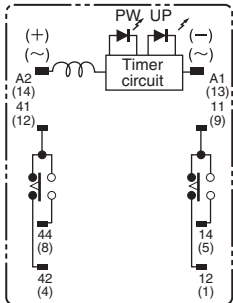

(Bottom View)

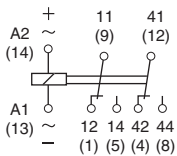

(DIN notation)

H3Y-4-B

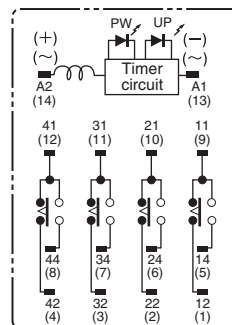

(Bottom View)

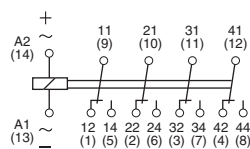

(DIN notation)

Connect the DC power supply to terminals A1(13) and A2(14) according to the polarity marks.

Connect the DC power supply to terminals A1(13) and A2(14) according to the polarity marks.

Operation

Timing Chart

H3Y-2-B

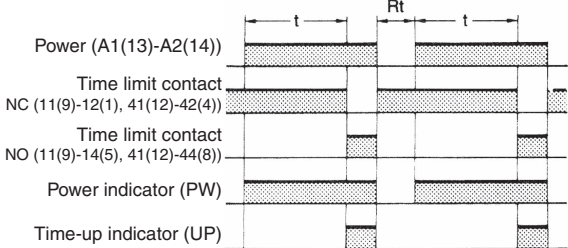

Note: t = Set time
 Rt = Reset time

H3Y-4-B

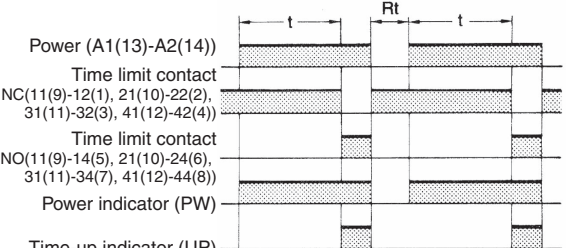

Note: t = Set time
 Rt = Reset time

Nomenclature

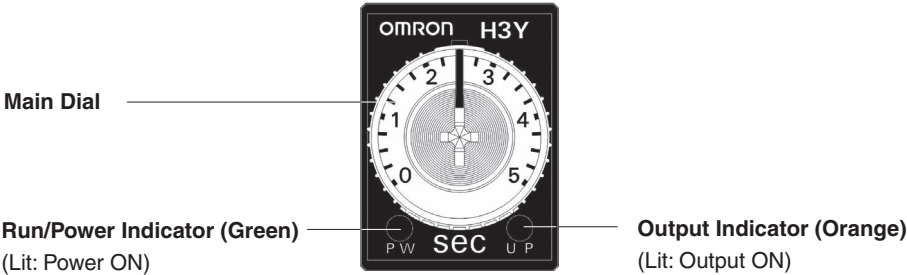

H3Y-□-B

Dimensions

(Unit: mm)

Timers

H3Y-2-B

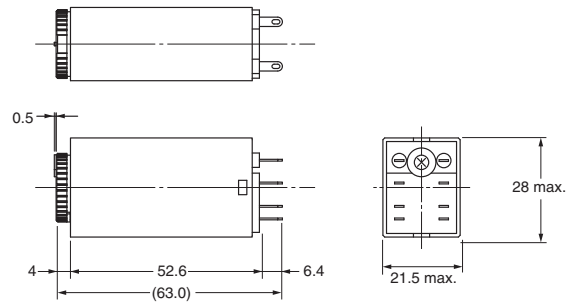

H3Y-4-B

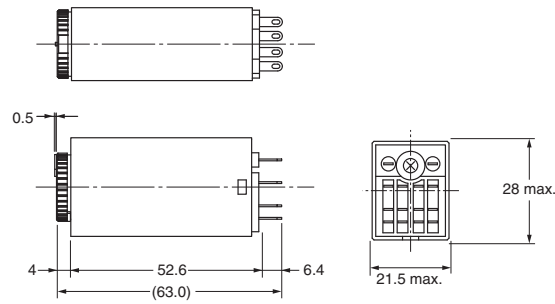

Solid-state Timer

H3YN-□-B

Miniature Timer with Multiple Time Ranges and Multiple Operating Modes



- UL listed when used with a Push-In Plus Terminal Block Socket. *
Conforms to CSA, CE Marking, LR, and CCC.
- Black design with power supply terminals on top and contact output terminals on bottom.
- Standard multiple operating modes and multiple time ranges.
- Pin configuration compatible with MY Power Relay.
- Minimizes stock.

* When used in combination with a Push-In Plus Terminal Block Socket (PYF-□-PU-L).



For the most recent information on models that have been certified for safety standards, refer to your OMRON website.

Refer to *Safety Precautions* on page 38.

Ordering Information

List of Models

Supply voltage	Time-limit contact	Short-time range model (0.1 s to 10 min)	Long-time range model (0.1 min to 10 h)
24, 100 to 120, 200 to 230 VAC; 12, 24, 48, 100 to 110, 125 VDC	DPDT	H3YN-2-B	H3YN-21-B
	4PDT	H3YN-4-B *1	H3YN-41-B *1
24 VDC	4PDT (Twin contacts)	H3YN-4-Z-B *1, *2	H3YN-41-Z-B *1, *2

Note: 1. Sockets and Hold-down Clips are not included with the H3YN-B. They must be ordered separately.

*1. Use the H3YN-4-B or H3YN-41-B Series when switching micro loads, and use the H3YN-4-Z-B or H3YN-41-Z-B Series when switching even smaller loads.

*2. Only models with 24 VDC power supply are available.

Accessories (Order Separately)

Hold-down Clips

Name/specification	Model
Hold-down Clips For PYF-□-PU-L	Y92H-3

Note: For details, refer to *Precautions for H3Y-series Timers* on page 31.

Socket

Timer		Square Sockets				
Contact	Model	Pin	Connection	Terminal	Model	Terminal Type
DPDT	H3YN-2□-B	8-pin	Front Connecting	DIN track mounting	PYF-08-PU-L	Push-In Plus Terminal Block
4PDT	H3YN-4□-B	14-pin	Front Connecting	DIN track mounting	PYF-14-PU-L	Push-In Plus Terminal Block

Note: 1. Cannot be used with the H3YN-□-0 (PCB terminals).

2. For details, refer to *Precautions for H3Y-series Timers* on page 31.

Specifications

Ratings

Item	H3YN-2-B/-4-B/-4-Z-B	H3YN-21-B/-41-B/-41-Z-B
Time ranges	0.1 s to 10 min (1 s, 10 s, 1 min, or 10 min max. selectable)	0.1 min to 10 h (1 min, 10 min, 1 h, or 10 h max. selectable)
Rated supply voltage *5, *6	24, 100 to 120, 200 to 230 VAC (50/60 Hz) *1 12, 24, 48, 100 to 110, 125 VDC *2	
Pin type	Plug-in	
Operating mode	ON-delay, interval, flicker OFF start, or flicker ON start (selectable with DIP switch)	
Operating voltage range	85% to 110% of rated supply voltage (12 VDC: 90% to 110% of rated supply voltage) *3	
Reset voltage	10% min. of rated supply voltage *4	
Power consumption	100 to 120 VAC: Relay ON: Approx. 1.8 VA (1.6 W) at 120 VAC, 60 Hz Relay OFF: Approx. 1 VA (0.6 W) at 120 VAC, 60 Hz 200 to 230 VAC: Relay ON: Approx. 2.2 VA (1.8 W) at 230 VAC, 60 Hz Relay OFF: Approx. 1.5 VA (1.1 W) at 230 VAC, 60 Hz 24 VAC: Relay ON: Approx. 1.8 VA (1.4 W) at 24 VAC, 60 Hz Relay OFF: Approx. 0.3 VA (0.2 W) at 24 VAC, 60 Hz 12 VDC: Relay ON: Approx. 1.1 W at 12 VDC Relay OFF: Approx. 0.1 W at 12 VDC 24 VDC: Relay ON: Approx. 1.1 W at 24 VDC Relay OFF: Approx. 0.1 W at 24 VDC 48 VDC: Relay ON: Approx. 1.2 W at 48 VDC Relay OFF: Approx. 0.3 W at 48 VDC 100 to 110 VDC: Relay ON: Approx. 1.6 W at 110 VDC Relay OFF: Approx. 0.4 W at 110 VDC 125 VDC: Relay ON: Approx. 1.6 W at 125 VDC Relay OFF: Approx. 0.4 W at 125 VDC	
Control outputs	DPDT: 5 A at 250 VAC, resistive load ($\cos\phi = 1$) The minimum applicable load is 1 mA at 5 VDC (P reference value). Contact materials: Ag 4PDT: 3 A at 250 VAC, resistive load ($\cos\phi = 1$) H3YN-4-B/-41-B series: The minimum applicable load is 1 mA at 1 VDC (P reference value). H3YN-4-Z-B/-41-Z-B series: The minimum applicable load is 1 mA at 1 VDC (P reference value). Contact materials: Au-clad + Ag-alloy	
Ambient operating temperature	-10°C to 55°C (with no icing)	
Storage temperature	-25°C to 65°C	
Ambient operating humidity	35% to 85%	

*1. Do not use the output from an inverter as the power supply. Refer to *Safety Precautions for All Timers* for details on your OMRON website.

*2. Single-phase, full-wave-rectified power supplies can be used.

*3. When using the H3YN-B continuously in any place where the ambient temperature is in a range of 45°C to 50°C, supply 90% to 110% of the rated supply voltages (supply 95% to 110% with 12 VDC type).

*4. Set the reset voltage as follows to ensure proper resetting.

100 to 120 VAC: 10 VAC max.

200 to 230 VAC: 20 VAC max.

100 to 110 VDC: 10 VDC max.

*5. Refer to *Safety Precautions for All Timers* on your OMRON website when combining the Timer with an AC 2-wire proximity sensor.

*6. A diode to prevent reverse voltages is provided only on models with a DC power supply.

Characteristics

Item	H3YN-2-B/-21-B/-4-B/-41-B
Accuracy of operating time	±1% FS max. (1 s range: ±1%±10 ms max.)
Setting error	±10%±50 ms FS max.
Reset time	Min. power-opening time: 0.1 s max. (including halfway reset)
Influence of voltage	±2% FS max.
Influence of temperature	±2% FS max.
Insulation resistance	100 MΩ min. (at 500 VDC)
Dielectric strength	2,000 VAC, 50/60 Hz for 1 min (between current-carrying terminals and exposed non-current-carrying metal parts) *1 2,000 VAC, 50/60 Hz for 1 min (between operating power circuit and control output) 2,000 VAC, 50/60 Hz for 1 min (between different pole contacts; 2-pole model) 1,500 VAC, 50/60 Hz for 1 min (between different pole contacts; 4-pole model) 1,000 VAC, 50/60 Hz for 1 min (between non-continuous contacts)
Vibration resistance	Destruction: 10 to 55 Hz, 0.75-mm single amplitude for 1 h each in 3 directions Malfunction: 10 to 55 Hz, 0.5-mm single amplitude for 10 min each in 3 directions
Shock resistance	Destruction: 1,000 m/s ² Malfunction: 100 m/s ²
Life expectancy	Mechanical: 10,000,000 operations min. (under no load at 1,800 operations/h) Electrical: DPDT: 500,000 operations min. (5 A at 250 VAC, resistive load at 1,800 operations/h) 4PDT: 200,000 operations min. (H3YN-4-Z/-41-Z: 100,000 operations min.) (3 A at 250 VAC, resistive load at 1,800 operations/h) *2
Impulse withstand voltage	Between power terminals: 3 kV for 100 to 120 VAC, 200 to 230 VAC, 100 to 110 VDC, 125 VDC 1 kV for 12 VDC, 24 VDC, 48 VDC, 24 VAC Between exposed non-current-carrying metal parts: 4.5 kV for 100 to 120 VAC, 200 to 230 VAC, 100 to 110 VDC, 125 VDC 1.5 kV for 12 VDC, 24 VDC, 48 VDC, 24 VAC
Noise immunity	±1.5 kV, square-wave noise by noise simulator (pulse width: 100 ns/1 μs, 1-ns rise)
Static immunity	Destruction: 8 kV Malfunction: 4 kV
Degree of protection	IP40
Weight	Approx. 50 g
EMC	(EMI) EN 61812-1 Emission Enclosure: EN 55011 Group 1 class A Emission AC Mains: EN 55011 Group 1 class A (EMS) EN 61812-1 Immunity ESD: IEC 61000-4-2 Immunity RF-interference: IEC 61000-4-3 Immunity Burst: IEC 61000-4-4 Immunity Surge: IEC 61000-4-5 Immunity Conducted Disturbance: IEC 61000-4-6 Immunity Voltage Dip/Interruption: IEC 61000-4-11
Approved standards	cULus (or cURus): UL 508/CSA C22.2 No.14 *3, CSA C22.2 No.14, Lloyds, CCC: GB/T 14048.5 *5 Conforms to EN 61812-1 and IEC 60664-1. (2.5 kV/2 for H3YN-2-B/-21-B *4, 2.5 kV/1 for H3YN-4-B/-41-B, H3YN-4-Z-B/-41-Z-B *4)

*1. Terminal screw sections are excluded.

*2. Refer to the *Life-test Curve*.

*3. cULus listing applies when the OMRON PYF-□-PU-L is used.

cURus recognition applies when any other socket is used.

*4. Overvoltage category II

*5. CCC certification requirements

Model	H3YN-2-B/21-B	H3YN-4-B/41-B
Recommended fuse	RT14-20/6A (380 VAC 6 A), manufactured by DELIXI	RT14-20/4A (380 VAC 4 A), manufactured by DELIXI
Rated operating voltage U _e Rated operating current I _e	AC-15: U _e : 250 VAC, I _e : 3 A AC-13: U _e : 250 VAC, I _e : 5 A DC-13: U _e : 30 VDC, I _e : 0.5 A	AC-15: U _e : 250 VAC, I _e : 2 A AC-13: U _e : 250 VAC, I _e : 3 A DC-13: U _e : 30 VDC, I _e : 0.5 A
Rated insulation voltage	250 V	
Rated impulse withstand voltage (altitude: 2,000 m max.)	2.5 kV (at 240 VAC)	
Conditional short-circuit current	1000 A	

Life-test Curve (Reference Value)

H3YN-2-B/-21-B

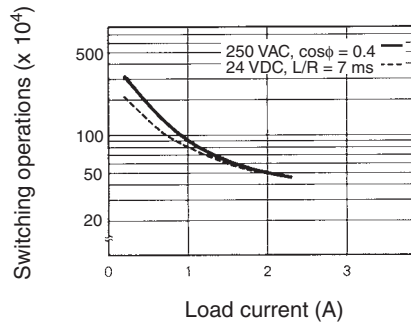
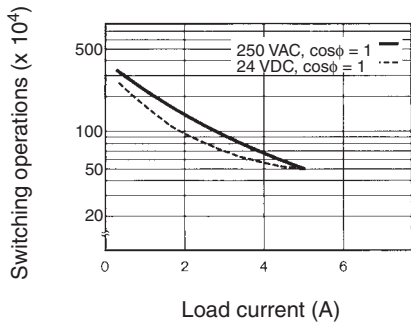

Reference: A maximum current of 0.6 A can be switched at 125 VDC (cosφ = 1).
Maximum current of 0.2 A can be switched if L/R is 7 ms. In both cases, a
life of 100,000 operations can be expected.
 The minimum applicable load is 1 mA at 5 VDC (P reference value)

H3YN-4-B/-41-B

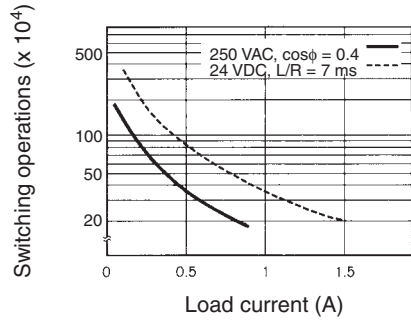
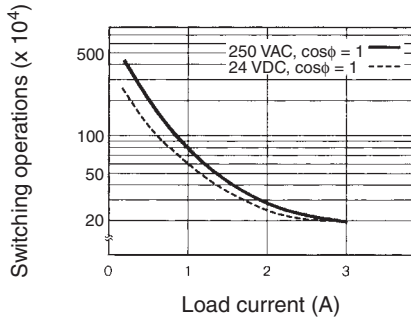

Reference: A maximum current of 0.5 A can be switched at 125 VDC (cosφ = 1).
Maximum current of 0.2 A can be switched if L/R is 7 ms. In both cases, a
life of 100,000 operations can be expected.
 The minimum applicable load is 1 mA at 1 VDC (P reference value)

H3YN-4-Z-B/-41-Z-B

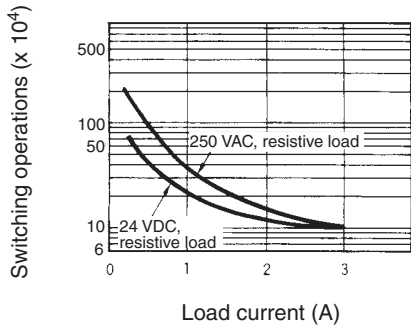

Reference: A maximum current of 0.5 A can be switched at 125 VDC (cosφ = 1).
Maximum current of 0.2 A can be switched if L/R is 7 ms. In both cases, a
life of 100,000 operations can be expected.
 The minimum applicable load is 0.1 mA at 1 VDC (P reference value)

Connections

Connection

H3YN-2-B/-21-B

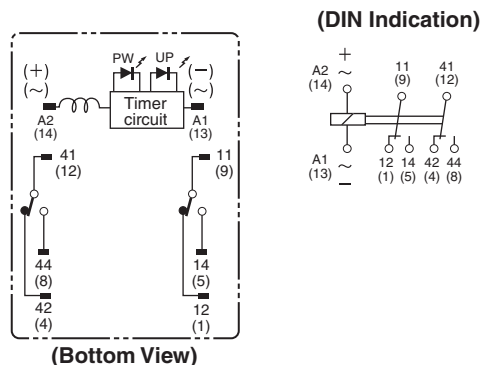

H3YN-4-B/-41-B H3YN-4-Z-B/-41-Z-B

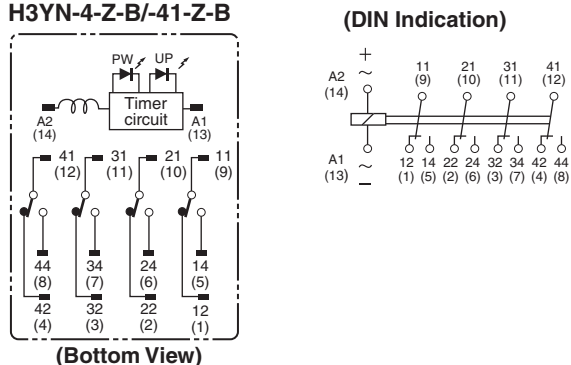

Pulse Operation

A pulse output for a certain period can be obtained with a random external input signal. Use the H3YN-B in interval mode as shown in the following timing charts.

H3YN-2-B/-21-B

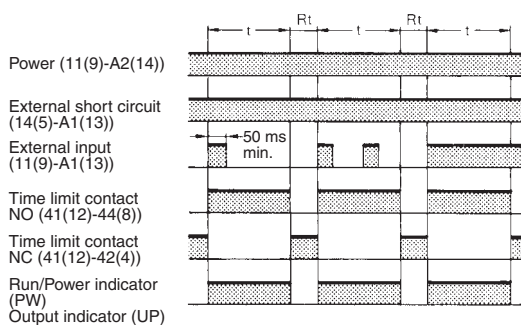
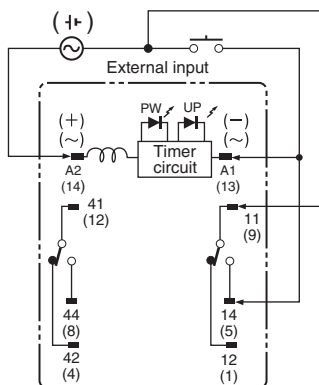

Note: t: Set time
Rt: Reset time

H3YN-4-B/-41-B H3YN-4-Z-B/-41-Z-B

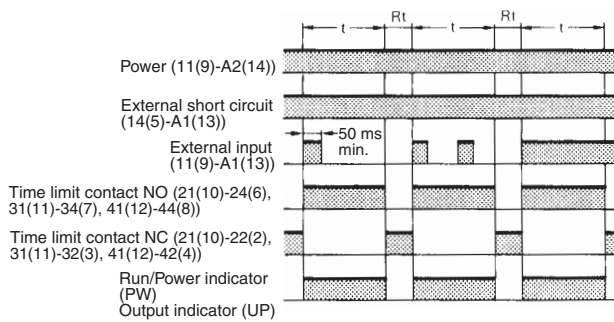
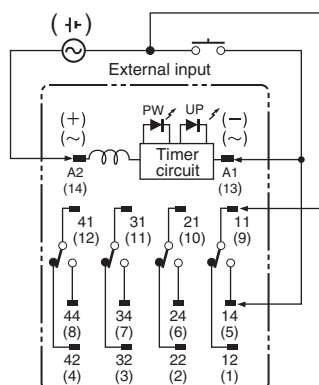

Note: t: Set time
Rt: Reset time

Caution
Be careful when connecting wires.

Mode	Terminals
Pulse operation	Power supply between 11(9) and A2(14) Short-circuit between 14(5) and A1(13) Input signal between 11(9) and A1(13)
Operating mode; interval and all other modes	Power supply between A1(13) and A2(14)

H3YN-□-B

Nomenclature

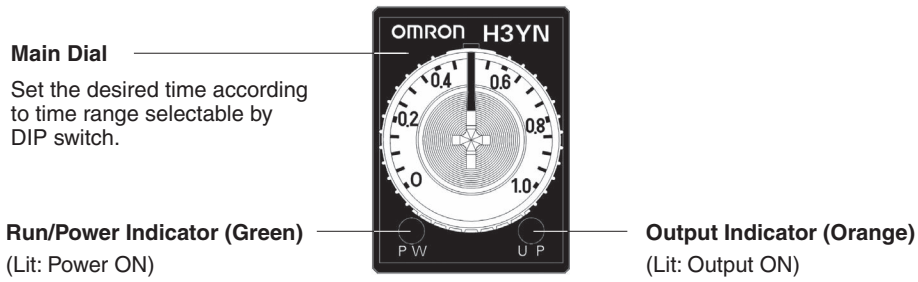

Dimensions

(Unit: mm)

Timers

H3YN-2-B/-21-B Front Mounting

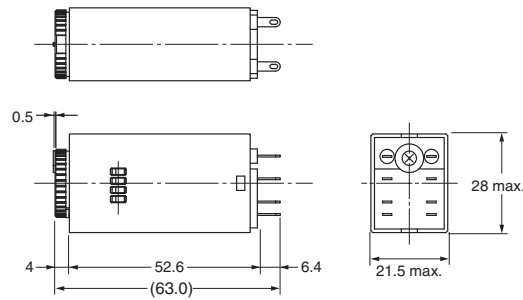

H3YN-4-B/-41-B Front Mounting H3YN-4-Z-B/-41-Z-B

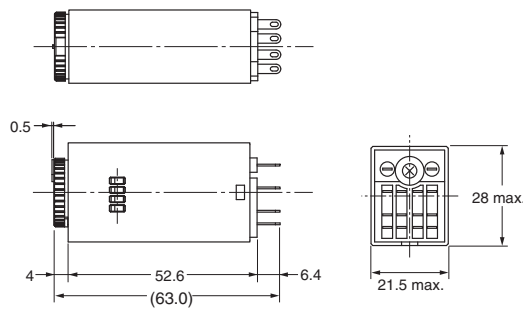

Operation

DIP Switch Settings

The 1-s range and ON-delay mode for H3YN-2-B/-4-B/-4-Z-B, the 1-min range and ON-delay mode for H3YN-21-B/-41-B/-41-Z-B are factory-set before shipping.

Time Ranges

Model	Time range	Time setting range	Setting	Factory-set
H3YN-2-B, H3YN-4-B H3YN-4-Z-B	1 s	0.1 to 1 s		Yes
	10 s	1 to 10 s		No
	1 min	0.1 to 1 min		No
	10 min	1 to 10 min		No
H3YN-21-B, H3YN-41-B H3YN-41-Z-B	1 min	0.1 to 1 min		Yes
	10 min	1 to 10 min		No
	1 h	0.1 to 1 h		No
	10 h	1 to 10 h		No

Note: The top two DIP switch pins are used to select the time ranges.

Operating Modes

Operating mode	Setting	Factory-set
ON-delay		Yes
Interval		No
Flicker OFF-start		No
Flicker ON-start		No

Note: The bottom two DIP switch pins are used to select the operating mode.

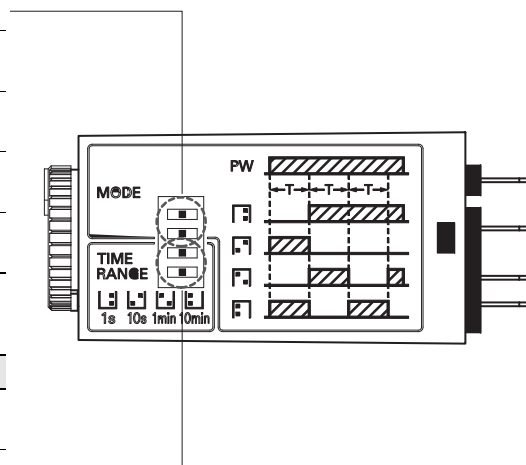

Timing Chart

Operating mode	Timing chart	
	H3YN-2-B/-21-B	H3YN-4-B/-41-B
<p>ON-delay</p>		
<p>Interval</p>		
<p>Flicker OFF-start</p>		
<p>Flicker ON-start</p>		

Note: t: Set time
Rt: Reset time

Precautions for H3Y-series Timers

Flush Mounting Adaptor

Y92F-78

(Excluding the H3Y-□-B and H3YN-□-B)

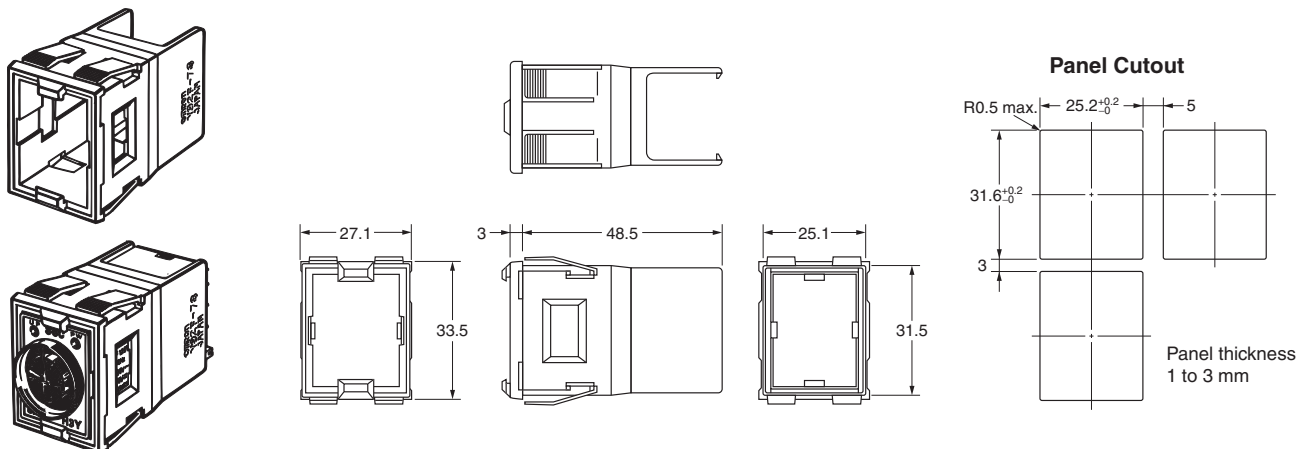

- Note:** 1. Push the H3Y in until the Adaptor (Y92F-78) hooks engage with its rear panel.
 2. Do not round the corners of the cutout on the rear panel surface, otherwise the Adaptor (Y92F-78) tabs may not engage properly.

Mounting Height

PYFZ-08(-E)/PYF08A-N
(PYFZ-14(-E)/PYF14A-N *1)

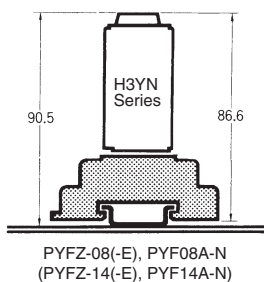

PY08 (PY14 *1)

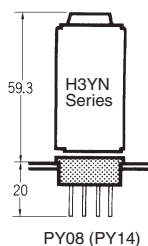

PY08QN (PY14QN *1)

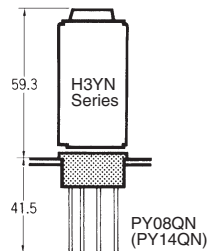

PYF-08-PU-L (PYF-14-PU-L *2)

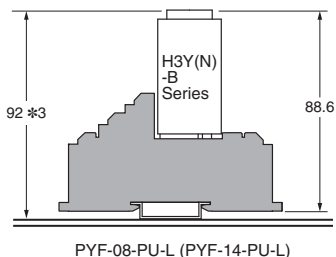

- Note:** 1. There are no restrictions to the mounting direction.
 2. Always use the PYF-□-PU-L with the H3Y-□-B or H3YN-□-B.
 *1. Models in parentheses are Connecting Sockets to the H3Y-4, H3YN-4/-41, or H3YN-4-Z/-41-Z.
 *2. Models in parentheses are Connecting Sockets to the H3Y-4-B, H3YN-4-B/-41-B, or H3YN-4-Z-B/-41-Z-B.
 *3. These values apply when the PFP-□N is used.
 Add 9 mm if you use the PFP-□N2.

Connecting Sockets (Order Separately)

H3Y/H3YN Series

Use one of the following Connecting Sockets: PYFZ-□(-E), PYF□A(-E), PYF□M, PY□, PY□-02, or PY□QN(2)(-Y3).
 (□: 08 or 14)

H3Y-□-B/H3YN-□-B Series

Use one of the following Connecting Sockets: PYF-□-PU-L.
 (□: 08 or 14)

H3Y Series

Accessories (Order Separately)

Use the PYFZ-□(-E), PYF□A(-E), PYF□M, PY□, PY□-02, or PY□QN(2) to mount the H3Y/H3YN.

Use the PYF-□-PU-L to mount the H3Y-□-B/H3YN-□-B.

When ordering any one of these sockets, replace "□" with "08" or "14."

Socket Mounting Plates (t = 1.6)

(Excluding the H3Y-□-B and H3YN-□-B)

Use a Socket Mounting Plate to mount multiple Connecting Sockets in a row.

Applicable socket	For mounting 1 socket	For mounting 18 sockets
PY08, PY14, PY08QN(2), PY14QN(2)	PYP-1	PYP-18

Note: PYP-18 may be cut to any desired length.

PYP-1

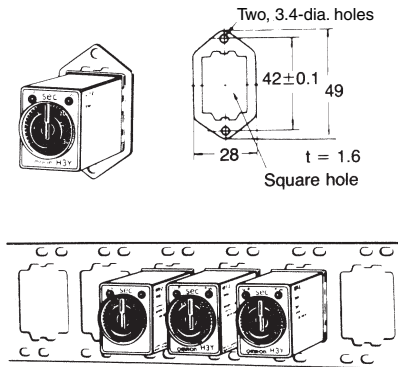

PYP-18

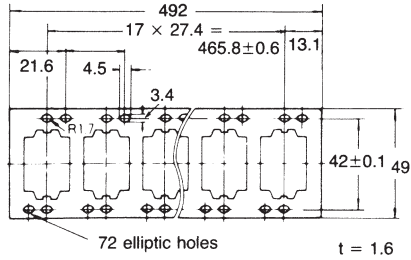

Terminal covers

PYCZ-C08

PYCZ-C14

Use these covers in a combination with PYFZ-08 and PYFZ-14.

H3Y/H3YN Series for PYFZ-08

PYCZ-C08

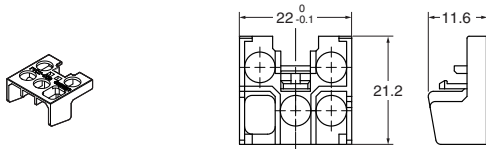

H3Y/H3YN Series for PYFZ-14

PYCZ-C14

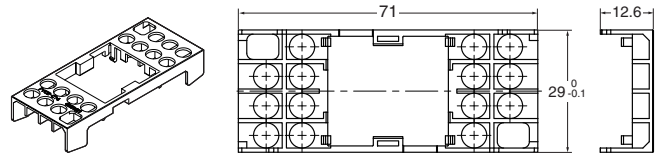

Dimensions with terminal cover

(Unit: mm)

PYCZ-C08

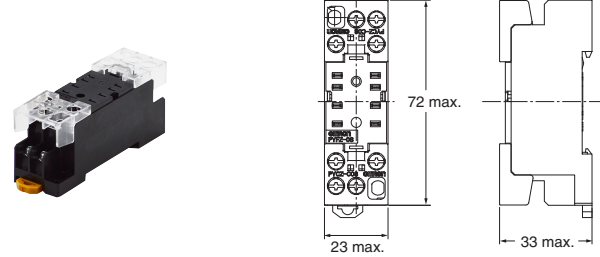

PYCZ-C14

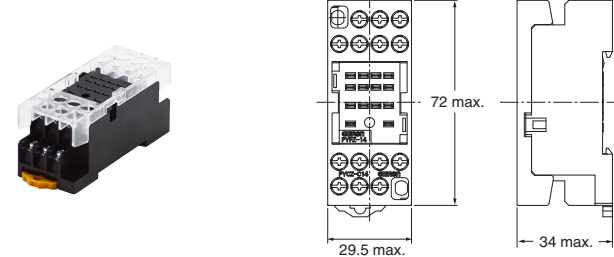

Relay Hold-down Clips

The Hold-down Clip makes it possible to mount the H3YN securely and prevent the H3YN from falling out due to vibration or shock.

Note: When you attach the Hold-down Clip to or remove it from the Socket, take sufficient precautions to not injury your fingers, such as wearing gloves.

Y92H-3

Y92H-4

H3Y/H3YN Series
for PYFZ-□, PYF□A Socket

Y92H-3

(Set of Two Clips)



H3Y-□-B/H3YN-□-B Series
for PYF-□-PU-L Socket

Y92H-3

(Set of Two Clips)

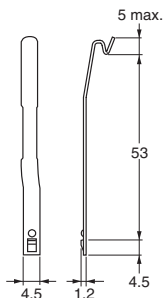

Y92H-4 for PY□, PYF□M Socket
(Excluding the H3Y-□-B and H3YN-□-B)

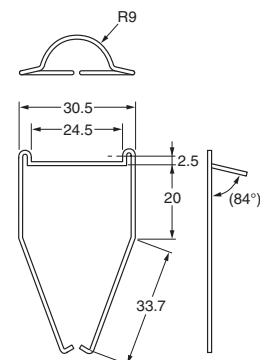

H3Y Series

H3Y/H3YN Series

Track Mounting/Front Connecting Sockets

PYFZ-08

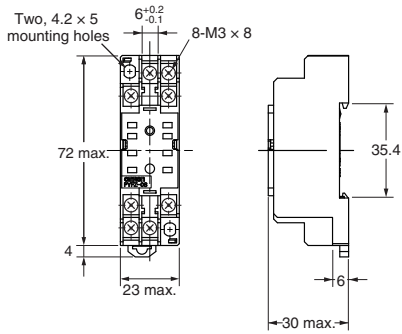

Terminal Arrangement/Internal Connection Diagram (Top View)

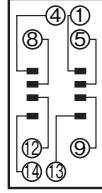

Mounting Hole Dimensions (Top View)

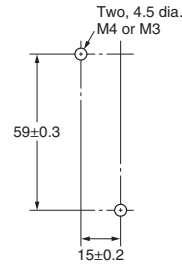

Note: Track mounting is also possible.

PYFZ-14

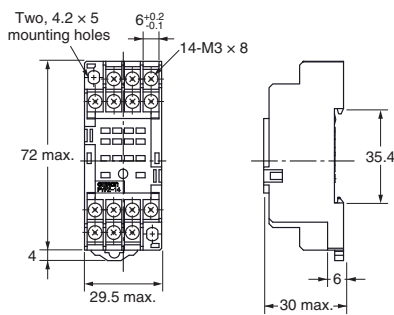

Terminal Arrangement/Internal Connection Diagram (Top View)

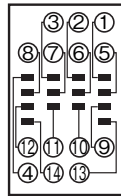

Mounting Hole Dimensions (Top View)

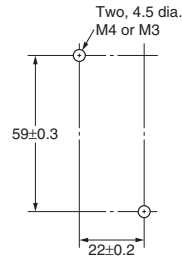

Note: Track mounting is also possible.

PYFZ-08-E (Finger-protection structure)

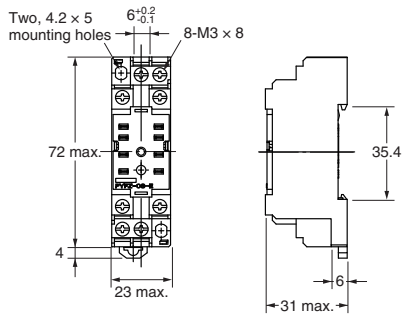

Terminal Arrangement/Internal Connection Diagram (Top View)

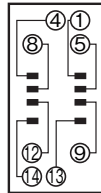

Mounting Hole Dimensions (Top View)

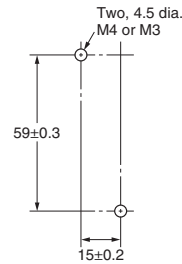

Note: Track mounting is also possible.

PYFZ-14-E (Finger-protection structure)

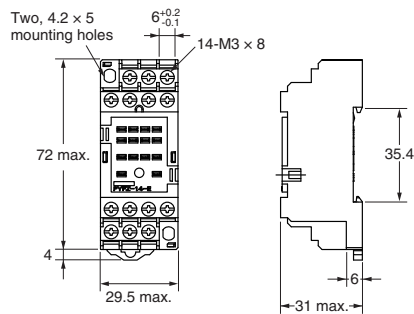

Terminal Arrangement/Internal Connection Diagram (Top View)

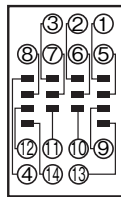

Mounting Hole Dimensions (Top View)

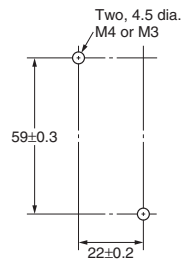

Note: Track mounting is also possible.

PYF08A-N

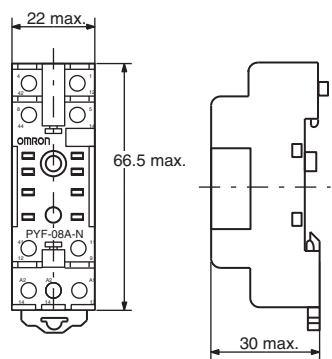

Terminal Arrangement

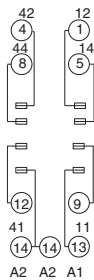

Mounting Holes (for Surface Mounting)

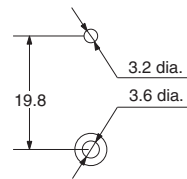

PYF14A-N

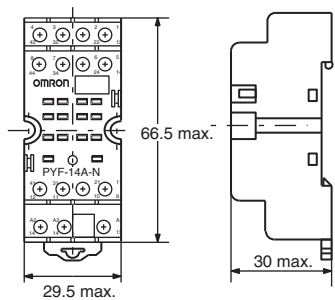

Terminal Arrangement

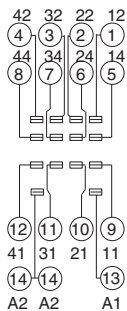

Mounting Holes (for Surface Mounting)

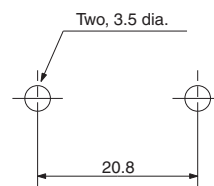

H3Y Series

H3Y/H3YN Series Back Connecting Sockets

PY08, PY14

Eight, 3 × 1.2 dia. holes
only for PY08 (Fourteen,
3 × 1.2 dia. holes)

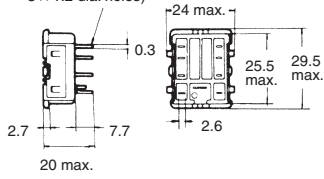

Terminal Arrangement (Bottom View)

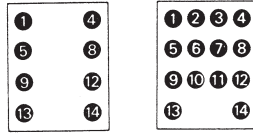

PY08

PY14

Panel Cutout

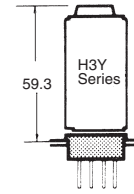
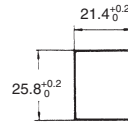

PY□, PY□-02,
PY□QN(2)

PY08QN, PY14QN PY08QN(2), PY14QN(2)

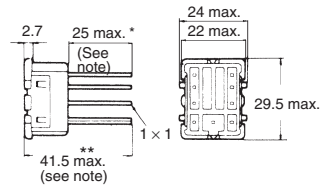

Terminal Arrangement (Bottom View)

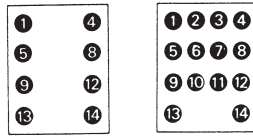

PY08QN
PY08QN(2)

PY14QN
PY14QN(2)

Note: With PY□QN(2), dimension * should read
20 max. and dimension ** 36.5 max.

PY08-02, PY14-02

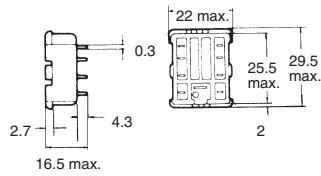

Terminal Arrangement (Bottom View)

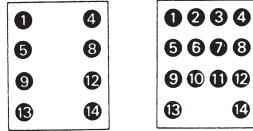

PY08-02

PY14-02

H3Y-□-B/H3YN-□-B Series Front Connecting Sockets

PYF-08-PU-L

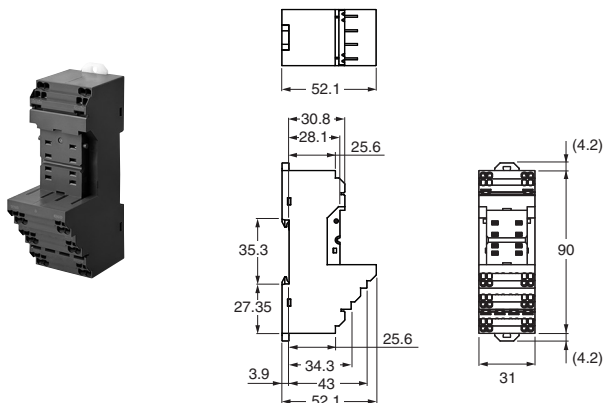

Terminal Arrangement/ Internal Connection Diagram (TOP VIEW)

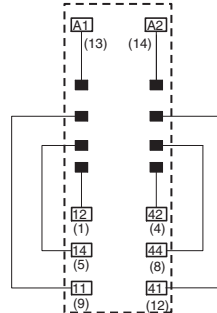

Mounting Hole Dimensions

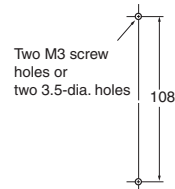

Note: The numbers in parentheses are traditionally used terminal numbers.

Note: Pull out the hooks to mount the Socket with screws.

PYF-14-PU-L

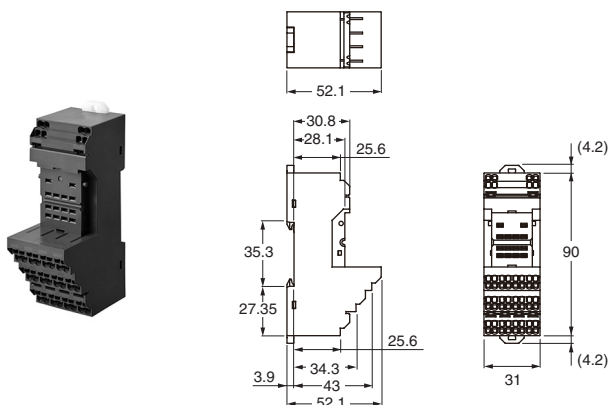

Terminal Arrangement/ Internal Connection Diagram (TOP VIEW)

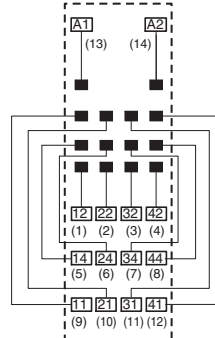

Mounting Hole Dimensions

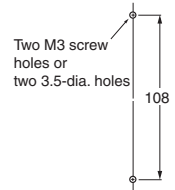

Note: The numbers in parentheses are traditionally used terminal numbers.

Note: Pull out the hooks to mount the Socket with screws.

Mounting Track

PFP-100N/PFP-50N (see note 1)

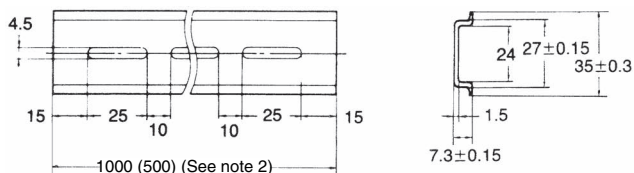

Note: 1. Meets DIN EN50022
2. This dimension applies to PFP-50N.

Spacer

PFP-S

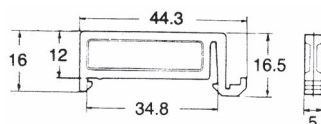

End Plate

PFP-M

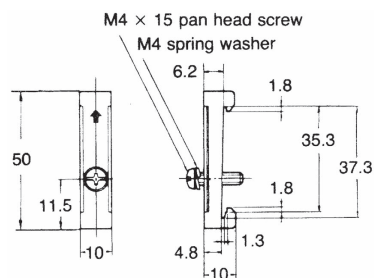



Safety Precautions

Be sure to read precautions for all models in the website at the following URL: <http://www.ia.omron.com/>.

Warning Indications

 CAUTION	Indicates a potentially hazardous situation which, if not avoided, may result in minor or moderate injury or in property damage.
Precautions for Safe Use	Supplementary comments on what to do or avoid doing, to use the product safely.
Precautions for Correct Use	Supplementary comments on what to do or avoid doing, to prevent failure to operate, malfunction or undesirable effect on product performance.

Meaning of Product Safety Symbols

	Used for general prohibitions for which there is no specific symbol.
	Use to indicate prohibitions when there is a risk of minor injury from electrical shock or other source if the product is disassembled.
	Used for general mandatory action precautions for which there is no specified symbol.

CAUTION

Risk of fire and explosion due to arcing and relay heat generation that accompanies switching. Do not use in an environment where flammable or explosive gas is present. 

The service life of the output relay varies widely depending on switching capacity and switching conditions. Use only within the rated load and electrical life count, based on actual conditions of use. Risk of contact sticking and burning if used past the service life. Always use a load current that does not exceed the rating, and if a heater is used, use a thermal switch in the load circuit. 

Do not remove the outer casing. 

In rare circumstances there is a risk of slight electrical shock, fire, or device damage. Do not disassemble, modify, repair, or otherwise touch the inside. 

Tighten the screws for the lead wires to the Socket to the following torque.
PYF Socket: 0.78 to 1.18 N·m
This is the recommended range when crimp terminals are used. 

If the screws are not tightened sufficiently on Front-connecting Sockets, the lead wires may come off, connection failure may cause abnormal heating, or fires may occur.
If they are tightened excessively, the screw threads may be damaged.

Precautions for Safe Use

Confirm that the setting dial, indicators and plastic parts are operating normally. Depending on the operating environment, the setting dial, indicators and plastic parts may deteriorate faster than expected, causing the indicators to fail. Periodically perform inspections and replacements.
We recommend that you use a surge absorber if surge voltages may occur.
When you dispose of the Timer, do so according to all local ordinances for processing industrial waste.

Precautions for Correct Use

- When selecting a control output, use the H3Y-2/H3YN-2/H3Y-2-B/H3YN-2-B for switching ON and OFF the power and the H3Y-4/H3YN-4/H3Y-4-B/H3YN-4-B for switching ON and OFF the minute load. Gold-plated relays are used in the H3Y-4, H3YN-4, H3Y-4-B, H3YN-4-B, H3YN-4-Z, H3YN-41-Z, H3YN-4-Z-B, and H3YN-41-Z-B Series.
- Connect the power supply between terminals A1 (13) and A2 (14). For a DC power supply, connect the negative side to A1 (13) and the positive side to A2 (14).
- The operating voltage will increase when using the H3Y/H3YN/H3Y-B/H3YN-B in any place where the ambient temperature is more than 50°C. Supply 90% to 110% of the rated voltages (at 12 VDC: 95% to 110%) when operating at 45°C or higher.
- Do not leave the H3Y/H3YN/H3Y-B/H3YN-B in time-up condition for a long period of time (for example, more than one month in any place where the ambient temperature is high), otherwise the internal parts (aluminum electrolytic capacitor) may become damaged. Therefore, the use of the H3Y/H3YN/H3Y-B/H3YN-B with a relay as shown in the following circuit diagram is recommended to extend the service life of the H3Y/H3YN/H3Y-B/H3YN-B.

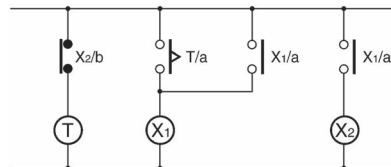

⊗: Auxiliary relay such as MY Relay

- The H3YN/H3YN-B must be disconnected from the Socket when setting the DIP switch, otherwise the user may touch a terminal imposed with a high voltage and get an electric shock.
- Do not connect the H3Y/H3YN/H3Y-B/H3YN-B as shown in the following circuit diagram on the right hand side, otherwise the H3Y's/H3YN's/H3Y-B's/H3YN-B's internal contacts different from each other in polarity may become short-circuited.

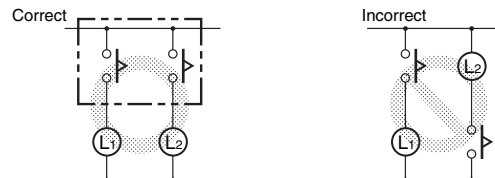

- Use the following safety circuit when building a self-holding or self-resetting circuit with the H3Y/H3YN/H3Y-B/H3YN-B and an auxiliary relay, such as an MY Relay, in combination.

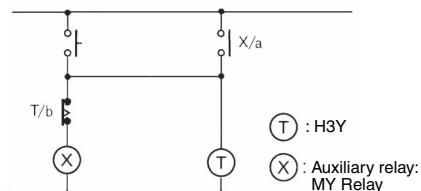

- In the case of the above circuit, the H3YN will be in pulse operation. Therefore, if the circuit shown on page 13 is used, no auxiliary relay will be required.
- Do not set to the minimum setting in the flicker modes, otherwise the contact may become damaged.
- Be careful not to apply any voltage to the terminal screws on the back of the Timer. Mount the product so that the screws will not come in contact with the panel or metal parts.
- Do not use the H3Y/H3YN/H3Y-B/H3YN-B in places where there is excessive dust, corrosive gas, or direct sunlight.
- Do not mount more than one H3Y/H3YN/H3Y-B/H3YN-B closely together, otherwise the internal parts may become damaged. Make sure that there is a space of 5 mm or more between any H3Y/H3YN/H3Y-B/H3YN-B Models next to each other to allow heat radiation.
- The internal parts may become damaged if a supply voltage other than the rated ones is imposed on the H3Y/H3YN/H3Y-B/H3YN-B. When more than 100 V is applied to 12 or 24 VDC models, the internal element (varistor) may break.
- In order to conform to UL and CSA requirements when using the H3Y-4/-4-0/-4-B, H3YN-4/-41/-4-B/-41-B, or H3YN-4-Z/-41-Z/-4-Z-B/-41-ZB, connect the Unit so that output contacts (contacts of different poles) have the same electric potential.
- In cases such as PLC input where the load is extremely small for the control output of a timer containing a power relay (using other than gold-plated contacts), reliability can be increased by using contacts of the same poles (e.g., the H3Y-2) in parallel.
- Always use the same type of wire.
- Installation
There are no restrictions on the installation orientation. Install the Timer securely.

Precautions for EN 61812-1 Conformance

The H3Y/H3YN/H3Y-B/H3YN-B as a built-in timer conforms to EN 61812-1 provided that the following conditions are satisfied.

Handling

- Do not touch the DIP switch while power is supplied to the H3YN/H3YN-B.
- Before dismantling the H3YN/H3YN-B from the Socket, make sure that no voltage is imposed on any terminal of the H3YN/H3YN-B.
- The applicable Socket is the PYF□A (H3Y/H3YN) or PYF-□-PU-L (H3Y-B/H3YN-B).
- Only basic insulation is ensured between the Y92H-3 Hold-down Clips and H3Y/H3YN/H3Y-B/H3YN-B internal circuits.
- Do not allow the Y92H-3 Hold-down Clips to contact other parts.
- The insulation test voltage between different pole contacts for the 4-pole model is the impulse voltage of 2.95 kV.

Wiring

- The power supply for the H3Y/H3YN/H3Y-B/H3YN-B must be protected with equipment such as a breaker approved by VDE.
- Basic insulation is ensured between the H3Y's/H3YN's/H3Y-B's/H3YN-B's operating circuit and control output.
- Insulation requirement:
Overvoltage category II,
pollution degree 1 (H3Y-4/-4-0/-4-B, H3YN-4/41/-4-B/-41-B,
H3YN-4-Z/-41-Z/-4-Z-B/-41-Z-B),
pollution degree 2 (H3Y-2/-2-0/-2-B, H3YN-2/21/-2-B/-21-B)
(with a clearance of 1.5 mm and a creepage distance of 2.5 mm at 240 VAC)
- Output terminals next to each other on the H3Y-4 or H3Y-4-0 must have the same polarity.

Recommended Replacement Periods and Periodic Replacement as Preventive Maintenance

The recommended replacement period for preventive maintenance is greatly influenced by the application environment of the product. As a guideline for models that do not have a Maintenance Forecast Monitor, the recommended replacement period is 7 to 10 years.* To prevent failures that can be caused by using a product beyond its service life, we recommend that you replace the product as early as possible within the recommended replacement period. However, realize that the recommended replacement period is for reference only and does not guarantee the life of the product.

Many electronic components are used in the product and the product depends on the correct operation of these components to achieve product functions and performance. However, the influence of the ambient temperature on aluminum electrolytic capacitors is large, and the service life is reduced by half for each 10°C rise in temperature (Arrhenius law). When the capacity reduction life of the electrolytic capacitor is reached, the product may fail. We therefore recommend that you replace the product periodically to minimize product failures in advance.

* The following conditions apply: rated input voltage, load rate of 50% max., ambient temperature of 35°C max., and the standalone mounting method.

This product model is designed with a service life of 10 years minimum under the above conditions.

Terms and Conditions Agreement

Read and understand this catalog.

Please read and understand this catalog before purchasing the products. Please consult your OMRON representative if you have any questions or comments.

Warranties.

- (a) Exclusive Warranty. Omron's exclusive warranty is that the Products will be free from defects in materials and workmanship for a period of twelve months from the date of sale by Omron (or such other period expressed in writing by Omron). Omron disclaims all other warranties, express or implied.
- (b) Limitations. OMRON MAKES NO WARRANTY OR REPRESENTATION, EXPRESS OR IMPLIED, ABOUT NON-INFRINGEMENT, MERCHANTABILITY OR FITNESS FOR A PARTICULAR PURPOSE OF THE PRODUCTS. BUYER ACKNOWLEDGES THAT IT ALONE HAS DETERMINED THAT THE PRODUCTS WILL SUITABLY MEET THE REQUIREMENTS OF THEIR INTENDED USE.

Omron further disclaims all warranties and responsibility of any type for claims or expenses based on infringement by the Products or otherwise of any intellectual property right. (c) Buyer Remedy. Omron's sole obligation hereunder shall be, at Omron's election, to (i) replace (in the form originally shipped with Buyer responsible for labor charges for removal or replacement thereof) the non-complying Product, (ii) repair the non-complying Product, or (iii) repay or credit Buyer an amount equal to the purchase price of the non-complying Product; provided that in no event shall Omron be responsible for warranty, repair, indemnity or any other claims or expenses regarding the Products unless Omron's analysis confirms that the Products were properly handled, stored, installed and maintained and not subject to contamination, abuse, misuse or inappropriate modification. Return of any Products by Buyer must be approved in writing by Omron before shipment. Omron Companies shall not be liable for the suitability or unsuitability or the results from the use of Products in combination with any electrical or electronic components, circuits, system assemblies or any other materials or substances or environments. Any advice, recommendations or information given orally or in writing, are not to be construed as an amendment or addition to the above warranty.

See <http://www.omron.com/global/> or contact your Omron representative for published information.

Limitation on Liability; Etc.

OMRON COMPANIES SHALL NOT BE LIABLE FOR SPECIAL, INDIRECT, INCIDENTAL, OR CONSEQUENTIAL DAMAGES, LOSS OF PROFITS OR PRODUCTION OR COMMERCIAL LOSS IN ANY WAY CONNECTED WITH THE PRODUCTS, WHETHER SUCH CLAIM IS BASED IN CONTRACT, WARRANTY, NEGLIGENCE OR STRICT LIABILITY.

Further, in no event shall liability of Omron Companies exceed the individual price of the Product on which liability is asserted.

Suitability of Use.

Omron Companies shall not be responsible for conformity with any standards, codes or regulations which apply to the combination of the Product in the Buyer's application or use of the Product. At Buyer's request, Omron will provide applicable third party certification documents identifying ratings and limitations of use which apply to the Product. This information by itself is not sufficient for a complete determination of the suitability of the Product in combination with the end product, machine, system, or other application or use. Buyer shall be solely responsible for determining appropriateness of the particular Product with respect to Buyer's application, product or system. Buyer shall take application responsibility in all cases.

NEVER USE THE PRODUCT FOR AN APPLICATION INVOLVING SERIOUS RISK TO LIFE OR PROPERTY OR IN LARGE QUANTITIES WITHOUT ENSURING THAT THE SYSTEM AS A WHOLE HAS BEEN DESIGNED TO ADDRESS THE RISKS, AND THAT THE OMRON PRODUCT(S) IS PROPERLY RATED AND INSTALLED FOR THE INTENDED USE WITHIN THE OVERALL EQUIPMENT OR SYSTEM.

Programmable Products.

Omron Companies shall not be responsible for the user's programming of a programmable Product, or any consequence thereof.

Performance Data.

Data presented in Omron Company websites, catalogs and other materials is provided as a guide for the user in determining suitability and does not constitute a warranty. It may represent the result of Omron's test conditions, and the user must correlate it to actual application requirements. Actual performance is subject to the Omron's Warranty and Limitations of Liability.

Change in Specifications.

Product specifications and accessories may be changed at any time based on improvements and other reasons. It is our practice to change part numbers when published ratings or features are changed, or when significant construction changes are made. However, some specifications of the Product may be changed without any notice. When in doubt, special part numbers may be assigned to fix or establish key specifications for your application. Please consult with your Omron's representative at any time to confirm actual specifications of purchased Product.

Errors and Omissions.

Information presented by Omron Companies has been checked and is believed to be accurate; however, no responsibility is assumed for clerical, typographical or proofreading errors or omissions.

OMRON Corporation Industrial Automation Company

Kyoto, JAPAN

Contact: www.ia.omron.com

Regional Headquarters

OMRON EUROPE B.V.

Wegalaan 67-69, 2132 JD Hoofddorp
The Netherlands
Tel: (31)2356-81-300/Fax: (31)2356-81-388

OMRON ELECTRONICS LLC

2895 Greenspoint Parkway, Suite 200
Hoffman Estates, IL 60169 U.S.A.
Tel: (1) 847-843-7900/Fax: (1) 847-843-7787

OMRON ASIA PACIFIC PTE. LTD.

No. 438A Alexandra Road # 05-05/08 (Lobby 2),
Alexandra Technopark,
Singapore 119967
Tel: (65) 6835-3011/Fax: (65) 6835-2711

OMRON (CHINA) CO., LTD.

Room 2211, Bank of China Tower,
200 Yin Cheng Zhong Road,
PuDong New Area, Shanghai, 200120, China
Tel: (86) 21-5037-2222/Fax: (86) 21-5037-2200

Authorized Distributor:

© OMRON Corporation 2016-2021 All Rights Reserved.
In the interest of product improvement,
specifications are subject to change without notice.

CSM_2_2
Cat. No. M092-E1-05

0421 (0316)

X-ON Electronics

Largest Supplier of Electrical and Electronic Components

Click to view similar products for [Timers](#) category:

Click to view products by [Omron](#) manufacturer:

Other Similar products are found below :

[79237785](#) [H5AN-4DM DC12-24](#) [H5CN-YAN AC100-240](#) [H5CX-L8S-N AC100-240](#) [H5S-WFB2D](#) [H5AN-4D DC12-24](#) [THR2U-110A](#)
[81506944](#) [88225029](#) [H5S-YB4-X](#) [H5CN-XANS DC12-48](#) [H7AN-W4DM DC12-24](#) [H7AN-4DM DC12-24](#) [H7AN-4D DC12-24](#) [H7AN-](#)
[RT6M AC100-240](#) [1SVR508020R1100](#) [1SVR508100R0000](#) [1SVR550127R4100](#) [1SVR730010R3200](#) [1SVR730020R3300](#)
[1SVR730211R2300](#) [1SVR740100R3300](#) [PCU-511UNI](#) [H3C-R](#) [H3CR-A8-301 24-48AC/12-48DC](#) [H3CR-A8E 24-48AC/DC](#) [H3CR-F8 100-](#)
[240AC/100-125DC](#) [H3CR-FN 100-240AC/100-125DC](#) [H3DK-G 24-230AC/DC](#) [H3DK-HBL AC/DC24-48](#) [H3DK-M1A DC12](#) [H3DT-A1 24-](#)
[240AC/DC](#) [LT4H-AC24V](#) [LT4HW8-AC240V](#) [LT4HW-AC240V](#) [LT4HW-AC240VS](#) [LT4HW-AC24VS](#) [LT4HW-DC24V](#) [LT4HW-DC24VS](#)
[31L48AP](#) [31L48TPM240](#) [RC302](#) [RC312](#) [RE48ACV12MW](#) [REV-201M](#) [RG](#) [AT78041](#) [AT78051](#) [ATC180041](#) [TMM1](#)