

1/16 DIN, Quartz Timer with Four-Digit LED Display

- Five wide ranges to choose from
- Wide-range AC or DC supply voltages
- Elapsed time (UP) or time remaining (DOWN) display available
- Selectable no-voltage reset and gate inputs expand capabilities
- Memory protection circuit available on AC models; order back-up battery separately from accessories
- Easy-to-read 8 mm-high LED display
- Panel mounting adapter, sockets, and accessories may be ordered separately



Ordering Information

■ TIMERS

NOTE: The complete part numbers shown here are the only H5CN timers currently available. Some time ranges and supply voltages have been discontinued.

Timing functions	ON-delay				
Contact type	SPDT relay			Solid-state open collector	
Display type	Elapsed time (UP)		Time remaining (DOWN)	Elapsed time (UP)	
Memory protection	Not provided	Provided	Not provided	Not provided	
Terminal form	8-pin round socket	11-pin round socket	8-pin round socket	8-pin round socket	
Part number	0.001 to 9.999 sec	—	—	—	H5CN-XZNS-AC100-240 H5CN-XZNS-DC12-48
	0.01 to 99.9 sec	H5CN-XAN-AC24 H5CN-XAN-AC100-240 H5CN-XAN-DC12-48	— H5CN-XANM-AC100-240 —	— H5CN-YAN-AC100-240 H5CN-YAN-DC12-48	— H5CN-XANS-AC100-240 H5CN-XANS-DC12-48
	0.1 to 999.9 sec	H5CN-XBN-AC24 H5CN-XBN-AC100-240 H5CN-XBN-DC12-48	— H5CN-XBNM-AC100-240 H5CN-XBNM-DC12-48	— H5CN-YBN-AC100-240 H5CN-YBN-DC12-48	— — —
	1 s to 99 min 59 s	H5CN-XCN-AC24 H5CN-XCN-AC100-240 H5CN-XCN-DC12-48	— H5CN-XCNM-AC100-240 —	— H5CN-YCN-AC24 H5CN-YCN-AC100-240 H5CN-YCN-DC12-48	— — —
	1 min to 99 h 59 min	H5CN-XDN-AC24 H5CN-XDN-AC100-240 H5CN-XDN-DC12-48	— H5CN-XDNM-AC100-240 —	— H5CN-YDN-AC100-240 H5CN-YDN-DC12-48	— — —

■ ACCESSORIES

Description		Part number	
Sockets	H5CN-□□N timers	Bottom surface or track mounting, top screw terminals	P2CF-08
		Back mounting, for use with Y92F-30 mounting adapter, bottom screw terminals.	P3G-08
	H5CN-□□□M timers	Bottom surface or track mounting, top screw terminals	P2CF-11
		Back mounting, for use with Y92F-30 mounting adapter, bottom screw terminals	P3GA-11
Panel mounting adapter		Fits behind panel, ideal for side by side installation. Use P3G□-□□ sockets.	Y92F-30
Battery for memory backup		Use with H5CN-□□□M timers.	Y92S-20
Protective cover		Hard plastic cover	Y92A-48B
		Soft plastic cover; allows settings to be changed through the cover.	Y92A-48D
Mounting track		DIN rail, 50 cm (1.64 ft) length	PFP-50N
		DIN rail, 1 m (3.28 ft) length	PFP-100N
		End plate	PFP-M
		Spacer	PFP-S

Specifications

Part number		H5CN-X□N	H5CN-X□NM	H5CN-Y□N	H5CN-X□NS
Supply voltage	AC	24 V, 100 to 240 V; 50/60 Hz			100 to 240 V; 50/60 Hz
	DC	12 to 48 V (permissible ripple factor; 20% max.)			
Operating voltage		85 to 110% of the rated voltage			
Power consumption	AC	12 VA at 240 VAC, 50/60 Hz			—
	DC	2.5 W at 48 VDC			2.5 W at 48 VDC
Timing functions		ON-delay with elapsed time display	ON-delay with time remaining display	ON-delay with elapsed time display	
Reset, gate inputs		No voltage			
Control output	Type	Time limit	SPDT relay		Open collector solid-state
		Instantaneous	—		—
	Max. load	3 A, 250 VAC (p.f. = 1)			100 mA max. 30 VDC
	Min. load	10 mA, 5 VDC			
Repeat accuracy		±0.01% ±0.05 sec max. (power-ON start); ±0.005% ±0.03 sec max. (reset start)			
Setting error		See "Repeat accuracy"			
Resetting system		Power-OFF and external reset			
Resetting time		Power OFF: 0.5 sec min.; External reset: 0.02 sec signal min.			
Indicators		Time UP (red LED), 8 mm LED numeric display			
Materials		Plastic			
Mounting		Panel, track, surface			
Connections		8-pin round socket	11-pin round socket	8-pin round socket	
Weight		150 g (5.31 oz.)			
Approvals		UL/CSA/SEV			
Operating ambient temperature		-10° to 55°C (14° to 131°F)			
Humidity		35 to 85% RH			
Vibration	Mechanical durability	10 to 55 Hz; 0.75 mm (0.03 in) double amplitude			
	Malfuction durability	10 to 55 Hz; 0.5 mm (0.02 in) double amplitude			
Shock	Mechanical durability	30 G			
	Malfuction durability	10 G			
Variation due to voltage change		See "Repeat Accuracy"			
Variation due to temperature change		See "Repeat Accuracy"			
Insulation resistance		100 MΩ min. at 500 VDC			
Dielectric strength		2,000 VAC, 50/60 Hz for 1 minute between current-carrying terminal and exposed non-current-carrying metal parts, between power supply circuit, and control output circuit			
Service life	Mechanical	10 million operations minimum			Not applicable
	Electrical	100,000 operations minimum at maximum ratings			Not applicable

Engineering Data

■ ELECTRICAL SERVICE LIFE

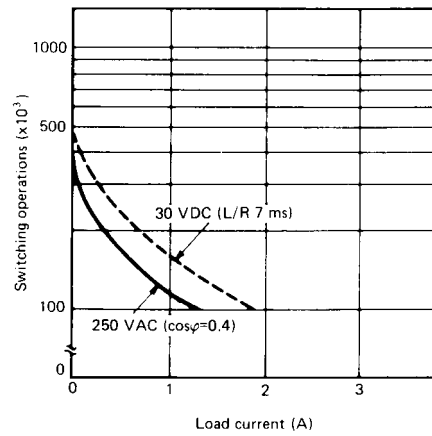
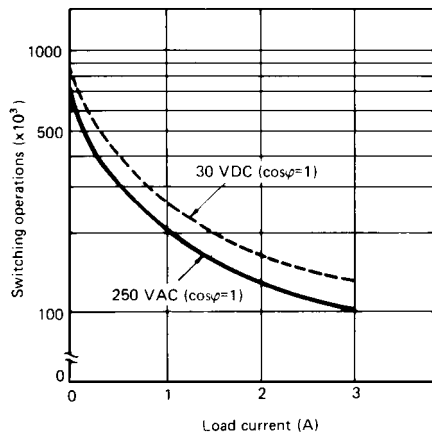

Note: The service life graphs apply to all relay output models. They do not apply to solid-state output models H5CN-XZNS or H5CN-XANS.

Timing Charts

■ ELAPSED TIME (UP) DISPLAY

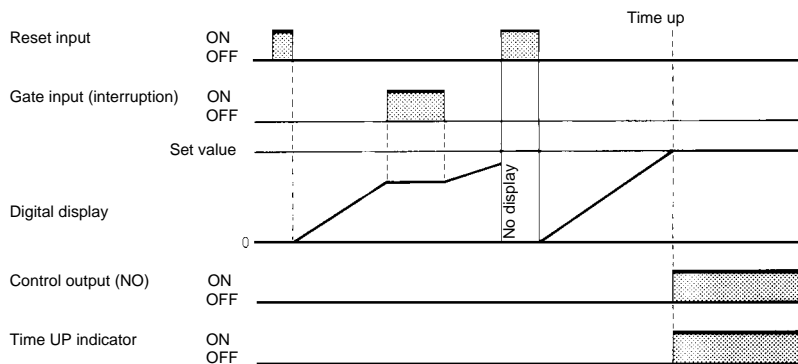

■ TIME REMAINING (DOWN) DISPLAY

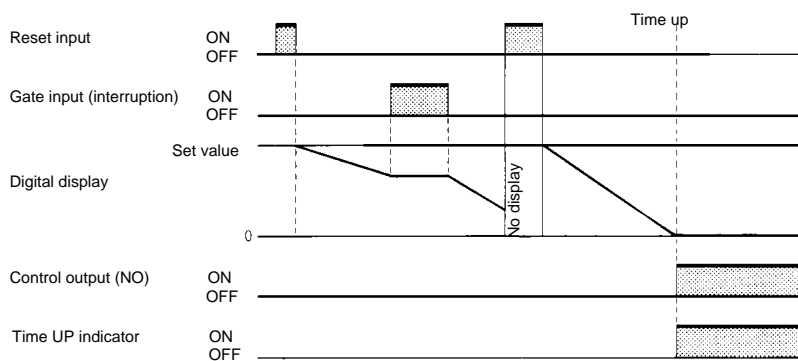

Dimensions

Unit: mm (inch)

TIMERS

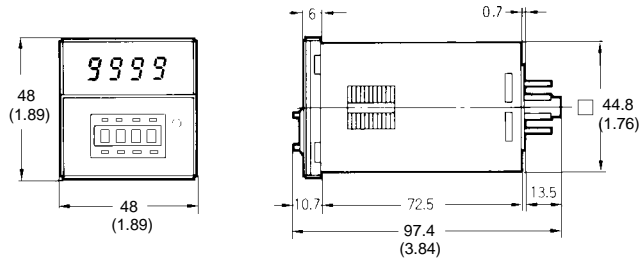
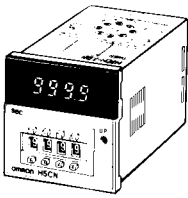

Panel cutout

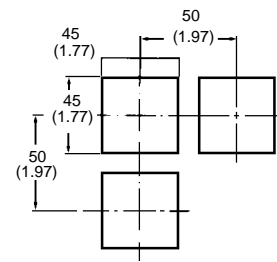

Note: Recommended panel thickness is 1 to 3.2 mm.

Panel cutout conforms to DIN 43700.

SOCKETS

8-Pin Sockets for H5CN-X□N, H5CN-Y□N and H5CN-X□NS

P2CF-08 Bottom Surface or Track Mounting

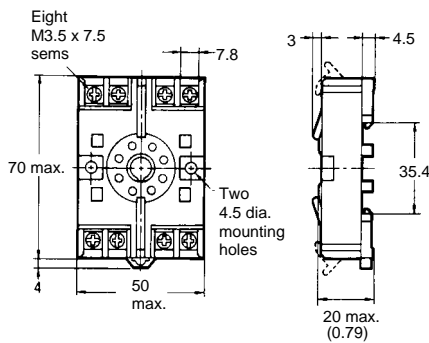
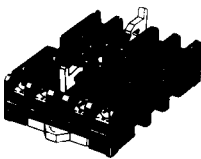

Terminal arrangement

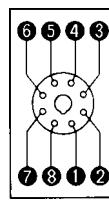

Mounting holes

Two 4.5 dia. or two M4 socket mounting holes

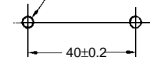

P3G-08 Back Mounting Socket

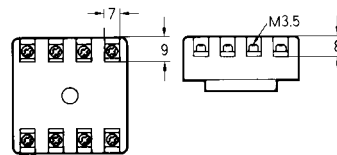
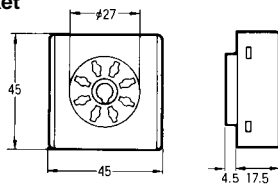

Terminal arrangement

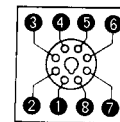

(Bottom view)

11-Pin Sockets for H5CN-X□NM

P2CF-11 Bottom Surface or Track Mounting Socket

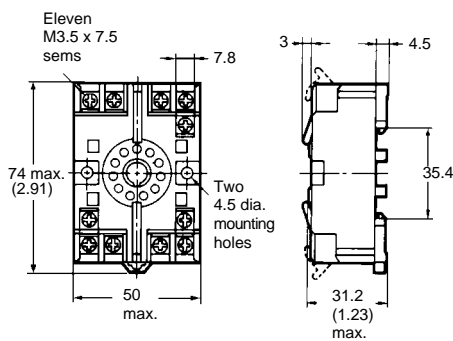
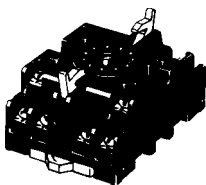

Terminal arrangement

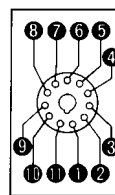

(Top view)

Mounting holes

Two 4.5 dia. socket mounting holes

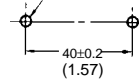

P3GA-11 Back Mounting Socket

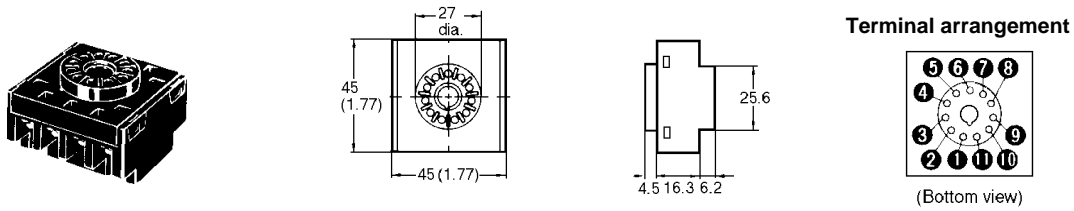

■ PANEL MOUNTING ADAPTER

Y92F-30 Mounting Adapter

Adapter installs behind the panel. It is ideal for side by side installation. Use P3GA-11 or P3G-08 sockets.

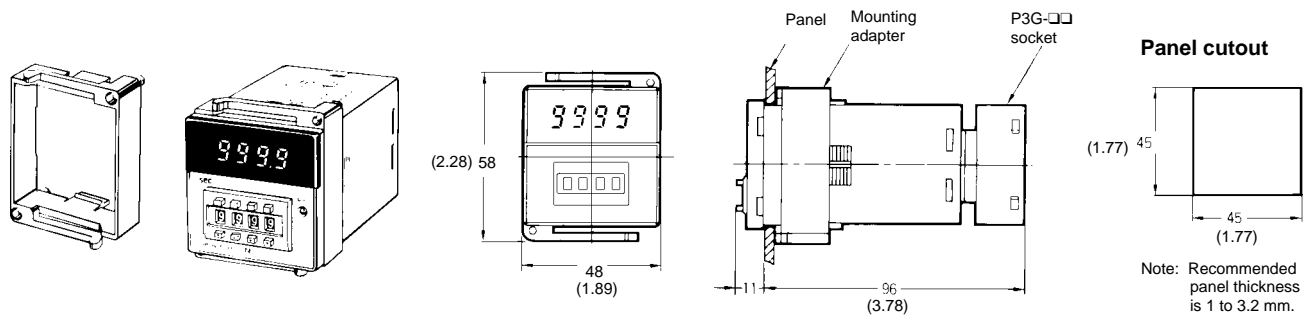

■ BATTERY FOR MEMORY BACK-UP

Y92S-20 Battery

Use this battery with H5CN-XN□M timers with memory protection circuit. While the timer's built-in memory protection circuit can retain values for power failures lasting up to 10 minutes, the optional battery protects memory in case of a longer power outage. We recommend using the battery as a safeguard. Memory values can be retained for up to 5 years.

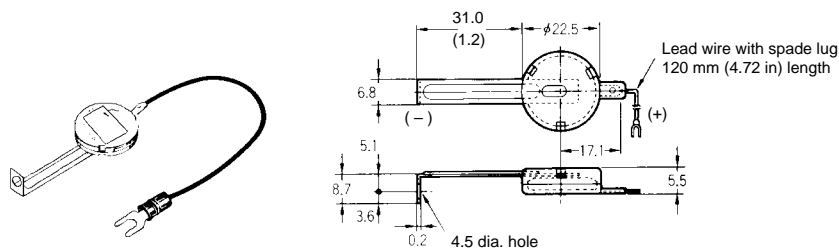

■ PROTECTIVE COVERS

Y92A-48B Hard Plastic Cover

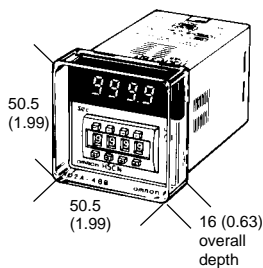

Y92A-48D Soft Plastic Cover

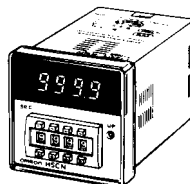

Hard plastic cover Y92A-48B and soft plastic cover Y92A-48D snap onto the front of the timer to protect against dirt and water. The Y92A-48B hard plastic cover prevents accidental resetting. Y92A-48D soft plastic cover fits snugly over the front and allows settings to be changed. These covers are intended for use in areas where unusual service conditions do not exist.

■ MOUNTING TRACK AND ACCESSORIES

PPF-100N/PPF-50N DIN Rail

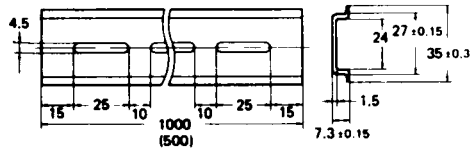

PPF-M End Plate

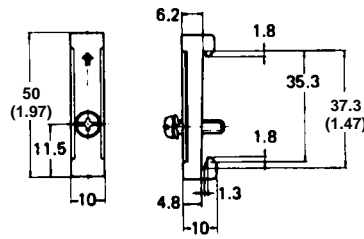

PPF-S Spacer

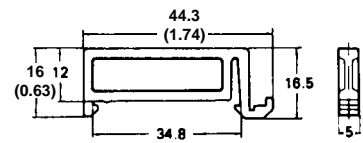

Connections

Part number	Input terminal number (no-voltage only)			Power supply terminal numbers		Output terminal numbers				
	COM	Gate	Reset	AC (common), DC-	AC (hot), DC+	COM	NC	NO	DC-	DC+
H5CN-□□□N	1	4	3	2	7	8	5	6	—	—
H5CN-□□□S	1	4	3	2	7	8	—	6	—	—
H5CN-□□□M	3	5	7	2	10	11	8	9	1	4

H5CN-□□□N Timer

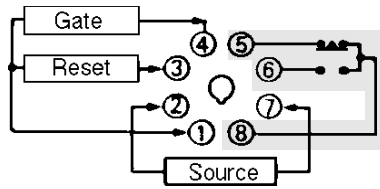

H5CN-□□□S Timer

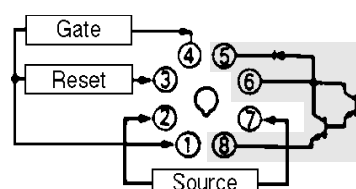

H5CN-□□□M Timer

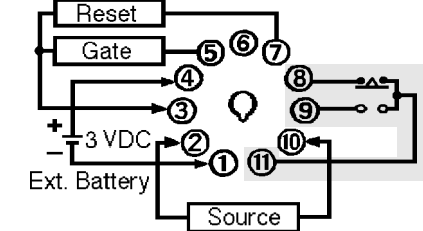

Note: Internal (isolated) contacts are shaded.

■ POWER SUPPLY

H5CN-□□□N and H5CN-□□□S Timers

Connect the timer so that the supply voltage is applied to terminals 2 and 7. This is for models without memory protection.

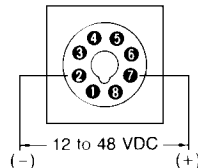
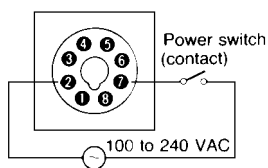

H5CN-□□□M Timers

For models with memory protection, connect the supply voltage to terminals 2 and 10.

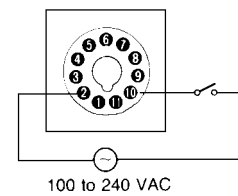

■ CONTROL OUTPUT

Timed contact output type H5CN-□□□N

Terminals 5, 6 and 8 are used for the output relay. A normally open contact (Load 1) is connected between terminals 6 and 8. A normally closed contact (Load 2) is connected between terminals 5 and 8.

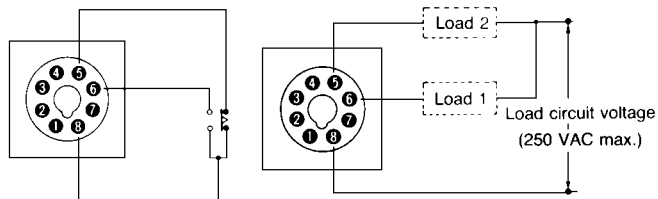

Timed Solid-state output type H5CN-X□NS

The solid-state output uses an open collector type transistor. Connect terminal 6 (collector) to the positive terminal of the load. Connect terminal 8 (emitter) to the negative terminal. A built-in surge suppression diode on terminal 5 should be connected to the positive terminal of the load when the timer switches an inductive load.

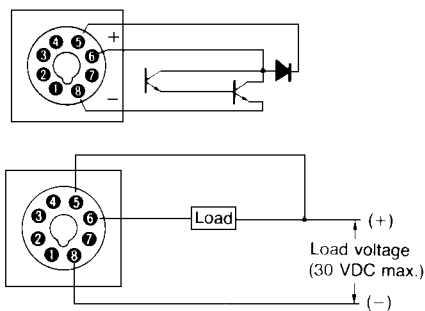

Timed contact output with memory protection H5CN-X□NM

Terminals 8, 9 and 11 are used for the output relay. A normally open contact (Load 1) is connected between terminals 9 and 11. A normally closed contact (Load 2) is connected between terminals 8 and 11.

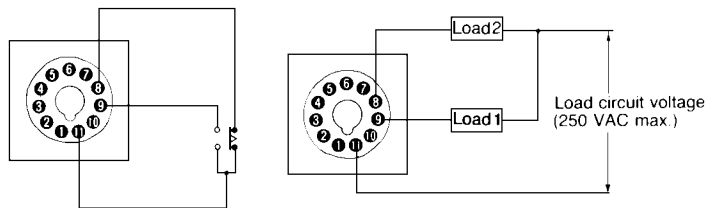

INPUT REQUIREMENTS

Contact

Resistance	1 KΩ max.
Residual voltage	1 V max. when the contact makes
Contact material	Gold-plated contacts

Note: Select a contact with short bounce time. Contact bounce causes an error in the operate time equal to bounce time.

Solid-State

Input type	Open collector transistor
Voltage when collector is OFF	20 V min.
Collector current	50 mA min.
Input current between collector and base	0.6 mA max.

RESET INPUT

Timers without memory protection H5CN-□□□□, H5CN-□□□□S

Connect a no-voltage contact or an open collector transistor output to terminals 1 and 3. The timer resets when contact is made or when the transistor turns ON.

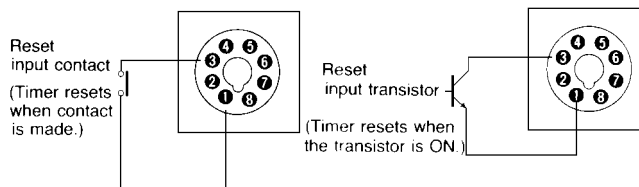

Timers with memory protection H5CN-X□NM

Connect a no-voltage contact or an open collector transistor output to terminals 3 and 7. The timer resets when contact is made or when the transistor turns ON.

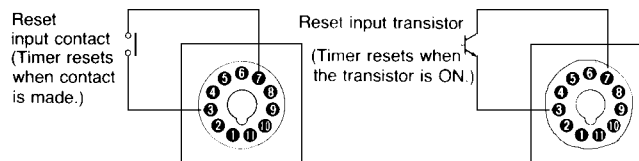

■ GATE INPUT

Cumulative Timing Using the Gate Input with ON-Delay

When the gate signal is closed, timing is temporarily stopped. When the gate signal opens, timing resumes at the point of interruption. The gate input terminal permits the timer to sum up times T_1 , T_2 and T_3 as shown in the timing chart.

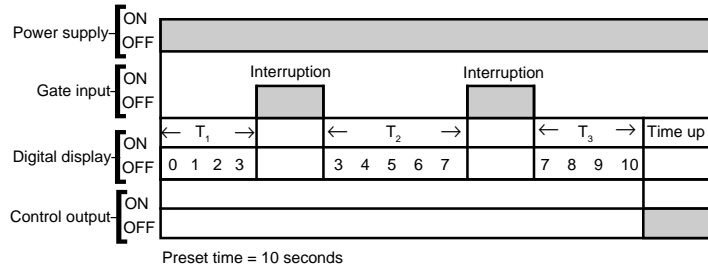

Timers without memory protection H5CN-□□□, H5CN-□□□S

Connect a no-voltage contact or an open collector transistor output to terminals 1 and 4. The gate input interrupts timing when the contact closes or when the transistor is ON. Timing resumes from the point of interruption when the gate input is removed.

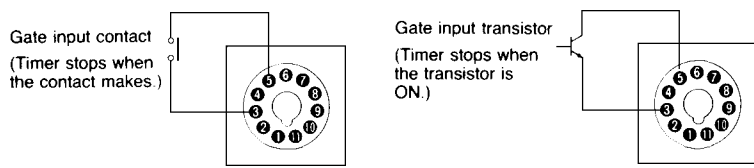

Timers with memory protection H5CN-□□□M

Connect a no-voltage contact or an open collector transistor output to terminals 3 and 5. The gate input interrupts timing when the contact closes or when the transistor is ON. Timing resumes from the point of interruption when the gate input is removed.

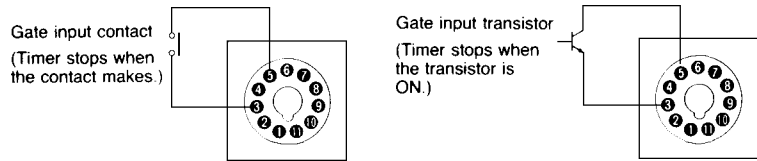

■ BATTERY FOR MEMORY PROTECTION

Connect the Y92S-20 battery between terminals 1 and 4 on H5CN-□□□M timers. The 3 V lithium battery is in a holder with lead wire and terminations. It may be used to preserve timer memory for power outages that are longer than 10 minutes duration. Because power failure duration is unpredictable, we recommend using Y92S-20 for long-term memory back up.

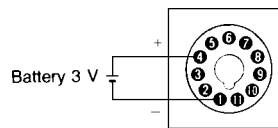

■ SIMULTANEOUS INPUT TO SEVERAL H5CN TIMERS

For expanded convenience, input signal may be used to apply gate and reset signals to several H5CN timers. Also a combination of gate to some and reset to other timers is possible. Timers with and without memory backup may be used together. Pay attention to the different terminal numbers required for gate and reset when mixing timer types.

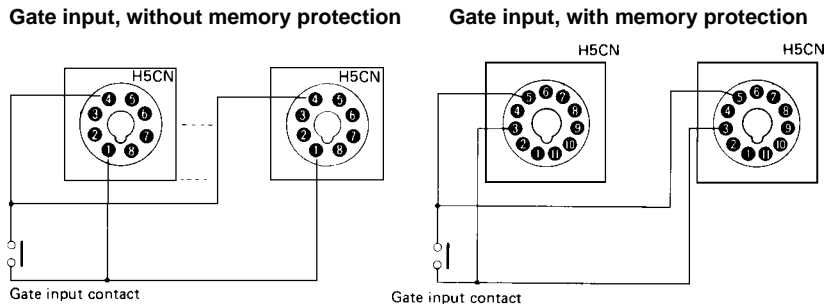

Simultaneous input to H5CN, continued

Reset input, without memory

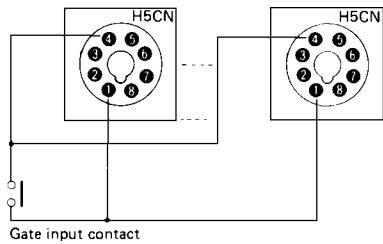

Reset input, with memory protection

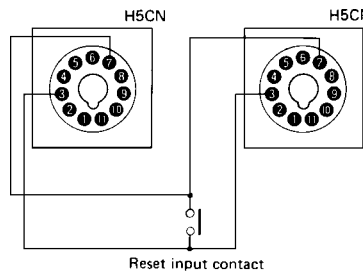

Reset and gate inputs, without memory

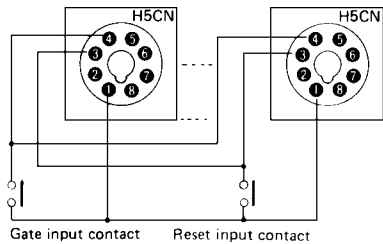

Reset and gate inputs, with memory protection

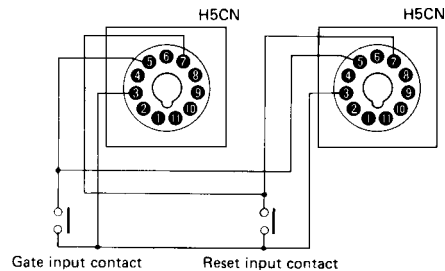

Operation

■ SETTING THE TIME PRESET

Use the four pushwheel switches on the front panel to set the desired time. The H5CN timer does not display the decimal point. Firmly push the switches to avoid having two numbers appear in the display window. This causes the operating time to drift widely.

Do not change the setting while the timer is powered up. It may cause a momentary output to occur.

Undesirable settings

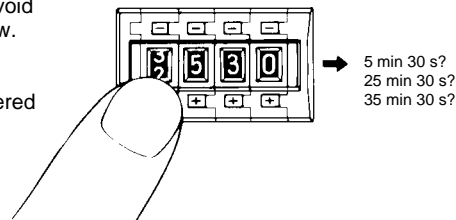

WARNING

Do not set all four digits to zero. This causes a momentary output to occur that may lead to accidental injury or damage.

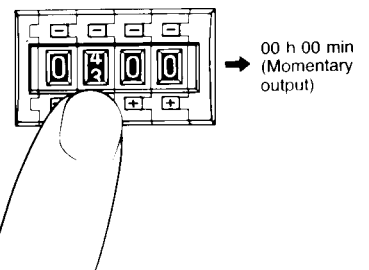

Mounting

■ PANEL MOUNTING

Using Y92F-30 Adapter

Insert the timer through the panel cutout. Push the Y92F-30 adapter from the rear of the timer as far forward toward the panel as possible. Push the P3G□-□□ socket onto the rear of the timer. Then wire the socket. Tighten the two retaining screws. To release the adapter, lift the tab at the rear of the adapter.

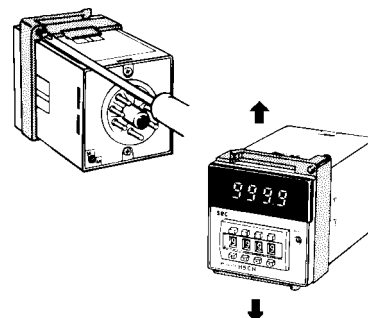

Using Y92F-30 Adapter (continued)

Several timers may be panel mounted close together using Y92F-30 adapter as shown here. When mounting two or more timers in a vertical line, arrange the adapters so that their molded tabs are positioned on the right and left sides. When mounting two or more timers in a horizontal line, arrange the adapters so that their molded tabs are positioned on the top and bottom sides.

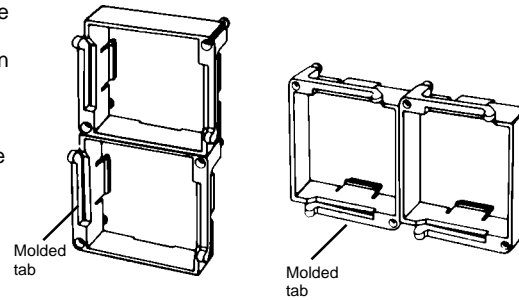

Panel cutout for side-by-side mounting of two timers

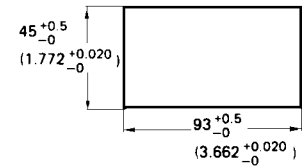

P2CF-□□ Socket

Mounting

The P2CF-□□ socket has two hooks that secure the timer to the socket. Be sure to allow at least 20 mm (0.79 in) clearance above and below the socket to gain access and to release the hooks for servicing and maintenance. Insert timer into the socket. Latch hooks. Then clip rear of the socket to the track. Push the bottom onto the track until the latch hooks securely.

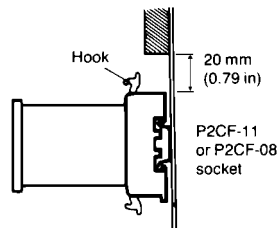

Removal

Pull the latch on the socket with a flat-blade screwdriver and remove the timer and socket as one unit.

NOTE: ALL DIMENSIONS ARE IN MILLIMETERS. To convert millimeters into inches divide by 25.4.

OMRON

OMRON ELECTRONICS, INC.

One East Commerce Drive
Schaumburg, IL 60173

1-800-55-OMRON

OMRON CANADA, INC.

885 Milner Avenue
Scarborough, Ontario M1B 5V8

416-286-6465

X-ON Electronics

Largest Supplier of Electrical and Electronic Components

Click to view similar products for [Timers](#) category:

Click to view products by [Omron](#) manufacturer:

Other Similar products are found below :

[79237785](#) [H5AN-4DM DC12-24](#) [H5CN-YAN AC100-240](#) [H5CX-L8S-N AC100-240](#) [H5AN-4D DC12-24](#) [THR2U-110A](#) [81506944](#)
[88225029](#) [H5S-YB4-X](#) [H7AN-2D DC12-24](#) [H5CN-XANS DC12-48](#) [H7AN-W4DM DC12-24](#) [H7AN-4DM DC12-24](#) [H7AN-4D DC12-24](#)
[H7AN-RT6M AC100-240](#) [600DT-CU](#) [7PV1513-1AP30](#) [7PV1538-1AW30](#) [1SVR508100R0000](#) [1SVR550127R4100](#) [1SVR550212R4100](#)
[1SVR730010R3200](#) [1SVR730020R3300](#) [1SVR730120R3100](#) [1SVR730180R3100](#) [1SVR730211R2300](#) [PCU-511UNI](#) [H3C-R](#) [H3CR-A8-301](#)
[24-48AC/12-48DC](#) [H3CR-A8E 24-48AC/DC](#) [H3CR-F8 100-240AC/100-125DC](#) [H3CR-FN 100-240AC/100-125DC](#) [H3DK-G 24-230AC/DC](#)
[H3DK-HBL AC/DC24-48](#) [H3DK-M1A DC12](#) [LT4H-AC24V](#) [LT4HW8-AC240V](#) [LT4HW-AC240V](#) [LT4HW-AC24VS](#) [31L48AP](#)
[31L48TPM240](#) [RC302](#) [RC312](#) [REV-201M](#) [RG](#) [AT78041](#) [AT78051](#) [ATC180041](#) [TMM1](#) [TMP](#)