

# Digital Daily Time Switch H5F

CSM\_H5F\_DS\_E\_3\_1

## Daily Time Control with Simple Operations

- Specify the operation days.  
(However, you can set only one pattern of operation days and specified days.)
- Up to 12 ON/OFF operations (24 for pulse-output operation).
- Special holidays can be handled easily with the holiday setting function.
- Adjustments for sudden schedule changes can be made easily using output override and automatic return operation.
- The operation program can be checked easily with the program check function.
- Enables pulse output operation and summer time setting.
- Incorporates finger-safe terminals.
- Conforms to UL, CSA, and CE marking.
- Meets a variety of mounting requirements: flush mounting, surface mounting, and DIN track mounting.



## Model Number Structure

### Model Number Legend

H5F-□□B  
1 2

#### 1. Mounting method

- None: Flush mounting
- F: Surface mounting
- K: Surface mounting/track mounting

#### 2. Language

- B: English

## Ordering Information

### List of Models

Wiring	Mounting method	Model
Screw terminals	Flush mounting	H5F-B
	Surface mounting	H5F-FB
	Surface mounting/track mounting	H5F-KB

### Accessories (Order Separately)

Name		Models
Soft cover		Y92A-48F1
Hard cover	For H5F-B	Y92A-48
	For H5F-FB/-KB	Y92A-48E (See note 1.)
Flush Mounting Adapter (See note 2.)		Y92F-30
Mounting Track	50 cm (l) × 7.3 mm (t)	PPF-50N
	1 m (l) × 7.3 mm (t)	PPF-100N
	1 m (l) × 16 mm (t)	PPF-100N2
End Plate		PPF-M
Spacer		PPF-S

- Note:**
1. Supplied with H5F-KB model.
  2. Supplied with H5F-B (flush-mounting) model.

# Specifications

## ■ Ratings

Rated supply voltage	100 to 240 VAC (50/60 Hz)
Operating voltage range	85% to 110% of rated supply voltage
Power consumption	Approx. 2.4 VA at 264 VAC
Control outputs	Contact output: SPST-NO, 15 A at 250 VAC, resistive load, 10 A at 24 VDC, resistive load Minimum applied load: 100 mA at 5 VDC (failure level: P, reference value) NEMA A300 Pilot Duty, 1/3 HP at 120 VAC
External connections	Screw terminals (M3.5 screw)
Terminal screw tightening torque	0.98 to 1.17 N · m

## ■ Characteristics

Accuracy of operating time	±0.01% ±0.05 s max. (see note 1)	
Setting error		
Influence of voltage		
Influence of temperature		
Time accuracy	±15 s per month (at 25°C)	
Memory protection	Continuous use: 5 years min. (at 25°C); Power-interruption rate of 50%: 10 years min. (at 25°C) (see note 2) (lithium battery)	
Insulation resistance	100 MΩ min. (between current-carrying terminals and exposed non-current-carrying metal parts, between operating power supply circuit and control output circuit and between non-continuous contacts)	
Dielectric strength	2,000 VAC, 50/60 Hz for 1 min (between current-carrying terminals and exposed non-current-carrying metal parts and between operating power supply circuit and control output circuit) 1,000 VAC, 50/60 Hz for 1 min (between non-continuous contacts)	
Noise immunity	1.5 kV (between power terminals) Square-wave noise by noise simulator (pulse width: 100 ns/1 μs, 1-ns rise)	
Vibration resistance	Destruction:10 to 55 Hz with 0.375-mm single amplitude, four cycles each in three directions (8 minutes per cycle) Malfunction:10 to 55 Hz with 0.25-mm single amplitude for 10 minutes each in three directions	
Shock resistance	Destruction:300 m/s <sup>2</sup> 3 times each in 6 directions Malfunction:100 m/s <sup>2</sup> 3 times each in 6 directions	
Ambient temperature	Operating:−10°C to 55°C (with no icing) Storage: −25°C to 65°C (with no icing)	
Ambient humidity	Operating: 35% to 85%	
Life expectancy	Mechanical (at 20°C): 100,000 operations min. Electrical (at 20°C): 50,000 operations min. (15 A, 250 VAC, resistive load) 50,000 operations min. (1 HP, 250 VAC, motor load) 50,000 operations min. (10 A, 250 VAC, inductive load (cosφ = 0.7)) 50,000 operations min. (100 W, 100 VAC, lamp load) 10,000 operations min. (300 W, 100 VAC, lamp load)	
Approved safety standards	UL508/Listing, CSA C22.2 No. 14, conforms to EN61010-1 (Pollution degree 2/overvoltage category II) Conforms to VDE0106/P100 (finger protection). Conforms to Electrical Appliance and Material Safety Law (for Japan)	
EMC	(EMI) Emission Enclosure: Emission AC mains: (EMS) Immunity ESD:  Immunity RF-interference:  Immunity Conducted Disturbance: Immunity Burst:  Immunity Surge:  Immunity Voltage Dip/Interruption: Immunity Magnetic Power Field:	EN61326 EN55011 Group 1 class A EN55011 Group 1 class A EN61326 EN61000-4-2: 4 kV contact discharge (level 2) 8 kV air discharge (level 3) EN61000-4-3: 10 V/m (Amplitude-modulated, 80 MHz to 1 GHz, 1.4 to 2 GHz) (level 3)  EN61000-4-6: 10 V (0.15 to 80 MHz) (according to EN61000-6-2) EN61000-4-4: 2 kV power-line (level 3) 1 kV I/O signal-line (level 4) EN61000-4-5: 1 kV line to lines (power and output lines) (level 2); 2 kV line to ground (power and output lines) (level 3) EN61000-4-11: 0.5 cycle, 100% (rated voltage) EN61000-4-8: 30 A/m
Case color	Light gray (Munsell 5Y7/1)	
Weight	H5F-B: approx. 115 g; H5F-KB: approx. 160 g; H5F-FB: approx. 130 g	

**Note:** 1. The total error including the repeat accuracy, setting error, variation due to voltage change, and variation due to temperature change is ±0.01%±0.05 s max. ±0.01% also indicates an error in the time interval of a set time.

2. The total time when power is not being supplied.

# Connections

## Terminal Arrangement

### Flush Mounting Models H5F-B

(Rear View)

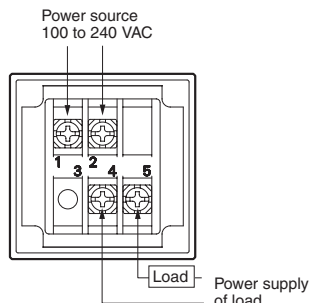

### Surface Mounting Models H5F-FB

(Front View)

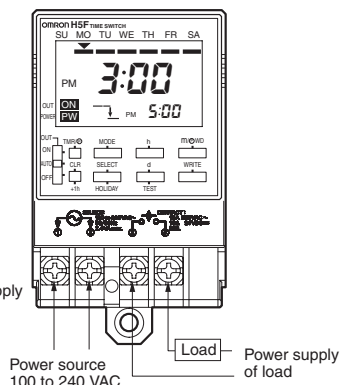

### Surface Mounting/Track Mounting Models H5F-KB

(Front View)

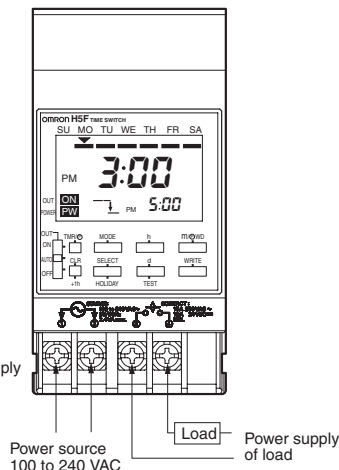

**Note:** 1. The Time Switch uses M3.5 terminals.

2. The Time Switch output is no-voltage contact output. An external power supply is required to drive the load.

3. Applicable wire: 600-V vinyl-insulated wire (solid wire or twisted wire, copper), 14 to 24 AWG, 2 wires max. per terminal.

4. Applicable tightening torque: 0.98 to 1.17 N·m.

5. Recommended fuse: T2A, 250 VAC, time delay, low breaking capacity.

## Operation

### Operation

<b>Operation method</b>	Digital quartz
<b>Time range</b>	24 h × 7 days (Operation days can be specified.)
<b>Operation</b>	<ol style="list-style-type: none"> <li>Daily operation (Multiple-day operation possible.)</li> <li>Pulse-output operation (Pulse width can be set in units of 1 s from 1 to 59 s and in units of 1 min from 1 to 60 min.)</li> <li>Partial operation on specified day (One or some of the operations for certain days can also be executed on other days.)</li> <li>Forced ON/OFF operation</li> <li>Holiday operation</li> <li>Output override and automatic return operation</li> </ol>
<b>Display</b>	<ol style="list-style-type: none"> <li>Day, hours (12-hour (am/pm) or 24-hour clock), minutes (0:00 to 11:59 a.m./ 0:00 to 11:59 p.m., 0:00 to 23:59)</li> <li>Digital display by LCD. Character height: 8 mm</li> <li>Digital display of present time and time schedules for operation</li> <li>Timing chart display of present time and time schedules for operation</li> </ol>
<b>Other functions</b>	Program check function, summer time function
<b>Number of circuits</b>	1 independent circuit
<b>Minimum setting unit</b>	1 min
<b>Minimum set interval</b>	1 min
<b>Number of operations that can be set</b>	24 (see note)

**Note:** Up to 12 ON/OFF operations are possible per day. (For pulse-output operation, the number is 24.)

## ■ Operation Functions

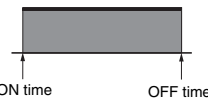
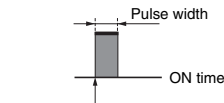
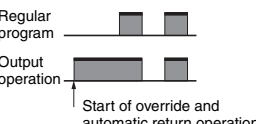
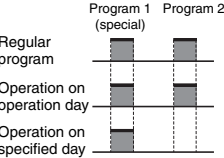
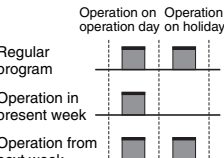
<p><b>Timer operation (ON/OFF operation)</b></p>  <p>ON time      OFF time</p>	<p>Controls the output according to preset of ON and OFF times</p> <ul style="list-style-type: none"> <li>• Minimum setting unit: 1 min</li> <li>• Up to 12 ON/OFF operations are possible per day.</li> </ul>
<p><b>Pulse-output operation</b></p>  <p>Pulse width</p> <p>ON time</p>	<p>Output turns ON for a fixed period (pulse width) at the set time.</p> <ul style="list-style-type: none"> <li>• Pulse width: 1 to 59 s, or 1 to 60 min. (The same pulse width setting is used for all types of output operation.)</li> <li>• The pulse width can be set in units of 1 s or 1 min.</li> <li>• Up to 24 pulse-output operations are possible per day.</li> </ul>
<p><b>Forced ON/OFF operation</b></p>	<p>Forcibly turns ON/OFF the output by the output ON/OFF switch.</p>
<p><b>Override and automatic return operation</b></p>  <p>Regular program</p> <p>Output operation</p> <p>Start of override and automatic return operation</p>	<p>Using the output ON/OFF switch and the Write Key, control output is held in the ON state until the next OFF time.</p> <ul style="list-style-type: none"> <li>• It is also possible to hold the control output in the OFF state until the next ON time.</li> <li>• Operation after the output turns OFF (or ON) will be based on the regular program.</li> <li>• This function can be used with pulse-output operation.</li> </ul>
<p><b>Partial operation on specified day</b></p>  <p>Regular program</p> <p>Operation on operation day</p> <p>Operation on specified day</p> <p>Program 1 (special)    Program 2</p>	<p>The Time Switch operates according to only some of the programs on a user-specified day. (Convenient, for example, for executing a half-day operation on Saturday.)</p> <ul style="list-style-type: none"> <li>• It is not possible to set operation to be executed only on the specified day.</li> <li>• Only one pattern of specified days can be set.</li> <li>• This function can be used with pulse-output operation.</li> </ul>
<p><b>Holiday setting</b></p>  <p>Regular program</p> <p>Operation in present week</p> <p>Operation from next week</p> <p>Operation on operation day    Operation on holiday</p>	<p>It is possible to set a day in the present week as a holiday (i.e., a non-operation day: output OFF regardless of the settings). When that day has passed, operation will continue according to the regular program, and operation will be executed as normal on that day from the following week</p> <ul style="list-style-type: none"> <li>• This function can be used with pulse-output operation.</li> </ul>

**Note:** Both the timer operation and the pulse-output operation cannot be programmed together.

## ■ Operation When Power Turns OFF

1. The time and settings are backed up using a lithium battery.
2. The display stays ON but the output turns OFF.
3. Settings for all types of operation except override and automatic return operation are possible.

# Nomenclature

## Front Panel

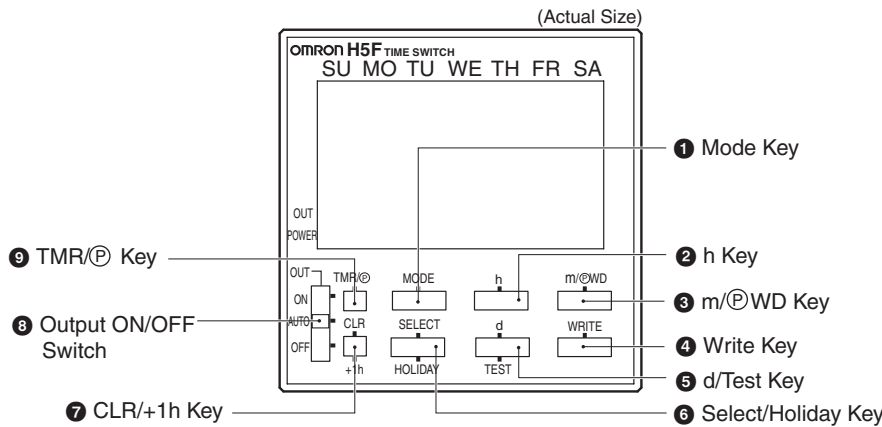

No.	Name	Function
1	Mode Key	Switches between time adjustment mode, the operation setting modes, and run mode.
2	h (Hour) Key	Sets hours or switches between 12-hour (am/pm) and 24-hour display.
3	m/ⓈWD (Minute/Pulse Time Width) Key	Sets minutes or a pulse time width.
4	Write Key	Writes the set data to memory or confirms settings with the program check function.
5	d/Test (Day Shift/Program Test) Key	Moves the cursor to specify a day or starts the program check function.
6	Select/Holiday Key	Specifies or cancels a specified day or switches to holiday setting mode.
7	CLR/+1h (Clear/Summer Time) Key	Erases the set data and initializes the day of operation or sets/clears summer time.
8	Output ON/OFF switch	ON: Turns on the output regardless of the setting. AUTO: Turns on/off the output according to the setting. OFF: Turns off the output regardless of the setting. Override and automatic return operation can be executed by using this key in combination with the Write Key.
9	TMR/Ⓢ (Timer/Pulse output) Key	Selects timer operation or pulse-output operation.

## Display

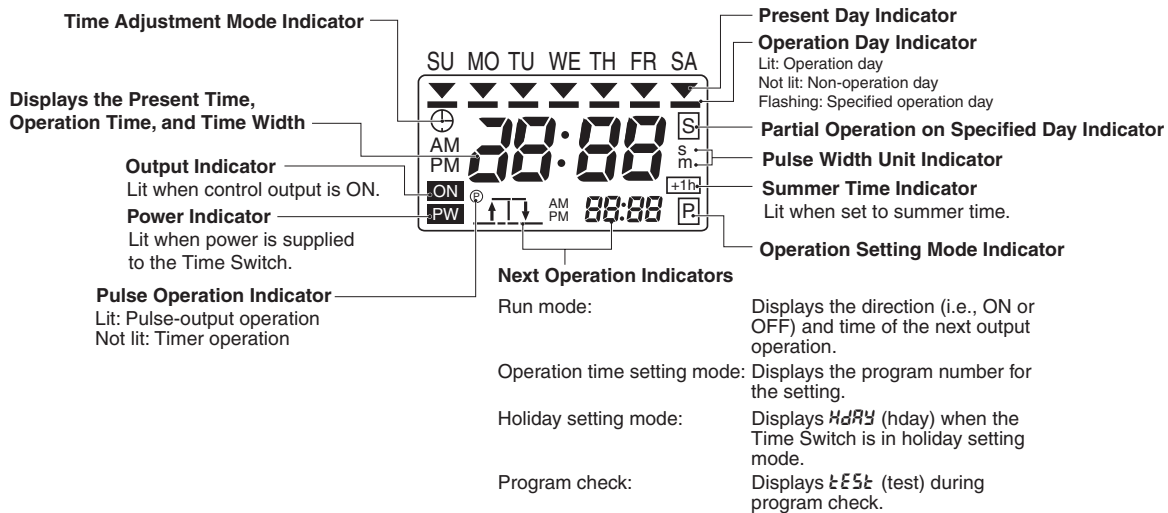

# Dimensions

Note: All units are in millimeters unless otherwise indicated.

## H5F-B (provided with Y92F-30 Flush Mounting Adapter) (Flush Mounting)

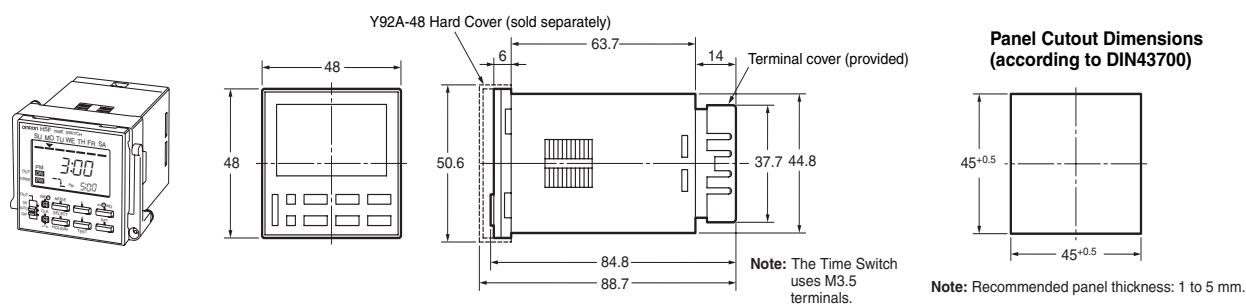

## H5F-FB (Surface Mounting)

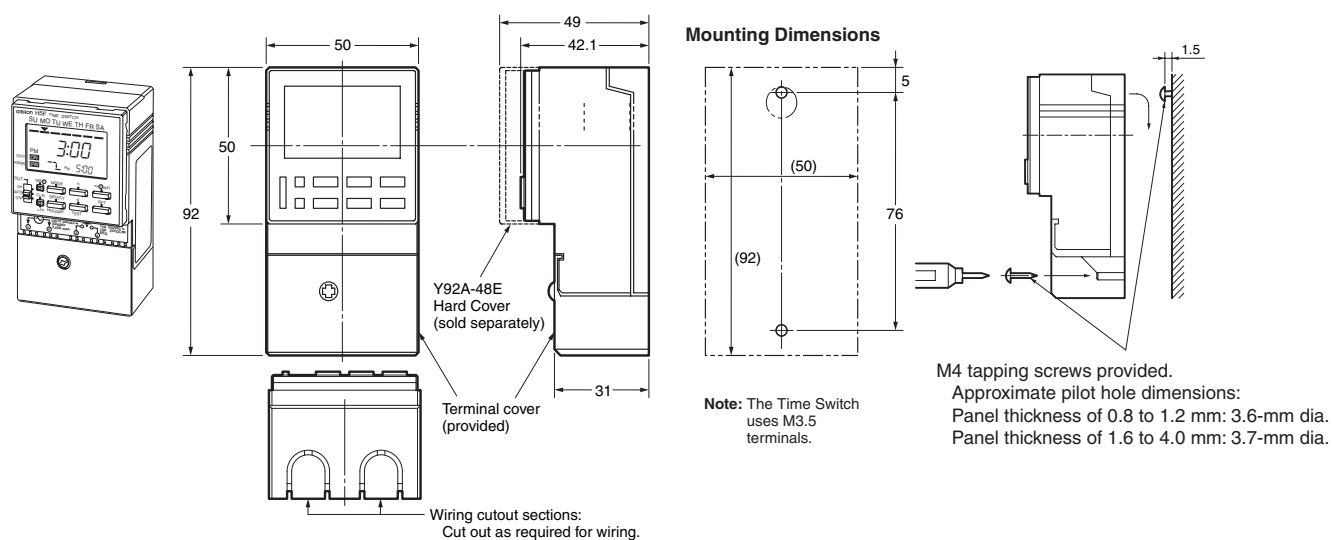

## H5F-KB (Surface/Track Mounting)

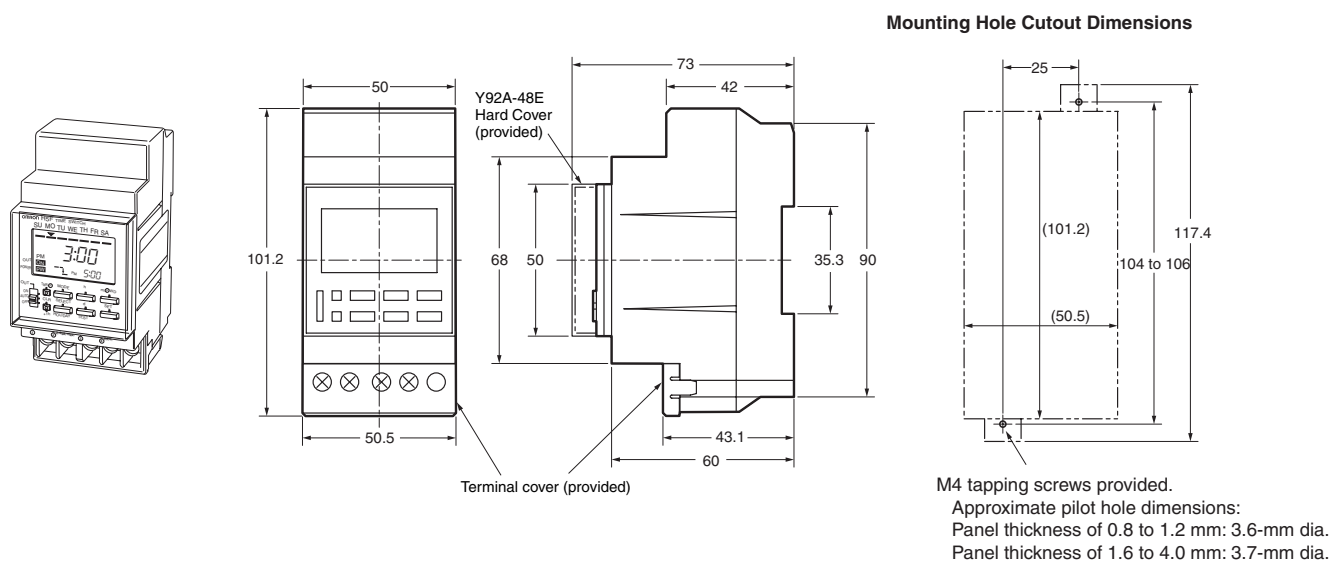

## ■ Accessories (Order Separately)

**Note:** Depending on the operating environment, resin products may deteriorate, contract, or harden. They must be replaced on a regular basis.

### Soft Cover

Y92A-48F1

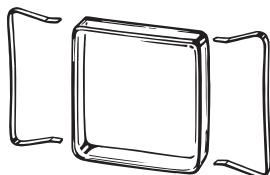

Settings can be changed by pressing on the front of the Cover. The settings are harder to change, however, with the Cover mounted. Confirm that this does not hamper operation. Although the Soft Cover provides protection equivalent to IP54F, do not use the Time Switch in locations where it may be directly subject to splashes of oil.

### Hard Cover (provided with H5F-KB)

Y92F-48 (for H5F-B)

Y92A-48E (for H5F-FB/-KB)

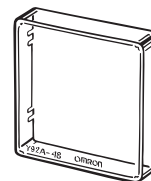

### Flush Mounting Adapter (provided with H5F-B)

Y92F-30

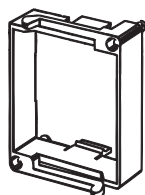

The Flush Mounting Adapter can be purchased individually if it is lost or damaged.

### Mounting Track

PFP-100N, PFP-50N

PFP-100N2

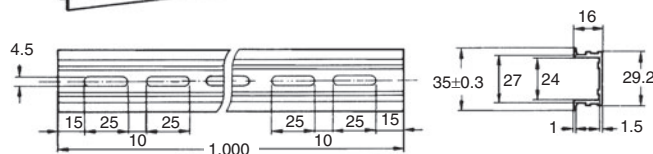
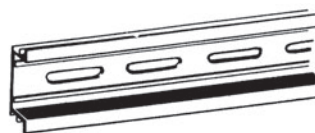
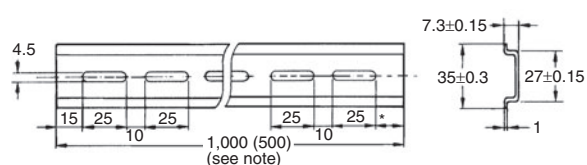
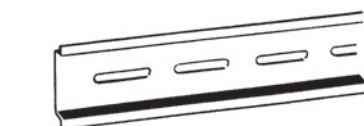

**Note:** The values shown in parentheses are for the PFP-50N.

### End Plate

PFP-M

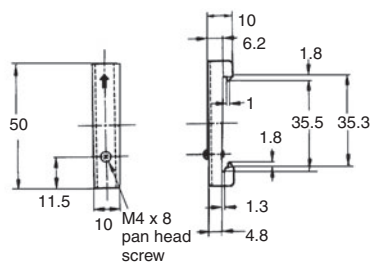
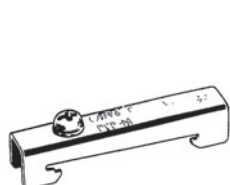

### Spacer

PFP-S

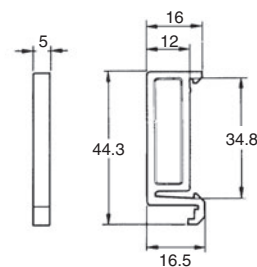
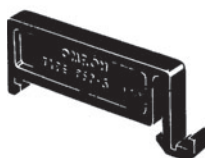

## Precautions

Refer to *Safety Precautions for All Timers*.

### CAUTION

Do not touch any of the terminals while power is being supplied. Doing so may result in electric shock. Be sure to mount the terminal cover after wiring.

Do not use the Time Switch in locations subject to flammable or explosive gases. Doing so may result in explosion.

Do not disassemble, repair, or modify the Time Switch. Doing so may result in electric shock, fire, or malfunction.

Tighten terminal screws to the specified torque (approx. 0.98 N·m). Loose screws may occasionally cause fires or malfunction. (Maximum torque: 1.17 N·m)

Before changing times or other settings while power is being supplied, either turn OFF the power on the load side or set the output ON/OFF switch to OFF and confirm the safety of the system.

The life expectancy of the output relays depends on the switching capacity and switching conditions. Consider the actual application conditions and use the Time Switch within the rated load and electrical service life. If using the Time Switch beyond its ratings is unavoidable, use it together with an electromagnetic switch or contactor as shown in the following diagram.

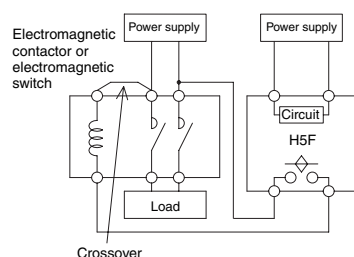

Using the Time Switch beyond its life expectancy may result in contact deposition or burning.

Do not disassemble the Time Switch, deform the Time Switch by applying pressure, heat the Time Switch to temperatures above 100°C, or incinerate the Time Switch. Doing any of these may cause the built-in lithium battery to ignite or rupture.

## Wiring

- Be sure to wire the terminals correctly.
- Do not connect more than two crimp terminals to each Time Switch terminal. Faulty contact may result in burn injury or fire.
- Perform wiring using appropriate wires of the type specified in this document. Using a different type of wire may result in burn injury or fire due to abnormal heat generation.

## Power Supplies

- Make sure that the fluctuation of the supply voltage is within the permissible range.
- Make sure that the voltage applied is within the specified range, otherwise the internal elements of the Time Switch may be damaged.
- Apply the power supply voltage through a breaker, relay or switch in such a way that the voltage reaches a fixed value immediately, otherwise they may not be reset or a Time Switch error may result.
- When the power is turned ON, an inrush current will flow for a short time (approx. 2 A for 0.3 ms at 264 VAC). Depending on the power supply capacity, operation may not start. Be sure to use a power supply with a sufficient capacity and a breaker.

## Operating Environment

- Do not use the Time Switch in locations where condensation may occur due to high humidity or where temperature changes are severe.
- Do not leave the Time Switch for long periods (i.e., one month or longer) at a high temperature with output current in the ON state. Doing so may result in the premature deterioration of internal components (e.g., electrolytic capacitors).
- Separate the Time Switch from any potential sources of noise, such as high-voltage lines. When using inductive loads (e.g., electromagnetic relays), connect noise-absorbing elements (resistor and capacitor) to both ends of the coil.
- Separate the Time Switch from the source of static electricity when using the Time Switch in an environment where a large amount of static electricity is produced (e.g., forming compounds, powders, or fluid materials being transported by pipe).
- Use the Time Switch within the ratings specified for temperature and humidity.
- Do not use the Time Switch in environments subject to shocks or vibration beyond the ranges specified in this document.
- Do not use the Time Switch in locations subject to dust, corrosive gases, or direct sunlight.
- Store at the specified temperature. If the H5F has been stored at a temperature of less than -10°C, allow the H5F to stand at room temperature for at least 3 hours before use.
- This Time Switch is not waterproof or oil-proof. Do not use it in locations where water or oil may enter the Time Switch interior.
- Organic solvents (such as paint thinner), as well as very acidic or basic solutions might damage the outer casing of the H5F.

## Installation

- Mounting the Time Switches side-by-side may reduce the life expectancies of internal components.
- When using heaters, be sure to use a thermal switch for the load circuit.
- When driving an inductive load (e.g., coil), a surge voltage is generated when the contacts (i.e., Time Switch output) are switched, and in some cases this may damage other devices connected to the Time Switch or the same line. Absorb the surge with a capacitor and resistor as shown in the following diagram.

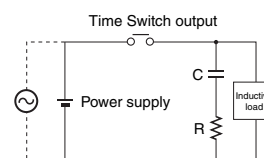

As a rough guide, the capacitor (C) and resistor (R) should have the following specifications:

- C: 0.5 to 1  $\mu$ F for a switching current of 1 A
- R: 0.5 to 1  $\Omega$  for a switching voltage of 1 V

Use a capacitor with a dielectric strength appropriate for the power supply voltage. Use an AC-type capacitor with AC circuits. There may be cases where, due to inconsistencies in the nature and characteristics of the load, delays in restoring the load may cause problems. Be sure to confirm that correct operation is possible under the actual operating conditions.



## ■ Precautions for EN61010-1 Conformance

The H5F Time Switch conforms to EN61010-1 provided that the following conditions are satisfied:

Basic insulation is provided between the power supply and output terminals of the H5F.

- Output terminals are connected to devices without exposed charged parts.
- Output terminals are connected to devices with basic insulation that is suitable for the maximum operating voltage.

## ■ Others

None of the Time Switch components are user-replaceable, including the battery.

# Operating Method

## Operating Method

### Selecting the Mode

All of the modes can be selected using **MODE**, **HOLIDAY**, and **TEST** Keys.

- The days and times when output will actually turn ON/OFF are displayed chronologically.
- Set a special day when the Time Switch will not operate temporarily

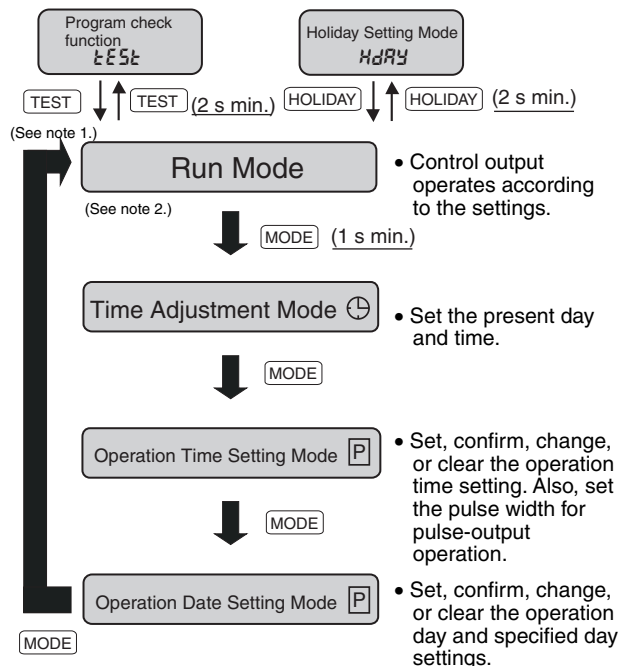

- Note:**
1. After the last item is displayed, the mode automatically returns to run mode.
  2. At the time of delivery, the mode is the run mode.

### Setting the Time

**Example: Changing the current time setting from Wednesday 10:30 am to Monday 4:00 am.**

1. Press the **MODE** Key for 1 s min. to enter time adjustment mode. The symbol flashes.
2. Move the symbol to Monday using the **d** Key. Change the time to 4:00 am using the **h** and **m@WD** Keys.



3. Press the **WRITE** Key. The colon will flash and the clock will start (from 0 s).

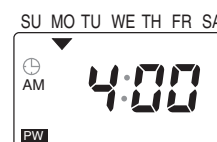

4. Press the **MODE** Key 3 times to return to the run mode.



### Factory Setting

At the time of delivery, the mode is run mode and there is no current time setting. Before making any other settings, press the **MODE** Key for 1 s min. to enter time adjustment mode and set the current time using the above procedure.

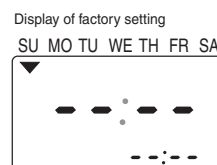

- Note:**
1. The set time is enabled when the **WRITE** Key is pressed.
  2. The time can be displayed in either 12-hour (am/pm) or 24-hour display. (Refer to page 14.)

### Setting Timer Operation

**Example: Setting the Time Switch to operate from Monday to Friday between 8:30 am and 5:15 pm**

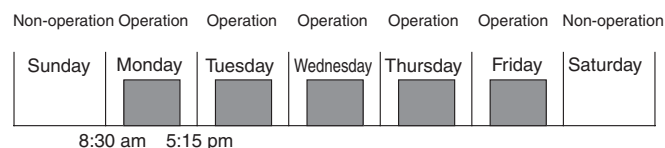

1. Enter operation time setting mode using the **MODE** Key. The **P** symbol flashes.
2. Set the ON time to 8:30 am using the **h** and **m@WD** Keys.
3. Press the **WRITE** Key. (If only the hour or the minute (but not both) is set, the operation setting time display will flash to indicate an error.)
4. Set the OFF time to 5:15 pm using the **h** and **m@WD** Keys.

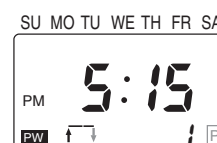
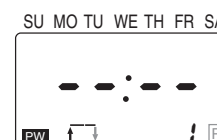
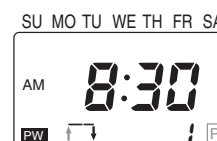
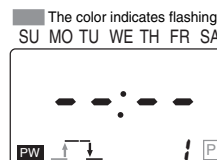

- Press the **[WRITE]** Key.  
(Repeat steps 2 to 5 to make other settings if necessary.)

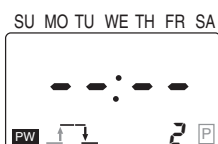

- Press the **[MODE]** Key to enter operation date setting mode.

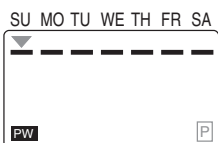

- Move the **▼** symbol to Saturday (or Sunday) using the **[d]** Key. Clear the operation day indicator (**—**) by pressing the **[WRITE]** Key.

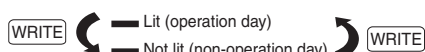

- Press the **[MODE]** Key. The Time Switch will enter run mode and operation based on the settings will start.

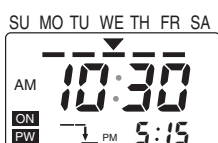

**Note:**

- Up to 12 sets of ON-OFF settings are possible.
- Be sure to set both ON and OFF times. If only the ON time is set, the setting will be invalid.
- At the time of delivery, all days are set as operation days.
- Multiple-day operation is possible.
- Continuous operation for more than 24 hours is possible by combining 2 or more sets of settings. (Refer to page 16.)
- Both the timer operation and the pulse-output operation cannot be programmed together.

## Setting Pulse-output Operation

Using pulse-output operation, the Time Switch can be set to operate at the same time every day for a fixed period.

**Example: Setting the Time Switch to turn ON for 30 s from 8:25 am, Monday to Friday**

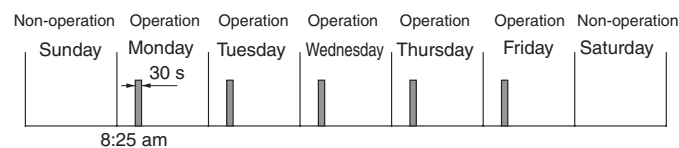

- Enter operation time setting mode using the **[MODE]** Key. The **[P]** symbol flashes.

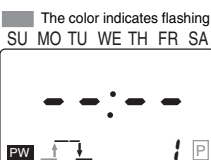

- Press the **[TMR/Ⓟ]** Key to set the Time Switch for pulse-output operation. The **[Ⓟ]** symbol flashes. (The Time Switch is set for timer operation at the time of delivery.)

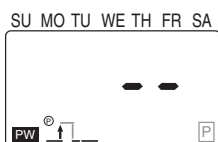

- Set the pulse width to 30 s using the **[m/ⓅWD]** Key. (The pulse width can be set in the range 1 to 59 s or 1 to 60 min.)



- Press the **[WRITE]** Key.

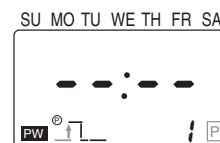

- Set the ON time (the time when pulse-output operation starts) to 8:25 am using the **[h]** and **[m/ⓅWD]** Keys.

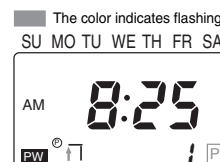

- Press the **[WRITE]** Key. (Repeat steps 5 and 6 to make other settings if necessary.)

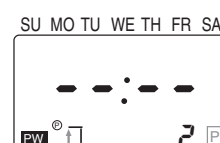

- Press the **[MODE]** Key to enter the operation date setting mode.

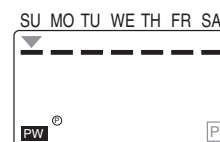

- Move the **▼** symbol to Saturday (or Sunday) using the **[d]** Key. Clear the operation day indicator (**—**) by pressing the **[WRITE]** Key.

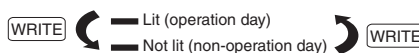
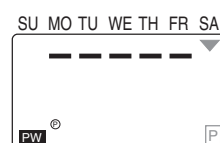

- Press the **[MODE]** Key. The Time Switch will enter run mode and operation based on the settings will start.



**Note:**

- Up to 24 sets of settings are possible.
- Switching between timer operation and pulse-output operation will clear the operation start time, operation day, and pulse width settings.
- Both the timer operation and pulse-output operation cannot be programmed together.

## Setting Partial Operation on Specified Day

The Time Switch can be set to operate according to only some of the settings on a user-specified day.

### Example:

**Monday to Friday:** ON at 8:30 am; OFF at 0:30 pm  
**Saturday:** ON at 1:15 pm; OFF at 0:30 pm

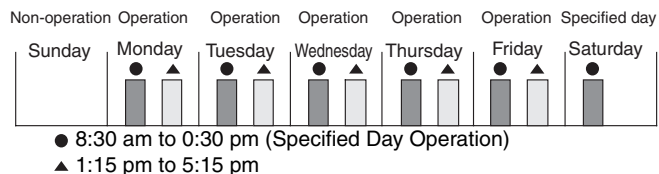

1. Enter operation time setting mode using the **[MODE]** Key.

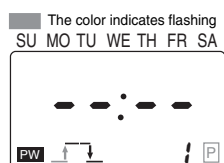

2. Press the **[SELECT]** Key. The **[S]** symbol will be displayed. Set the ON time for the specified day to 8:30 am using the **[h]** and **[m/WD]** Keys.



3. Press the **[WRITE]** Key.

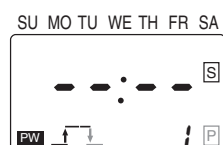

4. Set the OFF time for the specified day to 0:30 pm using the **[h]** and **[m/WD]** Keys.

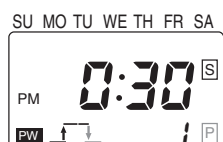

5. Press the **[WRITE]** Key. Set the time to 1:15 pm using the **[h]** and **[m/WD]** Keys.

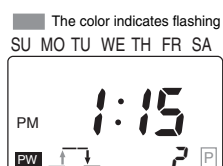

6. Press the **[WRITE]** Key. Set the time to 5:15 pm using the **[h]** and **[m/WD]** Keys.



7. Press the **[WRITE]** Key. Press the **[MODE]** Key to enter operation date setting mode.

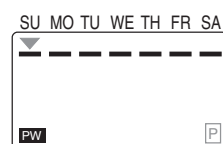

8. Move the **[d]** symbol to Saturday using the **[d]** Key. Make the operation day indicator flash by pressing the **[WRITE]** Key. Move the present day indicator to Sunday using the **[d]** Key. Clear the operation day indicator by pressing the **[WRITE]** Key.

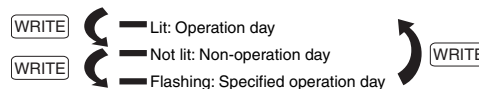

9. Press the **[MODE]** Key. The Time Switch will enter run mode and operation based on the settings will start. The operation day indicator (**[d]**) of the specified day will flash.



**Note:**

1. Partial operation on specified day can be set for two or more programs. For each program, however, the **[S]** must be displayed by pressing the **[SELECT]** Key.
2. Two or more days can be specified as specified days.
3. Partial operation on specified day can also be set for pulse-output operation.

## Changing Timer Operation Settings

**Example: Changing the ON time for program 1 from 8:30 am to 7:45 am**

1. Enter operation time setting mode using the **[MODE]** Key. The ON time for program 1 will be displayed.

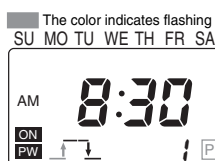

2. Change the ON time to 7:45 am using the **[h]** and **[m/WD]** Keys.

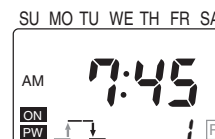

3. Press the **[WRITE]** Key. The OFF time for program 1 will be displayed. (Make changes, if necessary, using the same procedure as for ON time.)



4. Press the **[MODE]** Key to enter operation date setting mode. The operation dates will be displayed. (Make changes, if necessary, using the **[d]** and **[WRITE]** Keys.)

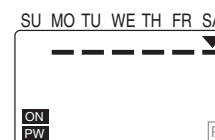

5. Press the **[MODE]** Key. The Time Switch will enter run mode and operation will start.



**Note:** Operation based on the changed settings will start as soon as the Time Switch returns to run mode.

## Changing Pulse-output Operation Settings

### Example: Changing the pulse width from 30 s to 20 s

1. Enter operation time setting mode using **[MODE]** Key. The pulse width is displayed.

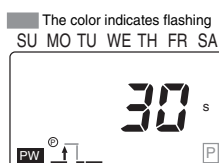

2. Change the pulse width to 20 s using **[m@WD]** Key.

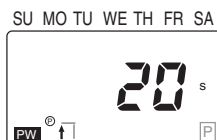

3. Press the **[WRITE]** Key. The ON time for program 1 will be displayed. (Make changes, if necessary, using the **[h]**, **[m@WD]** and **[WRITE]** Key.)

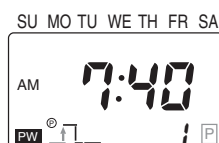

4. Press the **[MODE]** Key to enter operation date setting mode. The operation dates will be displayed. (Make changes, if necessary, using the **[d]** and **[WRITE]** Keys.)

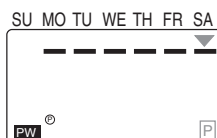

5. Press the **[MODE]** Key. The Time Switch will enter run mode and operation will start.



**Note:** Operation based on the changed settings will start as soon as the Time Switch returns to run mode.

## Clearing the ON/OFF Settings for Individual Programs

### Example: Clearing the settings for program 2

1. Enter operation time setting mode using **[MODE]** Key. The ON time for program 1 will be displayed.

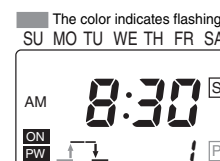

2. Press the **[WRITE]** Key twice. The ON time for program 2 will be displayed.

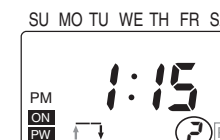

3. Press the **[CLR]** Key. (Both the ON and OFF settings are cleared with just one operation. If this operation is performed while output is ON, output stays ON until the Time Switch returns to run mode.)

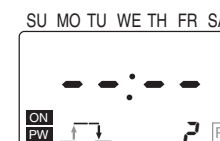

4. Press the **[MODE]** Key twice. The Time Switch will enter run mode and operation based on the new settings (i.e. without the cleared programs) will start.



**Note:** Settings for pulse-output operation can be cleared for individual programs in the same way.

## Clearing all Settings

1. Enter operation time setting mode or operation date setting mode using the **[MODE]** Key.

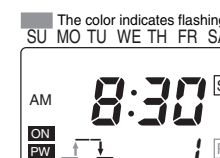

2. Press the **[CLR]** Key for 3 s min. The clearing process will be completed 3 s has elapsed. Output will turn OFF immediately.

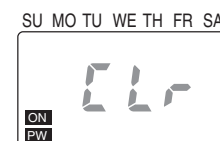

3. When all the settings have been cleared, the operation time, operation day, pulse width, holiday, partial operation on specified day, and override and automatic return operation settings will be returned to their factory settings.

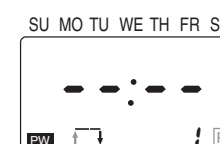

**Note:** The clearing process will be canceled if the **[CLR]** Key is released while **CLR** is still flashing and only the settings for the display program will be cleared.

**Note:** The current time cannot be deleted.

## Holiday Setting Function

The following example shows how to stop operation for a certain day in the present week and restore normal operation from the following week using the holiday setting function.

### Example: Stopping operation for Friday and Saturday in the current week and resuming normal operation from the following week

1. Press the **[HOLIDAY]** Key for 2 s min. in run mode to enter holiday setting mode. *HdRY* will flash and the operation day indicator (—) will light under the days set for operation day.
2. Move the **▼** symbol to Friday using **[d]** Key. Clear the operation day indicator (—) by pressing the **[WRITE]** Key. Repeat the procedure for Saturday. (Press the **[WRITE]** Key again to clear the holiday setting.)
3. Press the **[HOLIDAY]** Key. The Time Switch will enter run mode and the operation day indicator under the days set as holidays will turn OFF. (When a day set as a holiday has passed, the (—) indicator under that day will automatically turn ON again.)

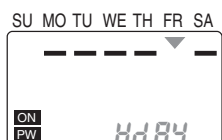
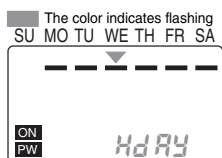

- Note:**
1. Any day in the 7-day period starting from the present day can be set as a holiday.
  2. Operation based on the new settings (i.e., including the holiday setting) will start as soon as the Time Switch returns to run mode.
  3. Holiday setting mode can be entered from run mode only.
  4. If the present day setting in time adjustment mode is changed, all holiday settings will be cleared.
  5. If a day set as a holiday is changed in operation date setting mode, the holiday setting for that day will be cleared.

## Summer Time (DST) Function

The summer time function allows the Time Switch to be used in regions that observe daylight saving time during the summer.

Each time the **[+1h]** Key is pressed in run mode, the present time will switch between the (standard) present time and the present time + 1 hour (summer time).

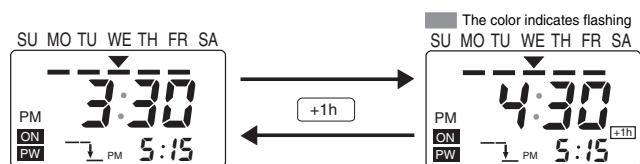

- Note:**
1. The summer time indicator (**[+1h]**) is displayed while summer time is set.
  2. The contents of the programs are not changed.
  3. The summer time setting can only be set or cleared in run mode.

## Switching between 12-hour (am/pm) and 24-hour Display

Each time the **[h]** Key is pressed for 2 s min. in run mode, the time display switches between 12-hour (am/pm) and 24-hour display.

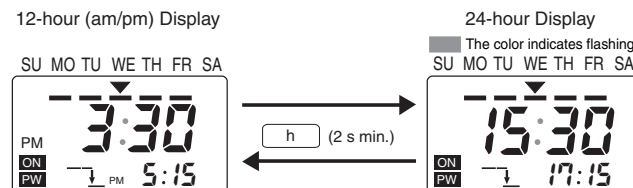

- Note:**
1. Switching is possible only in run mode.
  2. The factory setting is 12-hour (am/pm) display.

## Override and Automatic Return Operation

Override and automatic return operation can be used to handle sudden schedule changes without making changes to the program. The output status can be set to ON or OFF directly using the output ON/OFF switch. This output status is then held until the next ON/OFF operation time.

### Example 1: Starting operation earlier than the scheduled time on the present day only

**Regular setting:** ON at 8:30 am; OFF at 5:15 pm

**Use the following procedure to start operation at 7:00 am for the present day only.**

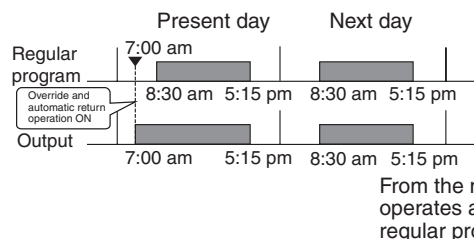

From the next day, output operates according to the regular program.

1. Change the setting of the output ON/OFF switch from AUTO to ON.
2. Return the setting of the output ON/OFF switch from ON to AUTO while holding down the **[WRITE]** Key. The ON state will be held from the point at which this operation is performed (indicated by the arrow) until the next (regular) OFF time.

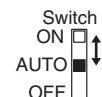

### Example 2: Stopping operation earlier than the scheduled time on the present day only

**Regular setting:** ON at 8:30 am; OFF at 5:15 pm

**Use the following procedure to stop operation at 3:00 pm for the present day only.**

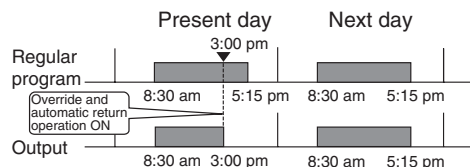

From the next day, output operates according to the regular program.

1. Change the setting of the output ON/OFF switch from AUTO to OFF.

- Return the setting of the output ON/OFF switch from OFF to AUTO while holding down the **WRITE** Key. The OFF state will be held from the point at which this operation is performed (indicated by the arrow) until the next (regular) ON time.



- Note:**
- This operation is possible in run mode only.
  - Override and automatic return operation can be cleared by setting the output ON/OFF switch to the opposite of the present status. For example, if the output is ON, override and automatic return operation can be cleared by setting the output ON/OFF switch to OFF.
  - Override and automatic return operation cannot be set or cleared if power is not being supplied to the Time Switch.
  - Override and automatic return operation is cleared if any of the settings are changed.

### Using Override and Automatic Return Operation for Pulse-output Operation

Override and automatic return operation proceeds in the following way when used for pulse-output operation.

- If override and automatic return operation starts with a forced ON, output is turned ON for the time corresponding to the set pulse width.
- If override and automatic return operation starts from a forced OFF, output remains OFF until the pulse output ends.

The operation method is the same as for timer operation.

#### Example 1: Override and automatic return operation starting with a forced ON while output is ON (pulse width: 30 min)

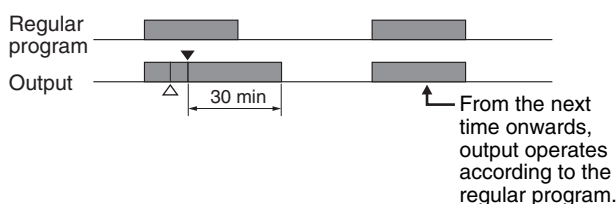

- △ Point at which the Output ON/OFF Key changes from AUTO to ON.
- ▽ Point at which the Output ON/OFF Key changes from ON to AUTO with the **WRITE** Key held down.

#### Example 2: Override and automatic return operation starting with a forced ON while output is OFF (pulse width: 30 min)

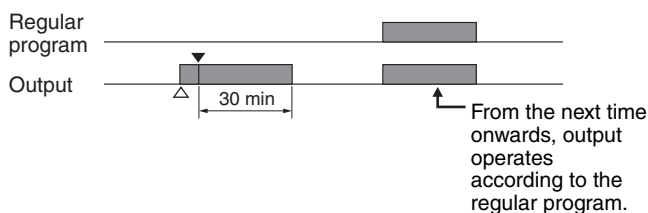

- △ Point at which the Output ON/OFF Key changes from AUTO to ON.
- ▽ Point at which the Output ON/OFF Key changes from ON to AUTO with the **WRITE** Key held down.

#### Example 3: Override and automatic return operation starting from a forced OFF while output is ON (pulse width: 30 min)

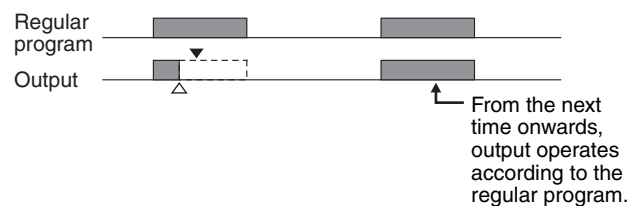

- △ Point at which the Output ON/OFF Key changes from AUTO to OFF.
- ▽ Point at which the Output ON/OFF Key changes from OFF to AUTO with the **WRITE** Key held down.

### Program Check Function

The days and times at which output turns ON or OFF over the course of one week can be displayed continuously in the actual order in which they will occur.

- Press the **TEST** Key for 2 s min. in run mode to start the program check.

The display will flash **EESE** and the day and time of the next change in output status will be displayed.

The color ■ indicates flashing items.



In the above example, output will turn ON at 1:15 pm on Monday.

- Press the **WRITE** Key. The display will change to the day and time of the next change in output status. (Continue pressing the **WRITE** Key to display the days and times for one week.)



In the above example, output will turn OFF at 5:30 pm on Monday.

- If the **WRITE** Key is pressed with the last setting for the week displayed, **End** is displayed for 2 s and then the Time Switch automatically returns to run mode.



- Note:**
- The program check can be started from run mode only.
  - Press the **TEST** Key again to return to run mode before reaching the end of the program check function display sequence.
  - The ON and OFF symbols (  $\overline{\text{---}}$  /  $\text{---}$  ) displayed during program check have no effect on the present operation.
  - Only ON times are displayed for pulse-output operation.

## Setting Examples

As shown in the following examples, continuous operation for more than 24 hours is possible by combining two or more settings. Refer to Setting Precautions for more details.

**Example 1: Use the settings given below to turn ON output from 8:30 am on Monday right through to 0:30 pm on Saturday.**

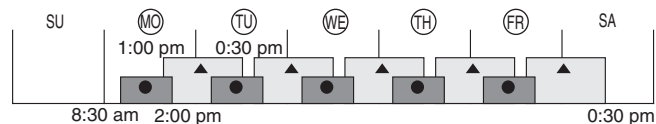

Operation time settings:

- ▲ 1:00 pm to 0:30 pm
- 8:30 am to 2:00 pm

Operation day settings:

Operation day ( ○ ): Monday, Tuesday, Wednesday, Thursday, Friday

**Example 2: Use the settings given below to turn ON output from 1:00 pm on Monday right through to 8:00 am on Saturday.**

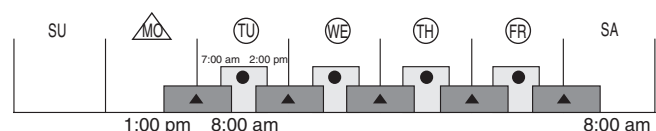

Operation time settings:

- ▲ 1:00 pm to 8:00 am (specified day operation)
- 7:00 am to 2:00 pm

Operation day settings:

Specified day ( △ ): Monday

Operation day ( ○ ): Tuesday, Wednesday, Thursday, Friday

**Example 3: Use the settings given below to turn ON output from 8:00 pm to 7:00 am from Monday to Thursday and from 8:00 pm on Friday right through to 7:00 am on Monday.**

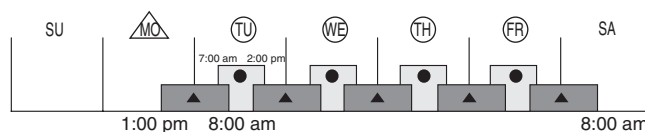

Operation time settings:

- ▲ 1:00 pm to 8:00 am (specified day operation)
- 7:00 am to 2:00 pm

Operation day settings:

Specified day ( △ ): Monday

Operation day ( ○ ): Tuesday, Wednesday, Thursday, Friday

## Setting Precautions

1. If settings overlap, the earliest ON time and the latest OFF time will be used.

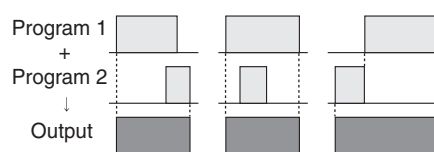

- Output will stay ON continuously without interruption.
  - If an ON and OFF setting are made for the same time, the output status will not change at that time.
2. If there is a switch between timer operation and pulse-output operation, the operation time, operation day, and pulse width settings will all be cleared.

ALL DIMENSIONS SHOWN ARE IN MILLIMETERS.

To convert millimeters into inches, multiply by 0.03937. To convert grams into ounces, multiply by 0.03527.

In the interest of product improvement, specifications are subject to change without notice.



## Read and Understand This Catalog

Please read and understand this catalog before purchasing the products. Please consult your OMRON representative if you have any questions or comments.

## Warranty and Limitations of Liability

### WARRANTY

OMRON's exclusive warranty is that the products are free from defects in materials and workmanship for a period of one year (or other period if specified) from date of sale by OMRON.

OMRON MAKES NO WARRANTY OR REPRESENTATION, EXPRESS OR IMPLIED, REGARDING NON-INFRINGEMENT, MERCHANTABILITY, OR FITNESS FOR PARTICULAR PURPOSE OF THE PRODUCTS. ANY BUYER OR USER ACKNOWLEDGES THAT THE BUYER OR USER ALONE HAS DETERMINED THAT THE PRODUCTS WILL SUITABLY MEET THE REQUIREMENTS OF THEIR INTENDED USE. OMRON DISCLAIMS ALL OTHER WARRANTIES, EXPRESS OR IMPLIED.

### LIMITATIONS OF LIABILITY

OMRON SHALL NOT BE RESPONSIBLE FOR SPECIAL, INDIRECT, OR CONSEQUENTIAL DAMAGES, LOSS OF PROFITS OR COMMERCIAL LOSS IN ANY WAY CONNECTED WITH THE PRODUCTS, WHETHER SUCH CLAIM IS BASED ON CONTRACT, WARRANTY, NEGLIGENCE, OR STRICT LIABILITY.

In no event shall the responsibility of OMRON for any act exceed the individual price of the product on which liability is asserted.

IN NO EVENT SHALL OMRON BE RESPONSIBLE FOR WARRANTY, REPAIR, OR OTHER CLAIMS REGARDING THE PRODUCTS UNLESS OMRON'S ANALYSIS CONFIRMS THAT THE PRODUCTS WERE PROPERLY HANDLED, STORED, INSTALLED, AND MAINTAINED AND NOT SUBJECT TO CONTAMINATION, ABUSE, MISUSE, OR INAPPROPRIATE MODIFICATION OR REPAIR.

## Application Considerations

### SUITABILITY FOR USE

OMRON shall not be responsible for conformity with any standards, codes, or regulations that apply to the combination of products in the customer's application or use of the products.

At the customer's request, OMRON will provide applicable third party certification documents identifying ratings and limitations of use that apply to the products. This information by itself is not sufficient for a complete determination of the suitability of the products in combination with the end product, machine, system, or other application or use.

The following are some examples of applications for which particular attention must be given. This is not intended to be an exhaustive list of all possible uses of the products, nor is it intended to imply that the uses listed may be suitable for the products:

- Outdoor use, uses involving potential chemical contamination or electrical interference, or conditions or uses not described in this catalog.
- Nuclear energy control systems, combustion systems, railroad systems, aviation systems, medical equipment, amusement machines, vehicles, safety equipment, and installations subject to separate industry or government regulations.
- Systems, machines, and equipment that could present a risk to life or property.

Please know and observe all prohibitions of use applicable to the products.

NEVER USE THE PRODUCTS FOR AN APPLICATION INVOLVING SERIOUS RISK TO LIFE OR PROPERTY WITHOUT ENSURING THAT THE SYSTEM AS A WHOLE HAS BEEN DESIGNED TO ADDRESS THE RISKS, AND THAT THE OMRON PRODUCTS ARE PROPERLY RATED AND INSTALLED FOR THE INTENDED USE WITHIN THE OVERALL EQUIPMENT OR SYSTEM.

### PROGRAMMABLE PRODUCTS

OMRON shall not be responsible for the user's programming of a programmable product, or any consequence thereof.

## Disclaimers

### CHANGE IN SPECIFICATIONS

Product specifications and accessories may be changed at any time based on improvements and other reasons.

It is our practice to change model numbers when published ratings or features are changed, or when significant construction changes are made. However, some specifications of the products may be changed without any notice. When in doubt, special model numbers may be assigned to fix or establish key specifications for your application on your request. Please consult with your OMRON representative at any time to confirm actual specifications of purchased products.

### DIMENSIONS AND WEIGHTS

Dimensions and weights are nominal and are not to be used for manufacturing purposes, even when tolerances are shown.

### PERFORMANCE DATA

Performance data given in this catalog is provided as a guide for the user in determining suitability and does not constitute a warranty. It may represent the result of OMRON's test conditions, and the users must correlate it to actual application requirements. Actual performance is subject to the OMRON Warranty and Limitations of Liability.

### ERRORS AND OMISSIONS

The information in this document has been carefully checked and is believed to be accurate; however, no responsibility is assumed for clerical, typographical, or proofreading errors, or omissions.

2011.10

In the interest of product improvement, specifications are subject to change without notice.

**OMRON Corporation**  
Industrial Automation Company

<http://www.ia.omron.com/>

(c)Copyright OMRON Corporation 2011 All Right Reserved.

## X-ON Electronics

Largest Supplier of Electrical and Electronic Components

*Click to view similar products for [Timers](#) category:*

*Click to view products by [Omron](#) manufacturer:*

Other Similar products are found below :

[79237785](#) [H5AN-4DM DC12-24](#) [H5CN-YAN AC100-240](#) [H5CX-L8S-N AC100-240](#) [H5AN-4D DC12-24](#) [THR2U-110A](#) [81506944](#)  
[88225029](#) [H5S-YB4-X](#) [H7AN-2D DC12-24](#) [H5CN-XANS DC12-48](#) [H7AN-W4DM DC12-24](#) [H7AN-4DM DC12-24](#) [H7AN-4D DC12-24](#)  
[H7AN-RT6M AC100-240](#) [600DT-CU](#) [7PV1513-1AP30](#) [7PV1538-1AW30](#) [1SVR508100R0000](#) [1SVR550127R4100](#) [1SVR550212R4100](#)  
[1SVR730010R3200](#) [1SVR730020R3300](#) [1SVR730120R3100](#) [1SVR730180R3100](#) [1SVR730211R2300](#) [PCU-511UNI](#) [H3C-R](#) [H3CR-A8-301](#)  
[24-48AC/12-48DC](#) [H3CR-A8E 24-48AC/DC](#) [H3CR-F8 100-240AC/100-125DC](#) [H3CR-FN 100-240AC/100-125DC](#) [H3DK-G 24-230AC/DC](#)  
[H3DK-HBL AC/DC24-48](#) [H3DK-M1A DC12](#) [LT4H-AC24V](#) [LT4HW8-AC240V](#) [LT4HW-AC240V](#) [LT4HW-AC24VS](#) [31L48AP](#)  
[31L48TPM240](#) [RC302](#) [RC312](#) [REV-201M](#) [RG](#) [ETR4-51-A](#) [AT78041](#) [AT78051](#) [ATC180041](#) [TMM1](#)