

Subminiature Tachometers With Improved Appearance and Features

- Large display with 8.6 mm (0.338 in) height
- Available with backlit LCD
- Revolutions displayed up to five digits.
- PNP/NPN DC voltage input available
- Switchable dual revolution display type available (-NV1 models); extended up to $10000 \text{ m}^{-1} \{\text{rpm}\}$
- Dual revolution display according to encoder resolution used; $1000 \text{ s}^{-1} \{\text{rps}\}/1000 \text{ m}^{-1} \{\text{rpm}\}$ or $1000.0 \text{ s}^{-1} \{\text{rps}\}/1000.0 \text{ m}^{-1} \{\text{rpm}\}$
- NEMA 4/IP66 front
- Replaceable battery
- New black case



Ordering Information

■ TACHOMETERS

Count input	Display	Max. revolutions displayed (applicable encoder resolution)	
		$1000 \text{ s}^{-1} \{\text{rps}\}$ (1 pulse/rev.), $1000 \text{ m}^{-1} \{\text{rpm}\}$ (60 pulse/rev.)	$1000.0 \text{ s}^{-1} \{\text{rps}\}$ (10 pulse/rev.), $1000.0 \text{ m}^{-1} \{\text{rpm}\}$ (600 pulse/rev.) \longleftrightarrow $10000 \text{ m}^{-1} \{\text{rpm}\}$ (60 pulse/rev.) (switchable)
		Part number	
PNP/NPN universal DC voltage input	7-segment LCD with backlight	H7ER-NV-BH	H7ER-NV1-BH
	7-segment LCD	H7ER-NV-B	H7ER-NV1-B
No-voltage input	7-segment LCD	H7ER-N-B	---

■ MODEL NUMBER LEGEND

H7ER - N -

1 2 3 4

1. Count Input

None: No-voltage input
V: PNP/NPN universal DC voltage input

2. Number of Digits

None: 4 digits
1: 5 digits

3. Case Color

B: Black

4. Display

None: 7-segment LCD without backlight
H: 7-segment LCD with backlight

■ ACCESSORIES (ORDER SEPARATELY)

Item	Part number	
Replacement Battery	Y92S-36	
Wire-wrap Terminal (Set of two Terminals)	Y92S-37	
Flush Mounting Adapter	26 mm × 45 mm	Y92F-75
	24.8 mm × 48.8 mm	Y92F-77B

Specifications

■ GENERAL

Item	H7ER-NV-B H7ER-NV-BH	H7ER-N-B	H7ER-NV1-B H7ER-NV1-BH
Operating mode	Up type		
Mounting method	Flush mounting		
External connections	Screw terminals, Wire-wrap Terminals (See Note 3.)		
Display	7-segment LCD with or without backlight (character height: 8.6 mm) (See Note 4.)		
Number of digits	4		5
Count input	PNP/NPN universal DC voltage input	No-voltage input	PNP/NPN universal DC voltage input
Max. counting speed	1 kHz		10 Hz
Max. revolutions displayed (See Note 5.)	1,000 s ⁻¹ {rps} (When encoder resolution of 1 pulse/rev is used.) 1,000 m ⁻¹ {rpm} (When encoder resolution of 60 pulse/rev is used.)		1,000.0 s ⁻¹ {rps} (When encoder resolution of 10 pulse/rev is used.) 1,000.0 m ⁻¹ {rpm} (When encoder resolution of 600 pulse/rev is used.) ↔ 10,000 m ⁻¹ {rpm} (When encoder resolution of 60 pulse/rev is used.) (Switchable with switch)
Attachment	Waterproof packing, flush mounting bracket, revolution unit labels (See Note 5.)		
Approved standard	UL508, CSA C22.2 No.14, Lloyds Conforms to EN61010-1/IEC61010-1 (Pollution degree2/overvoltage category III) Conforms to VDE0106/P100		

- Note:**
- Reset is not available.
 - When there is no input, the display will be 0.0 or 0.
 - Wire-wrap Terminals (Y92S-37) can be ordered separately
 - Only PNP/NPN Universal DC voltage input models are available with a backlight.
 - "rpm," "rps," "s⁻¹," and "m⁻¹," labels are included.

■ RATINGS

Item	H7ER-NV□-B H7ER-NV□-BH	H7ER-N-B
Supply voltage	Backlight model: 24 VDC (for backlight lit) No-backlight model: Not required (powered by battery)	Not required (powered by battery)
Count input	High (logic) level: 4.5 to 30 VDC Low (logic) level: 0 to 2 VDC (Input impedance: Approx. 4.7 kΩ)	No voltage input Maximum short-circuit impedance: 10 kΩ max. Short-circuit residual voltage: 0.5 V max. Minimum open impedance: 750 kΩ min.
Reset input		
Max. counting speed	5-digit models: 10 Hz 4-digit models: 1 kHz	1 kHz
Minimum signal width	10 Hz: 0.05 ms 1 kHz: 0.5 ms	
Terminal screw tightening torque	0.98 N • m max.	
Ambient temperature	Operating: -10°C to 55°C (with no icing) Storage: -25°C to 65°C (with no icing)	
Ambient humidity	Operating: 25% to 85%	

■ CHARACTERISTICS

Item	H7ER-NV□-B H7ER-NV□-BH	H7ER-N-B
Insulation resistance	100 MΩ min. (at 500 VDC) between current-carrying metal parts and exposed non-current-carrying metal parts, and between the backlight power supply and count input terminals/reset terminals for backlight models	100 MΩ min. (at 500 VDC) between current-carrying metal parts and exposed non-current-carrying metal parts
Dielectric strength	1,000 VAC, 50/60 Hz for 1 min between current-carrying metal parts and exposed non-current-carrying metal parts and between the backlight power supply and count input terminals/reset terminals for backlight models	1,000 VAC, 50/60 Hz for 1 min between current-carrying metal parts and exposed non-current-carrying metal parts
Impulse withstand voltage	4.5 kV between current-carrying terminal and exposed non-current-carrying metal parts	
Noise immunity	Between input terminals: ±600 V in normal mode, ±1.5 kV in command mode For backlight power supply (backlight model): ±480 V in normal mode, ±1.5 kV in command mode	±500 V in normal mode, ±1.5 kV in command mode
Static immunity	±8 kV (malfunction)	
Vibration resistance	Malfunction: 0.15-mm single amplitude at 10 to 55 Hz for 10 min each in 3 directions Destruction: 0.375-mm single amplitude at 10 to 55 Hz for 2 hrs each in 3 directions	
Shock resistance	Malfunction: 200 m/s ² 3 times each in 6 directions Destruction: 300 m/s ² 3 times each in 6 directions	
Battery life	7 years min. with continuous input at 25°C (lithium battery)	
EMC	(EMI) Emission Enclosure: EN50081-1 EN55022 class B (EMS) Immunity ESD: EN50082-2 EN61000-4-2: 4-kV contact discharge (level 2) 8-kV air discharge (level 3) Immunity RF-interference from AM Radio Waves: ENV50140: 10 V/m (80 MHz to 1 GHz) (level 3) Immunity RF-interference from Pulse-modulated Radio Waves: ENV50204: 20 V/m (900 MHz ± 5 MHz) (level 3) Immunity Conducted Disturbance: ENV50141: 10 V (0.15 to 80 MHz) (level 3) Immunity Burst: EN61000-4-4: 2-kV power line (level 3) 2-kV I/O signal line (level 4)	
Enclosure rating	Front panel: IP66, NEMA4 Terminal block: IP20	
Weight (see Note.)	Non-backlight model: Approx. 60 g Backlight model: Approx. 65 g	

Note: Weight includes waterproof packing and panel mounting bracket.

Nomenclature

TACHOMETER

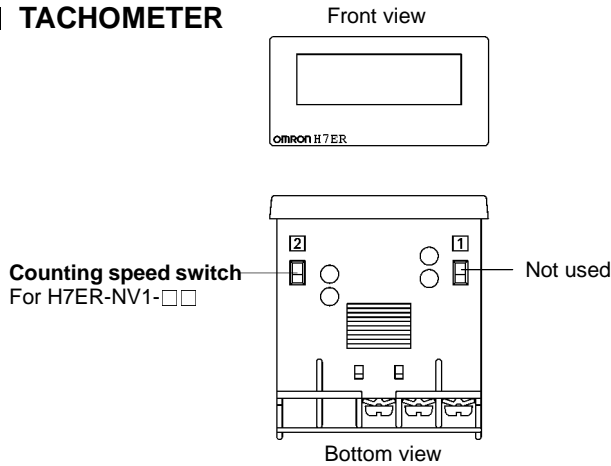

Counting Speed Switch Settings and Unit Label Application

Model	Counting speed switch setting (see note)	Max. revolutions displayed	Applicable encoder resolution	Applicable unit label
H7ER-NV1-□□	Front panel ↑	10000 m ⁻¹ {rpm} (default setting)	60 pulse/rev.	"m ⁻¹ " or "rpm"
	Terminal block ↓	1000.0 m ⁻¹ {rpm}	600 pulse/rev.	"m ⁻¹ " or "rpm"
		1000.0 s ⁻¹ {rps}	10 pulse/rev.	"s ⁻¹ " or "rps"
H7ER-N-□ H7ER-NV-□□	No setting is required	1000 m ⁻¹ {rpm}	60 pulse/rev.	"m ⁻¹ " or "rpm"
		1000 s ⁻¹ {rps}	1 pulse/rev.	"s ⁻¹ " or "rps"

Note: Perform switch setting before mounting to a control panel.

Operation

OPERATING MODES

H7ER Tachometer

Incrementing Operation
Within Unit Time (Up)

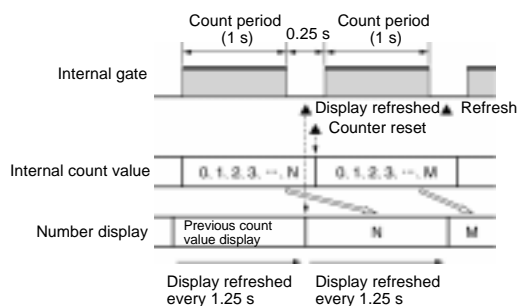

Dimensions

Unit: mm (inch)

■ H7ER-N

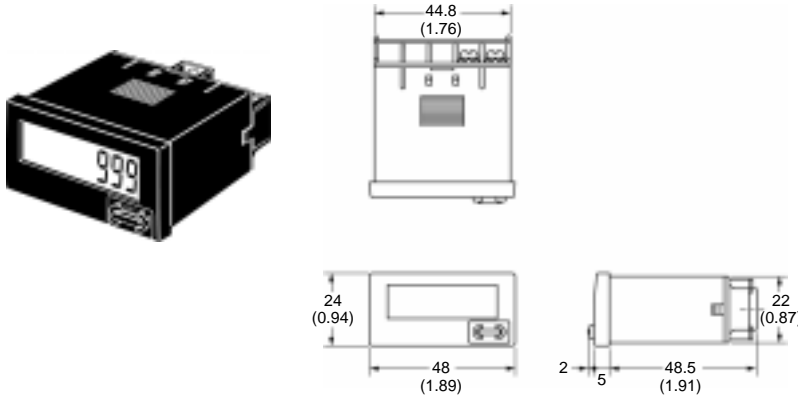

Panel Cutout

Separate mounting

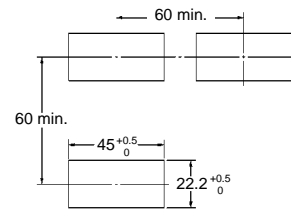

Joint mounting

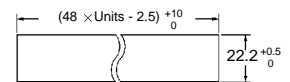

Dimensions with Flush Mounting Bracket

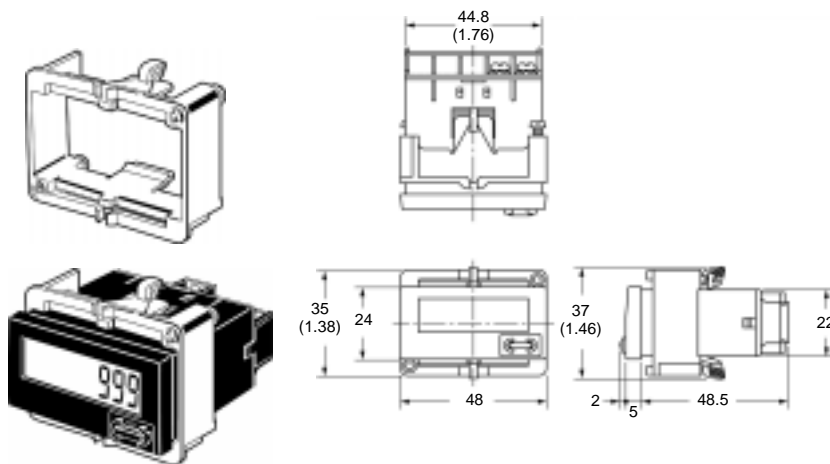

Waterproofing is not possible for joint mounting

- When mounting, insert the Counter into the cutout. Insert the adapter from the back and push in the Counter while making the gap between the front panel and the cutout panel as small as possible. Use screws to secure the Counter. If waterproofing is desired, insert the waterproof packing.
- When several Counters are installed, ensure that the ambient temperature will not exceed specifications.
- The appropriate thickness of the panel is 1 to 5 mm.

Installation

■ TERMINAL ARRANGEMENT

Bottom view: View of the Tachometer rotated horizontally 180°

Backlight Model

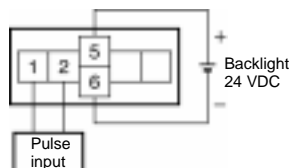

Non-backlight Model

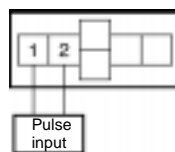

Connections

Note: Select input transistors according to the following:
 Dielectric strength of the collector \cong 50 V
 Leakage current $<$ 1 μ A

PNP/NPN UNIVERSAL DC VOLTAGE INPUT MODELS WITH BACKLIGHT

Transistor Input

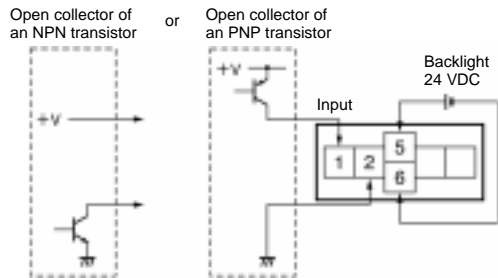

NON-VOLTAGE INPUT MODEL

Transistor Input (Open Collector of an NPN Transistor)

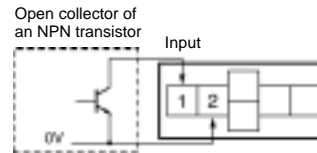

PNP/NPN UNIVERSAL DC VOLTAGE INPUT MODELS WITHOUT BACKLIGHT

Transistor Input

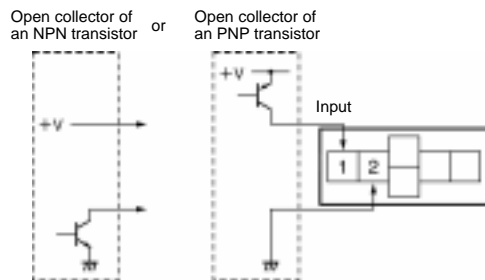

Accessories (Order Separately)

An H7ER is supplied with a mounting bracket and nut. In addition, the Flush Mounting Adapters shown here allow the H7ER to be fitted to existing panel cutouts.

Y92F-75 FLUSH MOUNTING ADAPTER FOR 26 × 45 RECTANGULAR CUTOUT

Must be used with mounting bracket supplied with the Counter

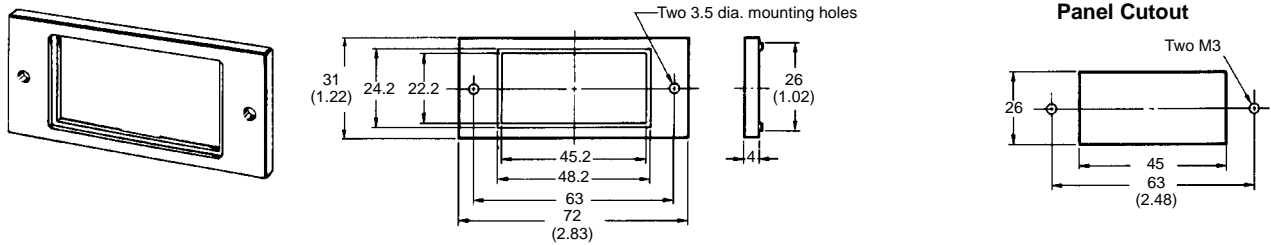

Y92F-77B FLUSH MOUNTING ADAPTER FOR 24.8 × 48.8 RECTANGULAR CUTOUT

Must be used with mounting bracket supplied with the Counter

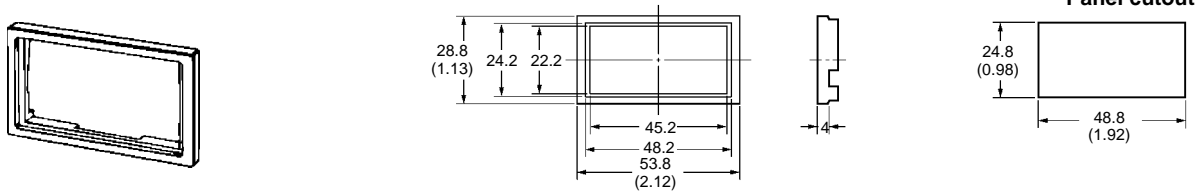

Y92S-37 WIRE-WRAP TERMINAL (SET OF TWO TERMINALS)

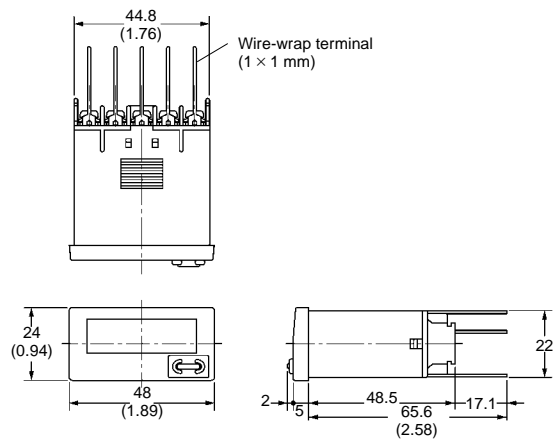
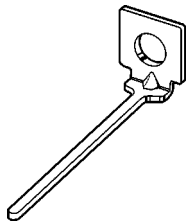

The wire-wrap terminals have a cross sectional dimension of 1x1 mm. Select one of three gauges of wire from the table at right. Also listed in the table is the appropriate wiring hardware

Wire	Bit	Sleeve	Wrapped state
AWG22	2-A	2-B	Normal
AWG24	1-A	1-B	Normal
AWG26	1-B	1-B	Normal

■ Y92S-36 REPLACEMENT (LITHIUM) BATTERY (3 V)

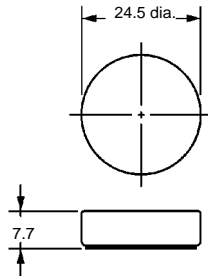
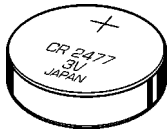

Precautions

! WARNING

This product has a built-in lithium battery. Do not short-circuit the + and - terminals, charge, disassemble, deform, or expose the battery to fire. The battery may explode (break), catch fire, or cause liquid leakage.

! Caution

Do not use any battery other than the specified one (Y92S-36). Using another battery may cause liquid leakage or breakage, resulting in malfunction or injury.

! Caution

If a voltage other than the rated one is applied, internal elements may be damaged.

Do not use the Counter in the following places:

- Locations subject to direct sunlight.
- Locations subject to corrosive gases.
- Locations subject to dust.

■ BEFORE USE

An insulation sheet has been inserted to maintain the quality of the Totalizer in the event of a long period without use. Be sure to remove this sheet before attempting to use the product.

Remove the insulation sheet and press the Reset Key on the front panel of the Counter. (With the H7ER-N, -NV(-H), -NV1(-H), models, "0" or "0.0" will be displayed after 1 s.)

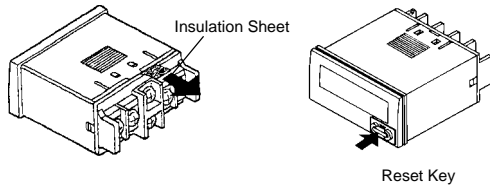

Switch settings on the Counter must be performed before mounting it to a control panel.

Do not use the Counter in locations subject to:

- Severe changes in temperature.
- Condensation as the result of high temperatures.

■ MOUNTING PRECAUTIONS FOR FLUSH MOUNTING

Although the operating section is watertight (conforming to NEMA4, IP66), rubber packing is provided to avoid water leakage through the gap between the Counter and panel cutout. Unless this rubber packing is tightly squeezed on, water may permeate inside the panel. For this reason, be sure to tighten the screws for fixing the Flush Mounting Bracket.

Screw for the Flush Mounting Bracket

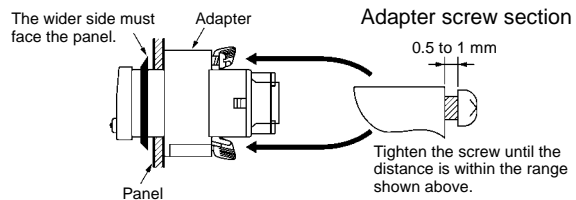

■ RESET INPUT AND COUNT INPUT

The H7ER operates using its built-in Battery. If the H7ER is connected to a device that has +V and OUT terminals connected with a diode as shown in the circuit diagram, the circuit indicated by the arrow 1 or 2 will be formed when the device is turned OFF. As a result, the H7ER may be reset or count by one. Such devices should not be connected to the H7ER.

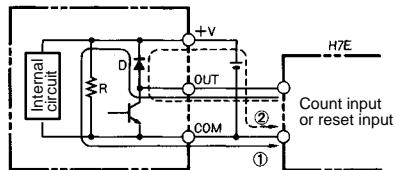

If an excessive voltage is applied to the count or reset input terminals, the internal elements may be damaged.

Ensure that the following voltages are not exceeded:

- PNP/NPN universal voltage input model: 30 VDC
- AC/DC voltage input model:
 - At count input: 240 VAC (peak voltage: 338V)
240 VDC
 - At reset input: 3 VDC (no-voltage input)
 - No-voltage input model: 3 VDC

Do not remove the outer case when voltage is being applied to the power supply terminals or to the input terminals.

The input for the H7E□-NFV-□ is a high-impedance circuit so influence from an induced voltage may result in malfunction. When the input signal wiring is longer than 10 m (stray capacitance of 120 pF/m, at room temperature), a CR filter or a bleeder resistor should be connected.

■ COUNT INPUT OR RESET INPUT TO MORE THAN ONE H7ER COUNTER AT A TIME

PNP/NPN Universal DC Voltage Input

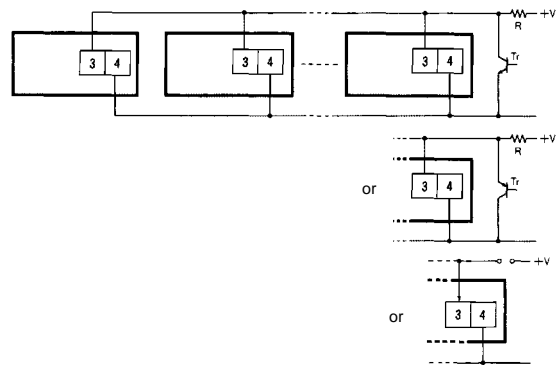

Note: H (Reset ON) level must be 4.5 V minimum.

$$H = \frac{4.7 (k\Omega)/N + V}{4.7 (k\Omega)/N + R}$$

No-voltage Input

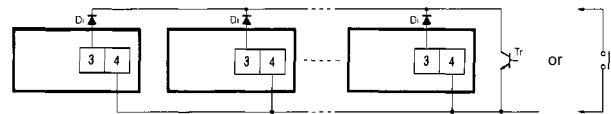

- Note:
1. The leakage current of the transistor used for input must be less than 1 μ A.
 2. The forward voltage of the diode must be as low as possible (i.e., 0.1 V maximum with an I_F of 20 μ A) so the voltage between terminals 3 and 4 will be 0.5 V when the reset input is ON.

INPUT AND POWER SUPPLY

Do not apply voltage on the Counter if the Counter is a model that operates with no-voltage input, or the internal circuit of the Counter may be damaged.

Do not connect any single input signal in parallel to Counter models operating with no-voltage input and those operating with voltage input, to avoid malfunction.

When connecting a sensor to the Counter that operates with no-voltage input, make sure that the sensor has open collector output.

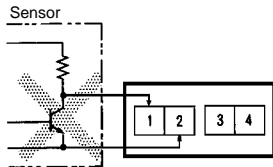

The operation of the Counter may be affected if the line voltage of the power supply exceeds 500 pF (about 10 m, with parallel wires of 2 x 2 mm). Keep all wires as short as possible. When using shielded wire, stray capacitance may occur.

When connecting an open collector input from a transistor to the Counter that operates with no-voltage input, make sure that the leakage current of the transistor is 5 μ A maximum.

When connecting count input from an SSR to the Counter that operates with AC/DC voltage input, use OMRON's G3TA-IA or G3TA-ID SSR. Make sure that the leakage current of the SSR is 0.1 mA maximum or connect a bleeder resistor in parallel to the input circuit of the Counter.

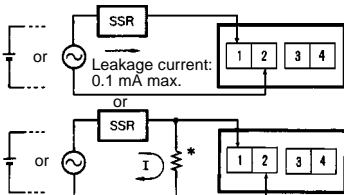

*Bleeder resistor
The voltage between terminals 1 and 2 must be 1.5 V maximum when the SSR is OFF.

BACKLIGHT POWER SUPPLY

To reduce variation in the brightness of the backlight when using more than one H7ER with a backlight, use the same power supply for all the backlights.

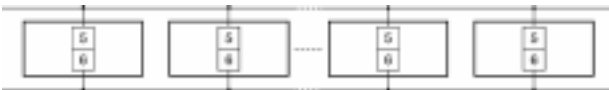

When connecting the DC power supply for the backlights, be sure to connect the polarities correctly.

UNIT LABEL FOR TIME COUNTER AND TACHOMETER

A unit label has been packed with the Counter. Use in accordance with the application.

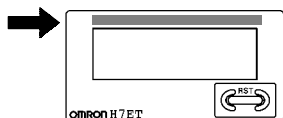

BATTERY REPLACEMENT

Remove the wiring when replacing the Battery. Do not come in contact with any item to which high voltage is being applied. Doing so may result in electric shock.

Before changing the Battery, be sure that you are not carrying any static electric charge.

Procedure for replacing the Battery (refer to the diagrams below):

1. Using the tool, pry open the lift-tab on the case. (1)
2. Pull the body out of its outer case. (2)
3. Lift the Battery up by the edge and remove it. (3)
When removing the Battery, do not come in contact with the display area or any internal parts.
4. Wipe the back of the new Battery before inserting it.
5. Ensure that the + and - terminals are correctly oriented.
6. After replacing the Battery, re-insert the body into its case. (4)
Check that the case is securely held in by the lift-tab.
7. Press the Reset Key before use (not necessary for H7ER-N,-NV,-NV1). (5)

When the internal Battery nears expiration, the display may flicker.

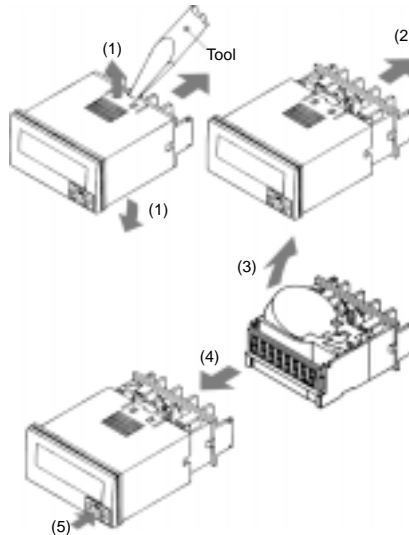

EN/IEC STANDARDS

The counter input, reset input, and backlight power supply terminals of the no-voltage input or PNP/NPN universal DC voltage input models (H7E□-N,-N1, H7E□-NV(-H),-NV1(-H)) are not isolated.

A SELV power supply conforming to Appendix H of IEC61010-1 should be used for the counter input, reset input and backlight power supply terminals. A SELV power supply is a power supply for which the input and output have double or reinforced insulation, and for which the output voltage is 30 Vrms with 42.4 V peak or 60 VDC max. (Only the H7E□-NV□-H has a backlight.)

The terminals for counter input and reset input for AC/DC multi-voltage input models have basic insulation.

Connect the reset input terminals to a device that does not have exposed current-carrying parts and has basic insulation for 240 VAC.

NOTE: DIMENSIONS SHOWN ARE IN MILLIMETERS. To convert millimeters to inches divide by 25.4.

OMRON®
OMRON ELECTRONICS, INC.
One East Commerce Drive
Schaumburg, IL 60173
1-800-55-OMRON

OMRON CANADA, INC.
885 Milner Avenue
Scarborough, Ontario M1B 5V8
416-286-6465

X-ON Electronics

Largest Supplier of Electrical and Electronic Components

Click to view similar products for [Counters & Tachometers](#) category:

Click to view products by [Omron](#) manufacturer:

Other Similar products are found below :

[LC2H-FE-2K-N](#) [SM155115300](#) [LC24-F-N](#) [81333-26](#) [H7ER-NV1-H](#) [P8-4906](#) [GPMZC-SET](#) [SM1557242K](#) [SM155724300](#) [26546848](#) [P2-4904](#) [1-4615](#) [1-4625](#) [1-4635](#) [1.230.301.038](#) [6.924.0101.3A0](#) [H7CX-A-N](#) [P8-4904](#) [SLC-30 R48](#) [7000](#) [7000AS](#) [7922](#) [8980-1](#) [9100](#)
[H127.010A01H](#) [H5KLR-11](#) [100-240V AC/DC](#) [H7CX-AUD1-N](#) [H7CX-AW-N](#) [3.550.401.075](#) [3.550.401.351](#) [LC2H-C-2K-N](#) [LC2H-C-30-N](#)
[LC4H-R4-AC240VS](#) [LC4H-R6-AC240V](#) [1.150.510.012.550](#) [1.150.510.013.550](#) [1.150.510.054.550](#) [6.520.012.300](#) [6.560.010.300](#) [SLE-73-1400-1-4-01](#) [SLIK-94-1521-1-3-001](#) [SLN-94-1421-1-3](#) [6.924.0103.300](#) [SPI-73-1411-1-3-011](#) [SPI-73-1411-1-4-011](#) [CT6S-1P4](#) [Y-50](#) [LC4H-R4-AC24V](#) [LC4H-R4-DC24V](#) [CT6S-2P4](#)