

# Thermal overload relay J7TC Series

**Motor Protection from Overload and Phase -loss by Combination with J7KC for up to 2.2 kW (240 VAC) \*, 5.5 kW (440 VAC)**



- Push-In Plus wiring Technology saves Wiring and Maintenance time
- One-touch Installation with magnetic contactor J7KC to configure a magnetic starter
- High-reliability auxiliary circuit (2PST-1NO 1NC)
- Equipped with a dial cover as standard to suppress setting changes
- Easily switch between manual and automatic reset methods
- Certified as compliant with the main safety standards

\* Based on JIS C 8201-4-1

For the most recent information on models that have been certified for safety standards, refer to your OMRON website.

Refer to *Safety Precautions* on page Page 9.

## Model Number Structure

**Model Number Legend** Order according to the format described in Ordering Information.

**J7TC- 01 - □□□**  
For J7KC (1)

(1) Trip current

Code	Settling current range
E15	0.1-0.15 A
E20	0.13-0.2 A
E27	0.18-0.27 A
E36	0.24-0.36 A
E52	0.34-0.52 A
E72	0.48-0.72 A
E96	0.64-0.96 A
1E2	0.8-1.2 A
1E4	0.95-1.45 A
1E6	1.1-1.65 A

Code	Settling current range
2E1	1.4-2.1 A
2E6	1.7-2.6 A
3E4	2.2-3.4 A
4E2	2.8-4.2 A
6	4-6 A
7E5	5-7.5 A
9	6-9 A
10	7-10.5 A
13	9-13 A

# J7TC Series

## Ordering Information

---

### Main unit

#### Thermal overload relay

Settling current range	Model
0.1-0.15 A	J7TC-01-E15
0.13-0.2 A	J7TC-01-E20
0.18-0.27 A	J7TC-01-E27
0.24-0.36 A	J7TC-01-E36
0.34-0.52 A	J7TC-01-E52
0.48-0.72 A	J7TC-01-E72
0.64-0.96 A	J7TC-01-E96
0.8-1.2 A	J7TC-01-1E2
0.95-1.45 A	J7TC-01-1E4
1.1-1.65 A	J7TC-01-1E6
1.4-2.1 A	J7TC-01-2E1
1.7-2.6 A	J7TC-01-2E6
2.2-3.4 A	J7TC-01-3E4
2.8-4.2 A	J7TC-01-4E2
4-6 A	J7TC-01-6
5-7.5 A	J7TC-01-7E5
6-9 A	J7TC-01-9
7-10.5 A	J7TC-01-10
9-13 A	J7TC-01-13

### Accessories (Order Separately)

#### Insulation stop

Model	Minimum order (bag)
J77KC-T (for main circuit)	1
J77KC-K (for auxiliary circuit)	(30 pcs./bag)

#### Removal tool

Model
J78KC

# Ratings/Specifications

## Ratings/Specifications

Main circuit rating	Trip class		10 A						
	3-pole load operation (At 20°C ambient temperature) IEC 60947-4-1/ JIS C 8201-4-1	Limit operation	No operation (cold start)	105% (less than 2 hours) *1					
			Operation (hot start)	120% (less than 2 hours) *1					
		Operation when overload occurs (hot start)		150% (less than 2 minutes) *1					
		Operation when locking occurs (cold start)		720% (over 2 s up to 10 s) *1					
	2-pole load operation (At 20°C ambient temperature) IEC 60947-4-1/ JIS C 8201-4-1	Phase less protection device		With phase failure protection device					
		No operation (cold start)		2 poles 100%/1 pole 90% *1					
		Operation (hot start)		2 poles 115%/1 pole 0% (less than 2 hours) *1					
	Ambient temperature compensation performance	Ambient temperature 40°C	No operation (cold start)	100% (less than 2 hours) *1					
			Operation (hot start)	120% (less than 2 hours) *1					
Ambient temperature -5°C		No operation (cold start)	105% (less than 2 hours) *1						
		Operation (hot start)	130% (less than 2 hours) *1						
Auxiliary circuit rating	Ratings based on IEC 60947-5-1	Rated voltage range (V)		24	100-120	200-240	380-440	500-600	
		Rated operational current (A)	AC-15 (Coil load)	NC contact	3.0 (0.5) *2	2.5 (0.5) *2	2.0 (0.5) *2	1.0 (0.5) *2	0.6 (0.5) *2
				NO contact	3.0 (0.5) *2	2.5 (0.5) *2	1.5 (0.5) *2	0.75 (0.5) *2	0.6 (0.5) *2
		DC-13 (Coil load)	NC contact	1.1 (0.3) *2	0.28	0.14	---	---	
			NO contact	1.1 (0.3) *2	0.28	0.14	---	---	
	Conventional free air thermal current (Rated carry current)		5 A						
	Ratings based on UL 508	Rated carry current (A)		5				1	
		Rated voltage (V)		120 AC	240 AC	480 AC	600 AC	125 DC	250 DC
		Contact closed current (A)		30	15	7.5	6	0.22	0.11
		Breaking current (A)		3	1.5	0.75	0.6	0.22	0.11
		Rating code		B600				Q300	
	Minimum operate voltage/current (reference value)		5 VDC, 3 mA						
	Contact resistance (reference value)		50 mΩ max. (6 VDC, 1 A, voltage drop method)						
	Contact structure		Single-break						
	Contact material		Ag alloy						
Rated insulation voltage		690VAC							
Rated impulse dielectric strength		6 kV							
Rated frequency		50/60 Hz							
Vibration resistance		Vibration: 10 to 55 Hz, acceleration: 15m/s <sup>2</sup>							
Shock resistance		Shock value 50 m/s <sup>2</sup>							
Degree of protection		IP20 (IEC60529)							
Operating temperature		-10 to +55°C (however, daily average shall not exceed 35°C)							
Ambient storage temperature		-40 to +65°C (no condensation or icing)							
Relative humidity		45% to 85% RH (no condensation or icing)							
Altitude		2000 m max.							
Weight		110 g							
Applicable standards		Safety standard EN 60947-4-1 (IEC 60947-4-1), UL 60947-4-1, CSA 22.2 No.60947-4-1, CCC GB/T 14048.4							

\*1. Ratio to dial settling current

\*2. ( ) indicates the contact rating when set to auto release

# J7TC Series

## Engineering Data

### Operating characteristics curves

Trip class 10 A

Cold-start characteristics (20°C ambient temperature)

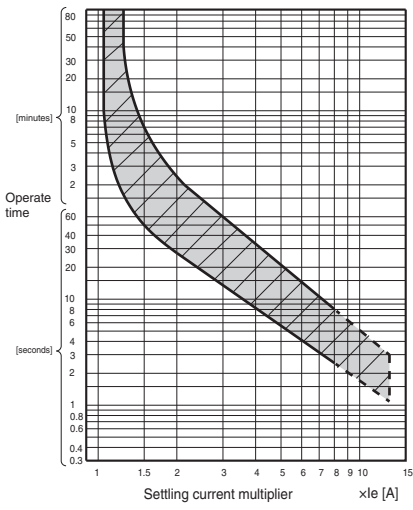

Hot-start characteristics (20°C ambient temperature)

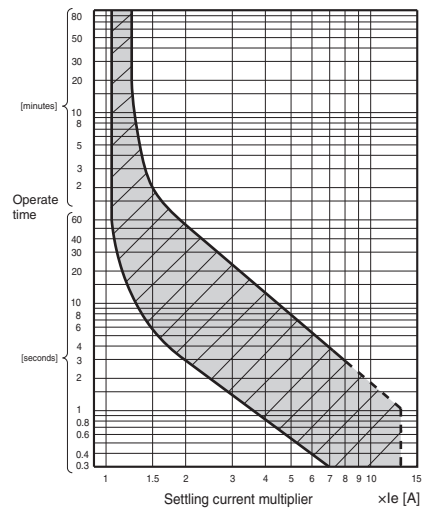

(Average values) (Ambient temperature 20°C)

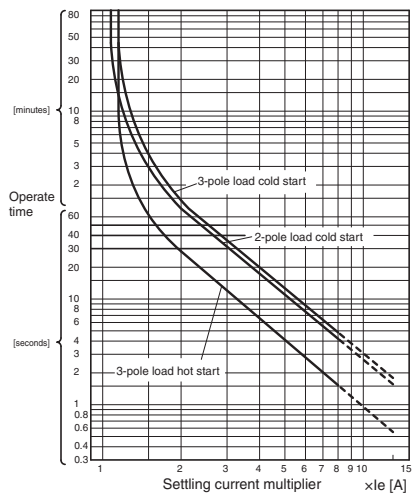

# Nomenclature

## J7TC

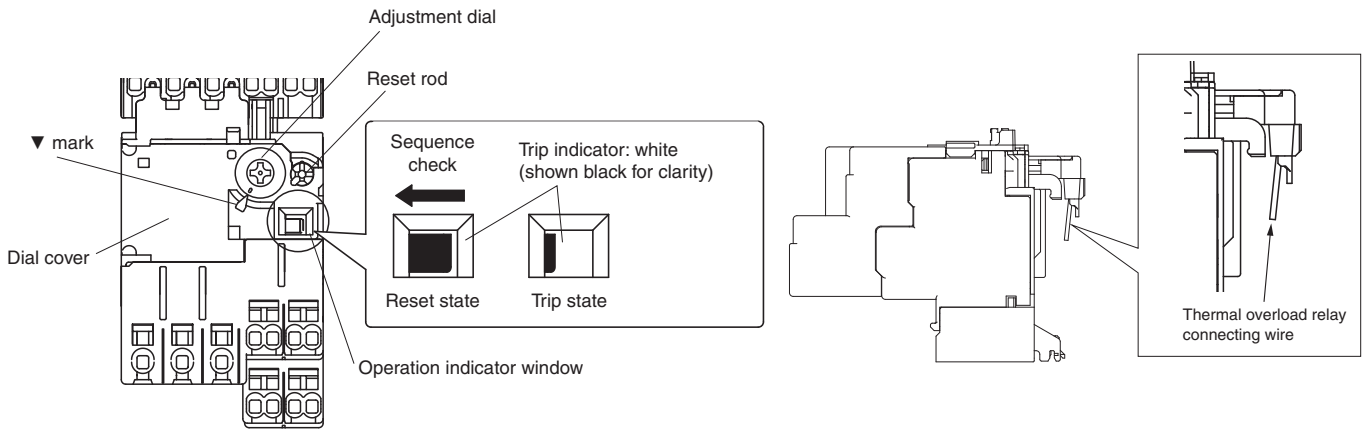

# Dimensions

(Units: mm)

## Main unit

### J7TC

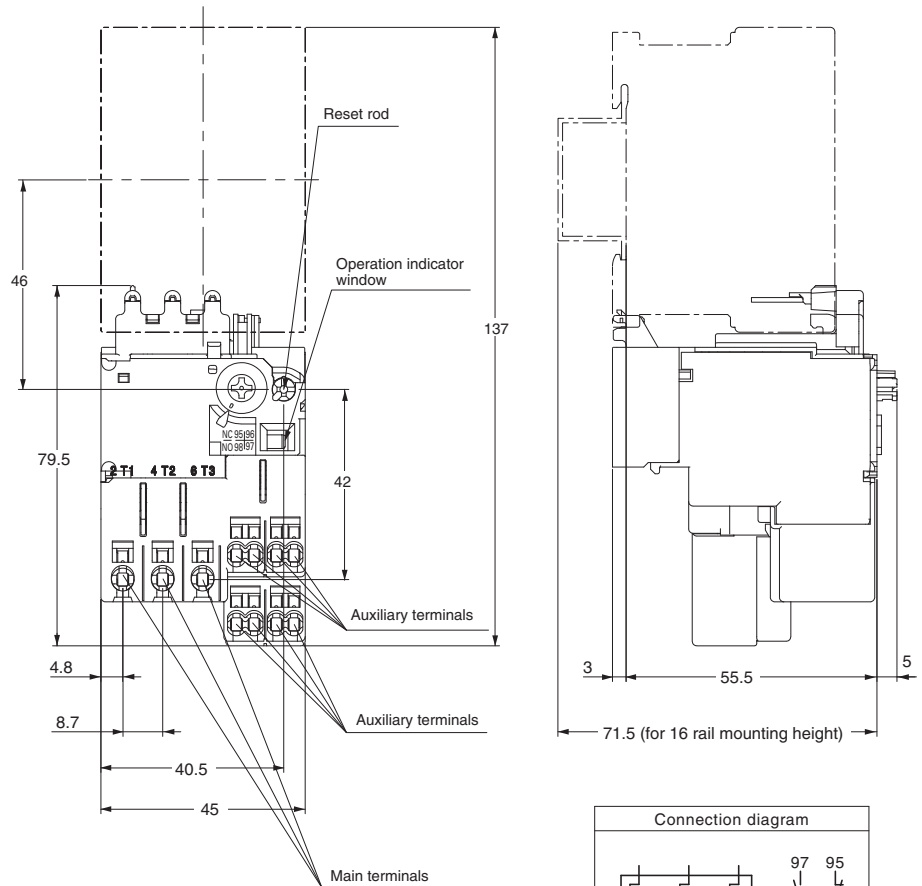

# J7TC Series

## Related Products (Order Separately)

### Magnetic contactor J7KC



J7KC

+



J7TC

=



Magnetic starters

When using a thermal overload relay, combine it with a magnetic contactor to use it as a magnetic switch.

## Coordination with the short circuit protection device (SCPD) (based on IEC and JIS standards)

Assumed short circuit current "r" (240 V, 440 V)

Magnetic starters			Coordination type				
Magnetic contactor	Thermal overload relay		Type 1			Type 2	
	Setting current range [A]	Short-circuit current "r" [kA]	Breaker EN60947-2	Rating [A]	Short-circuit current "r" [kA]	Fuse rating [A] (IEC 60269-1 gG and gM)	
J7KC-12	J7TC-01	0.34-0.52	1	Breaker for wiring protection (MCCB) Icu 240 V 5 kA 440 V 2.5 kA	3	1	2
		0.48-0.72			5		4
		0.64-0.96			10		16
		0.8-1.2			20		
		0.95-1.45					
		1.1-1.65					
		1.4-2.1					
		1.7-2.6					
		2.2-3.4					
		2.8-4.2					
		4-6					
		5-7.5					
		6-9			30		
7-10.5							
9-13							

## Conditional rated short circuit current Iq (240 V)

Magnetic starters			Coordination type					
Magnetic contactor	Thermal overload relay		Type 1			Type 2		
	Setting current range [A]	Short-circuit current "Iq" [kA]	Breaker EN60947-2	Rating [A]	Short-circuit current "Iq" [kA]	Fuse rating [A] (IEC 60269-1 gG and gM)		
J7KC-12	J7TC-01	0.34-0.52	25	Breaker for wiring protection (MCCB) Icu 240 V 5 kA 440 V 2.5 kA	3	50	2	
		0.48-0.72			5		4	
		0.64-0.96			10		16	
		0.8-1.2						20
		0.95-1.45						
		1.1-1.65						
		1.4-2.1						
		1.7-2.6						
		2.2-3.4						
		2.8-4.2						
		4-6						
		5-7.5						
		6-9			30		20	
7-10.5								
9-13								

Options (order separately)

(Unit: mm)

Insulation stop

For main circuit

J77KC-T



For auxiliary circuit

J77KC-K



Guide for insertion into terminal (insertion) holes to stabilize holding of 1mm<sup>2</sup> or less stranded wire (direct insertion).

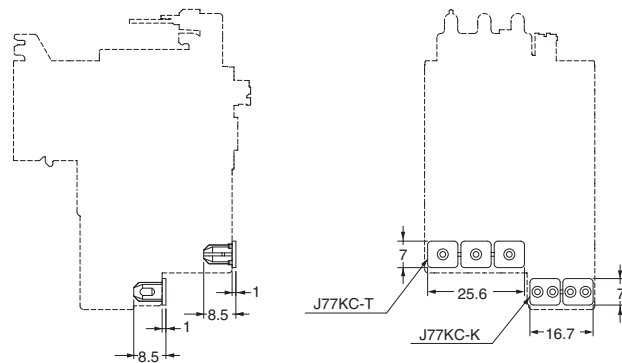

Removal tool

J78KC

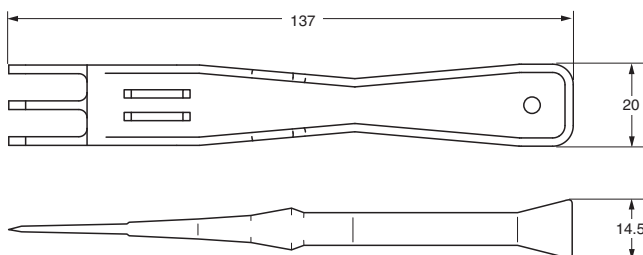

# J7TC Series

## DIN Rails (Order Separately)

(Unit: mm)

### Mounting Rail PFP-100N PFP-50N

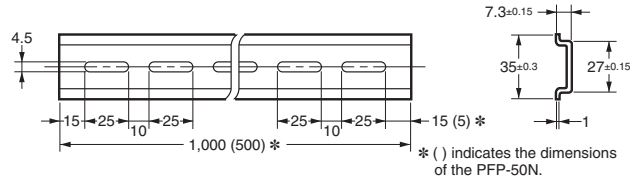
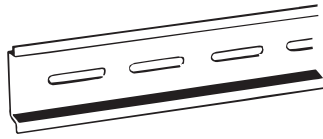

Model
PFP-100N
PFP-50N

### Mounting Rail PFP-100N2

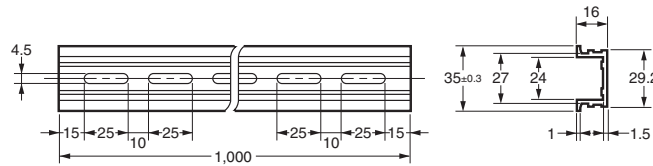
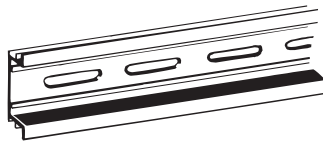

Model
PFP-100N2

### End Plate PFP-M

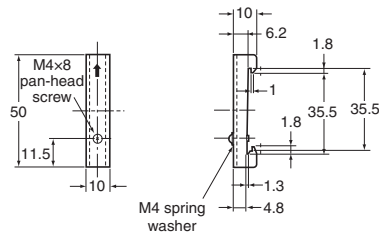
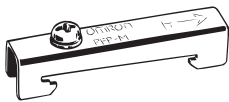

Model
PFP-M

### Spacer PFP-S

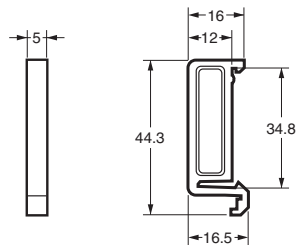
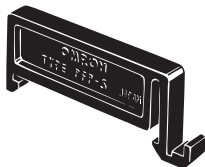

Model
PFP-S

**Note:** 1. Order the parts above in units of ten. The prices shown above are standard prices for one piece.  
2. Rails conform to DIN standards.







## Safety Precautions

### Warning Indications

 <b>CAUTION</b>	Indicates a potentially hazardous situation which, if not avoided, is likely to result in minor or moderate injury or property damage.
<b>Precautions for Safe Use</b>	Supplementary comments on what to do or avoid doing, to use the product safely.
<b>Precautions for Correct Use</b>	Supplementary comments on what to do or avoid doing to prevent failure to operate, malfunction, or undesirable effects on product performance.

### Meaning of Product Safety Symbols

	Used to warn of the risk of electric shock under specific conditions.
	Used to indicate prohibition when there is a risk of minor injury from electric shock or other source if the product is disassembled.
	Used for general prohibitions for which there is no specific symbol.
	Used for general mandatory action precautions for which there is no specified symbol.

### **CAUTION**

**Do not touch or approach the product while or immediately after power is supplied. This may result in electric shock or burn injuries.**



**Minor electric shock, fire, or malfunction may occasionally occur. Never disassemble, modify, or repair the product or touch any of the internal parts.**



**Do not use the product in an environment where flammable or explosive gas is present.**



**When replacing the magnetic contactor, also replace the thermal overload relay at the same time.**



### Precautions for Safe Use

- Do not use the product in any of the following locations.
  - Places subject to intense temperature changes.
  - Places subject to high humidity or condensation.
  - Places subject to intense vibration or shock.
  - Places subject to considerable dust or corrosive gas, or directly exposed to sunlight.
  - Places subject to splashing water, oil, or chemicals.
- Do not store or use in conditions that subject the product to an external load.
- Install securely on the magnetic contactor.
- Never drop the product or allow it to fall.
- Make sure that foreign matter does not collect or enter into the terminal (insertion) hole or release hole. Smoking or ignition, malfunctioning, or failure may occur.
- Do not use the product at less than the minimum applicable load.
- Never use at a load that exceeds the rated capacity.
- If the circuit is a two-wire circuit and auto reset takes place, the motor will automatically restart when the thermal relay automatically resets. Exercise caution.
- Use wire, ferrules, and tools with the required specifications. Strip the wires to the specified length, and use ferrules of the specified length. Fully insert them to the back of the terminal (insertion) holes. (For details, refer to the information on pages 13 and 14.)
- If directly inserting wire, always use tin-plated strand wire.
- Do not insert multiple wires into one terminal (insertion) hole.
- Do not wire terminals that are not used.
- Make sure all wiring connections are correct before supplying power.
- Do not accidentally insert a wire into the release hole.
- Do not bend a wire past its natural bending radius or pull on it with excessive force.
- After inserting the tool into the release hole, do not pry with the tool.
- Do not insert the tool into the terminal (insertion) hole.
- Do not supply power while the tool is inserted into the release hole.
- Do not insert anything other than the specified tool into the release hole.
- Wipe off any dirt from the product with a soft dry cloth. Never use thinners, benzene, alcohol, or any cleaners that contain these or other organic solvents. Deformation or discoloration may occur.
- When disposing of the product, follow local disposal procedures for industrial waste.

### Precautions for Correct Use

- Avoid use in a location with many magnetic particles. Risk of failure.

## Mounting, removal, setting, and wiring (connection)

### Installing the thermal overload relay

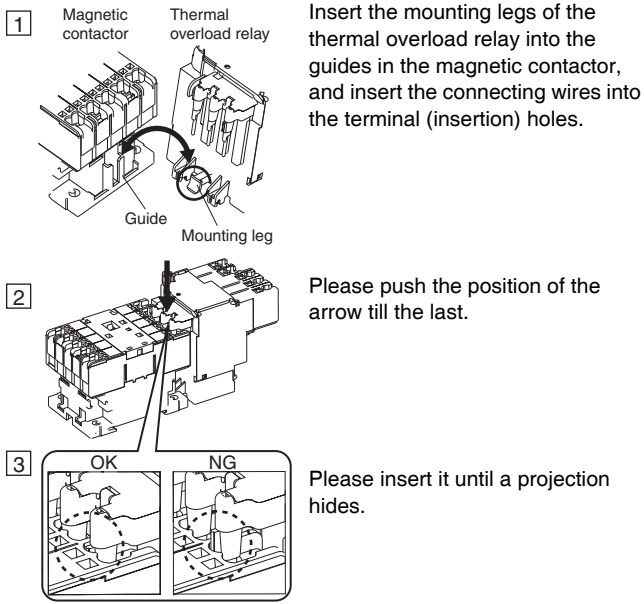

Insert the mounting legs of the thermal overload relay into the guides in the magnetic contactor, and insert the connecting wires into the terminal (insertion) holes.

Please push the position of the arrow till the last.

Please insert it until a projection hides.

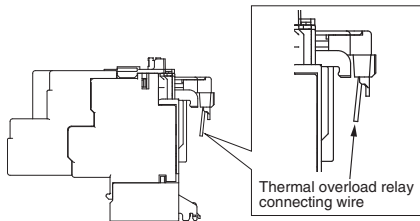

- \* The connecting wires are manufactured at an angle. Be sure not to change the shape of the connection terminals.
- \* Thermal overload relays cannot be used for auxiliary relays.

### Mounting on rail

Follow the procedures below to mount the product on the rail or remove it from the rail.

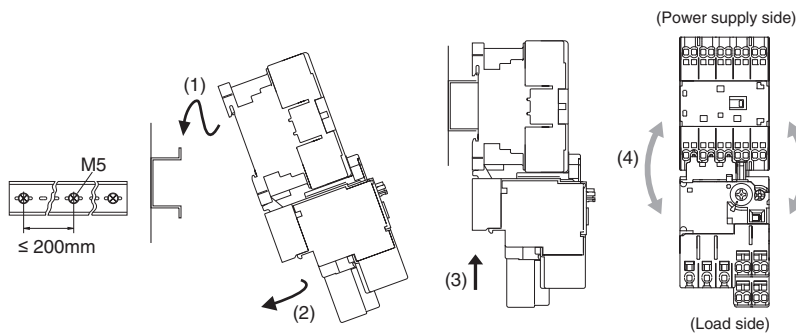

When mounting on a rail, use the end plate.

### Removing from rail

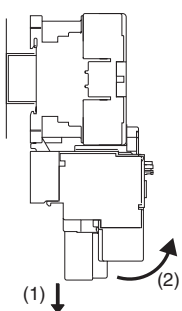

- (1) Hold the product at the top and bottom. Push it downward to release the lower hook.
- (2) Remove the product.

### Removing of the thermal overload relay

Follow the procedure below to remove the thermal overload relay with the removal tool (J78KC).

- (1) Insert the removal tool into the release hole.
- (2) Pull out the thermal overload relay in the direction of the arrow while the removal tool is still inserted.
- (3) Pull out the removal tool.

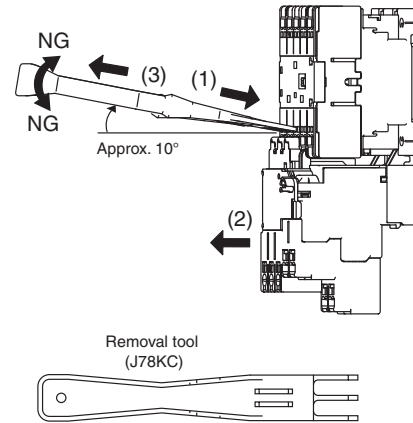

### Installation interval

Mount with a separation of at least the dimension shown in the diagram.  
 When mounting J7TC units close together, there are no restrictions specifically for the J7TC.  
 Follow the instructions for the J7KC that is the mounting base.

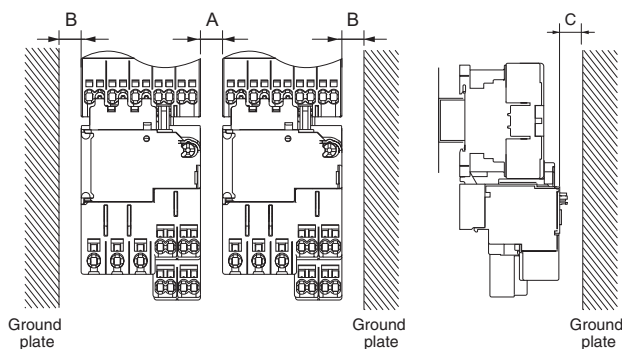

A [mm]	B [mm]	C [mm]
5	10	*

\* Set dimension C to an adequate distance for wiring. If the wires have to be bent in a small space, check the minimum bending dimensions with the wire manufacturer before connecting the wiring.

### Mounting angle

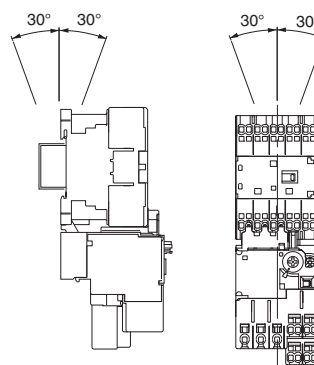

### Setting up the thermal overload relay

#### (1) Current settling [Fig. 1]

Turn the adjustment dial within the scale range to align the motor full-load current to the ▼ mark. Full performance may not be achieved if used outside the scale range. Also, if the thermal overload relay operates unnecessarily at startup due to the type of motor used, increase the settling current value by up to 5% on the dial. Take due care. The motor may not be properly protected if the value is increased too high.

#### (2) Operation indicator [Fig. 1]

When the thermal overload relay is activated, the white trip indicator is hidden in the operation indicator window.  
 (If the relay is activated during an auto reset after it tripped, the white trip indicator is not hidden.)

#### (3) Sequence check [Fig. 1]

Move the white trip indicator in the direction of the arrow to run a sequence check.

#### (4) Reset method [Fig. 1]

If the thermal overload relay has been activated, eliminate the overload or other cause of abnormality and then push the reset rod. Push the reset rod in as far as possible. (In this case, the thermal overload relay can only be reset after it cools sufficiently.)

#### (5) Auto reset state and two-wire circuit

If the circuit is a two-wire circuit and auto reset takes place, the motor will automatically restart when the thermal relay automatically resets.  
 Exercise caution.

#### (6) How to switch from manual reset to auto reset [Fig. 2]

Follow the procedure below to switch from manual reset to auto reset.  
 Reverse the procedure to switch back from auto reset to manual reset.

- (1) Open the front cover.
- (2) Hold down the reset rod with a screwdriver and turn it 90 degrees clockwise.
- (3) Make sure that the reset rod is held in the pushed-down position.
- (4) Close the front cover.

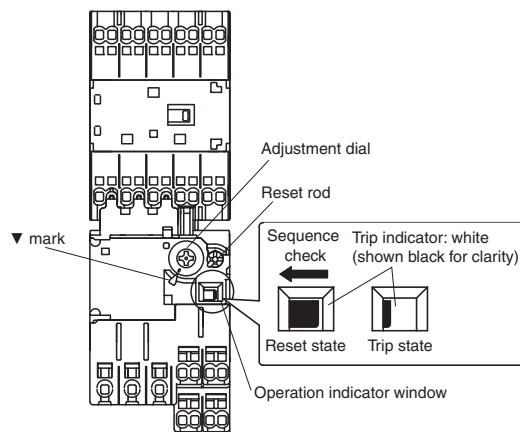

Fig. 1

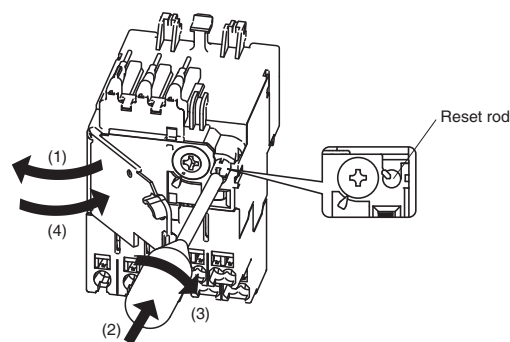
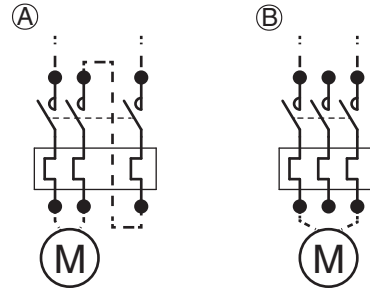

Fig. 2

## Application to single-phase or DC motor

As the thermal relay is equipped with a phase failure protection function as standard, if all phases are not energized, the operating current may be low and unnecessary operation may occur. Perform either (A) or (B) when applying the product to single-phase motor circuits or DC circuits.

- (A) Connect the wires so that all poles can be energized in series.
- (B) Set the adjustment dial to an approximately 10% higher value.



## Ambient temperature compensation characteristics

Correction of the settling current value according to the operating environment may be required, as the operating current becomes high on the low-temperature side and low on the high-temperature side due to fluctuations in ambient temperature around the thermal overload relay, so that compensation of the operating characteristics tends to be inadequate.

Fig. 3 shows the approximate correction factor for correcting the settling current value according to the ambient temperature.

If the actual ambient temperature differs significantly from 20°C, calculate the corrected settling current value as shown in the example below.

[Example] Calculating the dial settling current value at 55°C ambient temperature

$$\frac{\text{Dial settling current value at } 20^{\circ}\text{C}}{\text{Correction factor for } 55^{\circ}\text{C}} = \text{Dial settling current value at } 55^{\circ}\text{C ambient temperature}$$

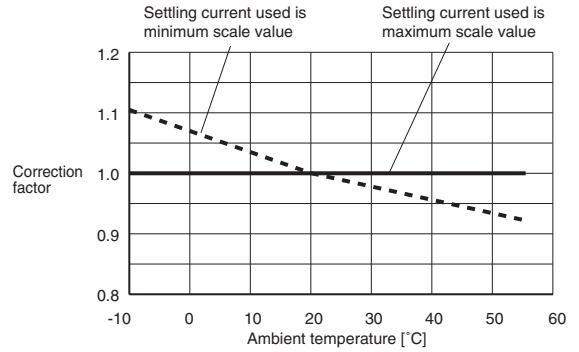
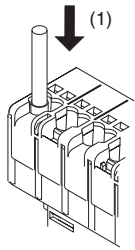

Fig. 3

## Wiring

### Wire with ferrule



- (1) Insert straight in until the ferrule contacts the terminal block.
- (2) After inserting, pull the wire lightly and check the connection.

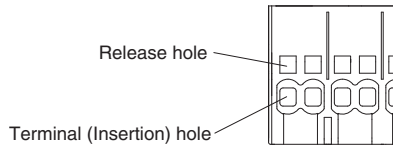

### Stranded wire (direct insertion)

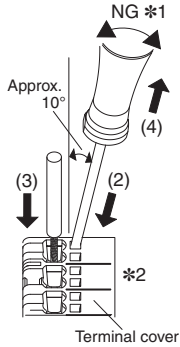

- (1) Before inserting, twist the core wire of the electric wire.
- (2) Insert the recommended tool straight at about 10° angle in the direction of the arrow, into the terminal block until the end touches the release hole.
- (3) With the tool inserted in the release hole, insert straight in until the wire contacts the terminal block.
- (4) Remove the tool from the release hole.
- (5) After inserting, pull the wire lightly and check the connection.

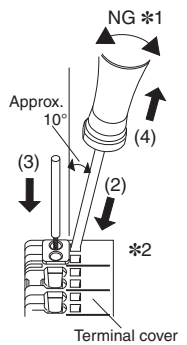

- \* When using an insulation stop After inserting the insulation stop into the terminal (insertion) hole all the way to the base, perform steps (1) to (5). The insulation stop will insert easily if you insert at a slight angle to the terminal (insertion) hole and twist as you press it in.
- \*1. Do not prying by the tool.
- \*2. If the terminal cover comes off because you pried with the tool, do not reuse it.

### Removing wire

#### Common for electric wires with ferrules and stranded wires (direct wiring)

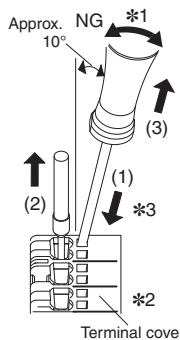

- (1) Insert the recommended tool straight at about 10° angle in the direction of the arrow, into the terminal block until the end touches the release hole.
- (2) With the tool still inserted into the release hole, remove the wire from the terminal insertion hole.
- (3) Remove the tool from the release hole.

- \*1. Do not prying by the tool.
- \*2. If the terminal cover comes off because you pried with the tool, do not reuse it.
- \*3. The inside of the release hole is electrically live. Electric shock may result. Do not use a screwdriver with a metal handle. Do not touch the metal part of the tool.

### Connection method and application size of the electric wire

- If directly inserting wire, always use tin-plated strand wire.
- Crimp the ferrule for stranded wires that are not tin plated.
- Solid wire and bar terminals cannot be used.

### Applicable wire sizes

Applicable wire		Ferrules used				Stranded wires (direct insertion) *4		
		With an insulation sleeve (L = 8 mm, 10 mm)		Without an insulation sleeve (L=10 mm)				
(mm <sup>2</sup> )	(AWG)	Size (mm <sup>2</sup> )	Main circuit	Auxiliary circuit	Main circuit	Auxiliary circuit	Main circuit	Auxiliary circuit
0.5	20	0.5	---	⊙	---	⊙	---	⊙ (v)
0.75	18	0.75	⊙	⊙	⊙	⊙	⊙	⊙
1		1	⊙	⊙	⊙	⊙	⊙	(*3) (*3)
1.25	16	1.5	⊙	⊙	⊙	⊙	⊙	⊙
1.5		1.5	⊙	⊙	⊙	⊙	⊙	⊙
2	14	2 (*2)	⊙	⊙	⊙	⊙	⊙	---
2.5		2.5	---	---	⊙	⊙	⊙	---

⊙: 2 wires allowed (simultaneous connection for crossover wiring terminals),  
 ○: 1 wire allowed, ---: out of specification

\*1. For compliance with UL or CSA standards, you must use wires of the following sizes.

Main circuit: 14AWG

Auxiliary circuit: 16AWG to 14 AWG

\*2. Connection is only possible using 2 mm<sup>2</sup> FE-2.08-8N-YE and FE-2.08-10N-YE ferrules with insulation sleeves manufactured by Wago.

\*3. Use insulation stops.

Insulation stops cannot be used with ferrules.

Do not use insulation stops in empty terminals.

\*4. Insulation stripping length for stranded wires (direct insertion) is as follows.

0.5 mm<sup>2</sup> to 1.0 mm<sup>2</sup> (20AWG to 18AWG): 12 mm ± 1 mm

1.25 mm<sup>2</sup> to 2.5 mm<sup>2</sup> (16AWG to 14AWG): 11 mm ± 1 mm

When using ferrules, refer to the table of recommended ferrules.

## Recommended Ferrules and Crimp Tools

### Recommended ferrules

Applicable wire		Ferrule conductor length (mm)	Recommended ferrules							
(mm <sup>2</sup> )	(AWG)		With an insulation sleeve				Without an insulation sleeve			
		Insulation stripping length (mm)	Phoenix Contact	Weidmuller	Wago	Insulation stripping length (mm)	Phoenix Contact	Weidmuller	Wago	
0.5	20	8	10	Al 0,5-8	H0.5/14	FE-0.5-8N-WH	---	---	---	---
		10	12	Al 0,5-10	H0.5/16	FE-0.5-10N-WH	10	A 0,5-10	H0.5/10	F-0.5-10
0.75	18	8	10	Al 0,75-8	H0.75/14	FE-0.75-8N-GY	---	---	---	---
		10	12	Al 0,75-10	H0.75/16	FE-0.75-10N-GY	10	A 0,75-10	H0.75/10	F-0.75-10
1/1.25	18/17	8	10	Al 1-8	H1.0/14	FE-1.0-8N-RD	---	---	---	---
		10	12	Al 1-10	H1.0/16	FE-1.0-10N-RD	10	A 1-10	H1.0/10	F-1.0-10
1.25/1.5	17/16	8	10	Al 1,5-8	H1.5/14	FE-1.5-8N-BK	---	---	---	---
		10	12	Al 1,5-10	H1.5/16	FE-1.5-10N-BK	10	A 1,5-10	H1.5/10	F-1.5-10
2	14	8	10	Al 2,5-8	H2.5/15D	FE-2.08-8N-YE	---	---	---	---
						FE-2.5-8N-BU	---	---	---	---
		10	12	Al 2,5-10	---	FE-2.08-10N-YE	10	---	H2.5/10	F-2.5-10
2.5	14	10	12	---	---	---	10	---	H2.5/10	F-2.5-10
		12	14	---	---	---	---	---	---	---
Recommended crimp tool				CRIMPFOX 6 CRIMPFOX 6T-F CRIMPFOX 10S	PZ6 roto	Variocrimp4	---	CRIMPFOX 6 CRIMPFOX 6T-F CRIMPFOX 10S	PZ6 roto	Variocrimp4

\* Make sure that the outer diameter of the wire coating is smaller than the inner diameter of the insulation sleeve of the recommended ferrule.

### Ferrule processing dimensions

Dimension (after processing)	Main circuit		Auxiliary circuit		
	Minimum	Maximum	Minimum	Maximum	
L [mm]	0	0.5	0	0.5	
D [mm]	Less than 2.5		Less than 2.5		
Wire size	[mm <sup>2</sup> ]	0.75	2	0.5	1.5
	[AWG]	18	14	20	16

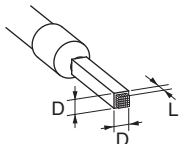

### Recommended flat-bladed screwdriver (Recommended tool)

Use a flat-blade screwdriver to connect and remove wires.

Use the flat-blade screwdriver shown in the table below.

The following table shows manufacturers and models as of 2018/Dec.

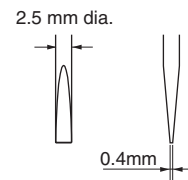

Model	Manufacturer
ESD 0,40x2,5	Wera
SZS 0,4x2,5	Phoenix Contact
SZF 0-0,4x2,5*	
0.4x2.5x75 302	Wiha
AEF.2,5x75	Facom
210-719	Wago
SDIS 0.4x2.5x75	Weidmuller
9900 (-2.5x75)	Vessel

\* OMRON's exclusive purchase model XW4Z-00B is available to order as SZF 0-0,4x2,5 (manufactured by Phoenix Contact).

### Electrical detection

Electricity can be detected by inserting a detector in the release hole.

When inserting a detector, insert it gently while checking for electrical signals. The wire may pull out if the detector is fully inserted.

After detection is complete, immediately pull out the detector and check that the wire is still firmly connected.

### Recommended replacement period

Magnetic contactors and switches have a wear life according to the number of switching cycles of their main contacts and mechanical parts. The coil wiring and electronic parts in the electronic unit have a service life resulting from deterioration due to the operating environment and conditions.

You are recommended to replace magnetic contactors and switches after the rated number of switching cycles specified in the catalog, or 10 years after the date of manufacture according to the standard conditions of operation described in the "Survey on Low-voltage Equipment Update Recommendation Times" report prepared by the Japan Electrical Manufacturers' Association (JEMA).

**OMRON AUTOMATION AMERICAS HEADQUARTERS** • Chicago, IL USA • 847.843.7900 • 800.556.6766 • automation.omron.com

**OMRON CANADA, INC. • HEAD OFFICE**

Toronto, ON, Canada • 416.286.6465 • 866.986.6766 • automation.omron.com

**OMRON ELECTRONICS DE MEXICO • HEAD OFFICE**

Ciudad de México • 52.55.5901.4300 • 01.800.386.6766 • mela@omron.com

**OMRON ELECTRONICS DE MEXICO • SALES OFFICE**

San Pedro Garza García, N.L. • 81.12.53.7392 • 01.800.386.6766 • mela@omron.com

**OMRON ELECTRONICS DE MEXICO • SALES OFFICE**

Eugenio Garza Sada, León, Gto • 01.800.386.6766 • mela@omron.com

**OMRON ELETRÔNICA DO BRASIL LTDA • HEAD OFFICE**

São Paulo, SP, Brasil • 55.11.2101.6300 • www.omron.com.br

**OMRON ARGENTINA • SALES OFFICE**

Buenos Aires, Argentina • +54.11.4521.8630 • +54.11.4523.8483  
mela@omron.com

**OTHER OMRON LATIN AMERICA SALES**

+54.11.4521.8630 • +54.11.4523.8483 • mela@omron.com

*Authorized Distributor:*

**Controllers & I/O**

- Machine Automation Controllers (MAC) • Motion Controllers
- Programmable Logic Controllers (PLC) • Temperature Controllers • Remote I/O

**Robotics**

- Industrial Robots • Mobile Robots

**Operator Interfaces**

- Human Machine Interface (HMI)

**Motion & Drives**

- Machine Automation Controllers (MAC) • Motion Controllers • Servo Systems
- Frequency Inverters

**Vision, Measurement & Identification**

- Vision Sensors & Systems • Measurement Sensors • Auto Identification Systems

**Sensing**

- Photoelectric Sensors • Fiber-Optic Sensors • Proximity Sensors
- Rotary Encoders • Ultrasonic Sensors

**Safety**

- Safety Light Curtains • Safety Laser Scanners • Programmable Safety Systems
- Safety Mats and Edges • Safety Door Switches • Emergency Stop Devices
- Safety Switches & Operator Controls • Safety Monitoring/Force-guided Relays

**Control Components**

- Power Supplies • Timers • Counters • Programmable Relays
- Digital Panel Meters • Monitoring Products

**Switches & Relays**

- Limit Switches • Pushbutton Switches • Electromechanical Relays
- Solid State Relays

**Software**

- Programming & Configuration • Runtime

## X-ON Electronics

Largest Supplier of Electrical and Electronic Components

*Click to view similar products for [Industrial Relays](#) category:*

*Click to view products by [Omron](#) manufacturer:*

Other Similar products are found below :

[6-1617801-8](#) [6-1618107-9](#) [7-1618273-3](#) [EV250-4A-02](#) [EV250-6A-01](#) [FCA-125-CX8](#) [FCA-325-159](#) [FCA-410-138](#) [8000-S3121](#) [8-1618273-6](#)  
[8-1618393-1](#) [GCA63A220VAC60HZ](#) [GCA63A277VAC60HZ](#) [GCA63A600VAC60HZ](#) [1-1672275-3](#) [1-1833005-4](#) [H-16/S1](#) [A711Z](#) [H-8C](#)  
[H-8/S11](#) [H-8/S68](#) [ACC530U20](#) [ACC730U30](#) [RF303ZM4-12](#) [DH18DA](#) [1423675-8](#) [AR4-15F13-C01](#) [AR7-41F11](#) [AVR907](#) [15732A200](#)  
[B07B032AC1-0329](#) [B329](#) [B490A](#) [1618279-1](#) [BHR124Y](#) [1810DDB-SX](#) [N417](#) [P30C42A12D1-120](#) [2-1617748-6](#) [2-1618375-1](#) [2-1618396-6](#)  
[2-1618398-1](#) [JMAPD-5XL](#) [JMGACD-5M](#) [JMGSC-5LW](#) [JMGSCD-5L](#) [PBO-18A1218](#) [PBO-40A3040](#) [K8DSPH1200480VAC](#) [KA-3C-12A](#)