

# Thermal Overload Relay J7TKN

## Thermal Overload Relay

- Direct and separate mounting
- Single phasing sensivity according to IEC 60947-4-1
- Finger proof (BGV A2)

## Accessories

- Set for single mounting

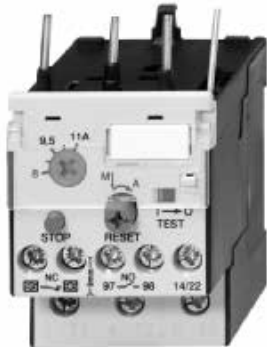

## Approved Standards

Standard	Guide No (US,C)
UL	NKCR, NKCR7
IEC 60947-4-1	
VDE 0660	
EN 60947-4-1	

## Ordering Information

### Model Number Legend

#### 1. Thermal Overload Relay

J7TKN-□-□□□  
1 2 3

- 1) Thermal Overload Relay
- 2)
  - A: for mini motor contactor, manual reset
  - AA: for mini motor contactor (auto reset)
  - AB: for motor contactor (4-11 kW; manual reset)
  - B: for motor contactor (4-15 kW; manual and auto reset)
  - C: for motor contactor (18.5 kW)
  - D: for motor contactor (22-37 kW)
  - E: for motor contactor (45-55 kW)
  - F: for motor contactor (75-90 kW)
  - G: for motor contactor (110-160 kW)
  - H: for motor contactor (250-500 kW)
- 3) Setting range
 

E18: 0.12-0.18 A	24: 17-24 A
E27: 0.18-0.27 A	32: 23-32 A
E4: 0.27-0.4 A	42: 28-42 A
E6: 0.4-0.6 A	52: 40-52 A
E9: 0.6-0.9 A	65: 52-65 A
1E2: 0.8-1.2 A	74: 60-74 A
1E8: 1.2-1.8 A	90: 60-90 A
2E7: 1.8-2.7 A	120: 80-120 A
4: 2.7-4 A	180: 120-180 A
6: 4-6 A	216: 144-216 A
9: 6-9 A	320: 216-320 A
11: 8-11 A	360: 240-360 A
14: 10-14 A	540: 360-540 A
18: 13-18 A	800: 540-800 A



#### 2. Accessories for Thermal Overload Relay



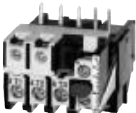
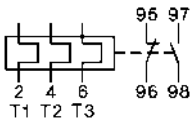
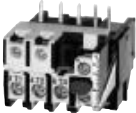
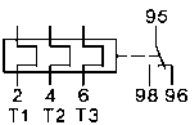

J74TK-□□  
1 2

- 1) Accessories for Thermal Overload Relay
- 2)
  - SM: Single mounting for J7TKN-B Types (4-32 kW)
  - M-AB: Single Mounting for J7TKN-AB Types (4-11 kw)
  - SU-550: Busbar set for J7TKN-H (250-300 kW)
  - SU-860: Busbar set for J7TKN-H (400-500 kW)

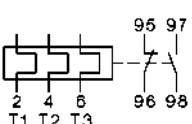

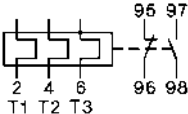

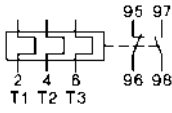

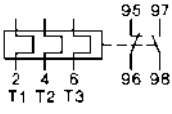
## ■ System overview

### Thermal Overload Relays for plug-in mounting

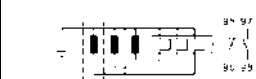
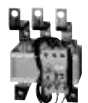

	Setting Range		Star Delta (A)	Type	Pack pcs.	Weight kg/pc.	
	D.O.L. (A)						
<b>For contactors J7KNA-09..., J7KNA-12... Manual reset</b>							
	0.12 - 0.18	-		 manual reset	J7TKN-A-E18	1	0.10
	0.18 - 0.27	-			J7TKN-A-E27	1	0.10
	0.27 - 0.4	-			J7TKN-A-E4	1	0.10
	0.4 - 0.6	-			J7TKN-A-E6	1	0.10
	0.6 - 0.9	-			J7TKN-A-E9	1	0.10
	0.8 - 1.2	-			J7TKN-A-1E2	1	0.10
	1.2 - 1.8	-			J7TKN-A-1E8	1	0.10
	1.8 - 2.7	-			J7TKN-A-2E7	1	0.10
	2.7 - 4	-			J7TKN-A-4	1	0.10
	4 - 6	7 - 10.5			J7TKN-A-6	1	0.10
	6 - 9	10.5 - 15.5			J7TKN-A-9	1	0.10
	8 - 11	14 - 19			J7TKN-A-11	1	0.10
10 - 14	18 - 24		J7TKN-A-14	1	0.10		
<b>For contactors J7KNA-09..., J7KNA-12... Auto reset</b>							
	0.12 - 0.18	-		 auto reset	J7TKN-AA-E18	1	0.10
	0.18 - 0.27	-			J7TKN-AA-E27	1	0.10
	0.27 - 0.4	-			J7TKN-AA-E4	1	0.10
	0.4 - 0.6	-			J7TKN-AA-E6	1	0.10
	0.6 - 0.9	-			J7TKN-AA-E9	1	0.10
	0.8 - 1.2	-			J7TKN-AA-1E2	1	0.10
	1.2 - 1.8	-			J7TKN-AA-1E8	1	0.10
	1.8 - 2.7	-			J7TKN-AA-2E7	1	0.10
	2.7 - 4	-			J7TKN-AA-4	1	0.10
	4 - 6	7 - 10.5			J7TKN-AA-6	1	0.10
	6 - 9	10.5 - 15.5			J7TKN-AA-9	1	0.10
	8 - 11	14 - 19			J7TKN-AA-11	1	0.10
10 - 14	18 - 24		J7TKN-AA-14	1	0.10		
<b>For contactors J7KN(G)-10(D) to J7KN(G)-22(D) or single mounting Auto reset</b>							
	0.12 - 0.18	-		 auto reset	J7TKN-AB-E18	1	0.10
	0.18 - 0.27	-			J7TKN-AB-E27	1	0.10
	0.27 - 0.4	-			J7TKN-AB-E4	1	0.10
	0.4 - 0.6	-			J7TKN-AB-E6	1	0.10
	0.6 - 0.9	-			J7TKN-AB-E9	1	0.10
	0.8 - 1.2	-			J7TKN-AB-1E2	1	0.10
	1.2 - 1.8	-			J7TKN-AB-1E8	1	0.10
	1.8 - 2.7	-			J7TKN-AB-2E7	1	0.10
	2.7 - 4	-			J7TKN-AB-4	1	0.10
	4 - 6	7 - 10.5			J7TKN-AB-6	1	0.10
	6 - 9	10.5 - 15.5			J7TKN-AB-9	1	0.10
	8 - 11	14 - 19			J7TKN-AB-11	1	0.10
	10 - 14	18 - 24			J7TKN-AB-14	1	0.10
13 - 18	23 - 31		J7TKN-AB-18	1	0.10		
17 - 23	30 - 40		J7TKN-AB-23	1	0.10		
22 - 30	38 - 52		J7TKN-AB-30	1	0.13		

	Setting Range			Type	Pack pcs.	Weight kg/pc.
	D.O.L. (A)	Star Delta (A)				
<b>For contactors J7KN-10D... to J7KN-22...</b>						
	0.12 - <b>0.18</b>	-	 manual and auto reset	J7TKN-B-E18	1	0.14
	0.18 - <b>0.27</b>	-		J7TKN-B-E27	1	0.14
	0.27 - <b>0.4</b>	-		J7TKN-B-E4	1	0.14
	0.4 - <b>0.6</b>	-		J7TKN-B-E6	1	0.14
	0.6 - <b>0.9</b>	-		J7TKN-B-E9	1	0.14
	0.8 - <b>1.2</b>	-		J7TKN-B-1E2	1	0.14
	1.2 - <b>1.8</b>	-		J7TKN-B-1E8	1	0.14
	1.8 - <b>2.7</b>	-		J7TKN-B-2E7	1	0.14
	2.7 - <b>4</b>	-		J7TKN-B-4	1	0.14
	4 - <b>6</b>	7 - 10.5		J7TKN-B-6	1	0.14
	6 - <b>9</b>	10.5 - 15.5		J7TKN-B-9	1	0.14
	8 - <b>11</b>	14 - 19		J7TKN-B-11	1	0.14
	10 - <b>14</b>	18 - 24		J7TKN-B-14	1	0.14
	13 - <b>18</b>	23 - 31		J7TKN-B-18	1	0.14
17 - <b>24</b>	30 - 41	J7TKN-B-24	1	0.14		
23 - <b>32</b>	40 - 55	J7TKN-B-32	1	0.14		
<b>For contactors J7KN-24... to J7KN-40...</b>						
	22 - <b>42</b>	48 - 73	 manual and auto reset	J7TKN-C-42	1	0.30
<b>For contactors J7KN-50...-J7KN-74...</b>						
	40 - <b>52</b>	70 - 90	 manual and auto reset	J7TKN-D-52	1	0.40
	52 - <b>65</b>	90 - 112		J7TKN-D-65	1	0.40
	60 - <b>74</b>	104 - 128		J7TKN-D-74	1	0.40

Thermal Overload relays for separate mounting

Setting Range		Type		Pack	Weight	
D.O.L. (A)	Star Delta (A)			pcs.	kg/pc.	
<b>For contactors J7KN-90... to J7KN-115...</b>						
	60 - 90	104 - 156	 manual reset	<b>J7TKN-E-90</b>	1	0.90
	80 - 120	140 - 207		<b>J7TKN-E-120</b>	1	0.90
<b>For contactors J7KN-151... to J7KN-176... (incl. busbar set)</b>						
	120 - 180	208 - 312	 manual and auto reset	<b>J7TKN-F-180</b>	1	1.5
<b>For contactors J7KN-210... to J7KN-316... (incl. busbar set)</b>						
	144 - 216	250 - 374	 manual and auto reset	<b>J7TKN-G-216</b>	1	1.8
	216 - 320	374 - 554		<b>J7TKN-G-320</b>	1	1.8
<b>For contactors J7KN-450... to J7KN-860... (excl. busbar set)</b>						
	240 - 360	416 - 623	 manual and auto reset	<b>J7TKN-H-360</b>	1	4.2
	360 - 540	623 - 935		<b>J7TKN-H-540</b>	1	4.2
	540 - 800	935 - 1385		<b>J7TKN-H-800</b>	1	4.2

Accessories

	for overload relay	Cable Cross-section to clamp (mm <sup>2</sup> )			Type	Pack	Weight
		solid or stranded	flexible	flex. with multicore cable end			
<b>Sets for single mounting</b>							
	J7TKN-AB	0.75 - 6	0.75 - 4	0.5 - 4	<b>J74TK-M-AB</b>	1	0.035
	J7TKN-B	0.75 - 6	0.75 - 4	0.5 - 4	<b>J74TK-SM</b>	1	0.035
					Type	Pack	Weight
for overload relay		for contactors				Set	Set
<b>Busbar sets</b>							
	J7TKN-H-360/540	J7KN-450, J7KN-550			<b>J74TK-SU-550</b>	1	1.7
	J7TKN-H-540/800	J7KN-700, J7KN-860			<b>J74TK-SU-860</b>	1	2.1

# Specifications

## Engineering data and Characteristics

**Thermal Overload Relays**, tripping times for selection to motors of protection degree EEx e  
**Relays With Standard Tripping Characteristic**

Setting Range		Tripping time(in seconds) depending on the multiple of the current setting from cold condition (tolerance ±20% of the tripping time)					
A	A	$I_A/I_N$ 3	$I_A/I_N$ 4	$I_A/I_N$ 5	$I_A/I_N$ 6	$I_A/I_N$ 7,2	$I_A/I_N$ 8
<b>J7TKN-A*...</b>							
0,12	- 0,18	18,5	10,4	7,2	5,5	4,3	3,6
0,18	- 0,27	16,7	9,8	6,5	5	4,1	3,5
0,27	- 0,4	19,4	12,1	8,2	5,9	4,9	4,2
0,4	- 0,6	18,7	11,2	8	6	4,9	4,1
0,6	- 0,9	19,7	11,6	8,1	6,1	4,9	4,2
0,8	- 1,2	22,9	13,6	10	7,3	6	5,2
1,2	- 1,8	22,2	13,2	9,2	7,6	5,8	5,3
1,8	- 2,7	23	13,7	9,3	7,6	5,7	5,1
2,7	- 4	24	14,4	9,9	7,8	5,9	5,1
4	- 6	24,7	13,8	9,9	7,3	5,6	4,8
6	- 9	22	13,4	8	5,7	4,1	3,5
8	- 11	17,4	9,2	5,9	4,1	2,9	2,3
10	- 14	26,4	12,9	7,6	5,2	3,5	2,8
13	- 18	4,7	7,7	4,8	3,2	2,3	1,7
17	- 23	16,2	8,4	5,0	3,6	2,4	1,8
22	- 30	16,8	8,5	5,0	3,6	2,3	1,9
<b>J7TKN-B...</b>							
0,12	- 0,18	16,1	9,6	6,8	5,3	4,2	3,7
0,18	- 0,27	16,6	9,7	6,7	5,2	4,1	3,6
0,27	- 0,4	19,4	11,4	7,9	6,1	4,7	4,2
0,4	- 0,6	18,7	10,9	7,6	5,9	4,6	4,0
0,6	- 0,9	19,2	11,2	7,7	5,9	4,6	4,1
0,8	- 1,2	20,8	12,3	8,5	6,6	5,2	4,6
1,2	- 1,8	25,5	14,1	9,8	7,6	5,9	5,2
1,8	- 2,7	26,6	15,6	10,9	8,3	6,5	5,7
2,7	- 4	22,7	13,6	9,5	7,4	5,8	5,1
4	- 6	22,2	13,3	9,3	7,1	5,6	4,9
6	- 9	20,4	11,9	8,2	6,1	4,7	4,0
8	- 11	20,9	11,8	7,9	5,7	4,3	3,5
10	- 14	21,3	11,7	7,4	5,1	3,7	3,0
13	- 18	21,2	12,1	8,0	6,2	4,6	4,1
17	- 24	20,4	12	8,6	6,3	4,5	3,7
23	- 32	20,2	10,2	6,7	4,7	3,4	2,8
<b>J7TKN-C-42</b>							
28	- 42	25,2	13,3	8	5,5	4	3,1
<b>J7TKN-D...</b>							
40	- 52	18,3	9,2	5,6	3,9	2,8	2,2
52	- 65	17,8	8,7	5,2	3,4	2,5	1,9
60	- 74	19,5	13,5	11	10	9,5	8,5
<b>J7TKN-E...</b>							
60	- 90	19,5	13,5	11	10	9,5	8,5
80	- 120	18	11	10	9	8,5	8
<b>J7TKN-H...</b>							
260	- 360	23,3	14,1	10,0	7,6	6,1	5,4
340	- 480	23,0	13,8	9,6	7,6	6,1	5,4
440	- 620	20,5	12,4	9,0	7,0	5,5	5,0
560	- 800	21,0	12,5	9,0	7,0	6,6	5,2

When selecting a standard overload, refer to the tripping curve. Determine the values of the starting current ratio  $I_A/I_N$  and the time  $t_E$  which is marked on the label of the motor. The overload must trip within the  $t_E$  time, which means that the tripping curve from cold condition must be (20% due to tolerance) below the coordination point  $I_A/I_N$  and the time  $t_E$ .

$I_A$  = Starting current of motor

$I_N$  = Rated current of motor

$t_E$  =  $t_{E}$ -time of motor

All tripping times of overload relays J7TKN-A\* are shorter than the minimum values of the  $t_E$  time for motors of protection degree EEx e acc. to EN 50019 and therefore are suitable for all motors of protection degree EEx e. For these overload relays the selection on basis of tripping curves is thereby not necessary.

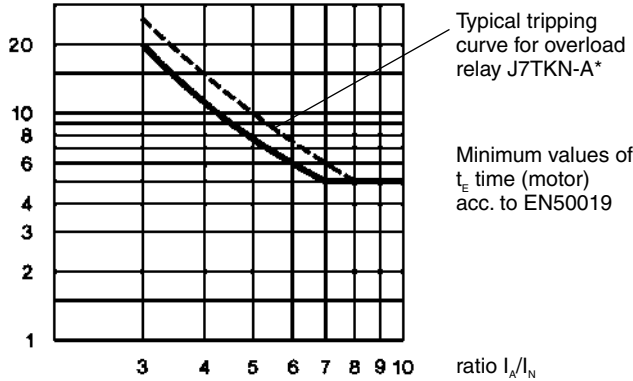

Labels of tripping curves for each setting range, sized 148x105mm (self-adhesive) are available on request.

Specify type and setting range.

Fuses for J7TKN-A; J7TKN-B; J7TKN-C; J7TKN-D; J7TKN-E; J7TKN-F/G/H

Type	Setting Range						Max. Fuse Size According to Coordination-type				Fuse UL	Fuse UL (SCCR) Short Circuit Current Rating kA
	DOL			Star Delta			"2" <sup>1</sup> quick	slow, gL(gG)	"1" <sup>1</sup> slow, gL(gG)	aM		
	A		A	A		A	A	A	A			
J7TKN-A*	0.12	-	<b>0.18</b>		-		0.5 <sup>2</sup>	0.5 <sup>2</sup>	25	-	15	5
J7TKN-B	0.18	-	<b>0.27</b>		-		1.0 <sup>2</sup>	1.0 <sup>2</sup>	25	-	15	5
	0.27	-	<b>0.4</b>		-		2	2	25	-	15	5
	0.4	-	<b>0.6</b>		-		2	2	25	-	15	5
	0.6	-	<b>0.9</b>		-		4	4	25	-	15	5
	0.8	-	<b>1.2</b>		-		4	4	25	2	15	5
	1.2	-	<b>1.8</b>		-		6	6	25	2	15	5
	1.8	-	<b>2.7</b>		-		10	10	25	4	15	5
	2.7	-	<b>4</b>		-		16	10	25	4	15	5
	4	-	<b>6</b>	7	-	10.5	20	16	25	6	15	5
	6	-	<b>9</b>	10.5	-	15.5	35	25	35	10	25	5
	8	-	<b>11</b>	14	-	19	35	25	35	16	30	5
	10	-	<b>14</b>	18	-	24	50	35	63	16	40	5
	13	-	<b>18</b>	23	-	31	50	35	63	20	50	5
	17	-	<b>24</b>	30	-	41	63	50	63	25	60	5
	23	-	<b>32</b>	40	-	55	80	63	80	35	70	5
J7TKN-C	28	-	<b>42</b>	48	-	73	100	80	150	50	110	5
J7TKN-D	40	-	<b>52</b>	70	-	90	160	100	150	63	200	5
	52	-	<b>65</b>	90	-	112	160	125	150	80	250	10
	60	-	<b>74</b>	104	-	128	160	125	150	80	250	10
J7TKN-E	60	-	<b>90</b>	104	-	156	For short circuit protecting overload relays with current transformer use fuse according to the contactor of the combination.				300	10
	80	-	<b>120</b>	140	-	207					-	-
J7TKN-F/G/H	all ranges										-	-

\*1) Coordination-type according to IEC 60947-4-1:

„2“: Light contact welding accepted. Thermal overload relay must not be damaged.

„1“: Welding of contactor and damage of the thermal overload relay allowed.

\*2) Miniature fuse

**Tripping Characteristics for J7TKN-A\*, J7TKN-B, J7TKN-C, J7TKN-D**

Detailed tripping times for each range see table page 5

**with three-phase load**

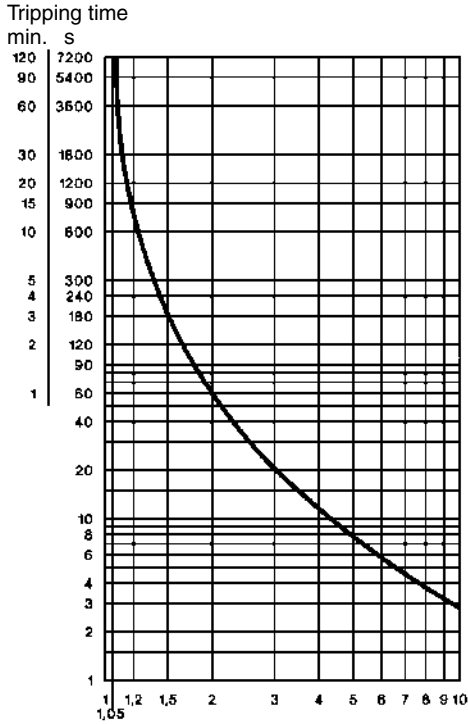

Average value of typical tolerance curves from cold condition

Proceeding from service conditions the times decrease to 20-30% of the characteristic values

F.L.C. multiplication factor

**with two-pole load**

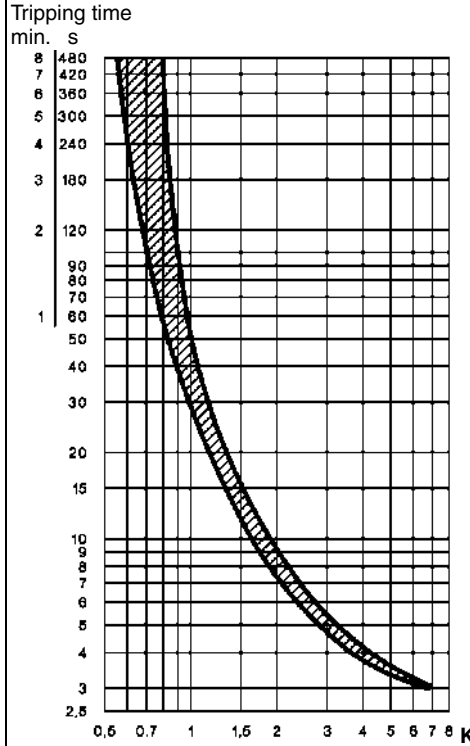

Typical tolerance curve from cold condition

Proceeding from service conditions the times decrease to 70-80% of the characteristic values

$K = I_{max}/I_e$

$I_{max}$  = max. phase current  
 $I_e$  = max. scale value

**Tripping Characteristics for J7TKN-E**

Detailed tripping times for each range see table page 5

**with three-phase load**

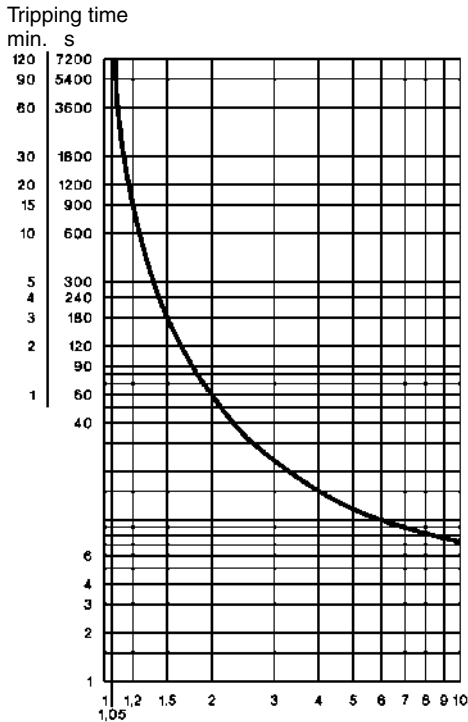

Average value of typical tolerance curves from cold condition

Proceeding from service conditions the times decrease to 20-30% of the characteristic values

F.L.C. multiplication factor

**with two-pole load**

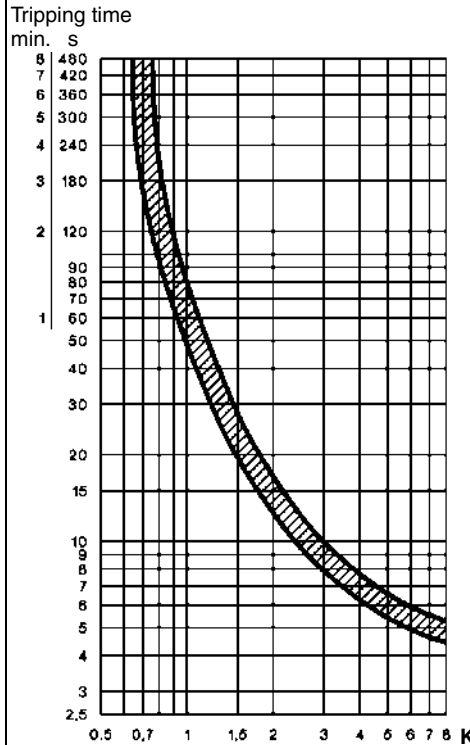

Typical tolerance curve from cold condition

Proceeding from service conditions the times decrease to 70-80% of the characteristic values

$K = I_{max}/I_e$

$I_{max}$  = max. phase current  
 $I_e$  = max. scale value

### Tripping Characteristics for J7TKN-F, J7TKN-G

Detailed tripping times for each range see table page 5

with three-phase load

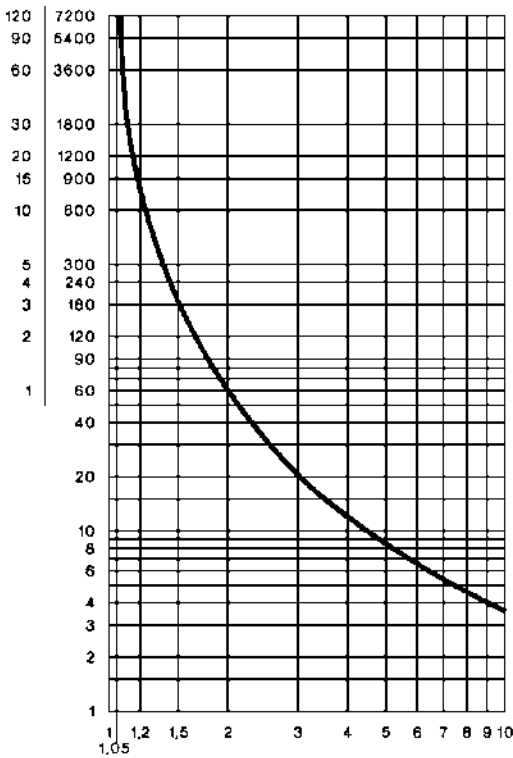

### Tripping Characteristics for J7TKN-H

Detailed tripping times for each range see table page 5

with three-phase load

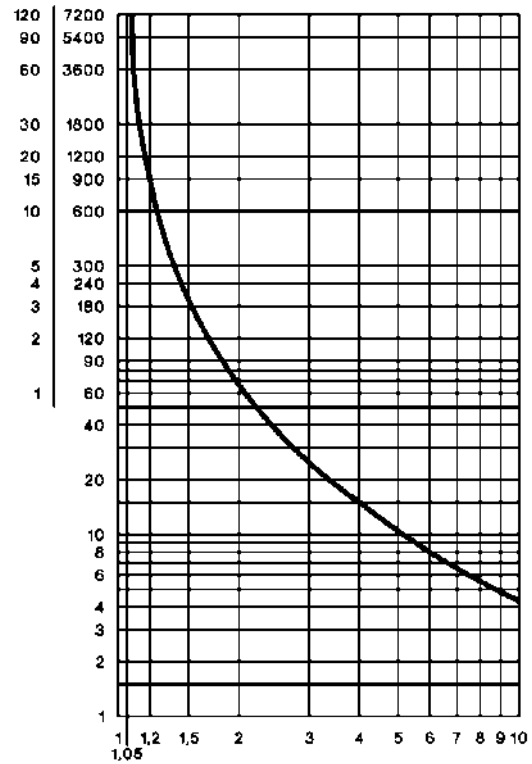

### Position of Terminals

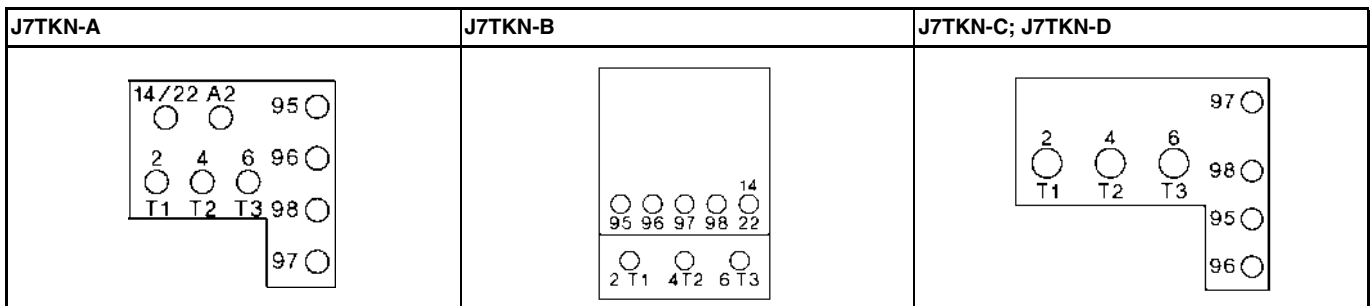



## Thermal Overload Relays

Data according to IEC 60947-4-1, IEC 60947-5-1, VDE 0660, EN 60947-4-1, EN 60947-5-1

			J7TKN-A(B)	J7TKN-AA	J7TKN-B	J7TKN-C	J7TKN-D	J7TKN-E	J7TKN-F	J7TKN-G	J7TKN-H
<b>Type</b>											
<b>Rated insulation voltage <math>U_i^{*1}</math></b>	V~		690	690	690	690	690	750	1000	1000	1000
<b>Permissible ambient temperature</b>											
operation	open	°C					-25 to 60				-25 to 55
storage		°C					-50 to 70				-40 to 70
<b>Trip class according to IEC 60947-4-1</b>			10A	10A	10A	10A	10A	20	10A	10A	10
<b>Cable cross-section</b>											
main connector	solid or stranded	mm <sup>2</sup>	0.75-6 + 0.75-2.5 <sup>*2</sup>	0.75-6 + 0.75-2.5 <sup>*3</sup>	0.75-6	0,75-10	4-35 <sup>*2</sup>	<sup>*4</sup>	Busbar	Busbar	<sup>*5</sup>
		mm <sup>2</sup>	0.75-4 + 0.5-2.5 <sup>*2</sup>	0.75-4 + 0.5-2.5 <sup>*2</sup>	1-4	0,75-6	6-25 <sup>*2</sup>		18x4	25x6	
	flexible with multicore cable end	mm <sup>2</sup>	0.5-2.5 + 0.5-1.5	0.5-2.5 + 0.5-1.5	0.75-4	0.75-6	4-25		Screw M8	Screw M10	
Cables per clamp	number		1+1	1+1	2	2	1		1	1	
auxiliary connector	solid	mm <sup>2</sup>					0.75-2.5 <sup>*2</sup>				1-2.5 <sup>*2</sup>
		mm <sup>2</sup>					0.5-2.5 <sup>*2</sup>				1-2.5 <sup>*2</sup>
		mm <sup>2</sup>					0.5-1.5				1-2.5 <sup>*2</sup>
Cables per clamp	number						2				2
<b>Auxiliary contacts</b>											
<b>Rated insulation voltage <math>U_i^{*1}</math></b>											
same potential	V~		690	690	690	690	690	690	690	690	500
different potential	V~		440	440	440	250	250	440	440	440	500
<b>Utilization category AC15</b>											
Rated operational current $I_e$	24V	A	5	5	3	4 <sup>*6</sup>	4 <sup>*6</sup>	5	3	3	4 <sup>*7</sup>
	230V	A	3	3	2	2.5	2.5	3	2	2	2.5
	400V	A	2	2	1	1.5	1.5	2	1	1	1.5
	690V	A	0.6	0.6	0.5	0.6	0.6	0.6	0.5	0.5	0.6
<b>Utilization category DC13</b>											
Rated operational current $I_e$	24V	A	1.2	1.2	1	1.2	1.2	1.2	1.2	1.2	1.2
	110V	A	0.15	0.15	0.15	0.15	0.15	0.15	0.15	0.15	0.15
	220V	A	0.1	0.1	0.1	0.1	0.1	0.1	0.1	0.1	0.1
<b>Short circuit protection (without welding 1kA)</b>											
highest fuse rating	gL (gG)	A	6	6	4	6	6	6	4	4	6
<b>Setting range</b>	A		to 23	to 23	all	28-42	52-65	all	-	-	-
<b>Power loss per current path (max.)</b>											
minimum setting value	W		1.1	1.1	1.1	1.3	2.9	1.1	-	-	-
maximum setting value	W		2.3	2.3	2.3	3.3	4.5	2.5	-	-	-

\*1) Suitable for: earthed-neutral systems, overvoltage category I to III, pollution degree 3 (standard-industry:  $U_{imp} = 4kV$  (at 440V), 6kV (at 690V). Data for other conditions on request.

\*2) Maximum cable cross-section with prepared conductor

\*3) Maximum cable cross-section with prepared conductor

\*4) Without terminals, suitable for bushing one connector 70mm<sup>2</sup> (stranded) per phase

\*5) Busbar sets see accessories page 4

\*6) Switching capacity of the start contact: AC15 300VA, max. 1.5A, DC13 (max. 220V) 30W, max. 1.5A

\*7) Switching capacity of the make contact: AC15 400VA, max. 1.7A, DC13 (max. 220V) 10W, max. 1A

Data according to cULus

Type		J7TKN-A	J7TKN-B	J7TKN-C	J7TKN-D	J7TKN-E
Rated insulation voltage	V~	600	600	600	600	600
Rated current	A	23	32	42	74	85
<b>Auxiliary contacts</b>						
Rated voltage						
same potential	V AC	600	600	600	600	600
different potential	V~	150	150	150	150	150
<b>Switching capacity AC</b>						
of aux. contacts	VA	500	500	600	600	600
	A	4	2	4	4	4

Temperature Compensation

In case of higher ambient temperature use the following formula:  
 (Ambient temperature - 20) × 0.125 = correction factor in % of the full load motor current

Example:  
 Ambient temperature 70°C, full load motor current 7A  
 (70 - 20) × 0.125 = 6.25%  
 Setting value: 7A + 6,25% = 7.44A

■ Dimensions

J7KNA-09 + J7TKN-A(A)  
 J7KNA-12

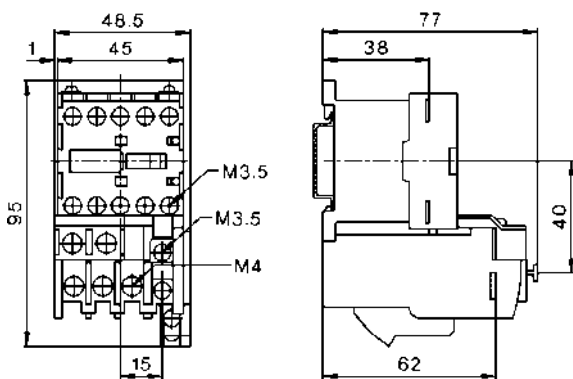

J7KN-10D + J7TKN-AB  
 J7KN-14D  
 J7KN-18D  
 J7KN-22D

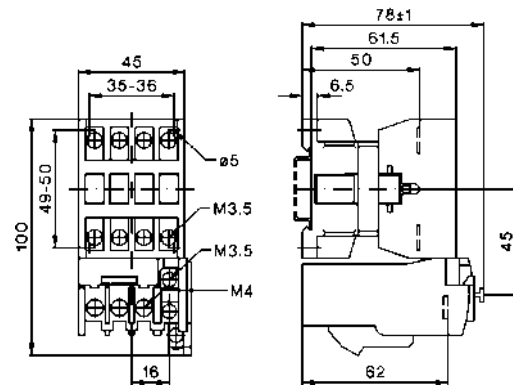

J7KNG-10 + J7TKN-AB  
 J7KNG-14  
 J7KNG-18  
 J7KNG-22

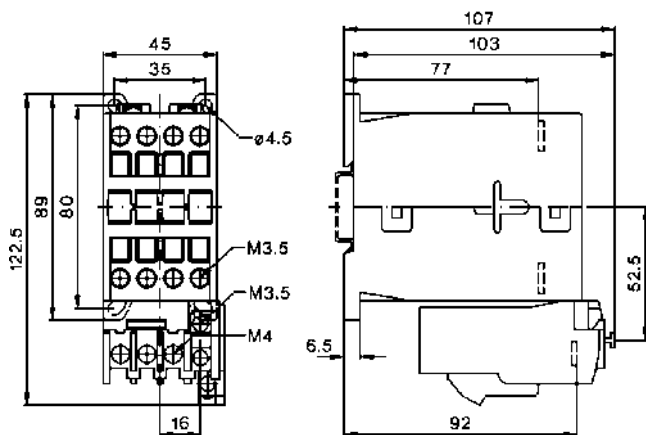

J7KN-10D + J7TKN-B  
 J7KN-14D  
 J7KN-18D  
 J7KN-22D

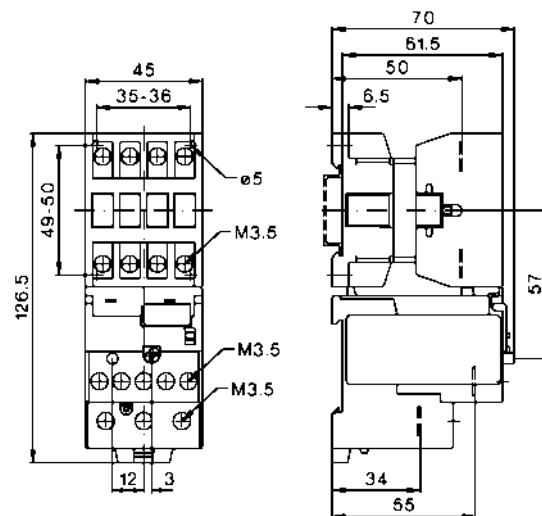

J7KNG-10 + J7TKN-B  
J7KNG-14  
J7KNG-18  
J7KNG-22

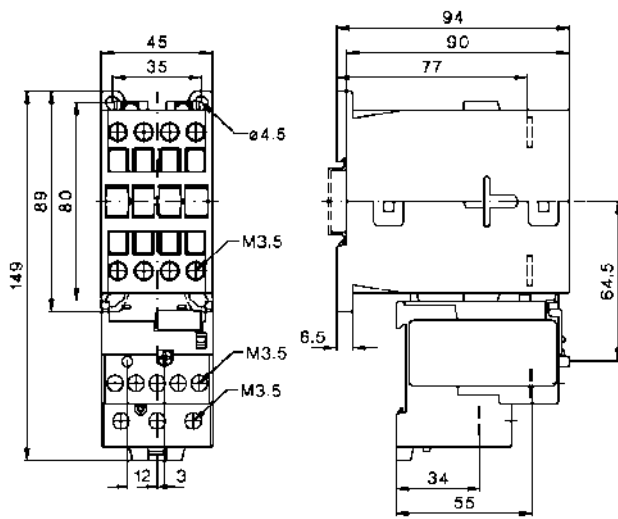

J7KN-24 + J7TKN-B  
J7KN-32  
J7KN-40

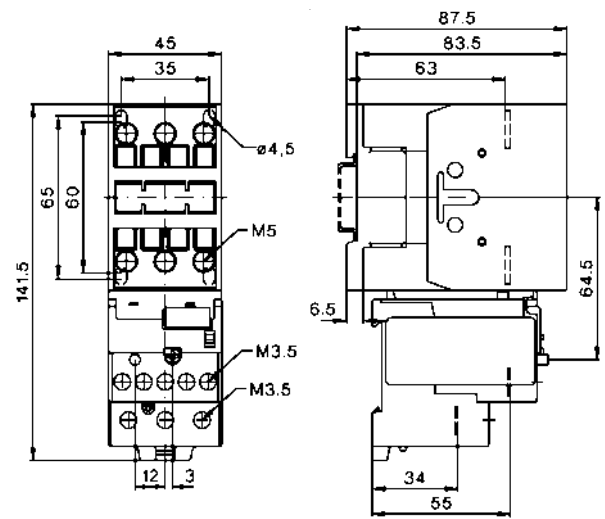

J7KNG-24 + J7TKN-B  
J7KNG-32

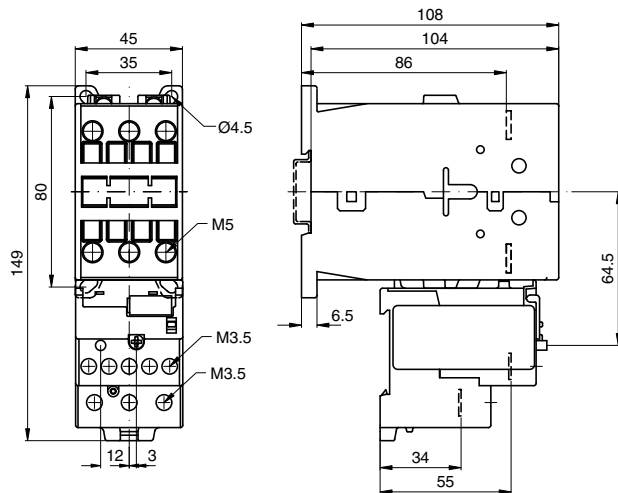

J7KN-24 + J7TKN-C  
J7KN-32  
J7KN-40

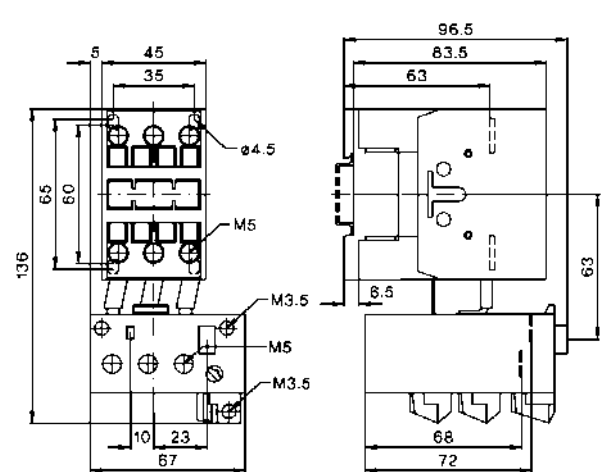

J7KNG-40 + J7TKN-C

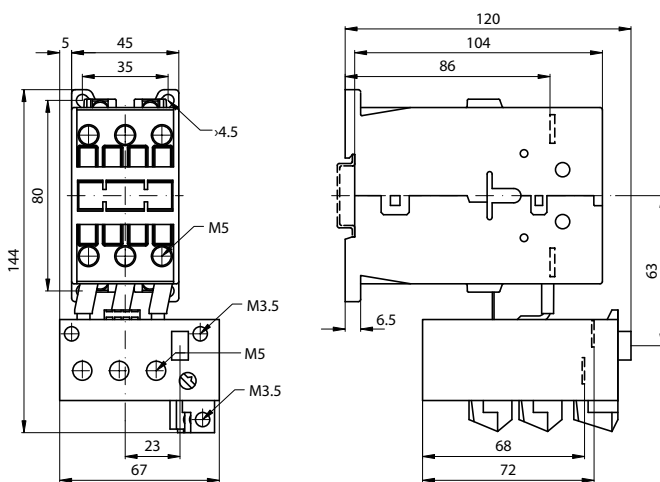

J7KN-50 + J7TKN-D  
J7KN-62  
J7KN-74

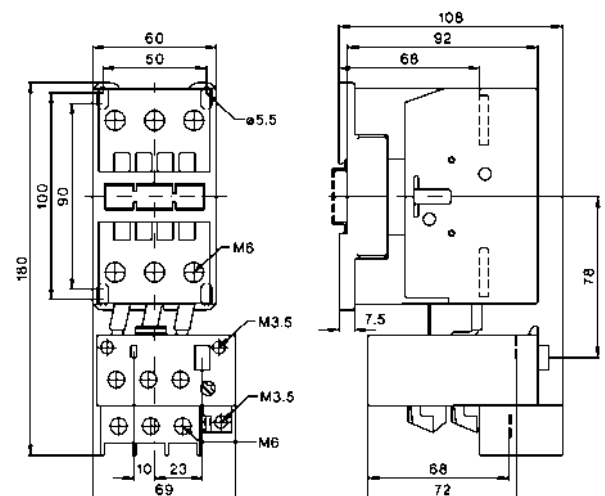



J74TK-M-AB

J7TKN-AB + J74TK-M-AB for snap-on 35 mm DIN-rail according to DIN EN50022 and screw mounting (single mounting)

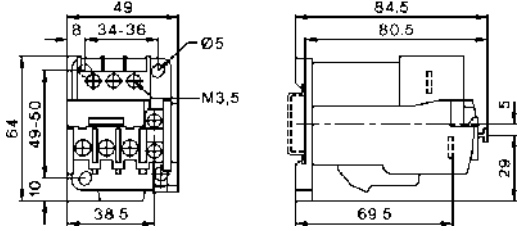

Do not use/install these products before having read the applicable precautions as listed in Cat. No. J09-EN-01 available from [www.europe.omron.com](http://www.europe.omron.com) or on request from OMRON local sales office.

ALL DIMENSIONS SHOWN ARE IN MILLIMETERS.

## X-ON Electronics

Largest Supplier of Electrical and Electronic Components

*Click to view similar products for [Contactors - Electromechanical category](#):*

*Click to view products by [Omron manufacturer](#):*

Other Similar products are found below :

[6-1618400-7](#) [686-117111](#) [686-120111](#) [686-924](#) [686-948](#) [70-901](#) [70-914](#) [MB-3D-6](#) [MC-22A/4-AC120V](#) [8-1616943-9](#) [8-1672124-5](#)  
[A40-30-10-84](#) [120-905](#) [A701U](#) [120-904](#) [1393132-9](#) [154-905](#) [154-912](#) [154-913](#) [154-915](#) [154-902](#) [154-910](#) [AVR743D](#) [B6-40-00-84](#) [B7-40-00-84](#) [1616017-5](#) [1616021-1](#) [MVDILM](#) [HP-11D-24](#) [P25-E5019-1](#) [P30C47A12D1-120](#) [P40C47A12D1-120](#) [P40P47D13P1-24-01](#) [CA7-12-10-240](#) [CA7-72-00-24Z](#) [90-162](#) [9-1393132-2](#) [2NC4F0222](#) [A275KXXV2-120VAC](#) [ACC338UMM20](#) [AF80-30-11-13](#) [SZ-B1](#) [CGC-9A-120](#) [3GC2H0M22](#) [3NC0T0A22](#) [3NC1Q0A22](#) [3NC2H0A22](#) [3NC2T0122/SE](#) [3TF3400-0BB4](#) [MC-12B-DC24V](#)