

## Compact AC Digital Display

## K3TF

### Easy-to-use, Low-cost Display that Accepts AC Input

- Compact DIN-size (96W x 48H) body
- Requires mounting thickness of only 3.5 mm
- Highly visible 14.2-mm LED display
- Detects and displays root-mean-square value of half-wave rectified current
- Optional water-resistant, IP51 construction



## Ordering Information

### Models with Line Monitor

Range	Measuring ranges	Supply voltage		
		100 to 120 VAC	200 to 240 VAC	24 VAC
AC voltage	0 to 199.9 V	<b>K3TF-V814</b>	<b>K3TF-V815</b>	<b>K3TF-V818</b>
	0 to 400 V	<b>K3TF-V914</b>	<b>K3TF-V915</b>	<b>K3TF-V918</b>

### Models with Signal Monitor

Range	Measuring ranges	Supply voltage		
		100 to 120 VAC	200 to 240 VAC	24 VAC
AC voltage	0 to 199.9 mV	<b>K3TF-V514</b>	<b>K3TF-V515</b>	<b>K3TF-V518</b>
	0 to 1.999 V	<b>K3TF-V614</b>	<b>K3TF-V615</b>	<b>K3TF-V618</b>
	0 to 19.99 V	<b>K3TF-V714</b>	<b>K3TF-V715</b>	<b>K3TF-V718</b>
AC current	0 to 1.999 mA	<b>K3TF-A614</b>	<b>K3TF-A615</b>	<b>K3TF-A618</b>
	0 to 19.99 mA	<b>K3TF-A714</b>	<b>K3TF-A715</b>	<b>K3TF-A718</b>
	0 to 199.9 mA	<b>K3TF-A814</b>	<b>K3TF-A815</b>	<b>K3TF-A818</b>
	0 to 1.999 A	<b>K3TF-A914</b>	<b>K3TF-A915</b>	<b>K3TF-A918</b>

### Model Number Legend

K3TF -      
           1   2   3   4

#### 1, 2. Input Code

V5: 0 to 199.9 mV  
 V6: 0 to 1.999 V  
 V7: 0 to 19.99 V  
 V8: 0 to 199.9 V  
 V9: 0 to 400 V  
 A6: 0 to 1.999 mA  
 A7: 0 to 19.99 mA  
 A8: 0 to 199.9 mA  
 A9: 0 to 1.999 A



#### 3. Series No.

1: Current series

#### 4. Supply Voltage

4: 100 to 120 VAC  
 5: 200 to 240 VAC  
 8: 24 VAC (available by request)

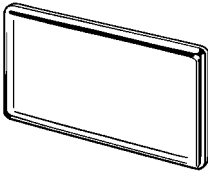
## ■ ACCESSORIES (ORDER SEPARATELY)

Description	Appearance	Part number
Water-resistant soft front cover		K32-L49SC
Terminal cover		K32-L49TC

## Specifications

### ■ RATINGS

Supply voltage	24 VAC (50/60 Hz); 100 to 120 VAC (50/60 Hz); 200 to 240 VAC (50/60 Hz)	
Operating voltage range	-15% to +10% of supply voltage	
Power consumption	4 VA (at max. load)	
Insulation resistance	10 M $\Omega$ min. (at 500 VDC) between external terminal and case	
Dielectric strength	2,000 VAC minimum for 1 min between input terminal and power supply 2,000 VAC minimum for 1 min between external terminal and case	
Noise immunity	$\pm$ 1,500 V on power supply terminals in normal or common mode	
Vibration resistance	Malfunction Destruction	10 to 55 Hz, 0.5-mm single amplitude for 10 min each in X, Y, and Z directions 10 to 55 Hz, 0.75-mm single amplitude for 2 hrs each in X, Y, and Z directions
Shock resistance	Malfunction Destruction	100 m/s <sup>2</sup> (approx. 10G) for 3 times each in 6 directions 300 m/s <sup>2</sup> (approx. 30G) for 3 times each in 6 directions
Ambient temperature	Operating Storage	-10° to 55°C; 14° to 131°F (with no icing) -20° to 65°C; -4° to 149°F (with no icing)
Ambient humidity	Operating	35% to 85% (with no condensation)
Ambient atmosphere	Must be free of corrosive gas	
Enclosure ratings	Front panel Case Terminals	IEC IP51 (See Note) IEC IP20 IEC IP00
Approvals	UL	File No. E41515
	CSA	File No. LR67027

**Note:** IP51 is maintained when the water-resistant soft cover and bracket are used. IP50 will, however, be maintained without these water-resistant accessories.

### ■ CHARACTERISTICS

Input signal	AC voltage/current
A/D conversion method	Double integral method
Root-mean-square value indication	Root-mean-square value of half-wave rectified current detected
Sampling period	2.5 times/s
Display refresh period	2.5 times/s
Max. displayed digits	3 1/2 digits (1999)
Display	7-segment LED
Decimal point display position	Selected with slide switch (See Note)
Overflow display	Overflow: 1□□□
External control	Process value hold (terminals on rear panel short-circuited)

**Note:** Only for models with signal monitor.

MEASURING RANGES

Monitor	Input range	Measuring range	Max. resolution	Input impedance	Accuracy	Max. permissible load
Line monitor	AC voltage	0 to 199.9 V	100 mV	10 MΩ	±0.3%rdg ±1 digit (see note 1)	500 V
		0 to 400 V	1 V	10 MΩ	±0.3%rdg ±1 digit	500 V
Signal monitor	AC voltage	0 to 199.9 mV	100 μV	10 MΩ	±0.3%rdg ±1 digit	250 V
		0 to 1.999 V	1 mV	10 MΩ	±0.3%rdg ±1 digit	250 V
		0 to 19.99 V	10 mV	1 MΩ	±0.3%rdg ±1 digit	250 V
	AC current	0 to 1.999 mA	1 μA	100 Ω	±0.5%rdg ±1 digit	50 mA
		0 to 19.99 mA	10 μA	10 Ω	±0.5%rdg ±1 digit	150 mA
		0 to 199.9 mA	100 μA	1 Ω	±0.5%rdg ±1 digit	500 mA
		0 to 1.999 A	1 mA	0.1 Ω	±0.5%rdg ±1 digit	3 A

**Note:** 1. With 100% input. ±0.3% FS ±1 digit when the input is less than 35% FS.  
 2. The above accuracy is at an input frequency range of 40 Hz to 1 kHz and an ambient temperature of 25° ±5°C.

Nomenclature

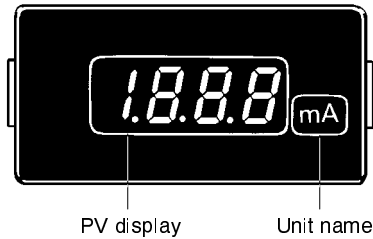

Select the decimal position with the slide switch under the cover on the front panel.

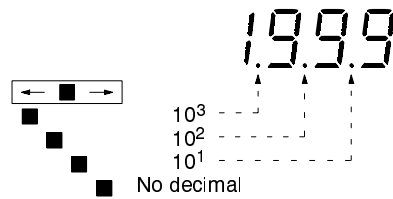

Dimensions

Unit: mm (inch)

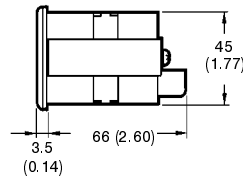
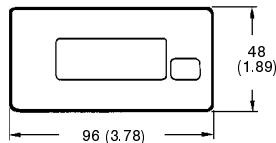
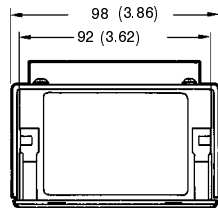
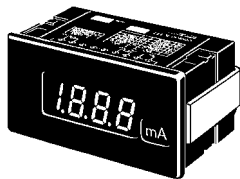

Panel Cutouts

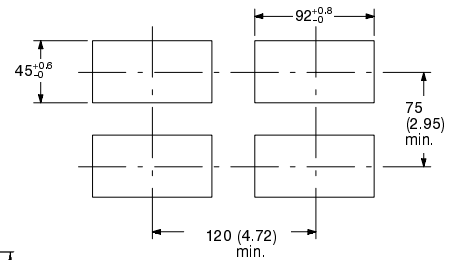

LED Indicator Size

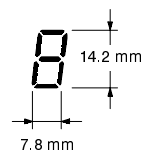

## ■ CIRCUIT DIAGRAMS

### High AC Voltage Measurement

When voltage exceeding the maximum voltage in the standard range is measured (for example: more than 400 V), a divider or potential transformer (PT) is connected externally.

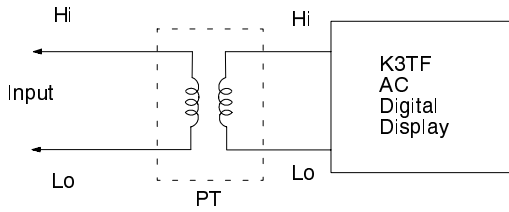

### Large AC Current Measurement

When AC current exceeding 2 A is measured, a current transformer (CT) is connected externally.

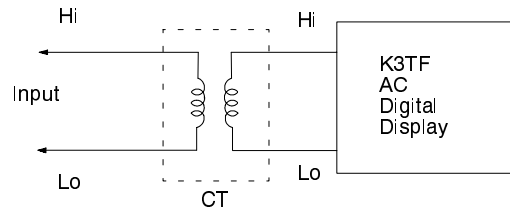

## Installation

### ■ EXTERNAL CONNECTIONS

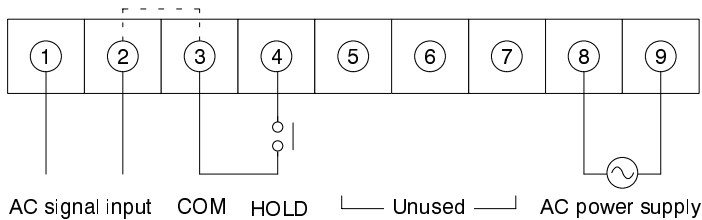

**Note:** Terminals 2 and 3 of the models are not internally insulated. Connect a relay with high contact reliability and insulation (with a minimum load current of 0.3 mA) or a photocoupler with high insulation (with a residual voltage of 1 V max. and a current leakage of 0.1 mA max.) to these terminals for external control.

## Precautions

### Installation

#### Location

- Never use the K3TF AC Digital Display in areas where corrosive gas (particularly sulfureted or ammonia gas) is generated.
- Do not use the K3TF in a location subject to severe shock or vibration, excessive dust, or excessive moisture.
- Select a location where the K3TF can be used at an ambient operating temperature  $-10^{\circ}$  to  $55^{\circ}\text{C}$  ( $14^{\circ}$  to  $131^{\circ}\text{F}$ ).
- Verify that panel thickness is 1 to 3.2 mm (0.04 to 0.13 in).
- Verify that the panel area and cut-out opening will allow the K3TF to be installed as perfectly horizontal as possible.

#### Installation Procedure

1. Insert the K3TF into the panel cut-out.
2. Secure the K3TF with the mounting bracket, fastening the mounting screws with a tightening torque of 5 kgf/cm (0.49 N/m). Always attach the mounting bracket before wiring.
3. Then, wire the terminals.

#### Removal Procedure

1. Loosen the screws and widen the bracket.
2. Always remove the wiring before removing the mounting bracket.

### Attach the Unit Label

Select a unit label from the sheet provided, and attach it to the K3TF AC Digital Display. (No product is shipped with the unit label attached.)

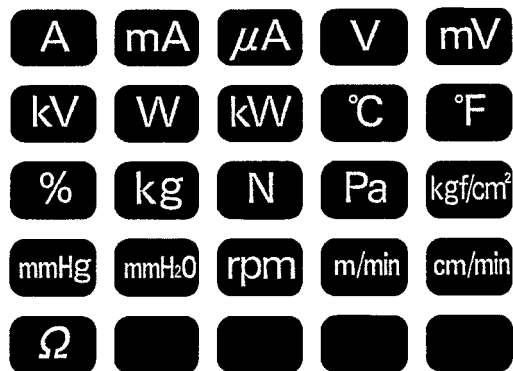

### Calibration

- To maintain processing accuracy, calibrate the K3TF AC Digital Display regularly .
- Use a standard signal generator with an accuracy of 99.99% min. for calibration.
- For precise calibration methods, refer to the Instruction Sheet provided with the K3TF Digital Display.
- After the front panel cover is removed to calibrate the K3TF or set the decimal position, do not touch components other than the slide switch and calibration adjustor.

**Note:** Never place metal objects on the K3TF after the cover is removed.

### Accessories (Order Separately)

#### Water-resistant Soft Front Cover

To maintain IP51 water-resistant standards, attach the water-resistant soft front cover and mounting bracket correctly before installing the K3TF. To calibrate the K3TF Digital Display, remove the water-resistant soft front cover.

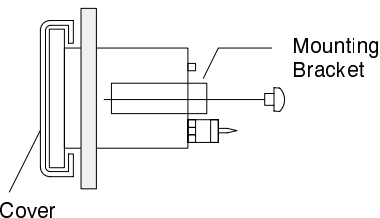

**Note:** Be sure to use the Water-resistant Soft Front Cover and mounting bracket together.

**OMRON**<sup>®</sup>  
OMRON ELECTRONICS, INC.  
One East Commerce Drive  
Schaumburg, IL 60173  
**1-800-55-OMRON**

**OMRON CANADA, INC.**  
885 Milner Avenue  
Scarborough, Ontario M1B 5V8  
**416-286-6465**

## X-ON Electronics

Largest Supplier of Electrical and Electronic Components

*Click to view similar products for [Controllers](#) category:*

*Click to view products by [Omron](#) manufacturer:*

Other Similar products are found below :

[61FGPN8DAC120](#) [CV500SLK21](#) [70177-1011](#) [F03-03 HAS C](#) [F03-31](#) [81550401](#) [FT1A-C12RA-W](#) [88981106](#) [H2CAC24A](#) [H2CRSAC110B](#)  
[R88A-CRGB003CR-E](#) [R88ARR080100S](#) [R88A-TK01K](#) [DCN1-1](#) [DRT2ID08C](#) [DTB4896VRE](#) [DTB9696CVE](#) [DTB9696LVE](#) [E53-AZ01](#)  
[E53E01](#) [E53E8C](#) [E5C4Q40J999FAC120](#) [E5CWLQ1TCAC100240](#) [E5GNQ03PFLKACDC24](#) [B300LKL21](#) [NSCXDC1V3](#) [NSH5-232CW-3M](#)  
[NT20SST122BV1](#) [NV-CN001](#) [OAS-160-N](#) [C40PEDRA](#) [K31S6](#) [K33-L1B](#) [K3MA-F 100-240VAC](#) [K3TX-AD31A](#) [89750101](#) [L595020](#)  
[SRM1-C02](#) [SRS2-1](#) [FT1A-C14SA-S](#) [G32X-V2K](#) [26546803](#) [26546805](#) [PWRA440A](#) [CPM1AETL03CH](#) [CV500SLK11](#) [3G2A5BI081](#)  
[3G2A5IA122](#) [3G2A5LK010E](#) [3G2A5OA223](#)