

Power-switching Compact General-purpose Relays



- The standard models include models that are compliant with the UL, CSA, and SEV safety standards and with the Electrical Appliances and Material Safety Act.
- Equipped with an arc barrier for arc interruption.
- Withstand voltages up to 2,000 V.
- New built-in diode and built-in CR circuit models have joined the series.
- The lineup also includes models that are compliant with the LR and VDE safety standards.
- Single-pole and double-pole models have AC4 ratings and DC2 ratings (operating coil ratings: 100/110 VAC, 110/120 VAC, 200/220 VAC, 220/240 VAC, and 100/110 VDC).
- Three-pole and four-pole models have AC4 ratings and DC2 ratings (operating coil ratings: 100/110 VAC, 200/220 VAC and 100/110 VDC).



Refer to the standards certifications and compliance section of your OMRON website for the latest information on certified models.

Refer to the *Common Relay Precautions*.

Model Number Structure

| Classification | Structure | Relays with Plug-in Terminals | | Relays with PCB Terminals | Case-surface mounting |
|--|-----------|-------------------------------|---------------------------|---------------------------|-----------------------|
| | | | With operation indicators | | |
| Standard models Compliance with Electrical Appliances and Material Safety Act | 1 | *LY1 | **LY1N | *LY1-0 | *LY1F |
| | 2 | *LY2 | **LY2N | *LY2-0 | *LY2F |
| | | Bifurcated | **LY2Z | **LY2ZN | **LY2Z-0 |
| | 3 | *LY3 | **LY3N | *LY3-0 | *LY3F |
| Models with diode for coil surge absorption (DC coil specification only) | 1 | **LY1-D | **LY1N-D2 | --- | --- |
| | 2 | *LY2-D | *LY2N-D2 | --- | --- |
| | | Bifurcated | **LY2Z-D | **LY2ZN-D2 | --- |
| | 3 | *LY3-D | *LY3N-D2 | --- | --- |
| Models with CR circuits for coil surge absorption (AC coil specification only) | 1 | --- | --- | / | / |
| | 2 | *LY2-CR | *LY2N-CR | | |
| | | Bifurcated | **LY2Z-CR | | |

- Note:**
1. Cells with a diagonal line cannot be manufactured. Ask your OMRON representative for details on manufacturing products for cells containing "—" in the above table.
 2. If #187 tab terminals are required, use the LY1F-T2 or LY2F-T2 (single-pole or double-pole models only).
 3. Refer to page 16 for information on plug-in terminal and socket combinations.
 4. Items with an asterisk (*) in the table are certified for UL, CSA, and SEV. This is indicated with a certification mark on the products.
 5. Items with two asterisks (**) in the table are certified for UL and CSA. This is indicated with a certification mark on the products.
 6. All models in the table are certified for IEC (TÜV).
 7. The models with plug-in terminals (single-pole, double-pole, and 4-pole) were combined with the PTF-E for the EC Declaration of Conformity. These products display the CE Marking.

Ordering Information

When your order, specify the rated voltage.

Relays

Models with Plug-in Terminals

| Classification | | 1 pole | | 2 poles | | 3 poles | | 4 poles | |
|---|--|---------|--|---|---|---------|---------------------------------|---------|---------------------------------|
| | | Model | Rated voltage (V) | Model | Rated voltage (V) | Model | Rated voltage (V) | Model | Rated voltage (V) |
| Models with single contacts | Standard models | LY1 | 12, 24, 100/110, 110/120, or 200/220 VAC | LY2 | 12, 24, 100/110, 110/120, 200/220, or 220/240 VAC | LY3 | 12, 24, 100/110, or 200/220 VAC | LY4 | 12, 24, 100/110, or 200/220 VAC |
| | | | 12, 24, 48, or 100/110 VDC | | 12, 24, 48, or 100/110 VDC | | 12, 24, 48, or 100/110 VDC | | 12, 24, 48, or 100/110 VDC |
| | Models with built-in operation indicators | LY1N | 12, 24, 100/110, 110/120, or 200/220 VAC | LY2N | 12, 24, 100/110, 110/120, 200/220, or 220/240 VAC | LY3N | 12, 24, 100/110, or 200/220 VAC | LY4N | 12, 24, 100/110, or 200/220 VAC |
| | | | 12, 24, or 100/110 VDC | | 12, 24, 48, or 100/110 VDC | | 12, 24, 48, or 100/110 VDC | | 12, 24, 48, or 100/110 VDC |
| | Models with built-in diodes | LY1-D | 12, 24, 48, or 100/110 VDC | LY2-D | 12, 24, 48, or 100/110 VDC | LY3-D | 12, 24, 48, or 100/110 VDC | LY4-D | 12, 24, 48, or 100/110 VDC |
| | Models with built-in diodes and operation indicators | LY1N-D2 | 12, 24, or 48 VDC | LY2N-D2 | 12, 24, 48, or 100/110 VDC | LY3N-D2 | 12, 24, or 100/110 VDC | LY4N-D2 | 12, 24, 48, or 100/110 VDC |
| Models with built-in CR circuits | --- | --- | LY2-CR | 100/110, 110/120, 200/220, or 220/240 VAC | --- | --- | --- | --- | |
| Models with built-in CR circuits and operation indicators | --- | --- | LY2N-CR | 100/110, 110/120, 200/220, or 220/240 VAC | --- | --- | --- | --- | |
| Bifurcated contacts | Standard models | --- | --- | LY2Z | 100/110 or 200/220 VAC | --- | --- | --- | --- |
| | | --- | --- | | 12, 24, 48, or 100/110 VDC | --- | --- | --- | --- |
| | Models with built-in operation indicators | --- | --- | LY2ZN | 100/110, 110/120, 200/220, or 220/240 VAC | --- | --- | --- | --- |
| | | --- | --- | | 12 or 24 VDC | --- | --- | --- | --- |
| | Models with built-in diodes | --- | --- | LY2Z-D | 12, 24, or 48 VDC | --- | --- | --- | --- |
| | Models with built-in diodes and operation indicators | --- | --- | LY2ZN-D2 | 12, 24, or 100/110 VDC | --- | --- | --- | --- |
| Models with built-in CR circuits | --- | --- | LY2Z-CR | 100/110 VAC | --- | --- | --- | --- | |
| Models with built-in CR circuits and operation indicators | --- | --- | LY2ZN-CR | 100, 110, 110/120, or 200/220 VAC | --- | --- | --- | --- | |

Relays with PCB Terminals

| Classification | | 1 pole | | 2 poles | | 3 poles | | 4 poles | |
|-----------------------------|-------|--------------------------------------|-------------------|---|-------------------|-----------------------------|-------------------|-----------------------------|-------------------|
| | | Model | Rated voltage (V) | Model | Rated voltage (V) | Model | Rated voltage (V) | Model | Rated voltage (V) |
| Models with single contacts | LY1-0 | 24, 100/110, 110/120, or 200/220 VAC | LY2-0 | 12, 24, 100/110, 110/120, 200/220, or 220/240 VAC | LY3-0 | 24, 100/110, or 200/220 VAC | LY4-0 | 24, 100/110, or 200/220 VAC | |
| | | 12 or 24 VDC | | 12, 24, 48, or 100/110 VDC | | 12, 24, 48, or 100/110 VDC | | 12, 24, 48, or 100/110 VDC | |
| Bifurcated contacts | --- | --- | LY2Z-0 | 100/110 VAC 24, 48, or 100/110 VDC | --- | --- | --- | --- | |

Case-surface Mounting

| Classification | | 1 pole | | 2 poles | | 3 poles | | 4 poles | |
|-----------------------------|------|---|-------------------|---|-------------------|---------------------------------|-------------------|---------------------------------|-------------------|
| | | Model | Rated voltage (V) | Model | Rated voltage (V) | Model | Rated voltage (V) | Model | Rated voltage (V) |
| Models with single contacts | LY1F | 24, 100/110, 110/120, 200/220, or 220/240 VAC | LY2F | 12, 24, 100/110, 110/120, 200/220, or 220/240 VAC | LY3F | 12, 24, 100/110, or 200/220 VAC | LY4F | 12, 24, 100/110, or 200/220 VAC | |
| | | 6, 12, 24, or 100/110 VDC | | 12, 24, 48, or 100/110 VDC | | 12, 24, or 100/110 VDC | | 12, 24, or 100/110 VDC | |
| Bifurcated contacts | --- | --- | LY2ZF | 24, 100/110, or 200/220 VAC 12 or 24 VDC | --- | --- | --- | --- | |

Accessories (Order Separately)



Connection Sockets

| Connecting method | Mounting method | Number of poles | Model |
|----------------------------------|------------------------------|-----------------|-------------|
| Front-mounting Sockets (PTA□) | Track or screw mounting | 1 or 2 | PTF08A |
| | | | PTF08A-E *1 |
| | | 3 | PTF11A |
| | | | 4 |
| | | PTF14A-E *1 | |
| Back-mounting Sockets (PT□) | Solder terminals | 1 or 2 | PT08 *2 |
| | | 3 | PT11 *2 |
| | | 4 | PT14 *2 |
| | Wrapping terminals | 1 or 2 | PT08QN |
| | | 3 | PT11QN |
| | | 4 | PT14QN |
| | Relays with PCB Terminals | 1 or 2 | PT08-0 |
| | | 3 | PT11-0 |
| | | 4 | PT14-0 |

*1. The PTF□A-E Relays have finger protection. Round terminals cannot be used. Use forked terminals.

*2. When ordering PT08, PT11, or PT14 sockets, please note that the minimum order quantity is 10 and orders are accepted in multiples of the minimum order.

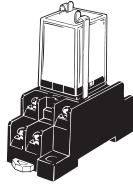
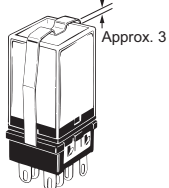
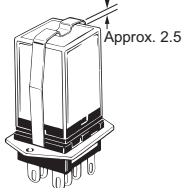
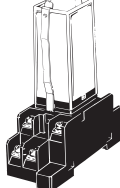
Relay Hold-down Clips

| Application Item | Used with Socket | | Used with Socket mounting plate | For models with built-in CR circuits | |
|---------------------------|---|---|---|---|---|
| Appearance |  |  |  |  |  |
| Model | PYC-A1 | PYC-P | PYC-S | Y92H-3 | PYC-1 |
| Minimum order (quantity)* | 100 | 100 | 10 | 10 | 10 |

* Orders are accepted in multiples of the minimum order.

Socket Mounting Plates

| Applicable sockets | Number of sockets | Model |
|--------------------|-------------------|-----------|
| PT08 PT08QN | 1 | PYP-1 *1 |
| | 18 | PYP-18 *2 |
| | 36 | PYP-36 *2 |
| PT11 PT11QN | 1 | PTP-1-3 |
| | 12 | PTP-12 |
| PT14 PT14QN | 1 | PTP-1 |
| | 10 | PTP-10 |

*1. When ordering PYP-1, please note that the minimum order quantity is 10 and orders are accepted in multiples of the minimum order.

*2. PYP-18 and PYP-36 can be cut to any required length.

Ratings and Specifications

Ratings

Standard Models with Built-in Operation Indicators

Operating Coil, Single-pole and Double-pole Models

| Item | Rated voltage (V) | Rated current (mA) | | Coil resistance (Ω) | Coil inductance (H) | | Must-operate voltage (V) | Must-release voltage (V) | Maximum voltage (V) | Power consumption (VA, W) |
|------|-------------------|--------------------|---------|---------------------|---------------------|-------------|--------------------------|--------------------------|-----------------------|-------------------------------|
| | | 50 Hz | 60Hz | | Armature OFF | Armature ON | | | | |
| AC | 12 | 106.5 | 91 | 46 | 0.17 | 0.33 | 80% max.*1 | 30% min.*2 | 110% of rated voltage | Approx. 1.0 to 1.2 (at 60 Hz) |
| | 24 | 53.8 | 46 | 180 | 0.69 | 1.3 | | | | |
| | 50 | 25.7 | 22 | 788 | 3.22 | 5.66 | | | | |
| | 100/110 | 11.7/12.9 | 10/11 | 3,750 | 14.54 | 24.6 | | | | Approx. 0.9 to 1.1 (at 60 Hz) |
| | 110/120 | 9.9/10.8 | 8.4/9.2 | 4,430 | 19.2 | 32.1 | | | | |
| | 200/220 | 6.2/6.8 | 5.3/5.8 | 12,950 | 54.75 | 94.07 | | | | |
| | 220/240 | 4.8/5.3 | 4.2/4.6 | 18,790 | 83.5 | 136.4 | | | | |
| DC | 6 | 150 | | 40 | 0.16 | 0.33 | 80% max.*1 | 10% min.*2 | 110% of rated voltage | Approx. 0.9 |
| | 12 | 75 | | 160 | 0.73 | 1.37 | | | | |
| | 24 | 36.9 | | 650 | 3.2 | 5.72 | | | | |
| | 48 | 18.5 | | 2,600 | 10.6 | 21.0 | | | | |
| | 100/110 | 9.1/10 | | 11,000 | 45.6 | 86.2 | | | | |

3 poles

| Item | Rated voltage (V) | Rated current (mA) | | Coil resistance (Ω) | Coil inductance (H) | | Must-operate voltage (V) | Must-release voltage (V) | Maximum voltage (V) | Power consumption (VA, W) |
|------|-------------------|--------------------|-----------|---------------------|---------------------|-------------|--------------------------|--------------------------|-----------------------|-------------------------------|
| | | 50 Hz | 60Hz | | Armature OFF | Armature ON | | | | |
| AC | 12 | 159 | 134 | 24 | 0.12 | 0.21 | 80% max.*1 | 30% min.*2 | 110% of rated voltage | Approx. 1.6 to 2.0 (at 60 Hz) |
| | 24 | 80 | 67 | 100 | 0.44 | 0.79 | | | | |
| | 100/110 | 14.1/16 | 12.4/13.7 | 2,300 | 10.5 | 18.5 | | | | |
| | 200/220 | 9.0/10.0 | 7.7/8.5 | 8,650 | 34.8 | 59.5 | | | | |
| DC | 12 | 112 | | 107 | 0.45 | 0.98 | 80% max.*1 | 10% min.*2 | 110% of rated voltage | Approx. 1.4 |
| | 24 | 58.6 | | 410 | 1.89 | 3.87 | | | | |
| | 48 | 28.2 | | 1,700 | 8.53 | 13.9 | | | | |
| | 100/110 | 12.7/13 | | 8,500 | 29.6 | 54.3 | | | | |

4 poles

| Item | Rated voltage (V) | Rated current (mA) | | Coil resistance (Ω) | Coil inductance (H) | | Must-operate voltage (V) | Must-release voltage (V) | Maximum voltage (V) | Power consumption (VA, W) |
|------|-------------------|--------------------|----------|---------------------|---------------------|-------------|--------------------------|--------------------------|-----------------------|--------------------------------|
| | | 50 Hz | 60Hz | | Armature OFF | Armature ON | | | | |
| AC | 12 | 199 | 170 | 20 | 0.1 | 0.17 | 80% max.*1 | 30% min.*2 | 110% of rated voltage | Approx. 1.95 to 2.5 (at 60 Hz) |
| | 24 | 93.6 | 80 | 78 | 0.38 | 0.67 | | | | |
| | 100/110 | 22.5/25.5 | 19/21.8 | 1,800 | 10.5 | 17.3 | | | | |
| | 200/220 | 11.5/13.1 | 9.8/11.2 | 6,700 | 33.1 | 57.9 | | | | |
| DC | 12 | 120 | | 100 | 0.39 | 0.84 | 80% max.*1 | 10% min.*2 | 110% of rated voltage | Approx. 1.5 |
| | 24 | 69 | | 350 | 1.41 | 2.91 | | | | |
| | 48 | 30 | | 1,600 | 6.39 | 13.6 | | | | |
| | 100/110 | 15/15.9 | | 6,900 | 32.0 | 63.7 | | | | |

Note: 1. The rated current and coil resistance are measured at a coil temperature of 23°C with tolerances of +15%/–20% for the AC rated current and ±15% for the DC coil resistance.

2. The AC coil resistance and inductance values are reference values only. (at 60 Hz).

3. Operating characteristics were measured at a coil temperature of 23°C.

4. The maximum voltage capacity was measured at an ambient temperature of 23°C.

*1. There is variation between products, but actual values are 80% max.

To ensure operation, apply at least 80% of the rated value (at a coil temperature of +23° C).

*2. The actual values are 30% min. for AC and 10% min. for DC. To ensure release, use a value that is lower than the specified value.

Refer to *List of Certified Models* for a list of models that are certified for safety standards and the Electrical Appliances and Material Safety Act.

| Item | Classification | 1 pole | | Double-, 3-, and 4-pole models | | Bifurcated contacts | |
|-------------------------|----------------|-----------------------------------|---|-----------------------------------|---|---------------------------------|---|
| | | Resistive load | Inductive load (cos φ = 0.4, L/R = 7 ms) | Resistive load | Inductive load (cos φ = 0.4, L/R = 7 ms) | Resistive load | Inductive load (cos φ = 0.4, L/R = 7 ms) |
| Contact type | | Single | | | | Bifurcated | |
| Contact materials | | Ag alloy | | | | | |
| Rated load | | 15 A at 110 VAC 15 A at 24 VDC | 10 A at 110 VAC 7 A at 24 VDC | 10 A at 110 VAC 10 A at 24 VDC | 7.5 A at 110 VAC 5 A at 24 VDC | 5 A at 110 VAC 5 A at 24 VDC | 4 A at 110 VAC 4 A at 24 VDC |
| Rated carry current | | 15 A | | 10 A | | 7 A | |
| Maximum contact voltage | | 250 VAC 125 VDC | | 250 VAC 125 VDC | | 250 VAC 125 VDC | |
| Maximum contact current | | 15 A | 15 A | 10 A | 10 A | 7 A | 7 A |

| Item | Type | Single-pole and double-pole models (standard models and bifurcated contact models) | Single-pole, double-pole models (models with built-in operation indicators, models with built-in diodes, and models with built-in CR circuits), 3-pole and 4-pole models |
|-------------------------------|------|---|--|
| Ambient operating temperature | | -25 to 55°C (with no icing or condensation)*1 | -25 to +40°C (with no icing or condensation)*2 |
| Ambient operating humidity | | 5% to 85% | |

- Note:**
- Some models in the LY1 and LY2 Series have an upper temperature limit of +40°C. This limitation is due to the diode junction temperature and the elements used. Refer to *Ambient Temperature vs. Coil Temperature Rise in Engineering Data* on page 8 to 9 for information on operation in temperature conditions that are not described here.
 - When you apply a minimum of 10 A of current to an LY1 when it is used in combination with a PTF08A, PTF08A-E, or PT08, connect each of the following terminal pairs: (1) to (2), (3) to (4), and (5) to (6).
- *1. If the carry current is 4 A or less, the usable ambient temperature range is -25 to 70° C.
*2. If the flowing current is 4 A or less, the usable ambient temperature range is -25 to 55° C.

Characteristics

| Item | Type | Standard models, models with built-in operation indicators, models with built-in CR circuits, and models with built-in diodes | Bifurcated contacts |
|--|--|---|--|
| Contact resistance*1 | | 50 mΩ max. | |
| Operating time*2 | | 25 ms max. | |
| Release time*2 | | 25 ms max. | |
| Maximum operating frequency | Mechanical | 18,000 operations/h | |
| | Rated load | 1,800 operations/h | |
| Insulation resistance*3 | | 100 MΩ min. | |
| Dielectric strength | Between coil and contacts | 2,000 VAC at 50/60 Hz for 1 min. | |
| | Between contacts of different polarity | 2,000 VAC at 50/60 Hz for 1 min. | |
| | Between contacts of the same polarity | 1,000 VAC at 50/60 Hz for 1 min. | |
| Vibration resistance | Destruction | 10 to 55 to 10 Hz, 0.5-mm single amplitude (1.0-mm double amplitude) | |
| | Malfunction | 10 to 55 to 10 Hz, 0.5-mm single amplitude (1.0-mm double amplitude) | |
| Shock resistance | Destruction | 1,000 m/s ² | |
| | Malfunction | 200 m/s ² | |
| Endurance | Mechanical | AC: 50,000,000 operations min. DC: 100,000,000 operations min. | (switching frequency: 18,000 operations/h) |
| | Electrical*4 | 1-, 3-, 4-pole: 200,000 operations min. 2-pole: 500,000 operations min. (rated load, operating frequency: 1,800 operations/h) | 2-pole: 500,000 operations min. (rated load, operating frequency: 1,800 operations/h) |
| Failure rate P value (reference value)*5 | | 100 mA at 5 VDC | 10mA at 5 VDC |
| Weight | | 1-pole and 2-pole: 40 g, 3-pole: Approx. 50 g, 4-pole: Approx. 70 g | |

- Note:** The values at the left are initial values.
- *1. Measurement conditions: 1 A at 5 VDC using the voltage drop method
*2. Measurement conditions: With rated operating power applied, not including contact bounce. Ambient temperature condition: 23° C
*3. Measurement conditions: For 500 VDC applied to the same location as for dielectric strength measurement.
*4. Ambient temperature condition: 23° C
*5. This value was measured at a switching frequency of 120 operations per minute.

Endurance Under Real Loads (Reference Only)

| Item | Load type | LY1, 100 VAC | | | LY2, 100 VAC | | | LY4, 100 VAC | | |
|----------------------|--|---------------------------|---------------------|--|---------------------------|---------------------|---|---------------------------|---|---|
| | | Conditions | Operating frequency | Electrical life (x10,000 operations min.) | Conditions | Operating frequency | Electrical life (x10,000 operations min.) | Conditions | Operating frequency | Electrical life (x10,000 operations min.) |
| AC motor | 400 W, 100 VAC single-phase with 35-A inrush current, 7-A current flow | ON for 10 s, OFF for 50 s | 5 | 200 W, 100 VAC single-phase with 25-A inrush current, 5-A current flow | ON for 10 s, OFF for 50 s | 20 | 200 W, 200 VAC three-phase with 5-A inrush current, 1-A current flow | ON for 10 s, OFF for 50 s | 50 | |
| | | | | | | | 750 W, 200 VAC three-phase with 18-A inrush current, 3.5-A current flow | | 7 | |
| AC lamp | 300 W, 100 VAC with 51-A inrush current, 3-A current flow | ON for 5 s, OFF for 55 s | 10 | 300 W, 100 VAC with 51-A inrush current, 3-A current flow | ON for 5 s, OFF for 55 s | 8 | 300 W, 100 VAC with 51-A inrush current, 3-A current flow | ON for 5 s, OFF for 55 s | 5 | |
| | 500 W, 100 VAC with 78-A inrush current, 5-A current flow | | 2.5 | | | | | | | |
| Capacitor (2,000 μF) | 24 VDC with 50-A inrush current, 1-A current flow | ON for 1 s, OFF for 6 s | 10 | 24 VDC with 50-A inrush current, 1-A current flow | ON for 1 s, OFF for 15 s | 1 | 24 VDC with 50-A inrush current, 1-A current flow | ON for 1 s, OFF for 15 s | 0.5 | |
| | | | | 24 VDC with 20-A inrush current, 1-A current flow | | | 15 | | 24 VDC with 20-A inrush current, 1-A current flow | 20 |
| AC solenoid | 50 VA with 2.5-A inrush current, 0.25-A current flow | ON for 1 s, OFF for 2 s | 150 | 50 VA with 2.5-A inrush current, 0.25-A current flow | ON for 1 s, OFF for 2 s | 100 | 50 VA with 2.5-A inrush current, 0.25-A current flow | ON for 1 s, OFF for 2 s | 100 | |
| | 100 VA with 5-A inrush current, 0.5-A current flow | | 80 | 100 VA with 5-A inrush current, 0.5-A current flow | | | 50 | | | |

Details on Safety-standard-certified Models, LY□

- Standard models are certified for the UL, CSA, and SEV safety standards.
- Refer to *Model Number Structure* on page 1 for a list of applicable models.
- The rated values for safety standard certification are not the same as individually defined performance values. Always check the specifications before use.

UL-certified Models (File No. E41643)

| Model | Coil ratings | Number of poles | Contact ratings | Certified number of operations |
|-------|----------------------------|-----------------|--|--------------------------------|
| LY | 6 to 240VAC 6 to 125VDC | 1 | 15A, 120VAC (General use) | 100,000 operations |
| | | | 15A, 240VAC (General use) | 6,000 operations |
| | | | 15A, 30VDC (Resistive) | |
| | | | 1/2HP, 120VAC | 100,000 operations |
| | | | 8.5FLA, 30LRA, 120VAC | 25,000 operations |
| | | | TV-5, 120VAC | |
| | | | 470VA, Pilot duty, 120VAC | |
| | 6 to 240VAC 6 to 125VDC | 2 | 15A, 120VAC (General use) | 100,000 operations |
| | | | 12A, 240VAC (General use) | 6,000 operations |
| | | | 7A, 250VAC (General use) | |
| | | | 15A, 30VDC (Resistive) | |
| | | | 5A, 38VDC (Resistive) | |
| | | | 1/2HP, 120VAC | 100,000 operations |
| | | | 1/3HP, 240VAC | 1,000 operations |
| | | | 8.5FLA, 30LRA, 120VAC | 100,000 operations |
| | | | 5FLA, 50LRA, 50VDC | 25,000 operations |
| | | | TV-3, 120VAC | |
| | | | 345VA, Pilot duty, 120-240VAC | |
| | | | B300/R300 | 6,000 operations |
| | | | | |
| | 6 to 240VAC 6 to 125VDC | 3 4 | 10A, 240VAC (General use) (Same polarity) | 6,000 operations |
| | | | 10A, 30VDC (General use) (Same polarity) | |
| | | | 2A, 40VDC (Resistive) (Same polarity) | 1,000 operations |
| | | | 1/2HP, 240VAC | |
| | | | 0.6A, 100VDC (Resistive) (Same polarity) | |

CSA-certified Models (File No. LR31928)

| Model | Coil ratings | Number of poles | Contact ratings | Certified number of operations |
|-------|----------------------------|-----------------|--|--------------------------------|
| LY | 6 to 240VAC 6 to 125VDC | 1 | 15A, 120VAC (General use) | 100,000 operations |
| | | | 15A, 240VAC (General use) | 6,000 operations |
| | | | 15A, 30VDC (Resistive) | |
| | | | 1/2HP, 120VAC | 100,000 operations |
| | | | 8.5FLA, 30LRA, 120VAC | 25,000 operations |
| | | | TV-5, 120VAC | |
| | | | 470VA, Pilot duty, 120VAC | |
| | 6 to 240VAC 6 to 125VDC | 2 | 15A, 120VAC (General use) | 6,000 operations |
| | | | 12A, 240VAC (General use) | |
| | | | 7A, 250VAC (General use) | |
| | | | 15A, 30VDC (Resistive) | |
| | | | 5A, 38VDC (Resistive) | 100,000 operations |
| | | | 1/2HP, 120VAC | |
| | | | 1/3HP, 240VAC | |
| | | | 8.5FLA, 30LRA, 120VAC | 100,000 operations |
| | | | 5FLA, 50LRA, 50VDC | 25,000 operations |
| | | | TV-3, 120VAC | |
| | | | 345VA, Pilot duty, 120-240VAC | |
| | | | B300/R300 Pilot duty | 6,000 operations |
| | | | | |
| | 6 to 240VAC 6 to 125VDC | 3 4 | 10A, 240VAC (General use) (Same polarity) | 6,000 operations |
| | | | 10A, 30VDC (Resistive) (Same polarity) | |
| | | | 1/8HP, 240VAC (Same polarity) | 1,000 operations |
| | | | 1/2HP, 240VAC (Same polarity) | |
| | | | 1/3HP, 240VAC (Same polarity) | |
| | | | 2A, 40VDC (Resistive) | 6,000 operations |
| | | | 0.6A, 100VDC (Resistive) | |

TÜV-certified Models (File No. R50030064, EN 61810-1)

| Model | Coil ratings | Number of poles | Contact ratings | Certified number of operations | |
|-------|------------------------------|-----------------|------------------------------|--------------------------------|--------------------|
| LY□ | 6 to 240 VAC 6 to 110 VDC | 1 | 15 A, 110 VDC resistive load | 200,000 operations | |
| | | | 10 A, 110 VAC inductive load | | |
| | | | 10 A, 250 VAC resistive load | | |
| | | | 7A, 250 VAC inductive load | | |
| | | | 10 A, 30 VDC resistive load | | |
| | | | 7 A, 30 VDC inductive load | | |
| | | | 10 A, 110 VAC resistive load | | |
| | | 2 | 7.5A, 110 VAC inductive load | | |
| | | | 7A, 250 VAC resistive load | | |
| | | | 4 A, 250 VAC inductive load | | |
| | | | 7 A, 30 VDC resistive load | | |
| | | | 4 A, 30 VDC inductive load | | |
| | | 3 4 | 10 A, 110 VAC resistive load | | 100,000 operations |
| | | | 7.5A, 110 VAC inductive load | | |

SEV-certified Models (File No. 11, 0573)

| Model | Coil ratings | Number of poles | Contact ratings | Certified number of operations |
|-------|------------------------------|-----------------|-----------------|--------------------------------|
| LY□ | 6 to 110 VDC 2 to 240 VAC | 1 | 15 A at 24 VDC | 6,000 operations |
| | | | 15 A at 220 VAC | |
| | 6 to 110 VDC 2 to 240 VAC | 2 to 4 | 10 A at 24 VDC | |
| | | | 10 A at 220 VAC | |

- When ordering a model that is certified for VDE or Lloyd's Register (LR) standards, always specify "VDE-certified Model" or "LR Standard-certified Model" with your order.

VDE Certification (Certificate No. 6359, EN 61810-1)

| Model | Coil ratings | Number of poles | Contact ratings | Certified number of operations |
|--------|---|-----------------|------------------------------|--------------------------------|
| LY□-VD | 6, 12, 24, 50, 110, or 220 VAC 6, 12, 24, 48, or 110 VDC | 1 | 10 A, 220 VAC resistive load | 200,000 operations |
| | | | 7 A, 220 VAC inductive load | |
| | | | 10 A, 28 VDC resistive load | |
| | | | 7 A, 28 VDC inductive load | |
| | | 2 | 7 A, 220 VAC resistive load | |
| | | | 4 A, 220 VAC inductive load | |
| | | | 7 A, 28 VDC resistive load | |
| | | | 4 A, 28 VDC inductive load | |

LR-certified Models (File No. 00/10047)

| Model | Coil ratings | Number of poles | Contact ratings |
|-------|------------------------------|-----------------|-------------------------------|
| LY□ | 6 to 240 VAC 6 to 110 VDC | 2 | 7.5 A, 230 VAC inductive load |
| | | 4 | 5 A, 24 VDC inductive load |

Details on Safety-standard-certified Models, Sockets

UL-certified Models (File No. E87929) 

| Model | Ratings | Standard number | Category | Listed/Recognized |
|--------------------------------------|----------|-----------------|----------|-------------------|
| PTF08A(-E) PT08 | 15A 250V | UL508 | SWIV2 | Recognized |
| PTF14A(-E) PT11 PT14 PTF11A | 10A 250V | | | |

CSA-certified Models (File No. LR31928) 

| Model | Ratings | Standard number | Class number |
|----------------------|-------------|-------------------|--------------|
| PTF08A(-E) | 15A 240V AC | CSA C22.2 (No.14) | 3211 07 |
| PTF11A PTF14A(-E) | 10A 240V AC | | |

CE Marking Compliance

| Model | EMC Directive | Low Voltage Directive | Machinery Directive | Safety Category |
|--------------------------|----------------|-----------------------|---------------------|-----------------|
| PTF08A(-E) PTF14A(-E) | Not applicable | ○ | Not applicable | 1 |

- Note:** 1. CE compliance is achieved when used with a relay (LY).
 2. The Safety Category refers to the maximum applicable category selected when constructing control system safety components. The category does not apply to individual components.

Compliance with Electrical Appliances and Material Safety Act, LY□

All standard models comply with the Electrical Appliances and Material Safety Act.

| Model | Coil ratings | Number of poles | Contact ratings |
|-------|------------------------------|-----------------|-----------------|
| LY□ | 6 to 240 VAC 6 to 120 VDC | 1 | 15 A at 200 VAC |
| | | 2 | 10A at 200 VAC |
| | | 3 | |
| | | 4 | |

Engineering Data

Engineering Data

Maximum Switching Capacity LY1

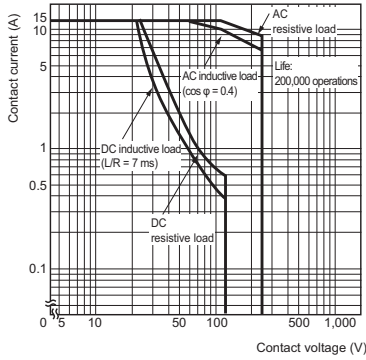

LY2

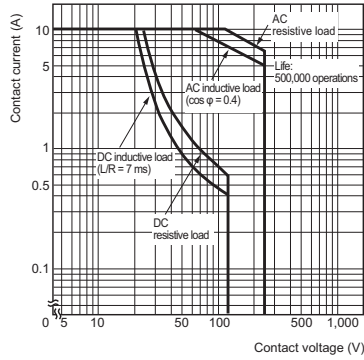

LY3 and LY4

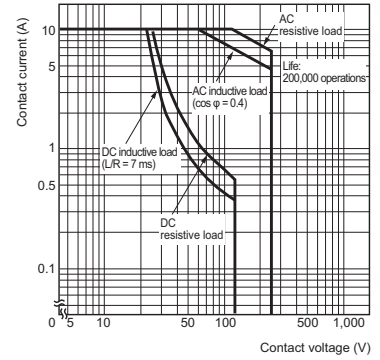

LY2Z

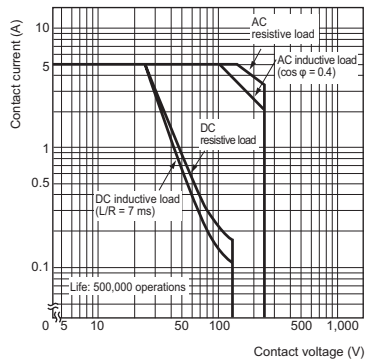

Endurance Curve

LY1

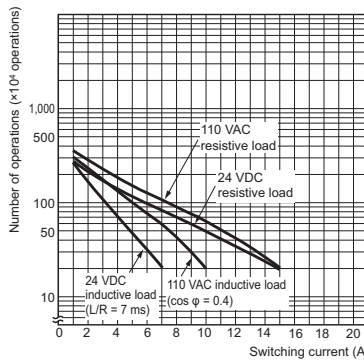

LY2

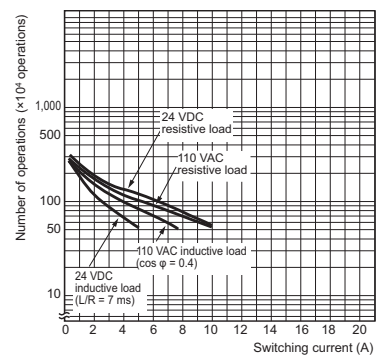

LY3 and LY4

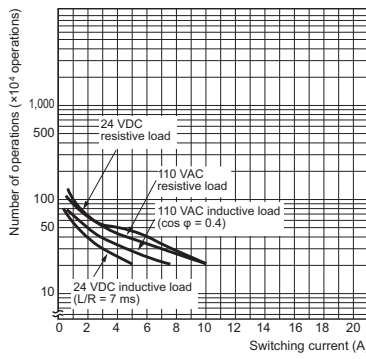

LY2Z

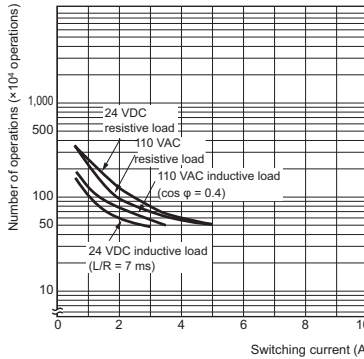

Ambient Temperature vs. Must-operate and Must-release Voltage LY2 100/110 VAC at 50Hz

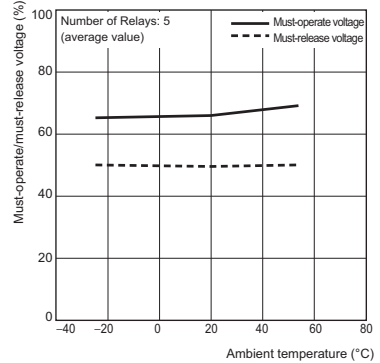

Ambient Temperature vs. Coil Temperature Rise

LY2 24 VDC

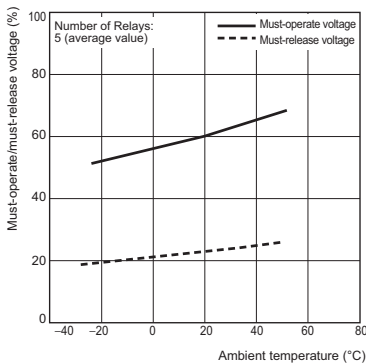

LY1 24 VDC

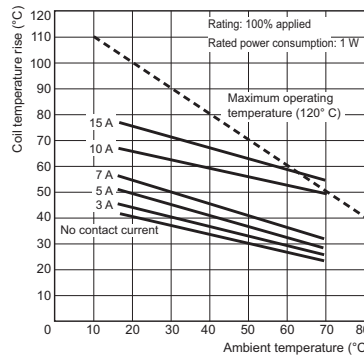

LY1 100/110 VAC at 50Hz

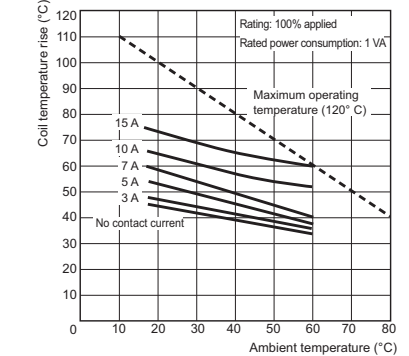

LY2 24 VDC

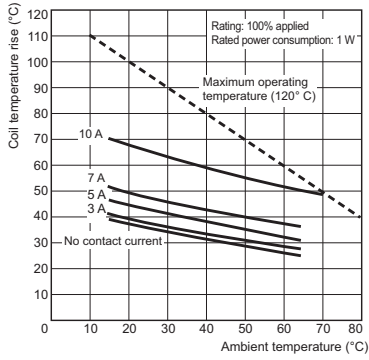

LY2 100/110 VAC at 50Hz

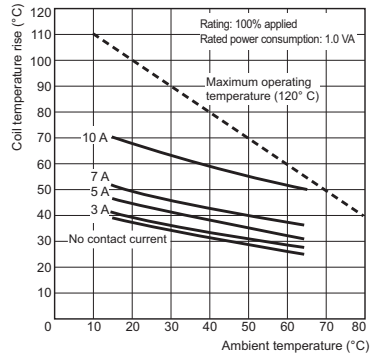

LY3 24 VDC

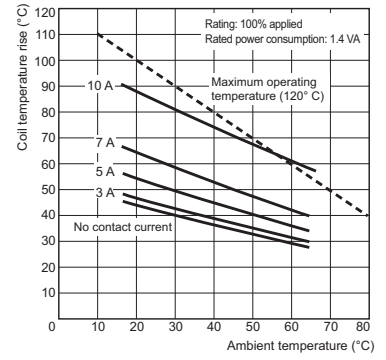

LY3 100/110 VAC at 50Hz

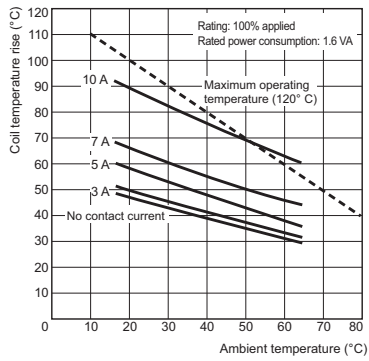

LY4 24 VDC

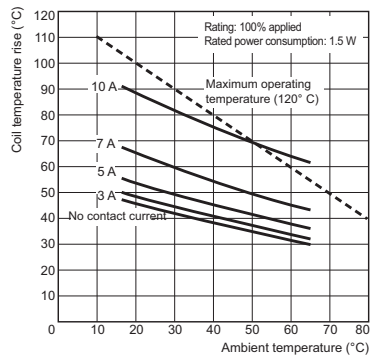

LY4 100/110 VAC at 50Hz

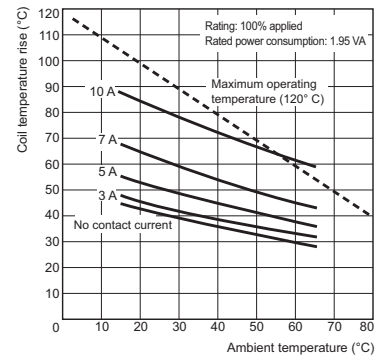

Models with built-in diodes

The diode absorbs surge from the coil.

With Diode

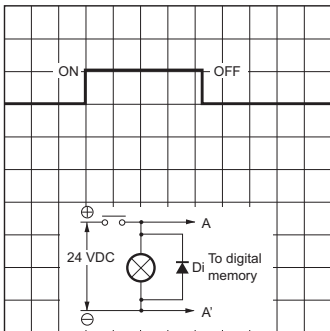

Without Diode

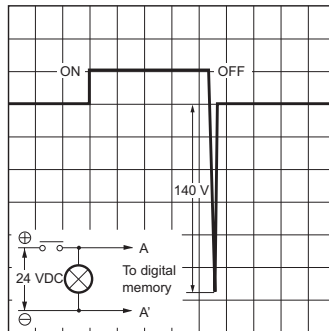

- Note:**
1. Make sure that the polarity is correct.
 2. The release time will increase, but the 25-ms specification for standard models is satisfied.
 3. Diode characteristics:
Reversed dielectric strength: 1,000 V
Forward current: 1 A

Models with Built-in CR Circuits

With CR

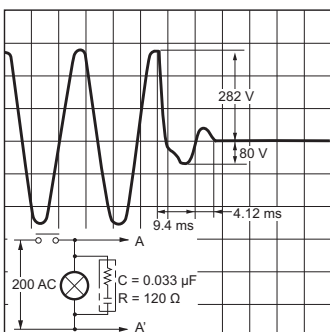

Without CR

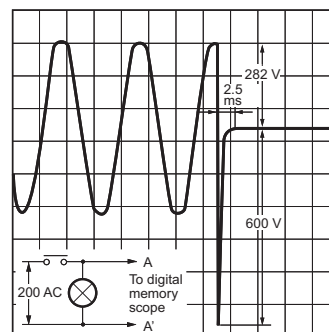

Malfunctioning Shock
LY2 100/110 VAC

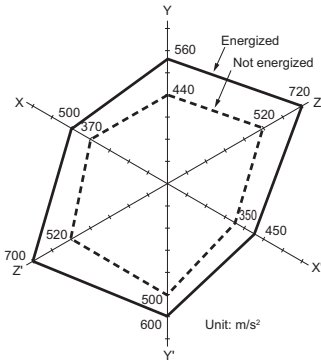

N = 20
Measurement: Shock was applied 2 times each in 6 directions along 3 axes with the Relay energized and not energized to check the shock values that cause the Relay to malfunction.
Criteria: Non-energized: 200 m/s² , Energized: 200 m/s²

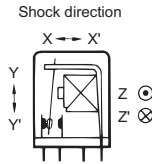

Dimensions

(Unit: mm)

Relays
Solder terminals

LY1
LY1N
LY1-D
LY1N-D2

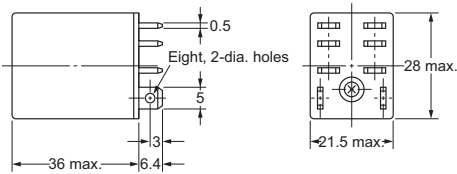
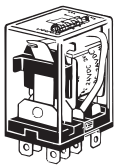

- Note:**
1. For the DC models, check the coil polarity when wiring and wire all connections correctly.
 2. The indicator is red for AC and green for DC.
 3. The operation indicator indicates the energization of the coil and does not represent contact operation.

Terminal Arrangement/Internal Connections (Bottom View)

LY1

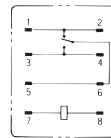

(The coil has no polarity.)

LY1N-D

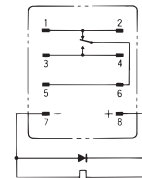

(Check the coil polarity when wiring and wire all connections correctly.)

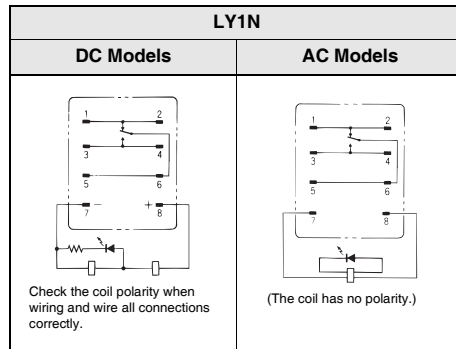

LY1N-D2

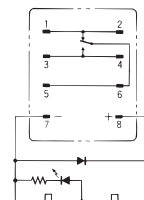

Check the coil polarity when wiring and wire all connections correctly.

LY2
LY2Z
LY2N
LY2ZN

LY2-D
LY2Z-D
LY2N-D2
LY2ZN-D2

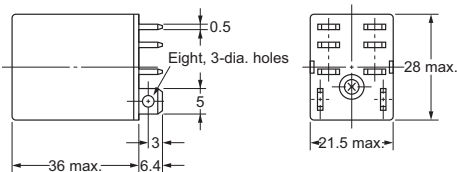
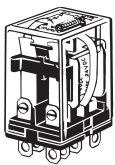

- Note:**
1. For the DC models, check the coil polarity when wiring and wire all connections correctly.
 2. The indicator is red for AC and green for DC.
 3. The operation indicator indicates the energization of the coil and does not represent contact operation.

Terminal Arrangement/Internal Connections (Bottom View)

LY2(Z)

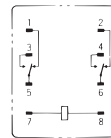

(The coil has no polarity.)

LY2(Z)-D

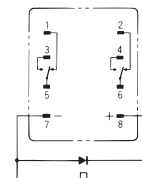

Check the coil polarity when wiring and wire all connections correctly.

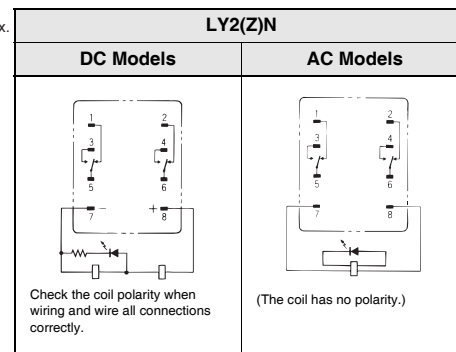

LY2(Z)N-D2

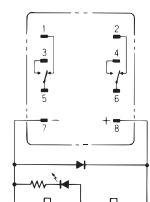

Check the coil polarity when wiring and wire all connections correctly.

LY3
LY3N
LY3-D
LY3N-D2

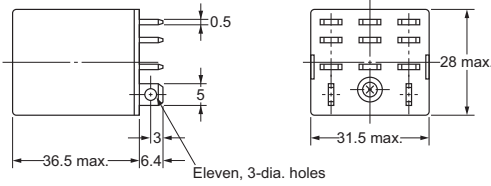
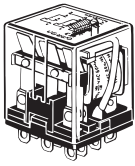

Terminal Arrangement/Internal Connections (Bottom View)
LY3

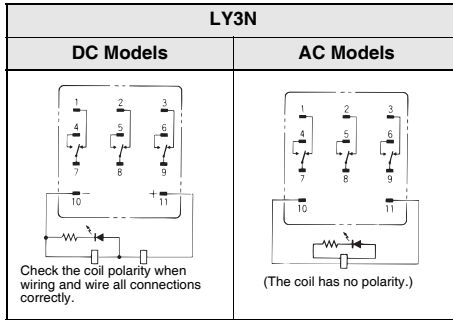
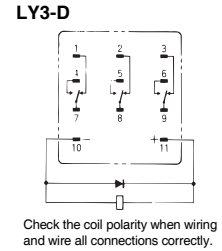
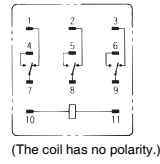

LY3N-D2

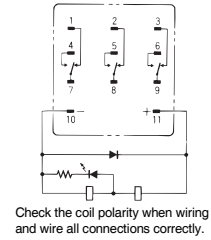

- Note:**
1. For the DC models, check the coil polarity when wiring and wire all connections correctly.
 2. The indicator is red for AC and green for DC.
 3. The operation indicator indicates the energization of the coil and does not represent contact operation.

LY4
LY4N
LY4-D
LY4N-D2

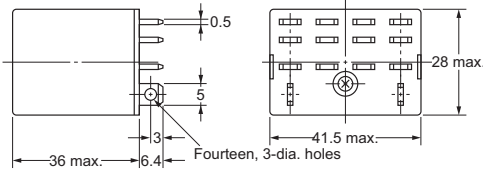
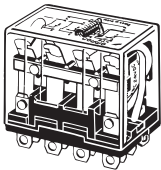

Terminal Arrangement/Internal Connections (Bottom View)

LY4

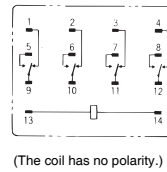

LY4-D

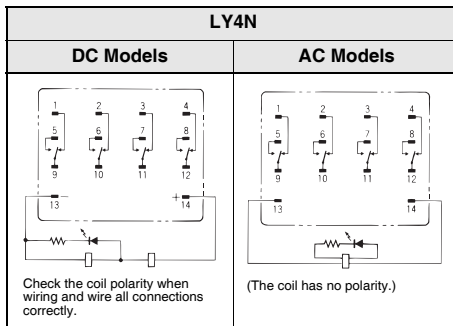
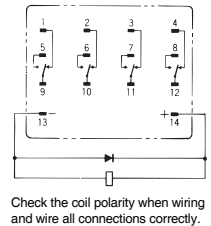

LY4N-D2

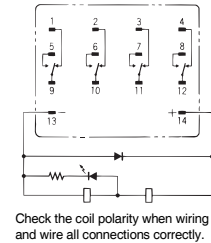

- Note:**
1. For the DC models, check the coil polarity when wiring and wire all connections correctly.
 2. The indicator is red for AC and green for DC.
 3. The operation indicator indicates the energization of the coil and does not represent contact operation.

LY2-CR
LY2Z-CR
LY2N-CR
LY2ZN-CR

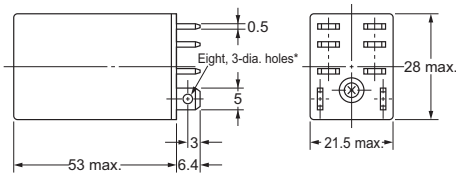

*These dimensions are for the LY2N-CR.

Terminal Arrangement/Internal Connections (Bottom View)

LY2(Z)-CR

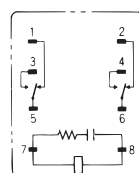

LY2(Z)N-CR

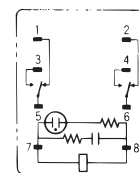

CR element
C = 0.033 μF
R = 120 Ω

(The coil has no polarity.)

Relays with PCB Terminals

LY1-0, LY3-0,
LY2-0, and LY4-0

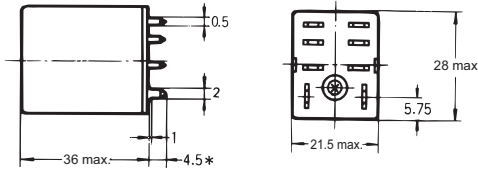
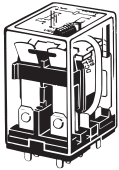

PCB Processing Dimensions (Bottom View)

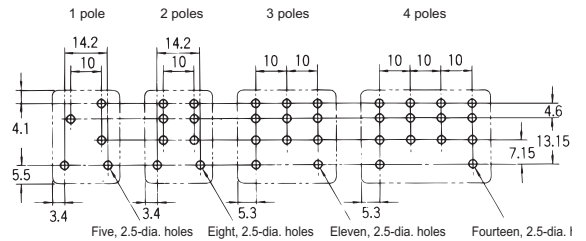

Note: The figures and dimensions depicted here are for the LY2-0. The dimension with an asterisk (*) is 6.4 for the LY1-0.

Note: 1. The dimensional tolerance is 0.1 mm.
2. There are exposed parts (conductive parts) on the LY1-0 other than the terminals. Be careful when using this Relay on a double-sided PCBs.

Terminal Arrangement/Internal Connections (Bottom View)

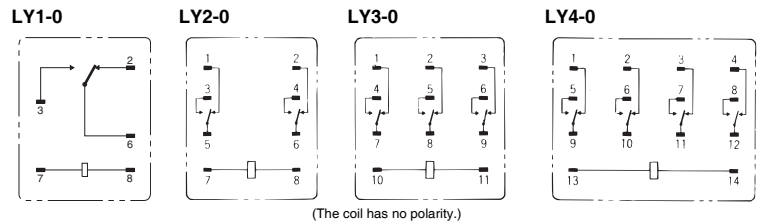

Case-surface mounting

LY1F
LY2F

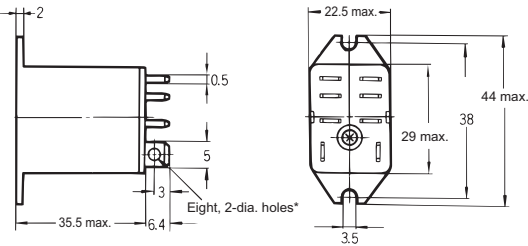
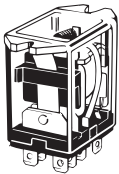

Mounting Hole Dimensions

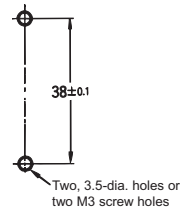

Terminal Arrangement/Internal Connections (Bottom View)

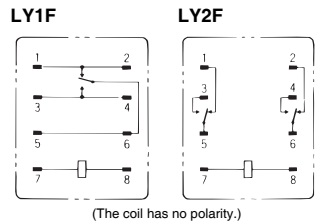

Note: The figures and dimensions depicted here are for the LY1F. The LY2F is also conforms to these measurements.

Note: The dimensional tolerance is ±0.1 mm.

LY3F

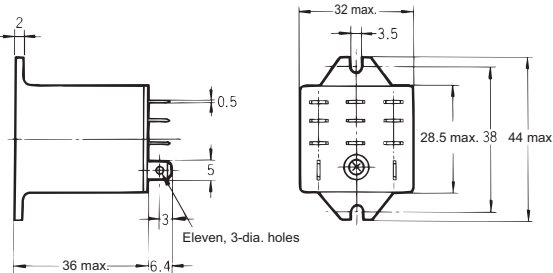
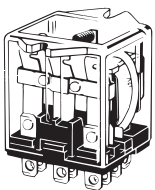

Mounting Hole Dimensions

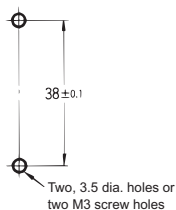

Terminal Arrangement/Internal Connections (Bottom View)

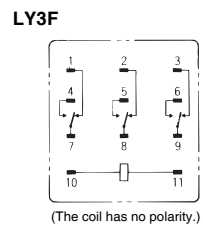

LY4F

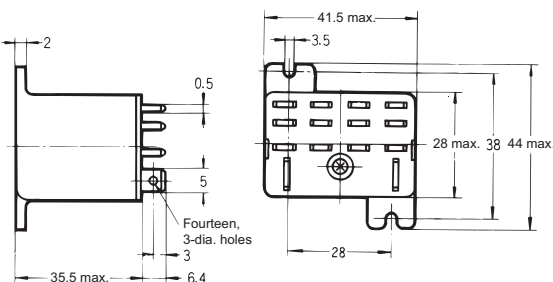
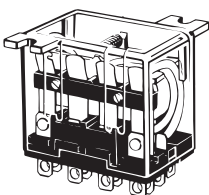

Mounting Hole Dimensions

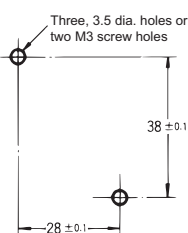

Terminal Arrangement/Internal Connections (Bottom View)

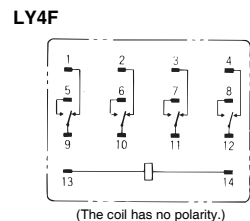

Connection Sockets

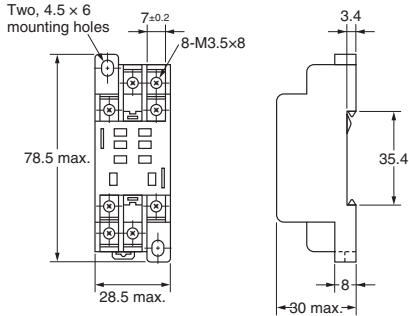
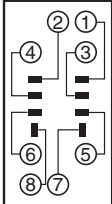
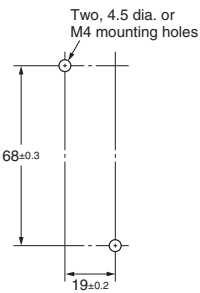
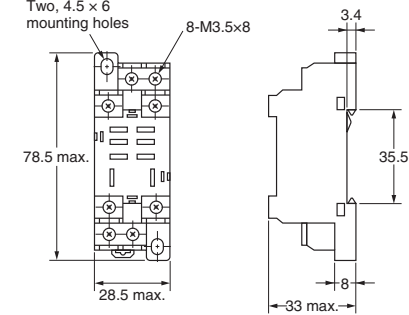
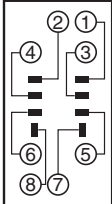
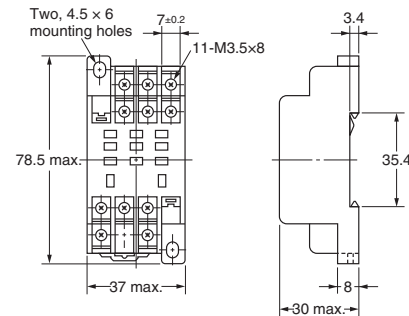
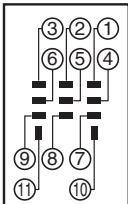
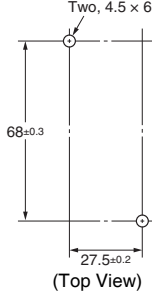
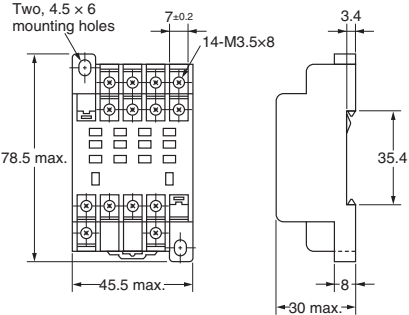
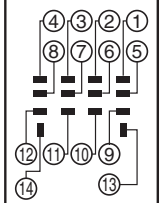
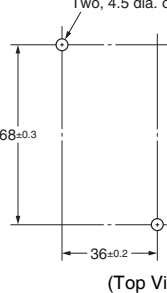
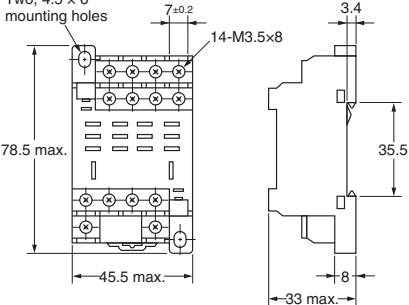
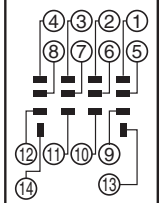
| Dimensions | Terminal Arrangement/ Internal Connections | Mounting Hole Dimensions |
|--|--|--|
| <p>PTF08A</p>  |  <p>(Top View)</p> |  <p>(Top View)</p> |
| <p>PTF08A-E (Finger Protection Structure)</p>  |  <p>(Top View)</p> | <p>Note: Track mounting is also possible.</p> |
| <p>PTF11A</p>  |  <p>(Top View)</p> |  <p>(Top View)</p> <p>Note: Track mounting is also possible.</p> |
| <p>PTF14A</p>  |  <p>(Top View)</p> |  <p>(Top View)</p> <p>Note: Track mounting is also possible.</p> |
| <p>PTF14A-E (Finger Protection Structure)</p>  |  <p>(Top View)</p> | <p>Note: Track mounting is also possible.</p> |

Note: If you use the PTF08A, PTF08A-E, or PT08 with an LY1 Relay, connect the following terminal pairs: 1-2, 3-4, and 5-6 (for usage at 10 A or higher).

| Dimensions | | Terminal Arrangement/ Internal Connections | Mounting hole and PCB dimensions |
|--|----------------------|---|----------------------------------|
| <p>PT08</p> | <p>PT08QN</p> | <p>(Bottom View)</p> | |
| <p>PT08-0</p> <p>*Maintain a sufficient distance from the pattern when using double-sided PCBs. • The structure does not resist flux. Manual soldering is recommended for this product.</p> | | | <p>(Bottom View)</p> |
| <p>PT11</p> | <p>PT11QN</p> | <p>(Bottom View)</p> | |
| <p>PT11-0</p> <p>*Maintain a sufficient distance from the pattern when using double-sided PCBs. • The structure does not resist flux. Manual soldering is recommended for this product.</p> | | | <p>(Bottom View)</p> |
| <p>PT14</p> | <p>PT14QN</p> | <p>(Bottom View)</p> | |
| <p>PT14-0</p> <p>*Maintain a sufficient distance from the pattern when using double-sided PCBs. • The structure does not resist flux. Manual soldering is recommended for this product.</p> | | | <p>(Bottom View)</p> |

Note: Use a panel with a thickness of 1 to 2 mm when mounting a Socket on it.

Hold-down Clips

PYC-A1

Approx. 0.54 g (per clip)
One Set (2 Clips)

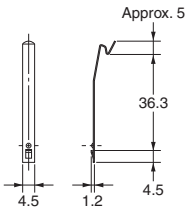

PYC-P

Approx. 1.4 g

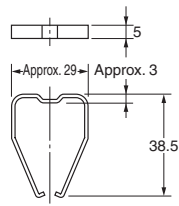

PYC-S

Approx. 1.8 g

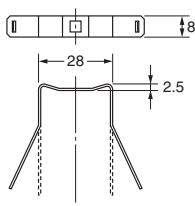

Y92H-3

Approx. 0.7 g (per clip)
One Set (2 Clips)

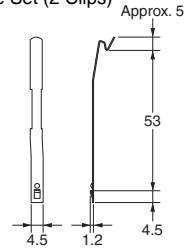

PYC-1

Approx. 6 g

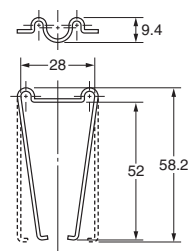

Socket Mounting Plates (t = 1.6)

OMRON can provide Socket Mounting Plate for convenient Socket installation. Please use these Plates as required.

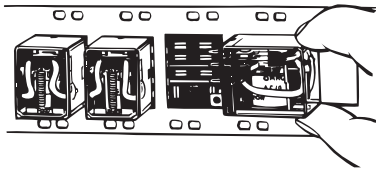

PYP-1

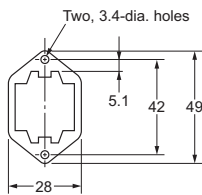

PYP-18

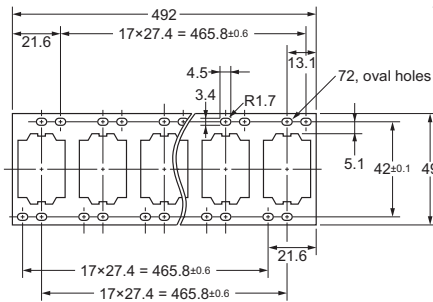

PYP-36

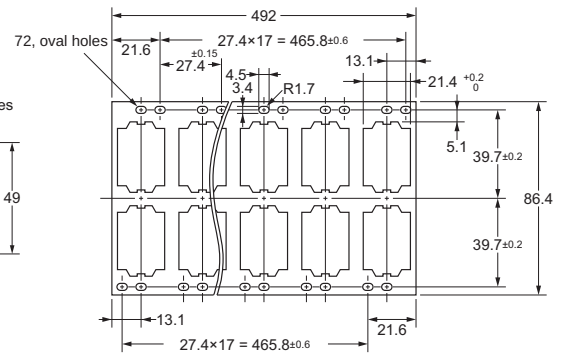

PTP-1-3

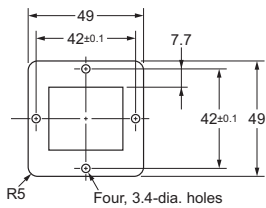

PTP-12

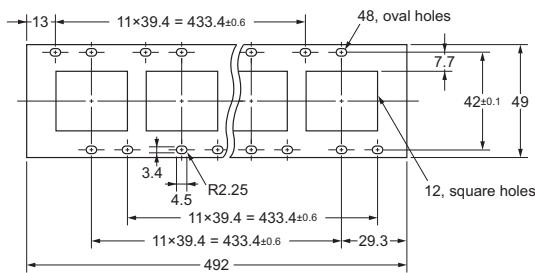

PTP-1

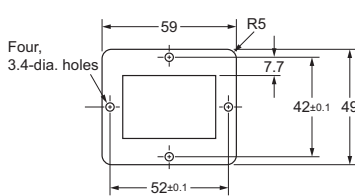

PTP-10

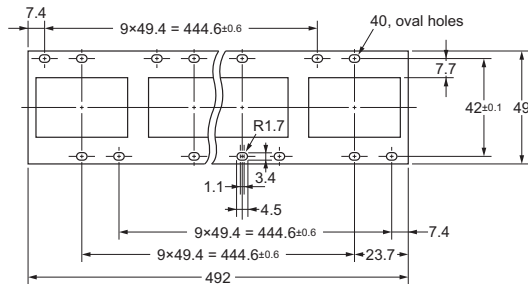

Connection Socket and Hold-down Clip Application Table

| Applicable Relay | Item Number of poles | Front-mounting Sockets | | | | Back-mounting Sockets | | | |
|---|-------------------------|-------------------------|--------|--------|----------------------------|--|--------------------|--------------------|----------------------------|
| | | Track or screw mounting | | | | Solder terminals, wrapping terminals, or PCB terminals | | | |
| | | PTF08A | PTF11A | PTF14A | Applicable Hold-down Clips | PT08(QN) PT08-0 | PT11(QN) PT11-0 | PT14(QN) PT14-0 | Applicable Hold-down Clips |
| <ul style="list-style-type: none"> Standard models: LY□ Bifurcated contact models: LY□Z Models with built-in operation indicators: LY□N Models with built-in diodes: LY□-D(2) | 1 or 2 | • | | | PYC-A1 | • | | | PYC-P |
| | 3 | | • | | | | • | | |
| | 4 | | | • | | | | | |
| <ul style="list-style-type: none"> Models with built-in CR circuits: LY□-CR | 2 | • | | | Y92H-3 | • | | | PYC-1 |

Mounting Height with Sockets

Front-mounting Sockets

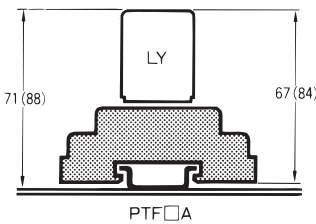

Back-mounting Sockets

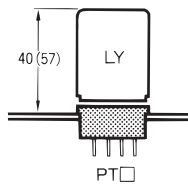

Note: 1. The PTF□A can be mounted on a track or with screws.
2. The measurements in parentheses are for the LY□-CR (built-in CR circuit).

Safety Precautions

Refer to the *Common Relay Precautions* for precautions that apply to all Relays.

Precautions for Correct Use

- Use two M3 screws to attach case-surface-mounted models (LY1F, LY2F, LY3F, and LY4F) and tighten the screws securely. (Normal tightening torque: 0.98 N·m)
- For Relays with Tab Terminals, select a wire diameter for the lead wires that connect to the faston receptacle terminals that is within the allowed range for the load current.
- Do not impose excessive external force on the Relay when inserting the Relay to the faston receptacle or pulling the Relay out from the faston receptacle. Do not attempt to insert a terminal diagonally or insert or pull out more than one terminal at the same time.
- LY Single-contact Relays are for power switching applications. Do not use the LY Series for switching minute loads of 100 mA or less, such as signals.

About the Built-in Diode and CR Elements

The diode or CR element that are built into the Relay are designed to absorb the reverse voltage from the Relay coil. If a large surge in voltage is applied to the diode or CR element from an external source, the element will be destroyed.

If there is the possibility of large voltage surges that could be applied to the elements from an external source, take any necessary surge absorption measures.

Applying 10 A or More When Using an LY Relay with the Following Sockets

When you use an LY-series relay in combination with the PTF08A, PTF08A-E, or PT08, connect each of the following terminal pairs: (1) to (2), (3) to (4), and (5) to (6).

Relay Replacement

To replace the Relay, turn OFF the power supply to the load and Relay coil sides to prevent unintended operation and possible electrical shock.

Attaching and Removing Relay Hold-down Clips

When you attach a Hold-down Clip to or remove it from a Socket, wear gloves or take other measures to prevent injuring your fingers on the Hold-down Clip.

Terms and Conditions Agreement

Read and understand this catalog.

Please read and understand this catalog before purchasing the products. Please consult your OMRON representative if you have any questions or comments.

Warranties.

(a) Exclusive Warranty. Omron's exclusive warranty is that the Products will be free from defects in materials and workmanship for a period of twelve months from the date of sale by Omron (or such other period expressed in writing by Omron). Omron disclaims all other warranties, express or implied.

(b) Limitations. OMRON MAKES NO WARRANTY OR REPRESENTATION, EXPRESS OR IMPLIED, ABOUT NON-INFRINGEMENT, MERCHANTABILITY OR FITNESS FOR A PARTICULAR PURPOSE OF THE PRODUCTS. BUYER ACKNOWLEDGES THAT IT ALONE HAS DETERMINED THAT THE PRODUCTS WILL SUITABLY MEET THE REQUIREMENTS OF THEIR INTENDED USE.

Omron further disclaims all warranties and responsibility of any type for claims or expenses based on infringement by the Products or otherwise of any intellectual property right. (c) Buyer Remedy. Omron's sole obligation hereunder shall be, at Omron's election, to (i) replace (in the form originally shipped with Buyer responsible for labor charges for removal or replacement thereof) the non-complying Product, (ii) repair the non-complying Product, or (iii) repay or credit Buyer an amount equal to the purchase price of the non-complying Product; provided that in no event shall Omron be responsible for warranty, repair, indemnity or any other claims or expenses regarding the Products unless Omron's analysis confirms that the Products were properly handled, stored, installed and maintained and not subject to contamination, abuse, misuse or inappropriate modification. Return of any Products by Buyer must be approved in writing by Omron before shipment. Omron Companies shall not be liable for the suitability or unsuitability or the results from the use of Products in combination with any electrical or electronic components, circuits, system assemblies or any other materials or substances or environments. Any advice, recommendations or information given orally or in writing, are not to be construed as an amendment or addition to the above warranty.

See <http://www.omron.com/global/> or contact your Omron representative for published information.

Limitation on Liability; Etc.

OMRON COMPANIES SHALL NOT BE LIABLE FOR SPECIAL, INDIRECT, INCIDENTAL, OR CONSEQUENTIAL DAMAGES, LOSS OF PROFITS OR PRODUCTION OR COMMERCIAL LOSS IN ANY WAY CONNECTED WITH THE PRODUCTS, WHETHER SUCH CLAIM IS BASED IN CONTRACT, WARRANTY, NEGLIGENCE OR STRICT LIABILITY.

Further, in no event shall liability of Omron Companies exceed the individual price of the Product on which liability is asserted.

Suitability of Use.

Omron Companies shall not be responsible for conformity with any standards, codes or regulations which apply to the combination of the Product in the Buyer's application or use of the Product. At Buyer's request, Omron will provide applicable third party certification documents identifying ratings and limitations of use which apply to the Product. This information by itself is not sufficient for a complete determination of the suitability of the Product in combination with the end product, machine, system, or other application or use. Buyer shall be solely responsible for determining appropriateness of the particular Product with respect to Buyer's application, product or system. Buyer shall take application responsibility in all cases.

NEVER USE THE PRODUCT FOR AN APPLICATION INVOLVING SERIOUS RISK TO LIFE OR PROPERTY OR IN LARGE QUANTITIES WITHOUT ENSURING THAT THE SYSTEM AS A WHOLE HAS BEEN DESIGNED TO ADDRESS THE RISKS, AND THAT THE OMRON PRODUCT(S) IS PROPERLY RATED AND INSTALLED FOR THE INTENDED USE WITHIN THE OVERALL EQUIPMENT OR SYSTEM.

Programmable Products.

Omron Companies shall not be responsible for the user's programming of a programmable Product, or any consequence thereof.

Performance Data.

Data presented in Omron Company websites, catalogs and other materials is provided as a guide for the user in determining suitability and does not constitute a warranty. It may represent the result of Omron's test conditions, and the user must correlate it to actual application requirements. Actual performance is subject to the Omron's Warranty and Limitations of Liability.

Change in Specifications.

Product specifications and accessories may be changed at any time based on improvements and other reasons. It is our practice to change part numbers when published ratings or features are changed, or when significant construction changes are made. However, some specifications of the Product may be changed without any notice. When in doubt, special part numbers may be assigned to fix or establish key specifications for your application. Please consult with your Omron's representative at any time to confirm actual specifications of purchased Product.

Errors and Omissions.

Information presented by Omron Companies has been checked and is believed to be accurate; however, no responsibility is assumed for clerical, typographical or proofreading errors or omissions.

X-ON Electronics

Largest Supplier of Electrical and Electronic Components

Click to view similar products for [General Purpose Relays](#) category:

Click to view products by [Omron](#) manufacturer:

Other Similar products are found below :

[APF30318](#) [JVN1AF-4.5V-F](#) [PCN-105D3MHZ](#) [5JO-10000S-SIL](#) [5JO-1000CD-SIL](#) [5JO-400CD-SIL](#) [LY2S-AC220/240](#) [LYQ20DC12](#)
[6031007G](#) [6131406HQ](#) [6-1393099-3](#) [6-1393099-8](#) [6-1393122-4](#) [6-1393123-2](#) [6-1393767-1](#) [6-1393843-7](#) [6-1415012-1](#) [6-1419102-2](#) [6-](#)
[1423698-4](#) [6-1608051-6](#) [6-1608067-0](#) [6-1616170-6](#) [6-1616248-2](#) [6-1616282-3](#) [6-1616348-2](#) [6-1616350-1](#) [6-1616350-8](#) [6-1616358-7](#) [6-](#)
[1616359-9](#) [6-1616360-9](#) [6-1616931-6](#) [6-1617039-1](#) [6-1617052-1](#) [6-1617090-2](#) [6-1617090-5](#) [6-1617347-5](#) [6-1617353-3](#) [6-1617801-8](#) [6-](#)
[1617802-2](#) [6-1618107-9](#) [6-1618248-4](#) [M83536/1-027M](#) [CX-4014](#) [MAHC-5494](#) [MAVCD-5419-6](#) [703XCX-120A](#) [7-1393100-5](#) [7-1393111-7](#)
[7-1393144-5](#) [7-1393767-8](#)