

# General Purpose Relay

# LY

- Arc barrier equipped.
- High dielectric strength (2,000 VAC).
- Long dependable service life assured by Ag-Alloy contacts.
- Choose models with single or bifurcated contacts, LED indicator, diode surge suppression, push-to-test button, or RC circuit.
- UL, CSA, and TUV approvals on all standard LY Relays.
- CE marks included on non-PCB mount versions.

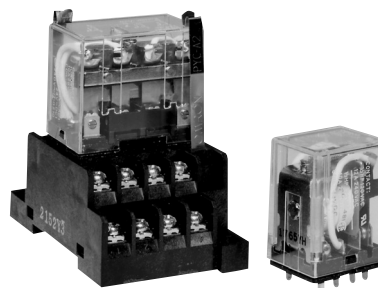

## Ordering Information

To Order: Select the part number and add the desired coil voltage rating (e.g., LY1-DC6).

| Type                                      | Terminal       | Contact form | Model                     |                        |                           |                        |
|---|----------------|--------------|---------------------------|------------------------|---------------------------|------------------------|
|   |                |              | Single contact            |                        | Bifurcated contact        |                        |
|   |                |              | Standard bracket mounting | Upper mounting bracket | Standard bracket mounting | Upper mounting bracket |
| Standard                                  | Plug-in/solder | SPDT         | LY1                       | LY1F                   | —                         | —                      |
|   |                | DPDT         | LY2                       | LY2F                   | LY2Z                      | LY2ZF                  |
|   |                | 3PDT         | LY3                       | LY3F                   | —                         | —                      |
|   |                | 4PDT         | LY4                       | LY4F                   | —                         | —                      |
|   | PCB            | SPDT         | LY1-0                     | —                      | —                         | —                      |
|   |                | DPDT         | LY2-0                     | —                      | LY2Z-0                    | —                      |
|   |                | 3PDT         | LY3-0                     | —                      | —                         | —                      |
|   |                | 4PDT         | LY4-0                     | —                      | —                         | —                      |
| LED indicator                             | Plug-in/solder | SPDT         | LY1N                      | —                      | —                         | —                      |
|   |                | DPDT         | LY2N                      | —                      | LY2ZN                     | —                      |
|   |                | 3PDT         | LY3N                      | —                      | —                         | —                      |
|   |                | 4PDT         | LY4N                      | —                      | —                         | —                      |
| Diode surge suppression                   | Plug-in/solder | SPDT         | LY1-D                     | —                      | —                         | —                      |
|   |                | DPDT         | LY2-D                     | —                      | LY2Z-D                    | —                      |
|   |                | 3PDT         | LY3-D                     | —                      | —                         | —                      |
|   |                | 4PDT         | LY4-D                     | —                      | —                         | —                      |
| LED indicator and diode surge suppression | Plug-in/solder | SPDT         | LY1N-D2                   | —                      | —                         | —                      |
|   |                | DPDT         | LY2N-D2                   | —                      | LY2ZN-D2                  | —                      |
|   |                | 4PDT         | LY4N-D2                   | —                      | —                         | —                      |
| RC circuit                                | Plug-in/solder | SPDT         | LY1-CR                    | —                      | —                         | —                      |
|   |                | DPDT         | LY2-CR                    | —                      | LY2Z-CR                   | —                      |
| LED indicator and RC circuit              | Plug-in/solder | SPDT         | LY1N-CR                   | —                      | —                         | —                      |
|   |                | DPDT         | LY2N-CR                   | —                      | LY2ZN-CR                  | —                      |

- Note:**
1. Types with specifications other than those listed are available. Contact your Omron Sales representative.
  2. To order connecting sockets and mounting tracks, see "Accessories" section.
  3. Relays with RC circuit are only available in AC coil voltages of 100 VAC or greater.

| Type                                  | Terminal       | Contact form | Model                     |                        |                           |                        |
|---------------------------------------|----------------|--------------|---------------------------|------------------------|---------------------------|------------------------|
|                                       |                |              | Single contact            |                        | Bifurcated contact        |                        |
|                                       |                |              | Standard bracket mounting | Upper mounting bracket | Standard bracket mounting | Upper mounting bracket |
| Push-to-test button                   | Plug-in/solder | SPDT         | LY114                     | —                      | —                         | —                      |
|                                       |                | DPDT         | LY214                     | —                      | LY2ZI2                    | —                      |
|                                       |                | 3PDT         | LY314                     | —                      | —                         | —                      |
|                                       |                | 4PDT         | LY414                     | —                      | —                         | —                      |
| LED indicator and push-to-test button | Plug-in/solder | DPDT         | LY214N                    | —                      | LY2ZI2N                   | —                      |
|                                       |                | 4PDT         | LY414N                    | —                      | —                         | —                      |

**Note:** 1. Types with specifications other than those listed are available. Contact your Omron Sales representative.  
 2. To order connecting sockets and mounting tracks, see “Accessories” section.

## ■ Accessories

### Connecting Sockets

To Order: Select the appropriate part numbers for sockets, clips, and mounting tracks (if required) from the following charts.

#### Track Mounted Sockets

| Relay        | Socket*  | Relay hold-down clip |            | Mounting track  |
|--------------|----------|----------------------|------------|---|
|              |          | Standard             | RC circuit |   |
| SPDT<br>DPDT | PTF08A-E | PYC-A1               | Y92H-3     | PFP-100N/PFP-50N & PFP-M or PFP-100N2 PFP-S (Option spacer) |
| 3PDT         | PTF11A   |                      |            |   |
| 4PDT         | PTF14A-E |                      |            |   |

\* Track mounted socket can be used as a front connecting socket.

#### Back Connecting Sockets

| Relay        | Solder terminal socket | Wire wrap terminal socket | Relay hold-down clip |              |            |            | Socket Mounting Plate |        |        |        |
|--------------|------------------------|---------------------------|----------------------|--------------|------------|------------|-----------------------|--------|--------|--------|
|              |                        |                           | Standard             | Push-to-test | RC circuit | Mtg. plate | 1                     | 10     | 12     | 18     |
| SPDT<br>DPDT | PT08                   | PT08QN                    | PYC-P                | PYC-P2       | PYC-1      | PYC-S      | PYP-1                 | —      | —      | PYP-18 |
| 3PDT         | PT11                   | PT11QN                    |                      |              |            |            | PTP-1-3               | —      | PTP-12 | —      |
| 4PDT         | PT14                   | PT14QN                    |                      |              |            |            | PTP-1                 | PTP-10 | —      | —      |

**Note:** Types PYP-18, PTP-12 and PTP-10 may be cut to any desired length.

| Relay        | PC terminal socket | Relay hold-down clip |              |            |
|--------------|--------------------|----------------------|--------------|------------|
|              |                    | Standard             | Push-to-test | RC circuit |
| SPDT<br>DPDT | PT08-0             | PYC-P                | PYC-P2       | PYC-1      |
| 3PDT         | PT11-0             |                      |              |            |
| 4PDT         | PT14-0             |                      |              |            |

# Specifications

## ■ Contact Data

| Load                           | Single contact                    |  |                                   |  | Bifurcated contact              |  |
|--------------------------------|-----------------------------------|--|-----------------------------------|--|---------------------------------|--|
|                                | SPDT                              |  | DPDT, 3PDT, 4PDT                  |  | DPDT                            |  |
|                                | Resistive load<br>(p.f. = 1)      | Inductive load<br>(p.f. = 0.4)<br>(L/R = 7 ms) | Resistive load<br>(p.f. = 1)      | Inductive load<br>(p.f. = 0.4)<br>(L/R = 7 ms) | Resistive load<br>(p.f. = 1)    | Inductive load<br>(p.f. = 0.4)<br>(L/R = 7 ms) |
| <b>Rated load</b>              | 15 A at 110 VAC<br>15 A at 24 VDC | 10 A at 110 VAC<br>7 A at 24 VDC               | 10 A at 110 VAC<br>10 A at 24 VDC | 7.5 A at 110 VAC<br>5 A at 24 VDC              | 5 A at 110 VAC<br>5 A at 24 VDC | 4 A at 110 VAC<br>4 A at 24 VDC                |
| <b>Contact material</b>        | Ag-Alloy                          |  |                                   |  |                                 |  |
| <b>Carry current</b>           | 15 A                              |  | 10 A                              |  | 7 A                             |  |
| <b>Max. operating voltage</b>  | 250 VAC<br>125 VDC                |  |                                   |  |                                 |  |
| <b>Max. operating current</b>  | 15 A                              |  | 10 A                              |  | 7 A                             |  |
| <b>Max. switching capacity</b> | 1,700 VA<br>360 W                 | 1,100 VA<br>170 W                              | 1,100 VA<br>240 W                 | 825 VA<br>120 W                                | 550 VA<br>120 W                 | 440 VA<br>100 W                                |
| <b>Min. permissible load</b>   | 100 mA, 5 VDC                     |  |                                   |  | 10 mA, 5 VDC                    |  |

## ■ Coil Data

### 1- and 2-pole Types – AC

| Rated voltage (V) | Rated current (mA) |           | Coil resistance (Ω) | Coil inductance (ref. value) (H) |             | Pick-up voltage | Dropout voltage | Maximum voltage                    | Power consumption (VA, W)          |
|-------------------|--------------------|-----------|---------------------|----------------------------------|-------------|-----------------|-----------------|------------------------------------|------------------------------------|
|                   | 50 Hz              | 60 Hz     |                     | Armature OFF                     | Armature ON |                 |                 |                                    |                                    |
| 6                 | 214.10             | 183       | 12.20               | 0.04                             | 0.08        | 80% max.        | 30% min.        | 110%                               | Approx.<br>1.00 to 1.20<br>(60 Hz) |
| 12                | 106.50             | 91        | 46                  | 0.17                             | 0.33        |                 |                 |                                    |                                    |
| 24                | 53.80              | 46        | 180                 | 0.69                             | 1.30        |                 |                 |                                    |                                    |
| 50                | 25.70              | 22        | 788                 | 3.22                             | 5.66        |                 |                 |                                    |                                    |
| 100/110           | 11.70/12.90        | 10/11     | 3,750               | 14.54                            | 24.60       |                 |                 |                                    |                                    |
| 110/120           | 9.90/10.80         | 8.40/9.20 | 4,430               | 19.20                            | 32.10       |                 |                 |                                    |                                    |
| 200/220           | 6.20/6.80          | 5.30/5.80 | 12,950              | 54.75                            | 94.07       |                 |                 |                                    |                                    |
| 220/240           | 4.80/5.30          | 4.20/4.60 | 18,790              | 83.50                            | 136.40      |                 |                 | Approx.<br>0.90 to 1.10<br>(60 Hz) |                                    |

### 1- and 2-pole Types – DC

| Rated voltage (V) | Rated current (mA) | Coil resistance (Ω) | Coil inductance (ref. value) (H) |             | Pick-up voltage | Dropout voltage | Maximum voltage | Power consumption (VA, W) |
|-------------------|--------------------|---------------------|----------------------------------|-------------|-----------------|-----------------|-----------------|---------------------------|
|                   |                    |                     | Armature OFF                     | Armature ON |                 |                 |                 |                           |
| 6                 | 150                | 40                  | 0.16                             | 0.33        | 80% max.        | 10% min.        | 110%            | Approx.<br>0.90           |
| 12                | 75                 | 160                 | 0.73                             | 1.37        |                 |                 |                 |                           |
| 24                | 36.90              | 650                 | 3.20                             | 5.72        |                 |                 |                 |                           |
| 48                | 18.50              | 2,600               | 10.60                            | 21          |                 |                 |                 |                           |
| 100/110           | 9.10/10            | 11,000              | 45.60                            | 86.20       |                 |                 |                 |                           |

- Note:**
1. The rated current and coil resistance are measured at a coil temperature of 23°C (73°F) with tolerances of +15%, -20% for AC rated current, and ±15% for DC rated coil resistance.
  2. The AC coil resistance and inductance are reference values at 60 Hz.
  3. The performance characteristics are measured at a coil temperature of 23°C (73°F).
  4. Class B coil insulation is available.

### 3-pole Type – AC

| Rated voltage (V) | Rated current (mA) |             | Coil resistance (Ω) | Coil inductance (ref. value) (H) |             | Pick-up voltage | Dropout voltage | Maximum voltage | Power consumption (VA, W)    |
|-------------------|--------------------|-------------|---------------------|----------------------------------|-------------|-----------------|-----------------|-----------------|------------------------------|
|                   | 50 Hz              | 60 Hz       |                     | Armature OFF                     | Armature ON |                 |                 |                 |                              |
| 6                 | 310                | 270         | 6.70                | 0.03                             | 0.05        | 80% max.        | 30% min.        | 110%            | Approx. 1.60 to 2.00 (60 Hz) |
| 12                | 159                | 134         | 24                  | 0.12                             | 0.21        |                 |                 |                 |                              |
| 24                | 80                 | 67          | 100                 | 0.44                             | 0.79        |                 |                 |                 |                              |
| 50                | 38                 | 33          | 410                 | 2.24                             | 3.87        |                 |                 |                 |                              |
| 100/110           | 15.90/18.30        | 13.60/15.60 | 2,300               | 10.50                            | 18.50       |                 |                 |                 |                              |
| 120               | 17.30              | 14.8        | 2,450               | 11.50                            | 20.60       |                 |                 |                 |                              |
| 200/220           | 10.50/11.60        | 9.00/9.90   | 8,650               | 34.80                            | 59.50       |                 |                 |                 |                              |
| 240               | 9.40               | 8           | 10,400              | 38.60                            | 74.60       |                 |                 |                 |                              |

### 3-pole Type – DC

| Rated voltage (V) | Rated current (mA) |  | Coil resistance (Ω) | Coil inductance (ref. value) (H) |             | Pick-up voltage | Dropout voltage | Maximum voltage | Power consumption (VA, W) |
|-------------------|--------------------|--|---------------------|----------------------------------|-------------|-----------------|-----------------|-----------------|---------------------------|
|                   |                    |  |                     | Armature OFF                     | Armature ON |                 |                 |                 |                           |
| 6                 | 234                |  | 25.70               | 0.11                             | 0.21        | 80% max.        | 10% min.        | 110%            | Approx. 1.40              |
| 12                | 112                |  | 107                 | 0.45                             | 0.98        |                 |                 |                 |                           |
| 24                | 58.60              |  | 410                 | 1.89                             | 3.87        |                 |                 |                 |                           |
| 48                | 28.20              |  | 1,700               | 8.53                             | 13.90       |                 |                 |                 |                           |
| 100/110           | 12.70/13           |  | 8,500               | 29.60                            | 54.30       |                 |                 |                 |                           |

### 4-pole Type – AC

| Rated voltage (V) | Rated current (mA) |            | Coil resistance (Ω) | Coil inductance (ref. value) (H) |             | Pick-up voltage | Dropout voltage | Maximum voltage | Power consumption (VA, W)    |
|-------------------|--------------------|------------|---------------------|----------------------------------|-------------|-----------------|-----------------|-----------------|------------------------------|
|                   | 50 Hz              | 60 Hz      |                     | Armature OFF                     | Armature ON |                 |                 |                 |                              |
| 6                 | 386                | 330        | 5                   | 0.02                             | 0.04        | 80% max.        | 30% min.        | 110%            | Approx. 1.95 to 2.50 (60 Hz) |
| 12                | 199                | 170        | 20                  | 0.10                             | 0.17        |                 |                 |                 |                              |
| 24                | 93.60              | 80         | 78                  | 0.38                             | 0.67        |                 |                 |                 |                              |
| 50                | 46.80              | 40         | 350                 | 1.74                             | 2.88        |                 |                 |                 |                              |
| 100/110           | 22.50/25.50        | 19/21.80   | 1,800               | 10.50                            | 17.30       |                 |                 |                 |                              |
| 120               | 19.00              | 16.40      | 2,200               | 9.30                             | 19          |                 |                 |                 |                              |
| 200/220           | 11.50/13.10        | 9.80/11.20 | 6,700               | 33.10                            | 57.90       |                 |                 |                 |                              |
| 240               | 11.00              | 9.50       | 9,000               | 33.20                            | 63.40       |                 |                 |                 |                              |

### 4-pole Type – DC

| Rated voltage (V) | Rated current (mA) |  | Coil resistance (Ω) | Coil inductance (ref. value) (H) |             | Pick-up voltage | Dropout voltage | Maximum voltage | Power consumption (VA, W) |
|-------------------|--------------------|--|---------------------|----------------------------------|-------------|-----------------|-----------------|-----------------|---------------------------|
|                   |                    |  |                     | Armature OFF                     | Armature ON |                 |                 |                 |                           |
| 6                 | 240                |  | 25                  | 0.09                             | 0.21        | 80% max.        | 10% min.        | 110%            | Approx. 1.50              |
| 12                | 120                |  | 100                 | 0.39                             | 0.84        |                 |                 |                 |                           |
| 24                | 69                 |  | 350                 | 1.41                             | 2.91        |                 |                 |                 |                           |
| 48                | 30                 |  | 1,600               | 6.39                             | 13.60       |                 |                 |                 |                           |
| 100/110           | 15/15.90           |  | 6,900               | 32                               | 63.70       |                 |                 |                 |                           |

- Note:**
1. The rated current and coil resistance are measured at a coil temperature of 23°C (73°F) with tolerances of +15%, -20% for AC rated current, and ±15% for DC rated coil resistance.
  2. The AC coil resistance and inductance are reference values at 60 Hz.
  3. The performance characteristics are measured at a coil temperature of 23°C (73°F).
  4. Class B coil insulation is available.

## ■ Characteristics

|                              |                               |   |
|------------------------------|-------------------------------|---|
| <b>Contact resistance</b>    |                               | 50 mΩ max.  |
| <b>Operate time</b>          |                               | 25 ms max.  |
| <b>Release time</b>          |                               | 25 ms max.  |
| <b>Operating frequency</b>   | <b>Mechanically</b>           | 18,000 operations/hour  |
|                              | <b>Under rated load</b>       | 1,800 operations/hour   |
| <b>Insulation resistance</b> |                               | 100 MΩ min. (at 500 VDC)  |
| <b>Dielectric strength</b>   |                               | 2,000 VAC, 50/60 Hz for 1 minute<br>1,000 VAC, 50/60 Hz for 1 minute between contacts of same polarity  |
| <b>Vibration</b>             | <b>Mechanical durability</b>  | 10 to 55 Hz, 1.00 mm (0.04 in) double amplitude   |
|                              | <b>Malfunction durability</b> | 10 to 55 Hz, 1.00 mm (0.04 in) double amplitude   |
| <b>Shock</b>                 | <b>Mechanical durability</b>  | 1,000 m/s <sup>2</sup> (approx. 100 G)  |
|                              | <b>Malfunction durability</b> | 200 m/s <sup>2</sup> (approx. 20 G)   |
| <b>Ambient temperature</b>   | <b>Operating</b>              | LY1, LY2, LY3: -25° to 55°C; LY4 = -25° to 40°C   |
| <b>Humidity</b>              |                               | 35 to 85% RH  |
| <b>Service Life</b>          | <b>Mechanically</b>           | AC: 50 million operations min. (at operating frequency of 18,000 operations/hour)<br>DC: 100 million operations min. (at operating frequency of 18,000 operations/hour) |
|                              | <b>Electrically</b>           | See "Characteristic Data"   |
| <b>Weight</b>                |                               | SPDT, DPDT: Approx. 40 g (1.41 oz), 3PDT: Approx. 50 g (1.76 oz)<br>4PDT: Approx. 70 g (2.47 oz)  |

Note: Data shown are of initial value.

## ■ Characteristic Data

### Maximum switching capacity

LY1

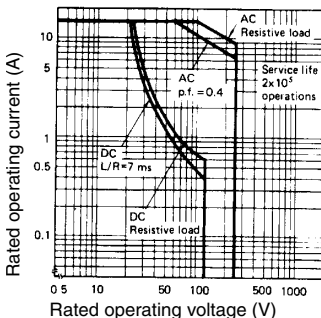

LY2

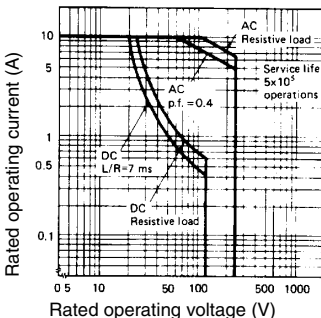

LY3, LY4

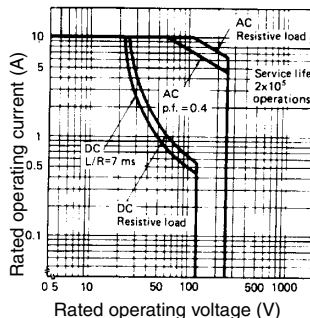

LY2Z

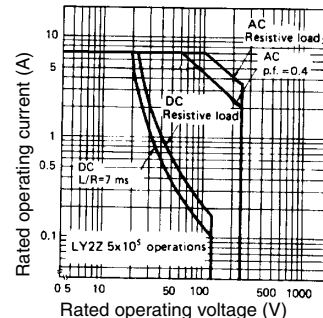

### Electrical service life

LY1

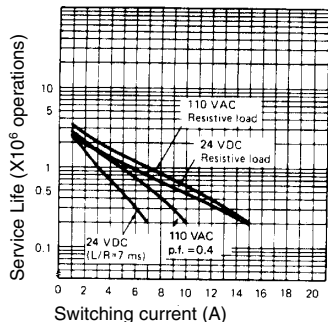

LY2

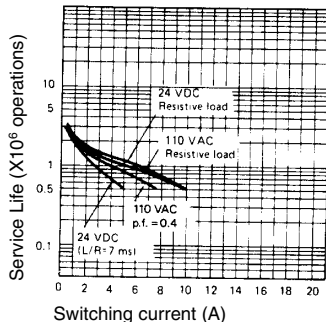

LY3, LY4

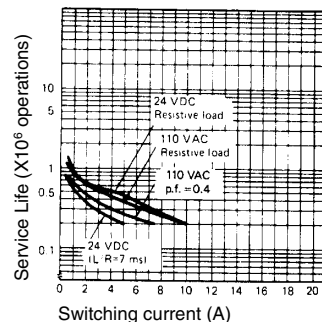

LY2Z

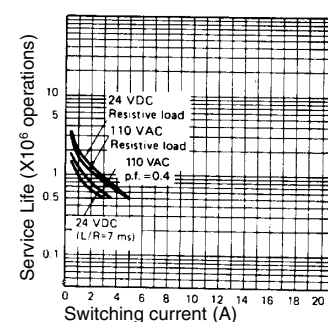

# Dimensions

Unit: mm (inch)

## Relays

LY1

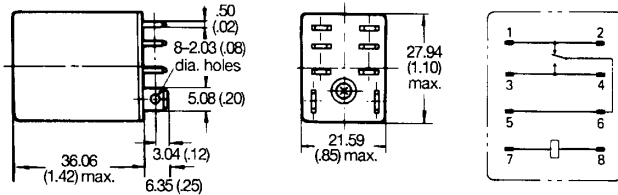

LY2

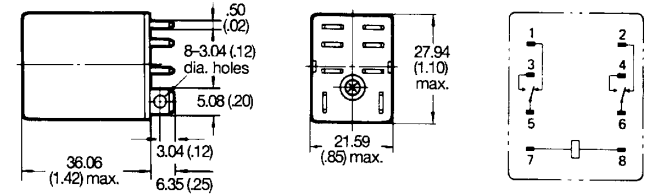

LY3

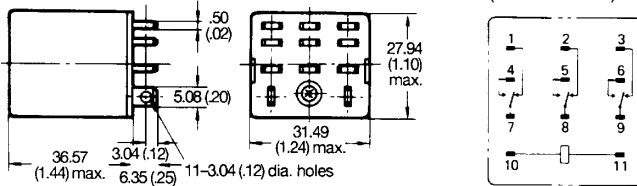

LY4

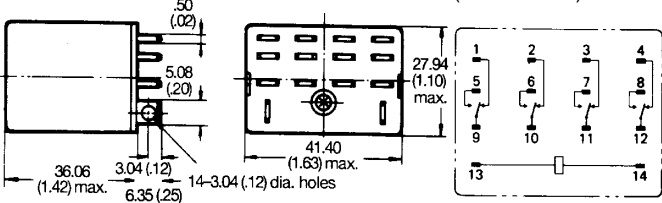

LY1-0, LY2-0, LY3-0, LY4-0

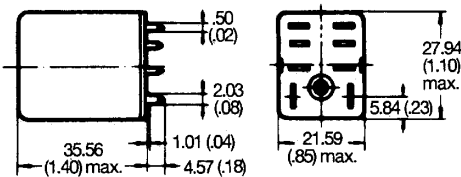

Mounting holes for LY1-0, LY2-0, LY3-0, LY4-0 (Bottom view)

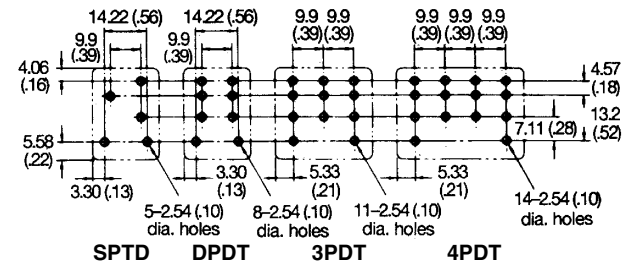

Note: The above drawing shows LY2-0. With LY1-0, dimension "\*" should read as eight 6.35 (.25).

LY1F, LY2F

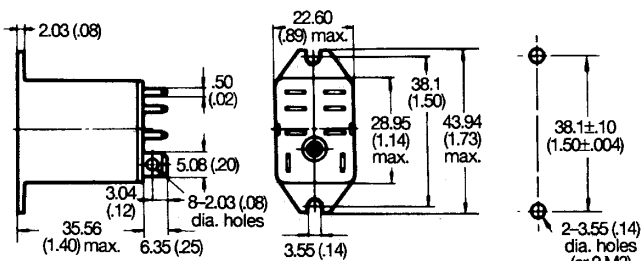

LY3F

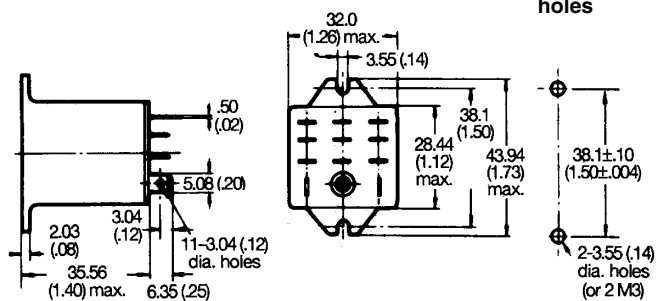

Note: The above drawing shows LY1F. With LY2F, dimension "\*" should read as eight 3.05 mm (0.12 in) dia. holes.

LY4F

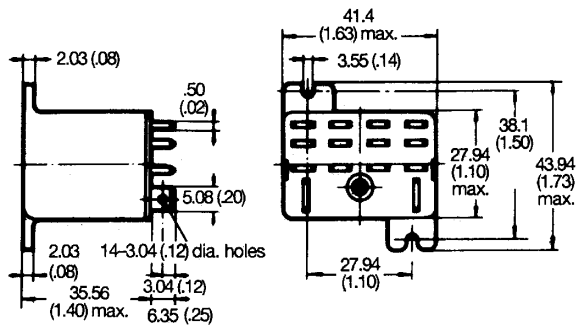

Mounting holes

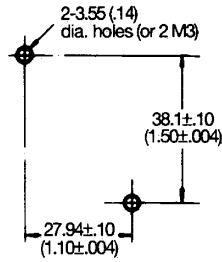

LY1S, LY2S

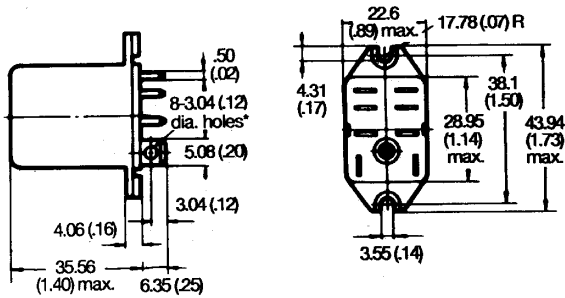

Round hole

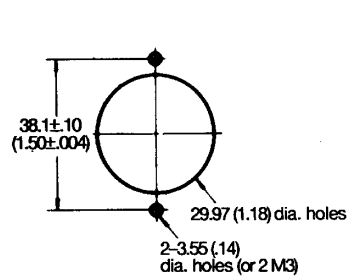

Rectangular hole

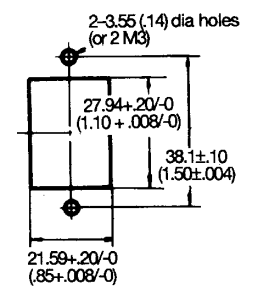

Note: The above drawing shows LY2S-US. With LY1S-US, dimension "\*\*\*\*" should read as eight 2.03 mm (0.08 in) dia. holes.

LY3S

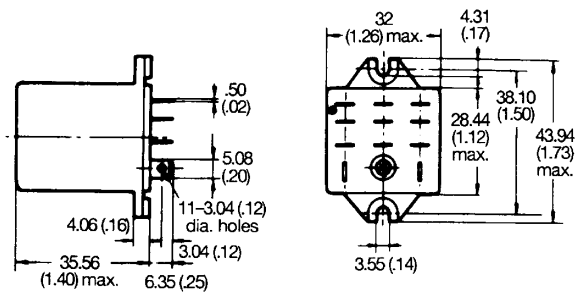

Round hole

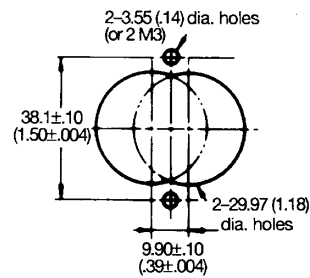

Rectangular hole

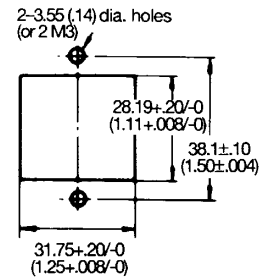

LY4S

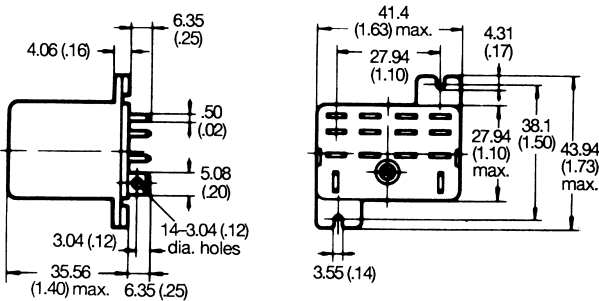

Round hole

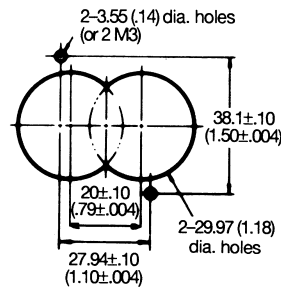

Rectangular hole

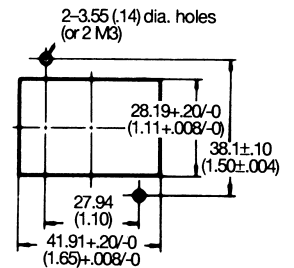

## ■ Accessories

Unit: mm (inch)

### Track mounted sockets (UL File No. E87929) (CSA Report No. LR31928)

**PTF08A**  
(see note 3)

**Terminal arrangement/  
mounting holes**  
(Top view)

**PTF11A**

**Terminal arrangement/  
mounting holes**  
(Top view)

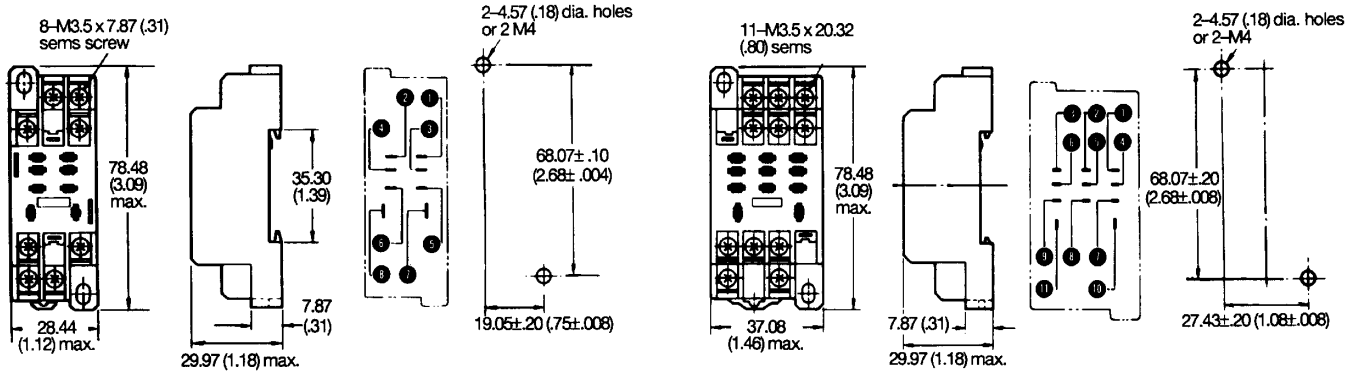

### Track mounting sockets (UL File No. E87929) (CSA Report No. LR31928)

**PTF14A**  
(see note 3)

**Terminal arrangement/  
mounting holes**  
(Top view)

**Mounting height of  
relay with socket**  
(Applies to all PTF□A sockets)

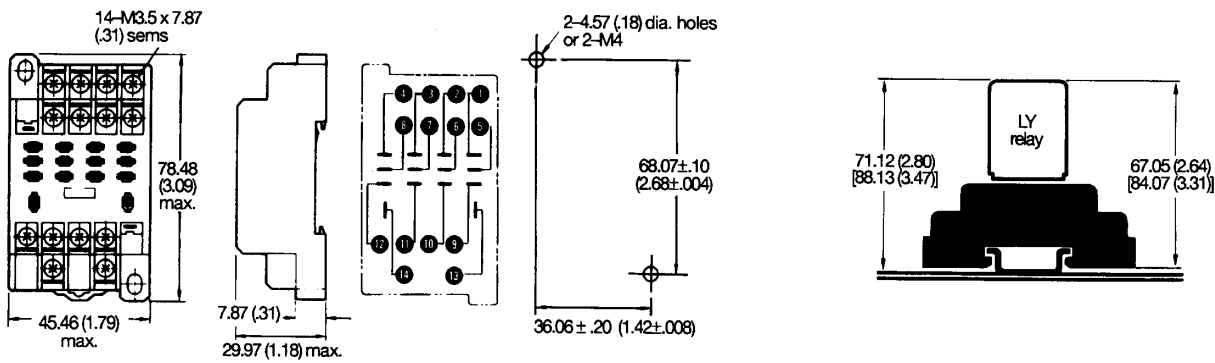

- Note:**
1. UL/CSA does not apply to wire wrap (Q) type sockets.
  2. Values in brackets for LY□CR.
  3. PTF08A-E and PTF14A-E = touch safe screws. Height = 33 mm max.

### Back connecting socket (UL File No. E87929) (CSA Report No. LR31928)

**PT08**

**Terminal arrangement/  
(Bottom view)**

**PT11**

**Terminal arrangement/  
(Bottom view)**

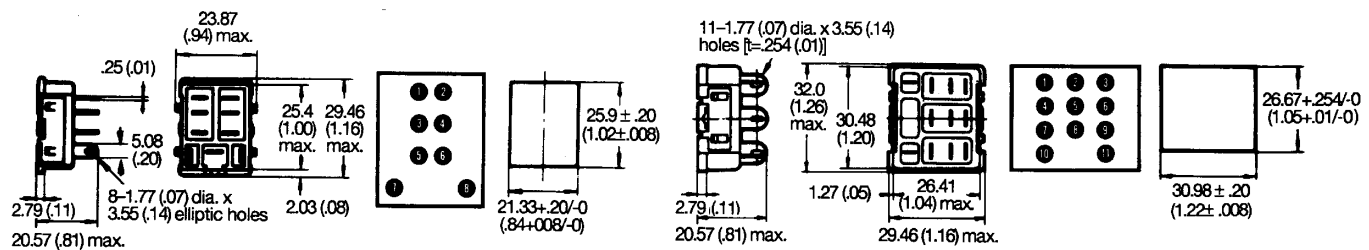



Back connecting socket (UL File No. E87929) (CSA Report No. LR31928)

PT14

Terminal arrangement  
(Bottom view)

Mounting height of relay with socket  
(Applies to all PT sockets)

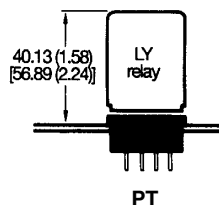
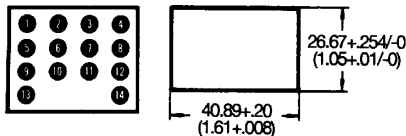
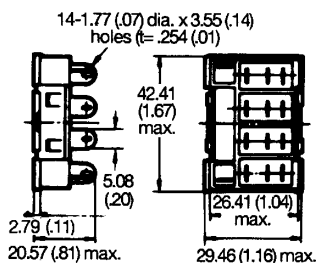

Note: Values in brackets for LY□CR.

Back connecting socket (UL File No. E87929) (CSA Report No. LR31928)

PT08QN

Panel cut-out and terminal arrangement are the same as Type PT08.

PT11QN

Panel cut-out and terminal arrangement are the same as Type PT11.

PT14QN

Panel cut-out and terminal arrangement are the same as Type PT14.

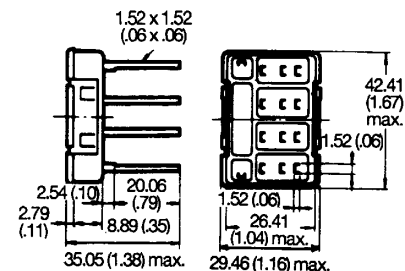
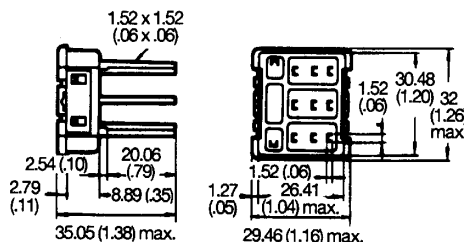
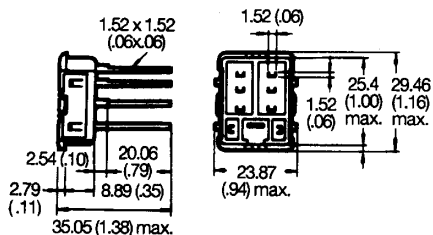

Back connecting socket (UL File No. E87929) (CSA Report No. LR31928)

PT08-0

Terminal arrangement is the same as Type PT08.

Mounting holes  
(Bottom view)

PT11-0

Terminal arrangement is the same as Type PT11.

Mounting holes  
(Bottom view)

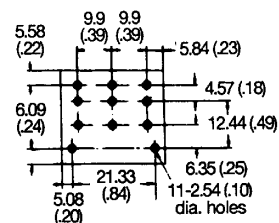
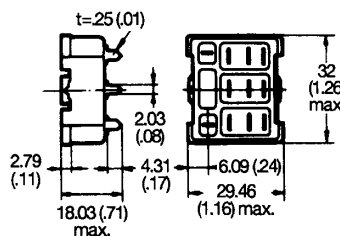
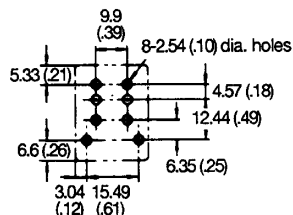
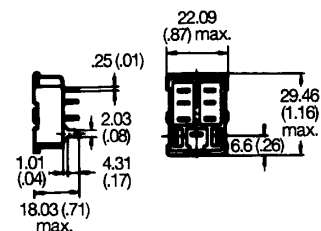

Back connecting socket (UL File No. E87929) (CSA Report No. LR31928)

PT14-0

Terminal arrangement is the same as Type PT14.

Mounting holes  
(Bottom view)

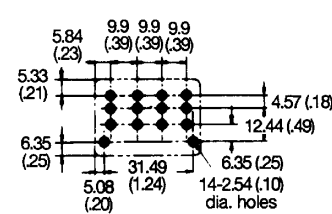
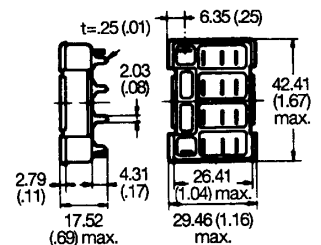

Unit: mm (inch)

**Relay hold-down clips**

**PYC-A1**

For PTF□A socket

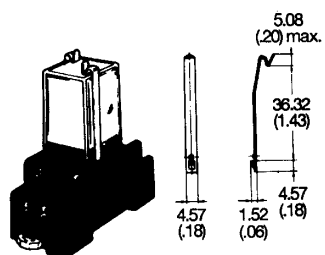

**PYC-S**

For relay mounting plates  
(Applicable to Type PYP-1 and PYP-18 socket mounting plates only.)

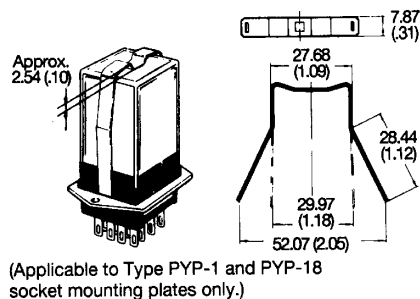

**PYC-P**

For PT□ socket

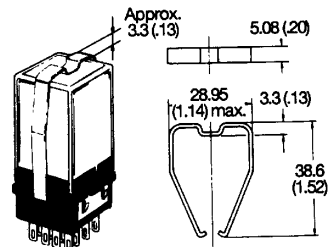

**Relay hold-down clips**

**PYC-P2**

For push-to-test button type with PT□ socket

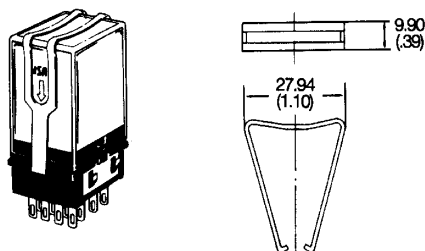

**Y92H-3**

For RC circuit type

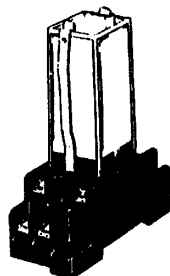

**PYC-1**

For RC circuit type



**Mounting track/end plate/spacer**

**PFP-100N, PFP-50N**  
(Conforming to EN 50022)

**PFP-100N2**  
(Conforming to EN 50022)

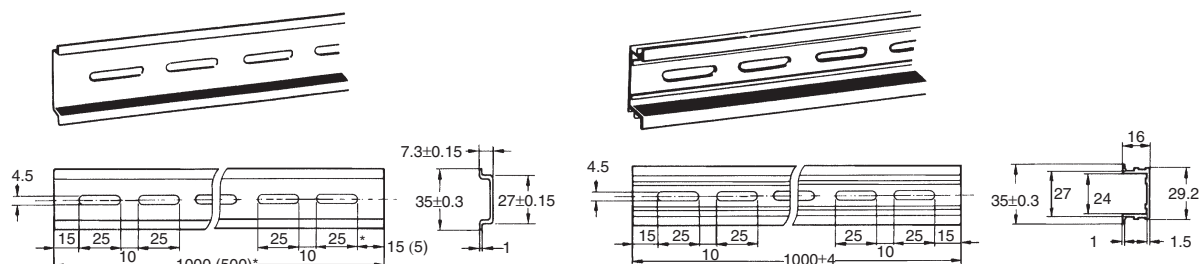

\* The figure in parenthesis is for PFP-50N.

\*This dimension is 14.99 mm (0.59 in) on both ends in the case of PFP-100N, but on one end in the case of PFP-50N.

\*\* L = Length

PFP-50N L = 497.84 mm (19.60 in)

PFP-100N L = 990.60 mm (39.00 in)

PFP-100N2 L = 990.60 mm (39.00 in)

\*\*\*A total of twelve 24.89 x 4.57 mm (0.98 x 0.18 in) elliptic holes are provided, with six holes cut from each end of the track at a pitch of 9.91 (0.39) between holes.

PFP-M end plate

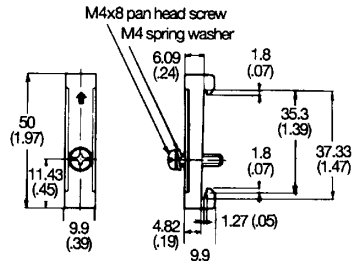

PFP-S spacer

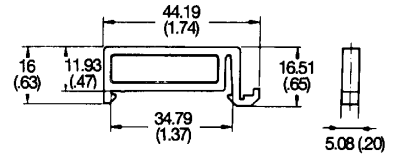

Socket mounting plates [t=1.52 (.06)]

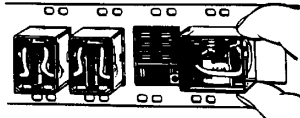

| Socket needed | Number of socket specs. |        |         |        |
|---------------|-------------------------|--------|---------|--------|
|               | 1                       | 10     | 12      | 18     |
| PT08, PT08QN  | PYP-1                   | -      | -       | PYP-18 |
| PT11, PT11QN  | PTP-1-3                 | -      | PTP-1-2 | -      |
| PT14, PT14QN  | PTP-1                   | PTP-10 | -       | -      |
| PTP-10        | PTP-12                  |        |         |        |

PYP-1

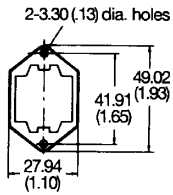

PTP-1-3

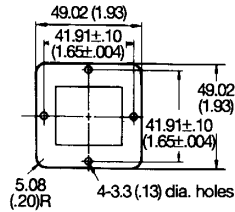

PTP-1

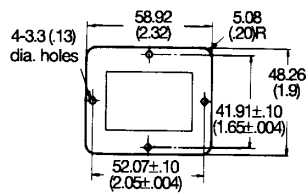

PYP-18

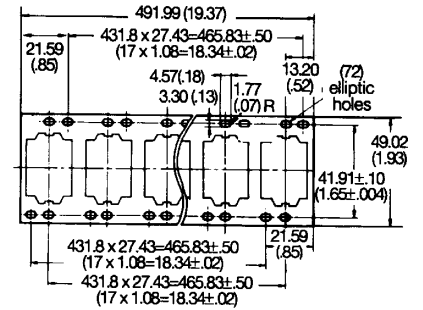

PTP-10

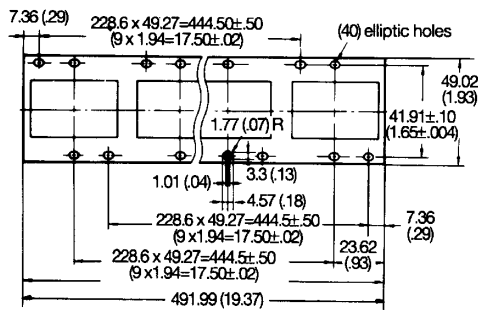

PTP-12

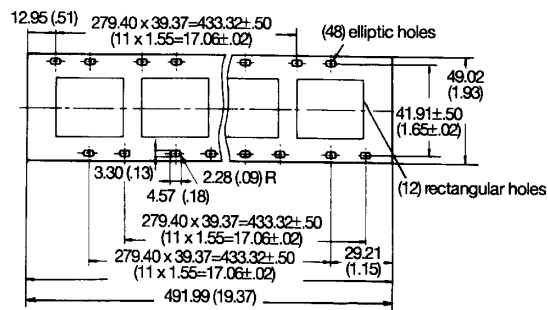

## ■ Relay Options

### LED Indicator

Specifications and dimensions same as the Standard Type with the following exception. With the LED indicator type, the rated current is approximately 0 to 5.0 mA higher than the Standard Type.

#### Terminal arrangement/Internal connections (Bottom view)

##### LY2N

##### DC coil rating type

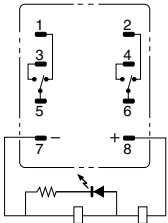

##### AC coil rating type

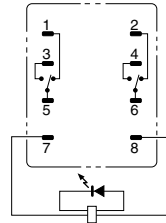

- Note:**
1. The coil terminals 10 and 11 of Type LY3N become (-) and (+) and terminals 13 and 14 of Type LY4N become (-) and (+), respectively.
  2. Pay special attention to the polarities when using the DC type.

### Diode Surge Suppression

Specifications and dimensions same as the Standard Type with the following exception. Ambient operating temperature: -25° to 40°C (-13° to 104°F)

#### Without Diode

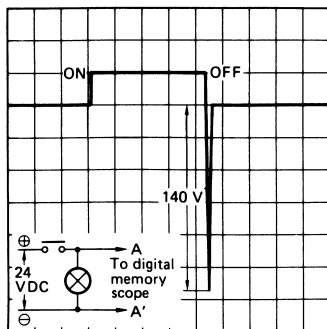

#### With Diode

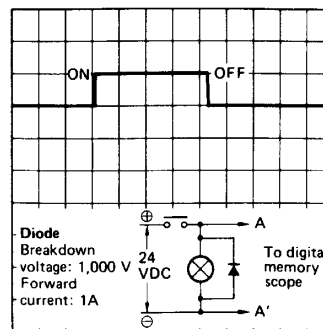

#### Terminal arrangement/Internal connections (Bottom view)

##### LY2(N)-D(2)

LY2-D  
6, 12, 24, 48  
100/110 VDC

LY2N-D2  
6, 12, 24, 48 VDC

LY2N-D2  
100/110 VDC

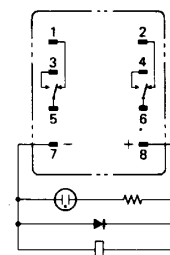
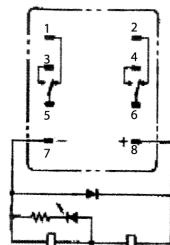
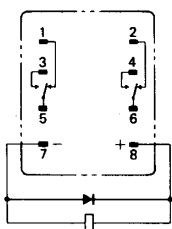

- Note:**
1. Pay special attention to the polarities when using the DC type.
  2. The release time is somewhat longer, but satisfies the standard specifications of 25 ms.
  3. The reverse-breakdown voltage of the diode is 1,000 VDC.
  4. Available on DC versions only.

## Relay Options

### RC Circuit

Specifications and dimensions same as the Standard Type with the following exceptions.

#### Characteristic Data

##### Without RC circuit

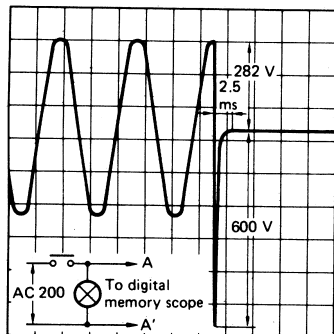

##### With RC circuit

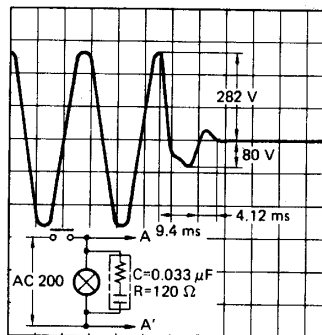

#### LY1-CR, LY2(Z)-CR

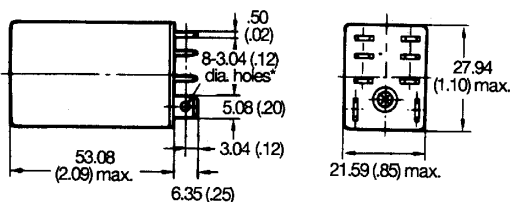

#### Terminal arrangement/Internal connections (Bottom view)

##### LY1-CR

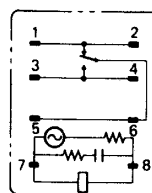

##### LY2(Z)-CR

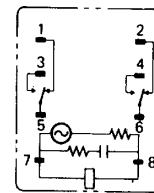

RC circuit  
C: 0.033 μF  
R: 120 Ω

- Note:**
- The above drawing shows LY2(Z)-CR. With LY1-CR, “\*” should read eight 2.03 mm (0.08 in) dia. holes.
  - Available on AC versions only.

#### Push-to-test Button

Specifications and dimensions same as the Standard Type with the following exceptions.

##### LY□12

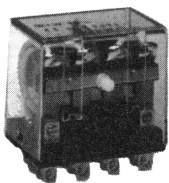

##### LY112, LY212

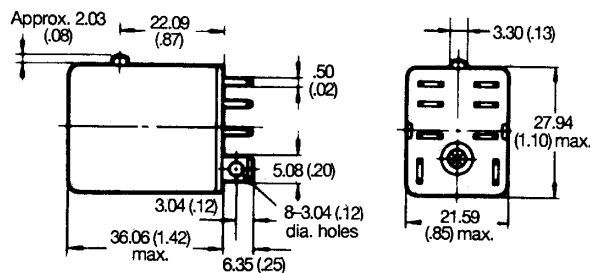

- Note:** Type LY112 has the same dimensions and appearances as Type LY212 shown except that dimensions “\*” is 2.03 mm (0.08 in) dia. holes.

##### LY312

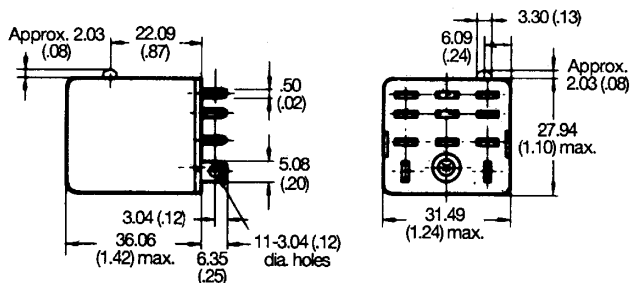

##### LY412

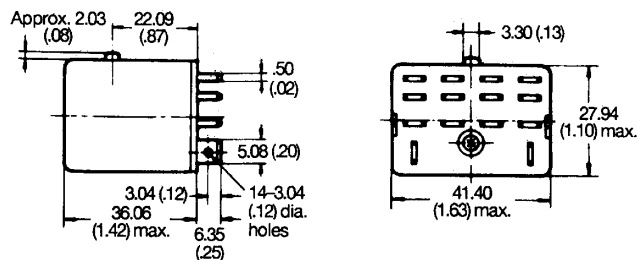

## ■ Approvals

### UL Recognized Type (File No. E41643)

| Type                  | Contact form       | Coil ratings                 | Contact ratings                                  | Number of test operations |
|-----------------------|--------------------|------------------------------|--|---------------------------|
| LY1□                  | SPDT               | 6 to 240 VAC<br>6 to 120 VDC | 15A, 30VDC (Resistive), 40°C                     | 6 x 10 <sup>3</sup>       |
|                       |                    |                              | 15A, 240VAC (General use), 40°C                  |                           |
|                       |                    |                              | TV-5, 120VAC, 40°C                               | 25 x 10 <sup>3</sup>      |
|                       |                    |                              | 1/2HP, 120VAC, 50°C                              |                           |
| LY2□                  | DPDT               |                              | 15A, 28VDC (Resistive), 40°C                     | 6 x 10 <sup>3</sup>       |
|                       |                    |                              | 15A, 120VAC (Resistive), 40°C                    |                           |
|                       |                    |                              | 12A, 240VAC (General use), 40°C                  | 25 x 10 <sup>3</sup>      |
|                       |                    |                              | 1/2HP, 120VAC, 50°C                              |                           |
|                       | TV-3, 120VAC, 40°C |                              |  |                           |
| LY3□                  | 3PDT               |                              | 10A, 30VDC (Resistive), 40°C (Same polarity )    | 6 x 10 <sup>3</sup>       |
| LY4□                  | 4PDT               |                              | 10A, 240VAC (General use), 40°C (Same polarity ) |                           |
|                       |                    |                              | 1/2HP, 240VAC, 40°C                              |                           |
| LY2Z□<br>(Bifurcated) | DPDT               |                              | 7A, 240VAC (General use), 40°C                   | 6 x 10 <sup>3</sup>       |
|                       |                    |                              | 7A, 28VDC (Resistive), 40°C                      |                           |

### CSA Certified Type (File No. LR31928)

| Type | Contact form | Coil ratings                 | Contact ratings           |
|------|--------------|------------------------------|---------------------------|
| LY1□ | SPDT         | 6 to 240 VAC<br>6 to 120 VDC | 15 A, 120 VAC (Inductive) |
|      |              |                              | 10 A, 240 VAC (Inductive) |
|      |              |                              | 15 A, 28 VDC (Resistive)  |
|      |              |                              | TV-5 (ACTV)               |
| LY2□ | DPDT         |                              | 13 A, 28 VDC (Resistive)  |
|      |              |                              | 12 A, 120 VAC (Inductive) |
|      |              |                              | 10 A, 240 VAC (Inductive) |
|      |              |                              | 1/3 HP, 120 VAC (Motor)   |
|      |              |                              | TV-3 (ACTV)               |
|      |              |                              |                           |
| LY3□ | 3PDT         |                              | 10 A, 240 VAC (Inductive) |
| LY3□ | 4PDT         |                              | 10 A, 28 VDC (Resistive)  |

### VDE Approved Type (File No. 9903 [SPDT, DPDT & 3PDT], File No. 9947 [4PDT])

| Type   | Contact form | Coil ratings  | Contact ratings                         |
|--------|--------------|---|---|
| LY□-VD | SPDT         | 6, 12, 24, 50,<br>110, 220 VAC<br>and 6, 12, 24,<br>48, 110 VDC | 10 A, 220 VAC (Resistive)               |
|        |              |   | 10 A, 28 VDC (Resistive)                |
|        |              |   | 7 A, 220 VAC (Inductive)                |
|        |              |   | 7 A, 28 VDC (Inductive)                 |
| LY□-VD | DPDT         |   | 7 A, 220 VAC (Resistive)                |
|        | 3PDT         |   | 7 A, 28 VDC (Resistive)                 |
|        | 4PDT         |   | 4 A, 28 VDC and 4A, 220 VAC (Inductive) |

### LR (Lloyd's Register) Approved Type (File No. 562KOB-204523)

| Type | Contact form | Coil ratings | Contact ratings            |
|------|--------------|--------------|----------------------------|
| LY□  | DPDT         | 6 to 240 VAC | 7.5 A, 230 VAC (Inductive) |
|      | 4PDT         | 6 to 110 VDC | 5 A, 24 VDC (Inductive)    |

### SEV Listed Type (File No. D7 91/82 [2- & 4-pole], D 91/204a [1- & 3-pole])

| Type   | Contact form | Coil ratings                 | Contact ratings           |
|--------|--------------|------------------------------|---------------------------|
| LY□-SV | SPDT         | 6 to 240 VAC<br>6 to 110 VDC | 15 A, 220 VAC (Resistive) |
|        |              |                              | 15 A, 24 VDC (Resistive)  |
| LY□-SV | DPDT         |                              | 10 A, 220 VAC (Resistive) |
|        | 3PDT         |                              | 10 A, 24 VDC (Resistive)  |
|        | 4PDT         |                              |                           |

- Note:** 1. The rated values approved by each of the safety standards (e.g., UL, CSA, VDE, and SEV) may be different from the performance characteristics individually defined in this catalog.  
2. In the interest of product improvement, specifications are subject to change.

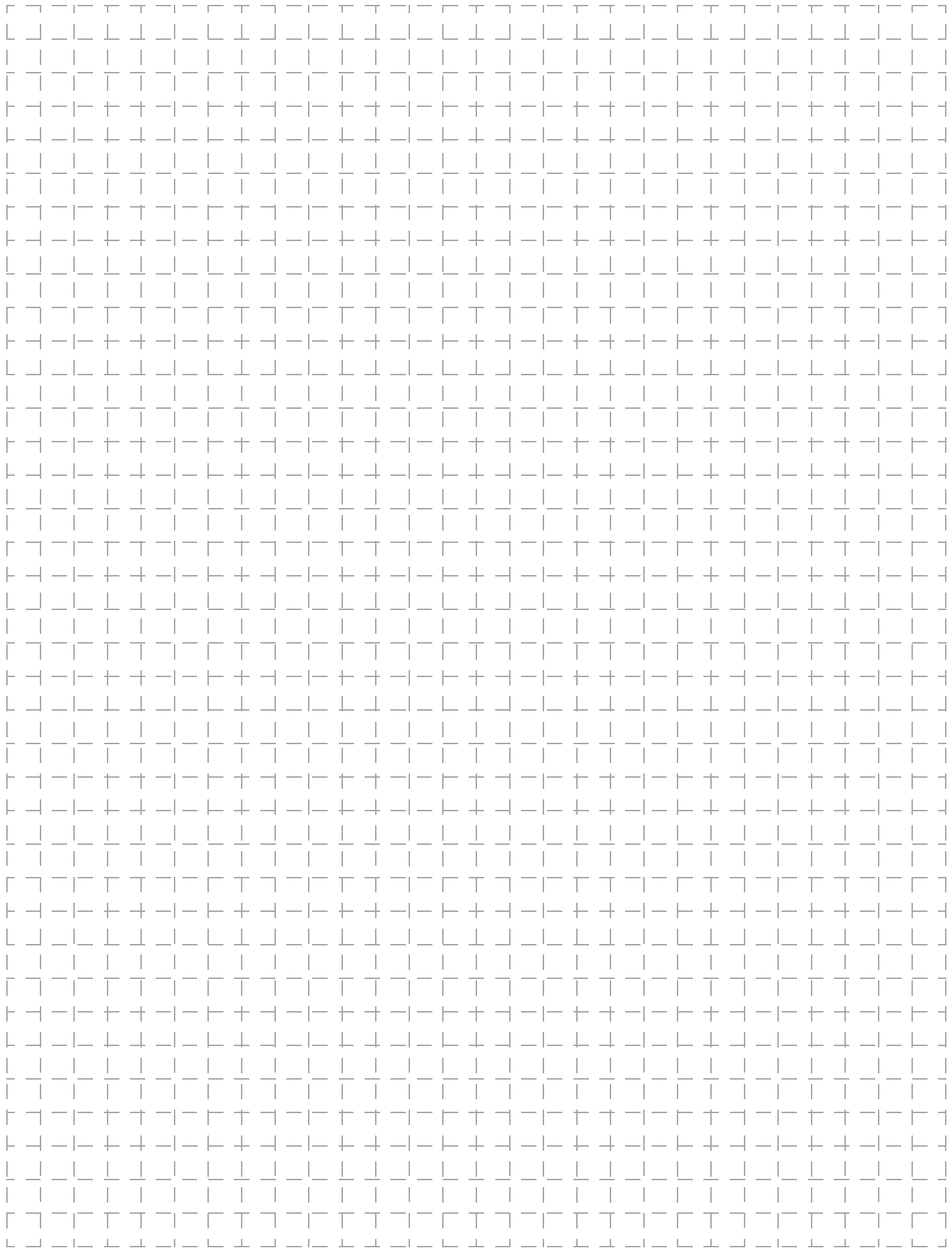

All sales are subject to Omron Electronic Components LLC standard terms and conditions of sale, which can be found at [http://www.components.omron.com/components/web/webfiles.nsf/sales\\_terms.html](http://www.components.omron.com/components/web/webfiles.nsf/sales_terms.html)

**ALL DIMENSIONS SHOWN ARE IN MILLIMETERS.**

To convert millimeters into inches, multiply by 0.03937. To convert grams into ounces, multiply by 0.03527.

---

**OMRON**<sup>®</sup>

**OMRON ELECTRONIC  
COMPONENTS LLC**

55 E. Commerce Drive, Suite B  
Schaumburg, IL 60173

**847-882-2288**

**OMRON ON-LINE**

Global - <http://www.omron.com>

USA - <http://www.components.omron.com>

Cat. No. X301-E-1b

09/11

Specifications subject to change without notice

Printed in USA



## X-ON Electronics

Largest Supplier of Electrical and Electronic Components

*Click to view similar products for [General Purpose Relays](#) category:*

*Click to view products by [Omron](#) manufacturer:*

Other Similar products are found below :

[PCN-105D3MH,000](#) [59641F200](#) [LY1SAC110120](#) [5X827E](#) [5X837F](#) [5X840F](#) [5X842F](#) [5X848E](#) [LY2N-AC120](#) [LY2S-AC220/240](#) [LY2-US-AC120](#) [LY3-US-AC120](#) [LY4F-UA-DC12](#) [LY4F-UA-DC24](#) [LY4F-US-AC120](#) [LY4F-US-AC240](#) [LY4F-US-DC24](#) [LY4F-VD-AC110](#) [LYQ20DC12](#) [M115C60](#) [M115N010](#) [M115N0150](#) [6031007G](#) [603-12D](#) [61211T0B4](#) [61212T400](#) [61222Q400](#) [61243B600](#) [61243C500](#) [61243Q400](#) [61311BOA2](#) [61311BOA6](#) [61311BOA8](#) [61311C0A2](#) [61311COA1](#) [61311COA6](#) [61311F0A2](#) [61311QOA1](#) [61311QOA4](#) [61311T0D6](#) [61311TOA6](#) [61311TOA7](#) [61311TOB3](#) [61311TOB4](#) [61311U0A6](#) [61312Q600](#) [61312T400](#) [61312T600](#) [61313U200](#) [61313U400](#)