

New Latching Levers for Circuit Checking Added to Our Best-selling MY General-purpose Relays

- Now lead-free to protect the environment.
- VDE certification (Germany).
- Different colors of coil tape for AC and DC models to more easily distinguish them.
- MY(S) models with latching levers added for easier circuit checking.

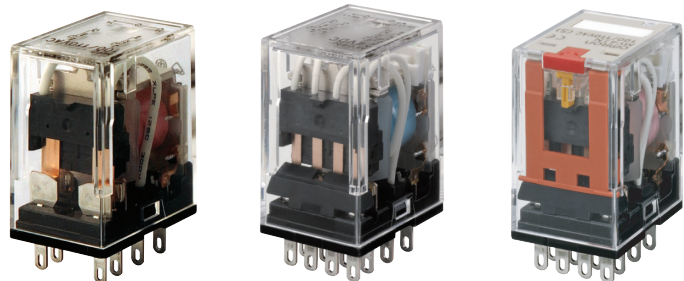

 Refer to the *Common Relay Precautions*.

Model Number Structure

Classification	Structure	Relays with Plug-in Terminals			PCB terminals	Case-surface mounting
		With operation indicator	Without operation indicator	With latching lever		
Standard models (compliant with Electrical Appliances and Material Safety Act)	2	MY2N*	MY2*	MY2IN(S)*	MY2-02	MY2F
		MY2ZN	MY2Z			
	3	MY3N	MY3		MY3-02	MY3F
		MY4N*	MY4*	MY4IN(S)*		
4	Bifurcated	MY4ZN*	MY4Z*	MY4ZIN(S)*	MY4-02	MY4F
					MY4Z-02	MY4ZF
Models with diode for coil surge absorption (DC coil specification only)	2	MY2N-D2*	MY2-D*	MY2IN-D2(S)*	---	---
		MY2ZN-D2	MY2Z-D			
	3	MY3N-D2	MY3-D		---	---
		MY4N-D2*	MY4-D*	MY4IN-D2(S)*		
4	Bifurcated	MY4ZN-D2*	MY4Z-D*	MY4ZIN-D2(S)*		
Models with CR circuit for coil surge absorption (AC coil specification only)	2	MY2N-CR*	MY2-CR*		---	
	4	MY4N-CR*	MY4-CR*	MY4IN-CR(S)*		
		MY4ZN-CR*	MY4Z-CR*	MY4ZIN-CR(S)*		
Models with high contact reliability	4 Bifurcated	---	MY4Z-CBG			
Plastic sealed models	4	MYQ4N	MYQ4		MYQ4-02	
			MYQ4Z		MYQ4Z-02	
Latching models (coil latching)	2		MY2K		MY2K-02	
Hermetic models	4		MY4H		MY4H-0	
			MY4ZH		MY4ZH-0	

- Note:**
1. The models in this table are UL/CSA certified. This is indicated with a certification mark on the products. (This does not include models with high contact reliability or plastic sealed, latching, or hermetically sealed models.)
 2. Models with an asterisk (*) next to them are new versions.
 3. The standard models with plug-in terminals, models with coil surge absorption diodes, and models with coil surge absorption CR circuits were used in combination with the PYF-E and PYFS (2-pole and 4-pole) for the EC Declaration of Conformity. These products display the CE Marking.
 4. Products cannot be manufactured for the cells with a diagonal line. Ask your OMRON representative for details on manufacturing products for cells containing “---” in the above table.

Refer to *Connection Socket and Mounting Bracket Selection Table* on page 33 in *Options* for information on the possible combinations of Models with Plug-in Terminals and Sockets.

Miniature Power Relays: MY2



Refer to the standards certifications and compliance section of your OMRON website for the latest information on certified models.

Ordering Information

When your order, specify the rated voltage.

Classification	Model	Rated voltage (V)	
		Standard products	Made-to-order items
Standard models	MY2	12, 24, 100/110, or 200/220 VAC	110/120 or 220/240 VAC
		12, 24, 48, or 100/110 VDC	
Models with built-in operation indicators	MY2N	12, 24, 100/110, 110/120, 200/220, or 220/240 VAC	
		12, 24, 48, or 100/110 VDC	
Models with built-in diodes	MY2-D	12, 24, or 100/110 VDC	48 VDC
Models with built-in diodes and operation indicators	MY2N-D2	12, 24, 48, or 100/110 VDC	
Models with built-in CR circuits	MY2-CR	100/110 or 200/220 VAC	110/120 or 220/240 VAC
Models with built-in CR circuits and operation indicators	MY2N-CR	100/110 or 200/220 VAC	110/120 or 220/240 VAC

- Note:**
1. Ask your OMRON representative for details on the time required to deliver made-to-order products.
 2. Ask your OMRON representative for details on product specifications and the ability to manufacture products with voltages other than the above coil specifications.
 3. The above models and specifications are new versions in the MY Series.
 4. Except for MY2(N)-CR Relays with the above voltage specifications, all Relays have a height of 53 mm or less. If Mounting Brackets are required, refer to page 33 for selection information.

Ratings and Specifications

Ratings

Operating Coils (Standard Models)

Rated voltage (V)	Item	Rated current (mA)		Coil resistance (Ω)	Coil inductance (H)		Must-operate voltage (V)	Must-release voltage (V)	Maximum voltage (V)	Power consumption (VA, W)
		50 Hz	60 Hz		Armature OFF	Armature ON				
AC	12	106.5	91	46	0.17	0.33	80% max. *1	30% min. *2	110% of rated voltage	Approx. 1.0 to 1.2 (at 60 Hz)
	24	53.8	46	180	0.69	1.3				
	100/110	11.7/12.9	10/11	3,750	14.54	24.6				
	110/120	9.9/10.8	8.4/9.2	4,430	19.2	32.1				
	200/220	6.2/6.8	5.3/5.8	12,950	54.75	94.07				
	220/240	4.8/5.3	4.2/4.6	18,790	83.5	136.4				
DC	12	72.7		165	0.73	1.37	10% min. *2			Approx. 0.9
	24	36.3		662	3.2	5.72				
	48	17.6		2,725	10.6	21.0				
	100/110	8.7/9.6		11,440	45.6	86.2				

- Note:**
1. The rated current and coil resistance are measured at a coil temperature of 23°C with tolerances of +15%/–20% for the AC rated current and ±15% for the DC coil resistance.
 2. The AC coil resistance and inductance values are reference values only (at 60 Hz).
 3. Operating characteristics were measured at a coil temperature of 23°C.
 4. The maximum voltage capacity was measured at an ambient temperature of 23°C.
- *1. There is variation between products, but actual values are 80% max.
To ensure operation, apply at least 80% of the rated value (at a coil temperature of +23°C).
- *2. There is variation between products, but actual values are 30% minimum for AC and 10% minimum for DC. To ensure release, use a value that is lower than the specified value.

Contact Ratings

Item	Load	Resistive load	Inductive load (cos φ = 0.4, L/R = 7 ms)
Rated load		5 A at 220 VAC 5 A at 24 VDC	2 A at 220 VAC 2 A at 24 VDC
Rated carry current		5 A	
Maximum contact voltage		250 VAC, 125 VDC	
Maximum contact current		5 A	
Contact configuration		DPDT	
Contact structure		Single	
Contact materials		Ag	

Item	Type	Standard models	Model with built-in operation indicator, diode, or CR circuit
Ambient operating temperature*1		–55 to 70°C	–55 to 60°C*2
Ambient operating humidity		5% to 85%	

- *1. With no icing or condensation.
*2. This limitation is due to the diode junction temperature and elements used.

Characteristics

Item	Type	Standard models	Models with built-in operation indicators	Models with built-in CR circuits	Models with built-in diodes	Model with built-in operation indicator and diode	Model with built-in operation indicator and CR circuit
Contact resistance*1		50 mΩ max.					
Operation time*2		20 ms max.					
Release time*2		20 ms max.					
Maximum operating frequency	Mechanical	18,000 operations/h					
	Rated load	1,800 operations/h					
Insulation resistance*3		100 MΩ min.					
Dielectric strength	Between coil and contacts	2,000 VAC at 50/60 Hz for 1 min.					
	Between contacts of different polarity						
	Between contacts of the same polarity						
Vibration resistance	Destruction	10 to 55 to 10 Hz, 0.5-mm single amplitude (1.0-mm double amplitude)					
	Malfunction	10 to 55 to 10 Hz, 0.5-mm single amplitude (1.0-mm double amplitude)					
Shock resistance	Destruction	1,000 m/s ²					
	Malfunction	200 m/s ²					
Endurance	Mechanical	AC: 50,000,000 operations min. DC: 100,000,000 operations min. (switching frequency: 18,000 operations/h)					
	Electrical*4	500,000 operations min. (rated load, switching frequency: 1,800 operations/h)					

Item	Number of poles	2 poles
Failure rate P value (reference value)*5		1 mA at 5 VDC
Weight		Approx. 35 g

Note: These are initial values.

*1. Measurement conditions: 1 A at 5 VDC using the voltage drop method.

*2. Measurement conditions: With rated operating power applied.
Ambient temperature condition: 23°C

*3. Measurement conditions: For 500 VDC applied to the same location as for dielectric strength measurement.

*4. Ambient temperature condition: 23°C

*5. This value was measured at a switching frequency of 120 operations per minute.

Dimensions

(Unit: mm)

MY2, MY2N, MY2-D, MY2N-D2, MY2-CR, and MY2N-CR

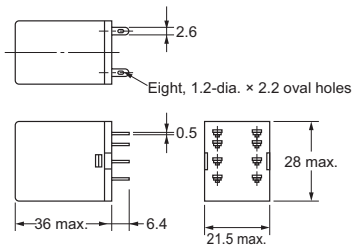
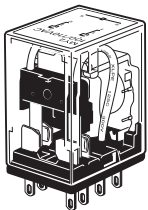

Terminal Arrangement/Internal Connections (Bottom View) Standard Models

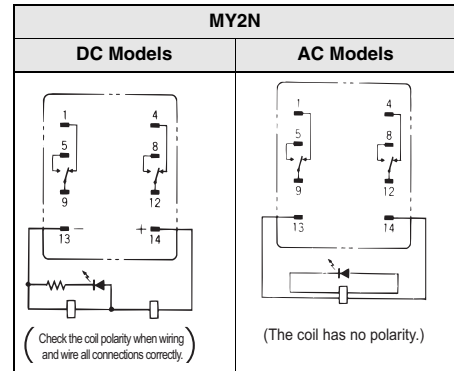
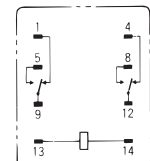

- Note:**
1. An AC model has coil disconnection self-diagnosis.
 2. For the DC models, check the coil polarity when wiring and wire all connections correctly.
 3. The indicator is red for AC and green for DC.
 4. The operation indicator indicates the energization of the coil and does not represent contact operation.

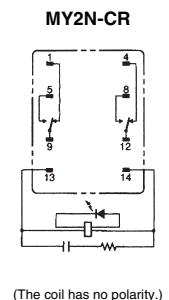
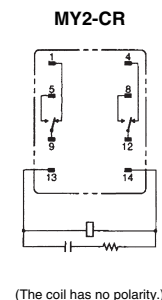
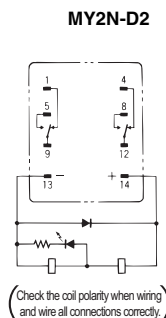
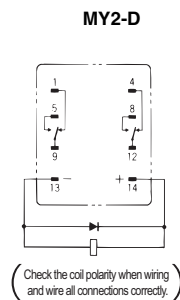

Miniature Power Relays: MY2Z



Refer to the standards certifications and compliance section of your OMRON website for the latest information on certified models.

Ordering Information

When your order, specify the rated voltage.

Classification	Model	Rated voltage (V)	
		Standard products	Made-to-order items
Standard models	MY2Z	100/110 or 200/220 VAC	12, 24, 100/120, or 200/240 VAC
		12 or 24 VDC	48 or 100/110 VDC
Models with built-in operation indicators	MY2ZN	100/110 or 200/220 VAC	12, 24, 100/120, or 200/240 VAC
		24 VDC	12, 48, or 100/110 VDC
Models with built-in diodes	MY2Z-D	24 VDC	12 or 100/110 VDC
Models with built-in diodes and operation indicators	MY2ZN-D2	24 or 100/110 VDC	12 VDC
Models with built-in CR circuits	MY2Z-CR		100/110 or 200/220 VAC
Models with built-in CR circuits and operation indicators	MY2ZN-CR	100/110 VAC	200/220 VAC

Note: 1. Ask your OMRON representative for details on the time required to deliver made-to-order products.

2. Ask your OMRON representative for details on product specifications and the ability to manufacture products with voltages other than the above coil specifications.

Ratings and Specifications

Ratings

Operating Coil (Standard Models)

Rated voltage (V)	Item	Rated current (mA)		Coil resistance (Ω)	Coil inductance (H)		Must-operate voltage (V)	Must-release voltage (V)	Maximum voltage (V)	Power consumption (VA, W)
		50 Hz	60 Hz		Armature OFF	Armature ON				
AC	12	106.5	91	46	0.17	0.33	80% max.*1	30% min.*2	110% of rated voltage	Approx. 1.0 to 1.2 (at 60 Hz)
	24	53.8	46	180	0.69	1.3				
	100/110	11.7/12.9	10/11	3,750	14.54	24.6				
	110/120	9.9/10.8	8.4/9.2	4,430	19.2	32.1				
	200/220	6.2/6.8	5.3/5.8	12,950	54.75	94.07				
DC	220/240	4.8/5.3	4.2/4.6	18,790	83.5	136.4	10% min.*2	Approx. 0.9		
	12	75		160	0.73	1.37				
	24	36.9		650	3.2	5.72				
	48	18.5		2,600	10.6	21.0				
	100/110	9.1/10		11,000	45.6	86.2				

Note: 1. The rated current and coil resistance are measured at a coil temperature of 23°C with tolerances of +15%/–20% for the AC rated current and ±15% for the DC coil resistance.

2. The AC coil resistance and inductance values are reference values only (at 60 Hz).

3. Operating characteristics were measured at a coil temperature of 23°C.

4. The maximum voltage capacity was measured at an ambient temperature of 23°C.

*1. There is variation between products, but actual values are 80% max.

To ensure operation, apply at least 80% of the rated value

*2. There is variation between products, but actual values are 30% minimum for AC and 10% minimum for DC. To ensure release, use a value that is lower than the specified value.

Contact Ratings

Item	Load	Inductive load (cos φ = 0.4, L/R = 7 ms)	
		Resistive load	
Rated load	5 A at 220 VAC 5 A at 24 VDC	2 A at 220 VAC 2 A at 24 VDC	
Rated carry current	5 A		
Maximum contact voltage	250 VAC, 125 VDC		
Maximum contact current	5 A		
Contact configuration	DPDT		
Contact structure	Bifurcated		
Contact materials	Au plating + Ag		

Item	Type	Standard models	Model with built-in operation indicator, diode, or CR circuit
Ambient operating temperature*1		–55 to 70° C	–55 to 60° C*2
Ambient operating humidity		5% to 85%	

*1. With no icing or condensation.

*2. This limitation is due to the diode junction temperature and elements used.

Characteristics

Item	Type	Standard models	Models with built-in operation indicators	Models with built-in diodes	Model with built-in operation indicator and diode	Models with built-in CR circuits	Models with built-in CR circuits and operation indicators
Contact resistance*1		50 mΩ max.					
Operation time*2		20 ms max.					
Release time*2		20 ms max.					
Maximum operating frequency	Mechanical	18,000 operations/h					
	Rated load	1,800 operations/h					
Insulation resistance*3		100 MΩ min.					
Dielectric strength	Between coil and contacts	2,000 VAC at 50/60 Hz for 1 min.					
	Between contacts of different polarity						
	Between contacts of the same polarity						
Vibration resistance	Destruction	10 to 55 to 10 Hz, 0.5-mm single amplitude (1.0-mm double amplitude)					
	Malfunction	10 to 55 to 10 Hz, 0.5-mm single amplitude (1.0-mm double amplitude)					
Shock resistance	Destruction	1,000 m/s ²					
	Malfunction	200 m/s ²					
Endurance	Mechanical	50,000,000 operations min. (operating frequency: 18,000 operations/h)					
	Electrical*4	200,000 operations min. (rated load, switching frequency: 1,800 operations/h)					

Item	Number of poles	2 poles
Failure rate P value (reference value)*5		100 μA at 1 VDC
Weight		Approx. 35 g

Note: These are initial values.

*1. Measurement conditions: 1 A at 5 VDC using the voltage drop method.

*2. Measurement conditions: With rated operating power applied.

Ambient temperature condition: 23° C

*3. Measurement conditions: For 500 VDC applied to the same location as for dielectric strength measurement.

*4. Ambient temperature condition: 23° C

*5. This value was measured at a switching frequency of 120 operations per minute.

Dimensions

(Unit: mm)

MY2Z, MY2ZN, MY2Z-D, MY2ZN-D2, MY2Z-CR, and MY2ZN-CR

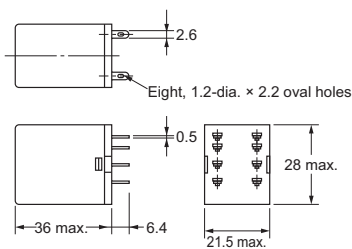
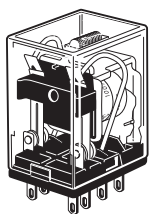

* For the MY2Z-CR and MY2ZN-CR, this dimension is 53 mm max.

Terminal Arrangement/ Internal Connections (Bottom View) Standard Models

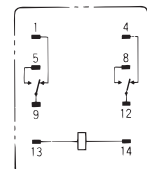

(The coil has no polarity.)

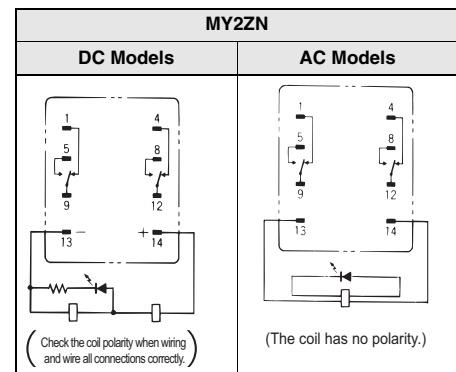

Note: 1. An AC model has coil disconnection self-diagnosis.

2. For the DC models, check the coil polarity when wiring and wire all connections correctly.

3. The indicator is red for AC and green for DC.

4. The operation indicator indicates the energization of the coil and does not represent contact operation.

MY2Z-D

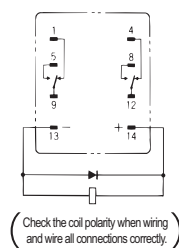

MY2ZN-D2

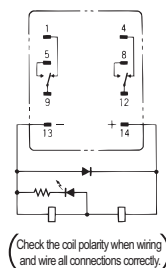

MY2Z-CR

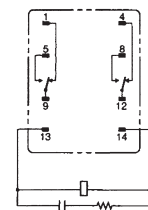

MY2ZN-CR

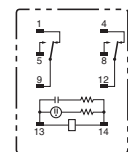

Miniature Power Relays: MY3



Refer to the standards certifications and compliance section of your OMRON website for the latest information on certified models.

Ordering Information

When your order, specify the rated voltage.

Classification	Model	Rated voltage (V)	
		Standard products	Made-to-order items
Standard models	MY3	24, 100/110, 200/220, or 220/240 VAC	12, or 110/120 VAC
		12, 24, or 100/110 VDC	48 VDC
Models with built-in operation indicators	MY3N	24, 100/110, 200/220, or 220/240 VAC	12, or 110/120 VAC
		24 VDC	12, 48, or 100/110 VDC
Models with built-in diodes	MY3-D	24 VDC	12 or 100/110 VDC
Models with built-in diodes and operation indicators	MY3N-D2	24 VDC	12 or 100/110 VDC

Note: 1. Ask your OMRON representative for details on the time required to deliver made-to-order products.
2. Ask your OMRON representative for details on product specifications and the ability to manufacture products with voltages other than the above coil specifications.

Ratings and Specifications

Ratings

Operating Coil (Standard Models)

Rated voltage (V)	Item	Rated current (mA)		Coil resistance (Ω)	Coil inductance (H)		Must-operate voltage (V)	Must-release voltage (V)	Maximum voltage (V)	Power consumption (VA, W)
		50 Hz	60 Hz		Armature OFF	Armature ON				
AC	12	106.5	91	46	0.17	0.33	80% max.*1	30% min.*2	110% of rated voltage	Approx. 1.0 to 1.2 (at 60 Hz)
	24	53.8	46	180	0.69	1.3				
	100/110	11.7/12.9	10/11	3,750	14.54	24.6				
	110/120	9.9/10.8	8.4/9.2	4,430	19.2	32.1				
	200/220	6.2/6.8	5.3/5.8	12,950	54.75	94.07				
DC	12	75		160	0.73	1.37	10% min.*2			Approx. 0.9 to 1.1 (at 60 Hz)
	24	36.9		650	3.2	5.72				
	48	18.5		2,600	10.6	21.0				
	100/110	9.1/10		11,000	45.6	86.2				

Note: 1. The rated current and coil resistance are measured at a coil temperature of 23°C with tolerances of +15%/–20% for the AC rated current and ±15% for the DC coil resistance.
2. The AC coil resistance and inductance values are reference values only (at 60 Hz).
3. Operating characteristics were measured at a coil temperature of 23°C.
4. The maximum voltage capacity was measured at an ambient temperature of 23°C.

*1. There is variation between products, but actual values are 80% max.

To ensure operation, apply at least 80% of the rated value

*2. There is variation between products, but actual values are 30% minimum for AC and 10% minimum for DC. To ensure release, use a value that is lower than the specified value.

Contact Ratings

Item	Load	Resistive load	Inductive load (cos φ = 0.4, L/R = 7 ms)
Rated load		5 A at 220 VAC 5 A at 24 VDC	2 A at 220 VAC 2 A at 24 VDC
Rated carry current		5 A	
Maximum contact voltage		250 VAC, 125 VDC	
Maximum contact current		5 A	
Contact configuration		3PDT	
Contact structure		Single	
Contact materials		Ag	

Item	Type	Standard models	Operation indicator and diode
Ambient operating temperature*1		–55 to 70° C	–55 to 60° C*2
Ambient operating humidity		5% to 85%	

*1. With no icing or condensation.

*2. This limitation is due to the diode junction temperature and elements used.

Characteristics

Item	Type	Standard models	Models with built-in operation indicators	Models with built-in diodes	Model with built-in operation indicator and diode
Contact resistance*1		50 mΩ max.			
Operation time*2		20 ms max.			
Release time*2		20 ms max.			
Maximum operating frequency	Mechanical	18,000 operations/h			
	Rated load	1,800 operations/h			
Insulation resistance*3		100 MΩ min.			
Dielectric strength	Between coil and contacts	2,000 VAC at 50/60 Hz for 1 min.			
	Between contacts of different polarity				
	Between contacts of the same polarity				
Vibration resistance	Destruction	10 to 55 to 10 Hz, 0.5-mm single amplitude (1.0-mm double amplitude)			
	Malfunction	10 to 55 to 10 Hz, 0.5-mm single amplitude (1.0-mm double amplitude)			
Shock resistance	Destruction	1,000 m/s ²			
	Malfunction	200 m/s ²			
Endurance	Mechanical	AC: 50,000,000 operations min. DC: 100,000,000 operations min. (switching frequency: 18,000 operations/h)			
	Electrical*4	500,000 operations min. (rated load, switching frequency: 1,800 operations/h)			

Item	Number of poles	3 poles
Failure rate P value (reference value)*5	1 mA at 5 VDC	
Weight	Approx. 35 g	

Note: These are initial values.

*1. Measurement conditions: 1 A at 5 VDC using the voltage drop method

*2. Measurement conditions: With rated operating power applied.

Ambient temperature condition: 23°C

*3. Measurement conditions: For 500 VDC applied to the same location as for dielectric strength measurement.

*4. Ambient temperature condition: 23°C

*5. This value was measured at a switching frequency of 120 operations per minute.

Dimensions

(Unit: mm)

MY3, MY3N, MY3-D, and MY3N-D2

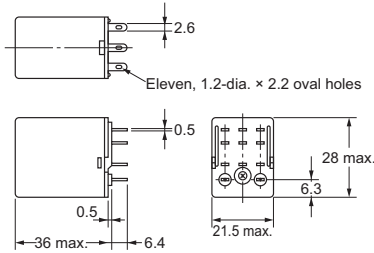
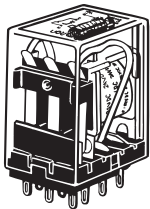

Terminal Arrangement/
Internal Connections
(Bottom View)
Standard Models

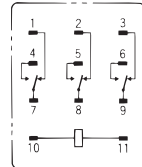

(The coil has no polarity.)

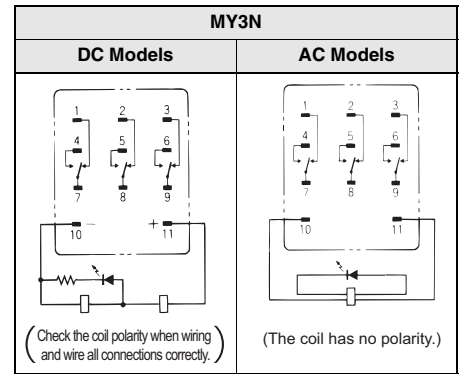

- Note:
1. An AC model has coil disconnection self-diagnosis.
 2. For the DC models, check the coil polarity when wiring and wire all connections correctly.
 3. The indicator is red for AC and green for DC.
 4. The operation indicator indicates the energization of the coil and does not represent contact operation.

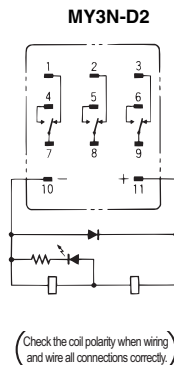
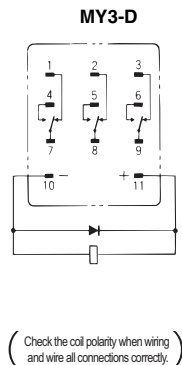

Miniature Power Relays: MY4



Refer to the standards certifications and compliance section of your OMRON website for the latest information on certified models.

Ordering Information

When your order, specify the rated voltage.

Classification	Model	Rated voltage (V)	
		Standard products	Made-to-order items
Standard models	MY4	24, 100/110, or 200/220 VAC	12, 110/120, or 220/240 VAC
		12, 24, 48, or 100/110 VDC	
Models with built-in operation indicators	MY4N	12, 24, 100/110, 110/120, 200/220, or 220/240 VAC	
		12, 24, 48, or 100/110 VDC	
Models with built-in diodes	MY4-D	12, 24, 48, or 100/110 VDC	
Models with built-in diodes and operation indicators	MY4N-D2	12, 24, or 100/110 VDC	48 VDC
Models with built-in CR circuits	MY4-CR	100/110 or 200/220 VAC	110/120 or 220/240 VAC
Models with built-in CR circuits and operation indicators	MY4N-CR	100/110, 110/120, or 200/220 VAC	220/240 VAC

- Note:**
1. Ask your OMRON representative for details on the time required to deliver made-to-order products.
 2. Ask your OMRON representative for details on product specifications and the ability to manufacture products with voltages other than the above coil specifications.
 3. The above models and specifications are new versions in the MY Series.
 4. Except for MY4(N)-CR Relays with the above voltage specifications, all Relays have a height of 53 mm or less. If Mounting Brackets are required, refer to page 33 for selection information.

Ratings and Specifications

Ratings

Operating Coil (Standard Models)

Rated voltage (V)	Item	Rated current (mA)		Coil resistance (Ω)	Coil inductance (H)		Must-operate voltage (V)	Must-release voltage (V)	Maximum voltage (V)	Power consumption (VA, W)
		50 Hz	60 Hz		Armature OFF	Armature ON				
AC	12	106.5	91	46	0.17	0.33	80% max.*1	30% min.*2	110% of rated voltage	Approx. 1.0 to 1.2 (at 60 Hz)
	24	53.8	46	180	0.69	1.3				
	100/110	11.7/12.9	10/11	3,750	14.54	24.6				
	110/120	9.9/10.8	8.4/9.2	4,430	19.2	32.1				
	200/220	6.2/6.8	5.3/5.8	12,950	54.75	94.07				
	220/240	4.8/5.3	4.2/4.6	18,790	83.5	136.4				
DC	12	72.7		165	0.73	1.37	10% min.*2			Approx. 0.9
	24	36.3		662	3.2	5.72				
	48	17.6		2,725	10.6	21.0				
	100/110	8.7/9.6		11,440	45.6	86.2				

- Note:**
1. The rated current and coil resistance are measured at a coil temperature of 23°C with tolerances of +15%/–20% for the AC rated current and ±15% for the DC coil resistance.
 2. The AC coil resistance and inductance values are reference values only (at 60 Hz).
 3. Operating characteristics were measured at a coil temperature of 23°C.
 4. The maximum voltage capacity was measured at an ambient temperature of 23°C.

*1. There is variation between products, but actual values are 80% max.

To ensure operation, apply at least 80% of the rated value

*2. There is variation between products, but actual values are 30% minimum for AC and 10% minimum for DC. To ensure release, use a value that is lower than the specified value.

Contact Ratings

Item	Load	Resistive load	Inductive load (cos φ = 0.4, L/R = 7 ms)
Rated load		3 A at 220 VAC 3 A at 24 VDC	0.8 A at 220 VAC 1.5 A at 24 VDC
Rated carry current		3 A	
Maximum contact voltage		250 VAC, 125 VDC	
Maximum contact current		3 A	
Contact configuration		4PDT	
Contact structure		Single	
Contact materials		Au cladding + Ag alloy	

Item	Type	Standard models	Model with built-in operation indicator, diode, or CR circuit
Ambient operating temperature*1		–55 to 70° C	–55 to 60° C*2
Ambient operating humidity		5% to 85%	

*1. With no icing or condensation.

*2. This limitation is due to the diode junction temperature and elements used.

Characteristics

Item	Type	Standard models	Models with built-in operation indicators	Models with built-in CR circuits	Models with built-in diodes	Model with built-in operation indicator and diode	Model with built-in operation indicator and CR circuit
Contact resistance*1		50 mΩ max.					
Operation time*2		20 ms max.					
Release time*2		20 ms max.					
Maximum operating frequency	Mechanical	18,000 operations/h					
	Rated load	1,800 operations/h					
Insulation resistance*3		100 MΩ min.					
Dielectric strength	Between coil and contacts	2,000 VAC at 50/60 Hz for 1 min.					
	Between contacts of different polarity						
	Between contacts of the same polarity						
Vibration resistance	Destruction	10 to 55 to 10 Hz, 0.5-mm single amplitude (1.0-mm double amplitude)					
	Malfunction	10 to 55 to 10 Hz, 0.5-mm single amplitude (1.0-mm double amplitude)					
Shock resistance	Destruction	1,000 m/s ²					
	Malfunction	200 m/s ²					
Endurance	Mechanical	AC: 50,000,000 operations min. DC: 100,000,000 operations min. (switching frequency: 18,000 operations/h)					
	Electrical*4	200,000 operations min. (rated load, switching frequency: 1,800 operations/h)					

Item	Number of poles	4 poles
Failure rate P value (reference value)*5	1 mA at 1 VDC	
Weight	Approx. 35 g	

Note: These are initial values.

*1. Measurement conditions: 1 A at 5 VDC using the voltage drop method

*2. Measurement conditions: With rated operating power applied.
Ambient temperature condition: 23° C

*3. Measurement conditions: For 500 VDC applied to the same location as for dielectric strength measurement.

*4. Ambient temperature condition: 23° C

*5. This value was measured at a switching frequency of 120 operations per minute.

Engineering Data

List of Actual Load Endurance (Refer to *Engineering Data* on page 20.)

Model	Load type	Conditions	Switching frequency	Electrical durability (operations min.)
MY4 DC24V	AC magnetic switch	35 VA at 100 VAC Making current: 4 A, Steady-state current: 0.35 A	ON: 1s OFF: 3s	500,000
	DC solenoid	40 W at 24 VDC Steady-state current: 1.6 A, L/R = 10 ms Surge-absorbing diode connected	ON: 0.5s OFF: 1.5s	500,000
		20 W at 24 VDC Steady-state current: 0.8 A, L/R = 10 ms Surge-absorbing diode connected	ON: 0.5s OFF: 1.5s	1,000,000

Dimensions

(Unit: mm)

MY4, MY4N, MY4-D, MY4N-D2,
MY4-CR, and MY4N-CR

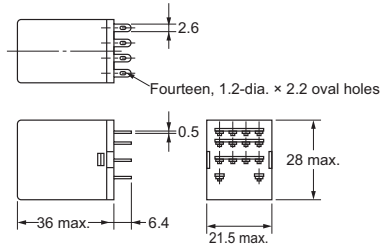
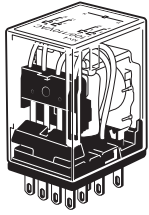

Terminal Arrangement/ Internal Connections (Bottom View) Standard Models

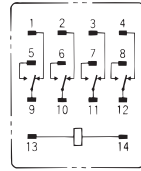

(The coil has no polarity.)

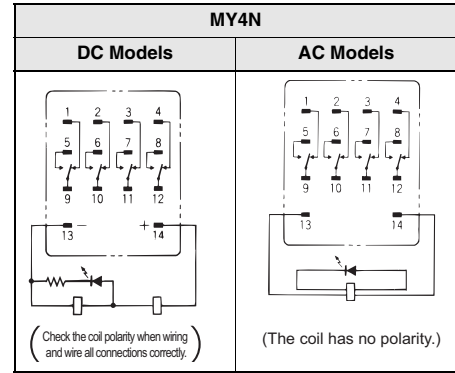

- Note:**
1. An AC model has coil disconnection self-diagnosis.
 2. For the DC models, check the coil polarity when wiring and wire all connections correctly.
 3. The indicator is red for AC and green for DC.
 4. The operation indicator indicates the energization of the coil and does not represent contact operation.

MY4-D

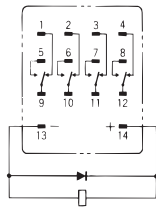

(Check the coil polarity when wiring and wire all connections correctly.)

MY4N-D2

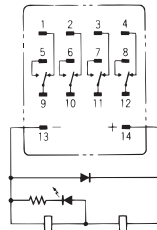

(Check the coil polarity when wiring and wire all connections correctly.)

MY4-CR

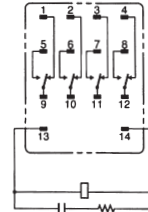

(The coil has no polarity.)

MY4N-CR

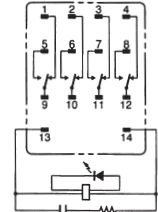

(The coil has no polarity.)

Miniature Power Relays: MY4Z



Refer to the standards certifications and compliance section of your OMRON website for the latest information on certified models.

Ordering Information

When your order, specify the rated voltage.

Classification	Model	Rated voltage (V)	
		Standard products	Made-to-order items
Standard models	MY4Z	100/110 or 200/220 VAC 12, 24, 48, or 100/110 VDC	110/120 or 220/240 VAC
Models with built-in operation indicators	MY4ZN	100/110 or 200/220 VAC 24 or 100/110 VDC	24, 110/120, or 220/240 VAC 12 or 48 VDC
Models with built-in diodes	MY4Z-D	24 or 100/110 VDC	12 or 48 VDC
Models with built-in diodes and operation indicators	MY4ZN-D2	12, 24, 48, or 100/110 VDC	
Models with built-in CR circuits	MY4Z-CR	100/110 or 200/220 VAC	110/120 or 220/240 VAC
Models with built-in CR circuits and operation indicators	MY4ZN-CR	100/110 or 200/220 VAC	110/120 or 220/240 VAC

- Note:**
1. Ask your OMRON representative for details on the time required to deliver made-to-order products.
 2. Ask your OMRON representative for details on product specifications and the ability to manufacture products with voltages other than the above coil specifications.
 3. The above models and specifications are new versions in the MY Series.

Ratings and Specifications

Ratings

Operating Coil (Standard Models)

Rated voltage (V)	Item	Rated current (mA)		Coil resistance (Ω)	Coil inductance (H)		Must-operate voltage (V)	Release voltage (V)	Maximum voltage (V)	Power consumption (VA, W)
		50 Hz	60 Hz		Armature OFF	Armature ON				
AC	12	106.5	91	46	0.17	0.33	80% max.*1	30% min.*2	110% of rated voltage	Approx. 1.0 to 1.2 (at 60 Hz)
	24	53.8	46	180	0.69	1.3				Approx. 0.9 to 1.1 (at 60 Hz)
	100/110	11.7/12.9	10/11	3,750	14.54	24.6				
	110/120	9.9/10.8	8.4/9.2	4,430	19.2	32.1				
	200/220	6.2/6.8	5.3/5.8	12,950	54.75	94.07				
	220/240	4.8/5.3	4.2/4.6	18,790	83.5	136.4				
DC	12	72.7		165	0.73	1.37	10% min.*2			Approx. 0.9
	24	36.3		662	3.2	5.72				
	48	17.6		2,725	10.6	21.0				
	100/110	8.7/9.6		11,440	45.6	86.2				

- Note:**
1. The rated current and coil resistance are measured at a coil temperature of 23°C with tolerances of +15%/–20% for the AC rated current and ±15% for the DC coil resistance.
 2. The AC coil resistance and inductance values are reference values only (at 60 Hz).
 3. Operating characteristics were measured at a coil temperature of 23°C.
 4. The maximum voltage capacity was measured at an ambient temperature of 23°C.

*1. There is variation between products, but actual values are 80% max.

To ensure operation, apply at least 80% of the rated value

*2. There is variation between products, but actual values are 30% minimum for AC and 10% minimum for DC. To ensure release, use a value that is lower than the specified value.

Contact Ratings

Item	Load	Resistive load	Inductive load (cos φ = 0.4, L/R = 7 ms)
Rated load		3 A at 220 VAC 3 A at 24 VDC	0.8 A at 220 VAC 1.5 A at 24 VDC
Rated carry current		3 A	
Maximum contact voltage		250 VAC, 125 VDC	
Maximum contact current		3 A	
Contact configuration		4PDT	
Contact structure		Bifurcated	
Contact materials		Au cladding + Ag alloy	

Item	Type	Standard models	Model with built-in operation indicator, diode, or CR circuit
Ambient operating temperature*1		–55 to 70° C	–55 to 60° C
Ambient operating humidity		5% to 85%	

*1. With no icing or condensation.

*2. This limitation is due to the diode junction temperature and elements used.

Characteristics

Item	Type	Standard models	Models with built-in operation indicators	Models with built-in CR circuits	Models with built-in diodes	Model with built-in operation indicator and diode	Model with built-in operation indicator and CR circuit
Contact resistance*1		50 mΩ max.					
Operation time*2		20 ms max.					
Release time*2		20 ms max.					
Maximum operating frequency	Mechanical	18,000 operations/h					
	Rated load	1,800 operations/h					
Insulation resistance*3		100 MΩ min.					
Dielectric strength	Between coil and contacts	2,000 VAC at 50/60 Hz for 1 min.					
	Between contacts of different polarity						
	Between contacts of the same polarity						
Vibration resistance	Destruction	10 to 55 to 10 Hz, 0.5-mm single amplitude (1.0-mm double amplitude)					
	Malfunction	10 to 55 to 10 Hz, 0.5-mm single amplitude (1.0-mm double amplitude)					
Shock resistance	Destruction	1,000 m/s ²					
	Malfunction	200 m/s ²					
Endurance	Mechanical	20,000,000 operations min. (switching frequency: 18,000 operations/h)					
	Electrical*4	100,000 operations min. (rated load, switching frequency: 1,800 operations/h)					

Item	Number of poles	4 poles
Failure rate P value (reference value)*5		100 μA at 1 VDC
Weight		Approx. 35 g

Note: These are initial values.

*1. Measurement conditions: 1 A at 5 VDC using the voltage drop method

*2. Measurement conditions: With rated operating power applied.

Ambient temperature condition: 23° C

*3. Measurement conditions: For 500 VDC applied to the same location as for dielectric strength measurement.

*4. Ambient temperature condition: 23° C

*5. This value was measured at a switching frequency of 120 operations per minute.

Dimensions

(Unit: mm)

MY4Z, MY4ZN, MY4Z-D, MY4ZN-D2, MY4Z-CR, and MY4ZN-CR

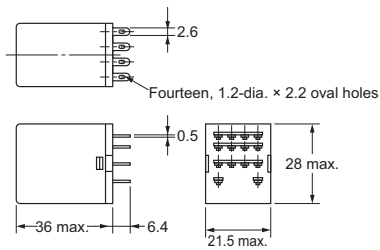
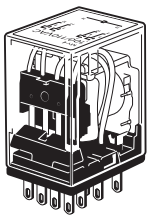

Terminal Arrangement/
Internal Connections
(Bottom View)
Standard Models

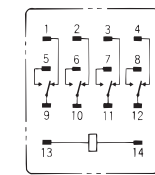

(The coil has no polarity.)

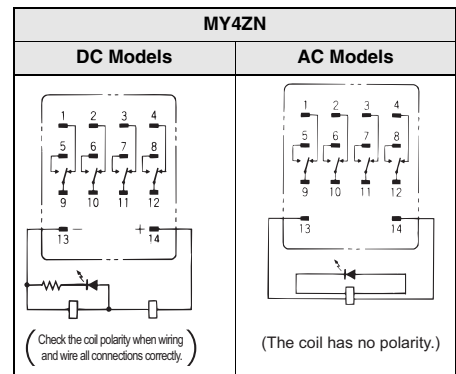

- Note:**
1. An AC model has coil disconnection self-diagnosis.
 2. For the DC models, check the coil polarity when wiring and wire all connections correctly.
 3. The indicator is red for AC and green for DC.
 4. The operation indicator indicates the energization of the coil and does not represent contact operation.

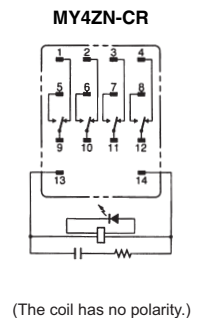
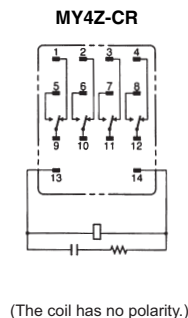
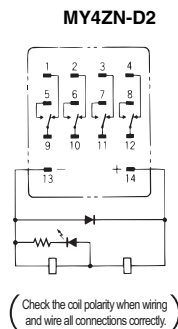
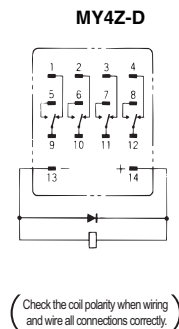

Miniature Power Relays with Latching Levers: MY(S) LR

Refer to the standards certifications and compliance section of your OMRON website for the latest information on certified models.

Ordering Information

Be sure to clearly indicate the rated voltage and add "(S)" when you place your order.
Example: MY2IN 110/110 VAC (S)

Classification	Contact configuration	Model	Rated voltage (V)	
			Standard products	Made-to-order items
Models with built-in operation indicators	2	MY2IN (S)	—	100/110 or 200/220 VAC
			12, 24, or 48 VDC	---
	4	MY4IN (S)	—	100/110 or 200/220 VAC
			12, 24, or 48 VDC	---
	4 bifurcated	MY4ZIN (S)	—	100/110 or 200/220 VAC
			—	12, 24, or 48 VDC
Models with built-in diode for coil surge absorption	2	MY2IN-D2 (S)	12 or 24 VDC	48 VDC
	4	MY4IN-D2 (S)	24 VDC	12 or 48 VDC
	4 bifurcated	MY4ZIN-D2 (S)	24 VDC	12 or 48 VDC
Models with built-in CR circuit for coil surge absorption	4	MY4IN-CR (S)	—	100/110 or 200/220 VAC
	4 bifurcated	MY4ZIN-CR (S)	—	100/110 or 200/220 VAC

- Note:** 1. Ask your OMRON representative for details on the time required to deliver made-to-order products.
2. Ask your OMRON representative for details on product specifications and the ability to manufacture products with voltages other than the above coil specifications.

Ratings and Specifications

Ratings

Operating Coil

Item	Rated voltage (V)	Rated current (mA)		Coil resistance (Ω)	Coil inductance (H)		Must-operate voltage (V)	Must-release voltage (V)	Maximum voltage (V)	Power consumption (VA, W)
		50 Hz	60 Hz		Armature OFF	Armature ON				
AC ¹	100/110	11.7/12.9	10/11	3,750	14.54	24.6	80% max.* ¹	30% min.* ²	110% of rated voltage	Approx. 0.9 to 1.1 (at 60 Hz)
	200/220	6.2/6.8	5.3/5.8	12,950	54.75	94.07				
DC ¹	12	75		160	0.73	1.37		10% min.* ²		Approx. 0.9
	24	37.7		636	3.2	5.72				
	48	18.8		2,560	10.6	21				

- Note:** 1. The rated current and coil resistance are measured at a coil temperature of 23°C with tolerances of +15%/–20% for the AC rated current and ±15% for the DC coil resistance.
2. The AC coil resistance and inductance values are reference values only (at 60 Hz).
3. Operating characteristics were measured at a coil temperature of 23°C.
4. The maximum voltage capacity was measured at an ambient temperature of 23°C.

*¹. There is variation between products, but actual values are 80% max. To ensure operation, apply at least 80% of the rated value.

*². There is variation between products, but actual values are 30% minimum for AC and 10% minimum for DC. To ensure release, use a value that is lower than the specified value.

Contact Ratings

Item	Number of poles Load	2 poles		4 poles		4 poles (bifurcated)	
		Resistive load (cos φ = 1)	Inductive load (cos φ = 0.4, L/R = 7 ms)	Resistive load (cos φ = 1)	Inductive load (cos φ = 0.4, L/R = 7 ms)	Resistive load (cos φ = 1)	Inductive load (cos φ = 0.4, L/R = 7 ms)
Rated load		5 A at 250 VAC 5 A at 30 VDC	2 A at 250 VAC 2 A at 30 VDC	3 A at 250 VAC 3 A at 30 VDC	0.8 A at 250 VAC 1.5 A at 30 VDC	3 A at 250 VAC 3 A at 30 VDC	0.8 A at 250 VAC 1.5 A at 30 VDC
Rated carry current		10 A*		5 A*			
Maximum contact voltage		250 VAC, 125 VDC					
Maximum contact current		10 A		5 A			
Contact configuration		Single		Single		Bifurcated	
Contact materials		Ag		Au cladding + Ag alloy		Au cladding + Ag alloy	

* If you use a Socket, do not exceed the rated carry current of the Socket.

Item	Type	Model with built-in operation indicator, diode, or CR circuit
Ambient operating temperature* ¹		–55 to 60° C* ²
Ambient operating humidity		5% to 85%

*¹. With no icing or condensation.

*². This limitation is due to the diode junction temperature and elements used.

Characteristics

Item	Type	2 poles	4 poles	4 poles (bifurcated)
Contact resistance*1		100 mΩ max.		
Operation time*2		20 ms max.		
Release time*2		20 ms max.		
Maximum operating frequency	Mechanical	18,000 operations/h		
	Rated load	1,800 operations/h		
Insulation resistance*3		1,000 MΩ min.		
Dielectric strength	Between coil and contacts	2,000 VAC at 50/60 Hz for 1 min.		
	Between contacts of different polarity			
	Between contacts of the same polarity			
Vibration resistance	Destruction	10 to 55 to 10 Hz, 0.5-mm single amplitude (1.0-mm double amplitude)		
	Malfunction	10 to 55 to 10 Hz, 0.5-mm single amplitude (1.0-mm double amplitude)		
Shock resistance	Destruction	1,000 m/s ²		
	Malfunction	200 m/s ²		
Endurance	Mechanical	AC: 50,000,000 operations min., DC: 100,000,000 operations min. (switching frequency: 18,000 operations/h)		20,000,000 operations min. (switching frequency: 18,000 operations/h)
	Electrical*4	500,000 operations min. (rated load, switching frequency: 1,800 operations/h)	200,000 operations min. (rated load, switching frequency: 1,800 operations/h)	100,000 operations min. (rated load, switching frequency: 1,800 operations/h)
Failure rate P value (reference value)*5		1 mA at 5 VDC	1 mA at 1 VDC	100 μA at 1 VDC
Weight		Approx. 35 g		

Note: These are initial values.

*1. Measurement conditions: 1 A at 5 VDC using the voltage drop method

*2. Measurement conditions: When rated operating power is applied and ambient temperature is 23° C

*3. Measurement conditions: For 500 VDC applied to the same location as for dielectric strength measurement.

*4. Ambient temperature condition: 23° C

*5. This value was measured at a switching frequency of 120 operations per minute.

Dimensions

List of Models

MY2IN (S)

MY2IN-D2 (S)

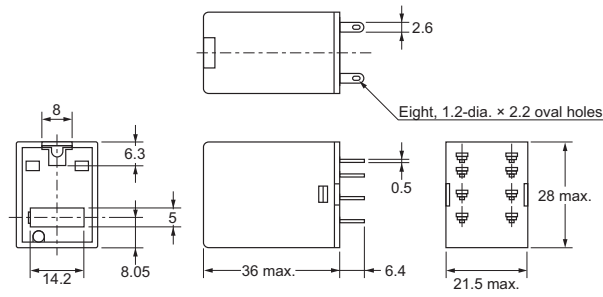
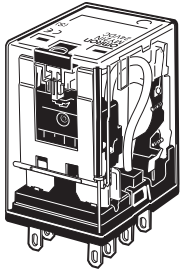

Terminal Arrangement/Internal Connections (Bottom View)

MY2IN(S)
(AC Model)

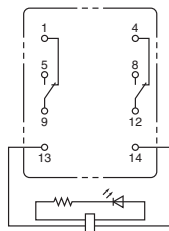

MY2IN(S)
(DC Models)

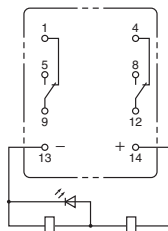

MY2IN-D2(S)
(DC Models Only)

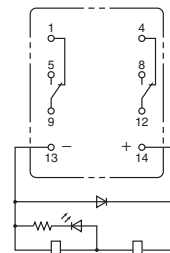

Note: For the DC models, check the coil polarity when wiring and wire all connections correctly.

MY4 (Z) IN (S)

MY4 (Z) IN-D2 (S)

MY4 (Z) IN-CR (S)

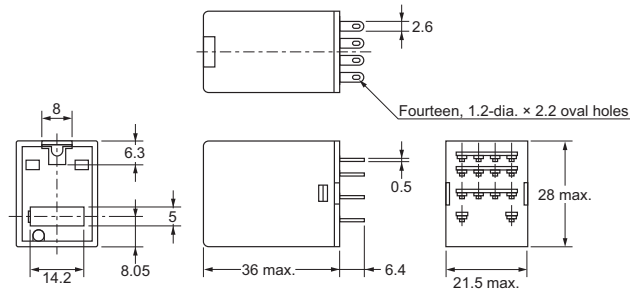
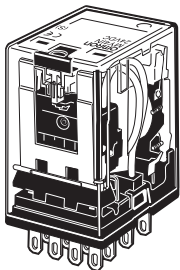

Terminal Arrangement/Internal Connections (Bottom View)

MY4(Z)IN(S)
(DC Models)

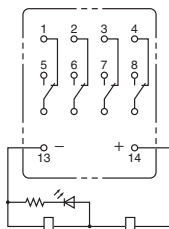

MY4(Z)IN(S)
(AC Models)

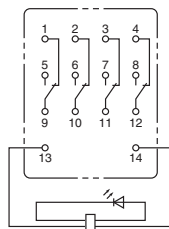

MY4(Z)IN-D2(S)
(DC Models Only)

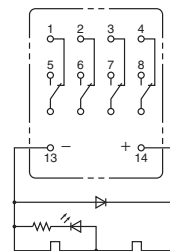

MY4(Z)IN-CR(S)
(AC Models Only)

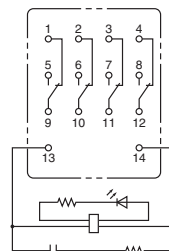

Note: For the DC models, check the coil polarity when wiring and wire all connections correctly.

Relays with PCB Terminals: MY□-02



Refer to the standards certifications and compliance section of your OMRON website for the latest information on certified models.

Ordering Information

When your order, specify the rated voltage.

Number of poles	Classification	Model	Rated voltage (V)	
			Standard products	Made-to-order items
2 poles	Models with single contacts	MY2-02	100/110, 200/220, or 200/240 VAC	12, 24, 100, or 110/120 VAC
			12, 24 or 48 VDC	100/110 VDC
3 poles	Models with single contacts	MY3-02	100/110 or 200/220 VAC	12, 24, 110/120, or 220/240 VAC
			24 VDC	12, 48, or 100/110 VDC
4 poles	Models with single contacts	MY4-02	100/110 or 200/220 VAC	12, 24, 110/120, or 220/240 VAC
			12, 24 or 100/110 VDC	48 VDC
	Bifurcated contacts	MY4Z-02	—	100/110, 110/120, or 200/220 VAC
			100/110 VDC	12, 24, or 48 VDC

Note: 1. Ask your OMRON representative for details on the time required to deliver made-to-order products.
 2. Ask your OMRON representative for details on product specifications and the ability to manufacture products with voltages other than the above coil specifications.

Ratings and Specifications

Ratings

Operating Coil (Standard Models)

Rated voltage (V)	Item	Rated current (mA)		Coil resistance (Ω)	Coil inductance (H)		Must-operate voltage (V)	Must-release voltage (V)	Maximum voltage (V)	Power consumption (VA, W)
	50 Hz	60 Hz	Armature OFF		Armature ON					
AC	12	106.5	91	46	0.17	0.33	80% max.*1	30% min.*2	110% of rated voltage	Approx. 1.0 to 1.2 (at 60 Hz)
	24	53.8	46	180	0.69	1.3				
	100/110	11.7/12.9	10/11	3,750	14.54	24.6				
	110/120	9.9/10.8	8.4/9.2	4,430	19.2	32.1				
	200/220	6.2/6.8	5.3/5.8	12,950	54.75	94.07				
	220/240	4.8/5.3	4.2/4.6	18,790	83.5	136.4	10% min.*2	Approx. 0.9		
DC	12	75		160	0.73	1.37				
	24	36.9		650	3.2	5.72				
	48	18.5		2,600	10.6	21.0				
	100/110	9.1/10		11,000	45.6	86.2				

Note: 1. The rated current and coil resistance are measured at a coil temperature of 23°C with tolerances of +15%/-20% for the AC rated current and ±15% for the DC coil resistance.
 2. The AC coil resistance and inductance values are reference values only (at 60 Hz).
 3. Operating characteristics were measured at a coil temperature of 23°C.
 4. The maximum voltage capacity was measured at an ambient temperature of 23°C.

*1. There is variation between products, but actual values are 80% max.
 To ensure operation, apply at least 80% of the rated value.

*2. There is variation between products, but actual values are 30% minimum for AC and 10% minimum for DC. To ensure release, use a value that is lower than the specified value.

Contact Ratings

Item	Number of poles Load	2 or 3 poles		4 poles		4 poles, bifurcated contacts	
		Resistive load	Inductive load (cos φ = 0.4, L/R = 7 ms)	Resistive load	Inductive load (cos φ = 0.4, L/R = 7 ms)	Resistive load	Inductive load (cos φ = 0.4, L/R = 7 ms)
Rated load		5 A at 220 VAC 5 A at 24 VDC	2 A at 220 VAC 2 A at 24 VDC	3 A at 220 VAC 3 A at 24 VDC	0.8 A at 220 VAC 1.5 A at 24 VDC	3 A at 220 VAC 3 A at 24 VDC	0.8 A at 220 VAC 1.5 A at 24 VDC
Rated carry current		5 A		3 A		3 A	
Maximum contact voltage		250 VAC, 125 VDC		250 VAC, 125 VDC		250 VAC, 125 VDC	
Maximum contact current		5 A		3 A		3 A	
Contact configuration		DPDT, 3PDT		4PDT		4PDT	
Contact structure		Single		Single		Bifurcated	
Contact materials		Ag		Au plating + Ag		Au plating + Ag	

Item	Type	Standard models
Ambient operating temperature*		-55 to 70° C
Ambient operating humidity		5% to 85%

* With no icing or condensation.

Characteristics

Item	Number of poles	2 or 3 poles	4 poles	4 poles, bifurcated contacts
Contact resistance*1		50 mΩ max.		
Operation time*2		20 ms max.		
Release time*2		20 ms max.		
Maximum operating frequency	Mechanical	18,000 operations/h		
	Rated load	1,800 operations/h		
Insulation resistance*3		100 MΩ min.		
Dielectric strength	Between coil and contacts	2,000 VAC at 50/60 Hz for 1 min.		
	Between contacts of different polarity	2,000 VAC at 50/60 Hz for 1 min.		
	Between contacts of the same polarity	1,000 VAC at 50/60 Hz for 1 min.		
Vibration resistance	Destruction	10 to 55 to 10 Hz, 0.5-mm single amplitude (1.0-mm double amplitude)		
	Malfunction	10 to 55 to 10 Hz, 0.5-mm single amplitude (1.0-mm double amplitude)		
Shock resistance	Destruction	1,000 m/s ²		
	Malfunction	200 m/s ²		
Endurance	Mechanical	AC: 50,000,000 operations min. DC: 100,000,000 operations min. (switching frequency: 18,000 operations/h)		AC: 20,000,000 operations min. (switching frequency: 18,000 operations/h)
	Electrical*4	500,000 operations min. (rated load, switching frequency: 1,800 operations/h)	200,000 operations min. (rated load, switching frequency: 1,800 operations/h)	100,000 operations min. (rated load, switching frequency: 1,800 operations/h)

Item	Number of poles	2 or 3 poles	4 poles	4 poles, bifurcated contacts
Failure rate P value (reference value)*5		1 mA at 5 VDC	1 mA at 1 VDC	100 μA at 1 VDC
Weight		Approx. 35 g		

Note: These are initial values.

*1. Measurement conditions: 1 A at 5 VDC using the voltage drop method

*2. Measurement conditions: With rated operating power applied.

Ambient temperature condition: 23° C

*3. Measurement conditions: For 500 VDC applied to the same location as for dielectric strength measurement.

*4. Ambient temperature condition: 23° C

*5. This value was measured at a switching frequency of 120 operations per minute.

Dimensions

(Unit: mm)

Relays with PCB Terminals

MY□-02

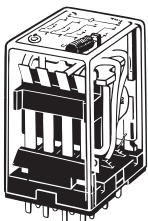

The figures and dimensions given here are for the MY4-02.

The 2-pole and 3-pole models conform to these dimensions.

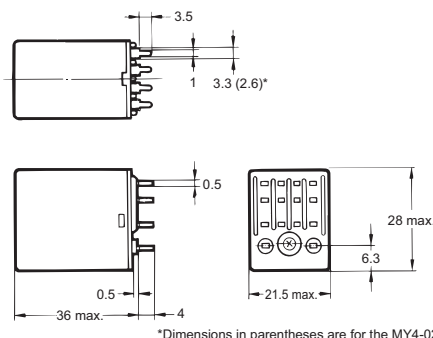

PCB Processing Dimensions (Bottom View)

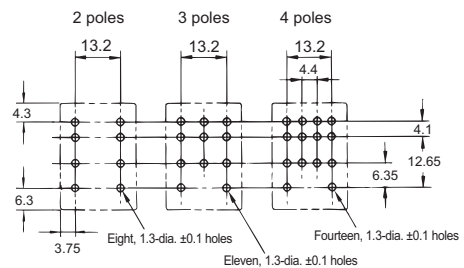

Note: 1. The dimensional tolerance is ±0.1.
2. Refer to the terminal arrangement and internal connections diagrams for the MY2, MY3, MY4, and MY4Z.

Case-surface-mounting Relays: MY□F



Refer to the standards certifications and compliance section of your OMRON website for the latest information on certified models.

Ordering Information

When your order, specify the rated voltage.

Number of poles	Classification	Model	Rated voltage (V)	
			Standard products	Made-to-order items
2 poles	Models with single contacts	MY2F	24, 110/110, 100/120 or 200/220 VAC	220/240 VAC
			12 or 24 VDC	48 or 100/110 VDC
3 poles	Models with single contacts	MY3F	100/110 VAC	24 or 200/220 VAC
			—	24 or 100/110 VDC
4 poles	Models with single contacts	MY4F	100/110 or 200/220 VAC	24 or 110/120 VAC
			12 or 24 VDC	48 or 100/110 VDC
	Bifurcated contacts	MY4ZF	200/220 VAC	—
			—	12 or 24 VDC

- Note:** 1. Ask your OMRON representative for details on the time required to deliver made-to-order products.
2. Ask your OMRON representative for details on product specifications and the ability to manufacture products with voltages other than the above coil specifications.

Ratings and Specifications

Ratings

Operating Coil (Standard Models)

Item	Rated voltage (V)	Rated current (mA)		Coil resistance (Ω)	Coil inductance (H)		Must-operate voltage (V)	Release voltage (V)	Maximum voltage (V)	Power consumption (VA, W)
		50 Hz	60 Hz		Armature OFF	Armature ON				
AC	24	53.8	46	180	0.69	1.3	80% max.*1	30% min.*2	110% of rated voltage	Approx. 1.0 to 1.2 (at 60 Hz)
	100/110	11.7/12.9	10/11	3,750	14.54	24.6				Approx. 0.9 to 1.1 (at 60 Hz)
	110/120	9.9/10.8	8.4/9.2	4,430	19.2	32.1				
	200/220	6.2/6.8	5.3/5.8	12,950	54.75	94.07				
	220/240	4.8/5.3	4.2/4.6	18,790	83.5	136.4				
DC	12	75		160	0.73	1.37	10% min.*2			Approx. 0.9
	24	36.9		650	3.2	5.72				
	48	18.5		2,600	10.6	21.0				
	100/110	9.1/10		11,000	45.6	86.2				

- Note:** 1. The rated current and coil resistance are measured at a coil temperature of 23°C with tolerances of +15%/-20% for the AC rated current and ±15% for the DC coil resistance.
2. The AC coil resistance and inductance values are reference values only (at 60 Hz).
3. Operating characteristics were measured at a coil temperature of 23°C.
4. The maximum voltage capacity was measured at an ambient temperature of 23°C.

*1. There is variation between products, but actual values are 80% max.

To ensure operation, apply at least 80% of the rated value

*2. There is variation between products, but actual values are 30% minimum for AC and 10% minimum for DC. To ensure release, use a value that is lower than the specified value.

Contact Ratings

Number of poles	Load	2 or 3 poles		4 poles	
		Resistive load	Inductive load (cos φ = 0.4, L/R = 7 ms)	Resistive load	Inductive load (cos φ = 0.4, L/R = 7 ms)
Rated load		5 A at 220 VAC 5 A at 24 VDC	2 A at 220 VAC 2 A at 24 VDC	3 A at 220 VAC 3 A at 24 VDC	0.8 A at 220 VAC 1.5 A at 24 VDC
Rated carry current		5 A		3 A	
Maximum contact voltage		250 VAC, 125 VDC		250 VAC, 125 VDC	
Maximum contact current		5 A		3 A	
Contact configuration		DPDT, 3PDT		4PDT	
Contact structure		Single		Single	
Contact materials		Ag		Au plating + Ag	

Item	Type	Standard models
Ambient operating temperature*		-55 to 70° C
Ambient operating humidity		5% to 85%

* With no icing or condensation.

Characteristics

Item	Number of poles	2 or 3 poles	4 poles
Contact resistance*1		50 mΩ max.	
Operation time*2		20 ms max.	
Release time*2		20 ms max.	
Maximum operating frequency	Mechanical	18,000 operations/h	
	Rated load	1,800 operations/h	
Insulation resistance*3		100 MΩ min.	
Dielectric strength	Between coil and contacts	2,000 VAC at 50/60 Hz for 1 min.	
	Between contacts of different polarity		
	Between contacts of the same polarity	1,000 VAC at 50/60 Hz for 1 min.	
Vibration resistance	Destruction	10 to 55 to 10 Hz, 0.5-mm single amplitude (1.0-mm double amplitude)	
	Malfunction	10 to 55 to 10 Hz, 0.5-mm single amplitude (1.0-mm double amplitude)	
Shock resistance	Destruction	1,000 m/s ²	
	Malfunction	200 m/s ²	
Endurance	Mechanical	AC: 50,000,000 operations min. DC: 100,000,000 operations min. (switching frequency: 18,000 operations/h)	
	Electrical*4	500,000 operations min. (rated load, switching frequency: 1,800 operations/h)	200,000 operations min. (rated load, switching frequency: 1,800 operations/h)

Item	Number of poles	2 or 3 poles	4 poles
Failure rate P value (reference value)		1 mA at 5 VDC	1 mA at 1 VDC
Weight		Approx. 35 g	

Note: These are initial values.

*1. Measurement conditions: 1 A at 5 VDC using the voltage drop method

*2. Measurement conditions: With rated operating power applied.

Ambient temperature condition: 23° C

*3. Measurement conditions: For 500 VDC applied to the same location as for dielectric strength measurement.

*4. Ambient temperature condition: 23° C

*5. This value was measured at a switching frequency of 120 operations per minute.

Dimensions

(Unit: mm)

Case-surface mounting MY□F



The above figure is for the MY4F.

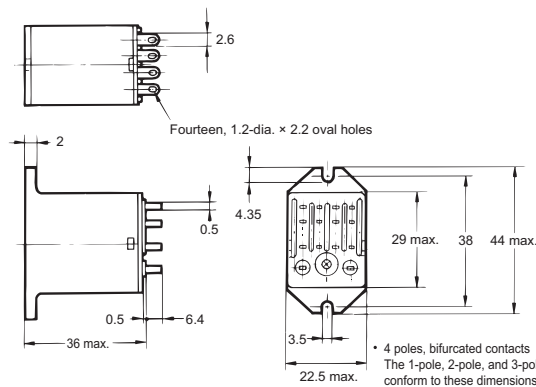

Mounting Hole Dimensions

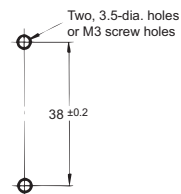

Note: Refer to the terminal arrangement and internal connections diagrams for the MY2, MY3, MY4, and MY4Z.

Engineering Data MY2, MY3, MY4, MY4Z, MY□-02, and MY□F

Engineering Data

Maximum Switching Capacity MY2 and MY3

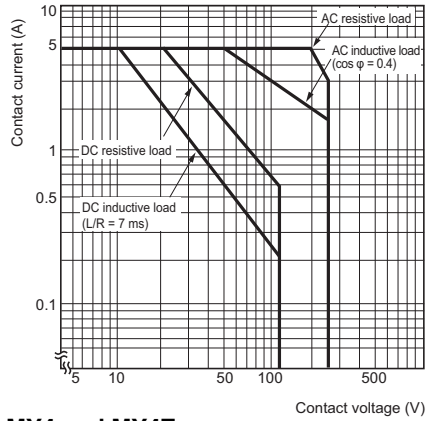

MY4 and MY4Z

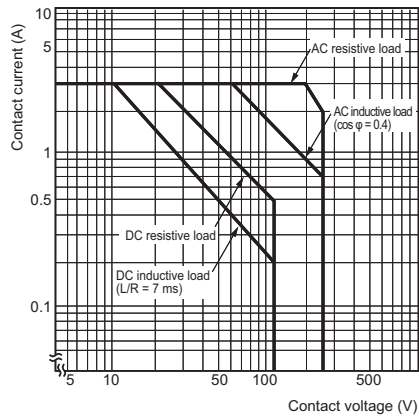

Endurance Curve MY2 and MY3

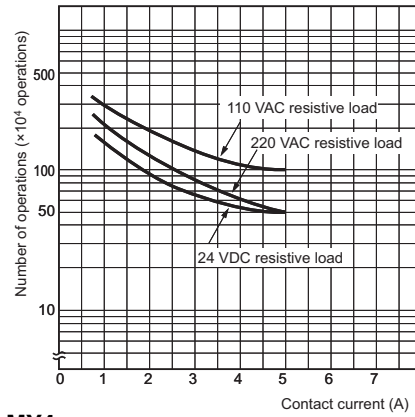

MY2 and MY3

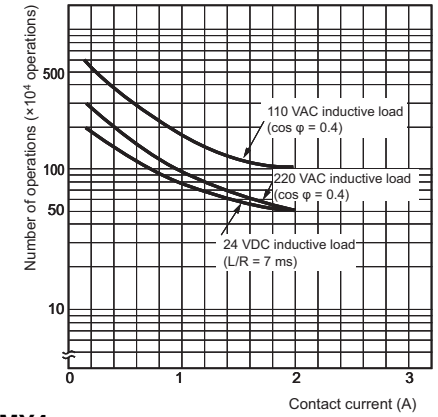

MY4

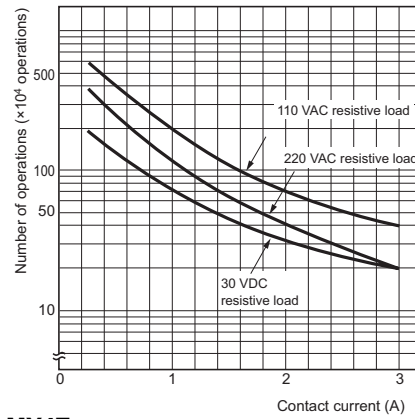

MY4

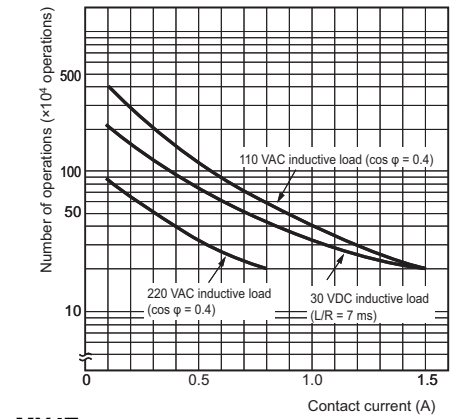

MY4Z

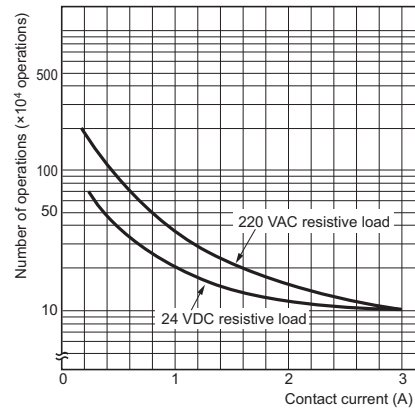

MY4Z

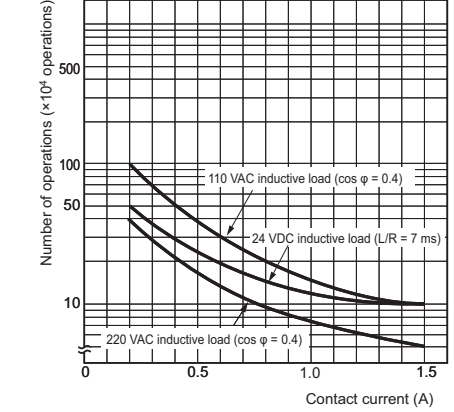

Ambient Temperature vs. Must-operate and Must-release Voltage MY2 AC Models

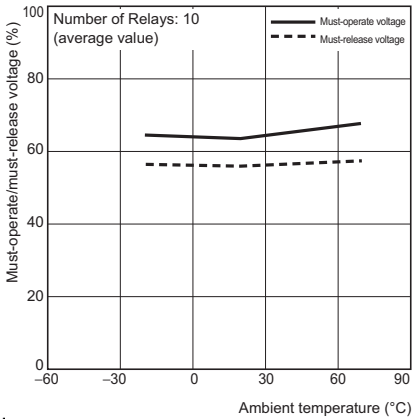

MY2 DC Models

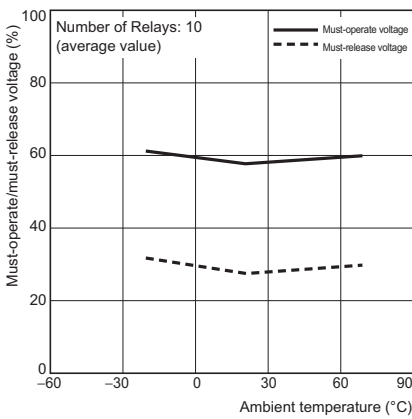

MY4 AC Models

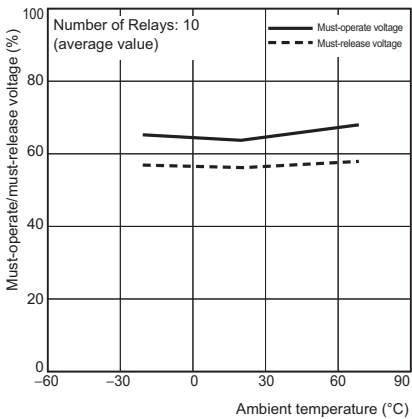

MY4 DC Models

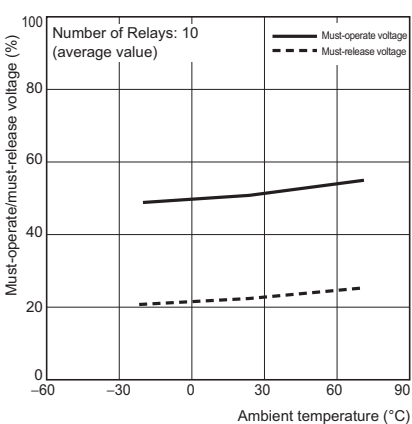

Ambient Temperature vs. Coil Temperature Rise

MY2 AC Models, 50 Hz

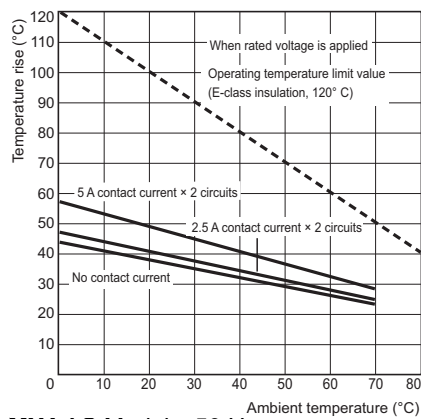

MY2 DC Models

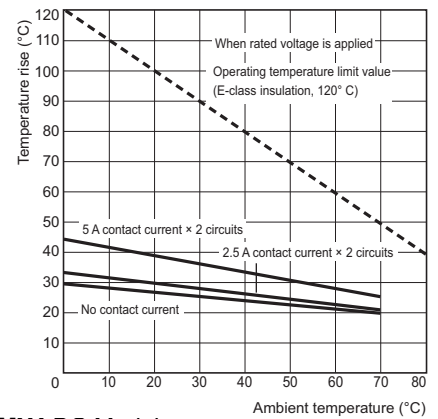

MY4 AC Models, 50 Hz

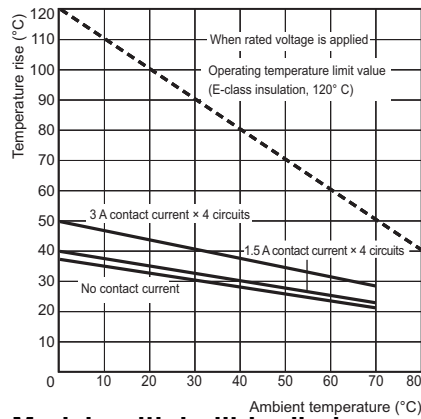

MY4 DC Models

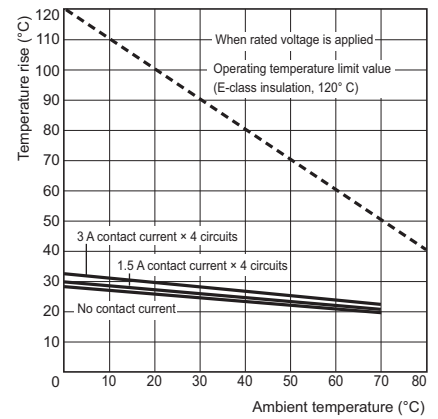

Models with built-in diodes

The diode absorbs surge from the coil. This type is best suited for applications with semiconductor circuits.

With Diode

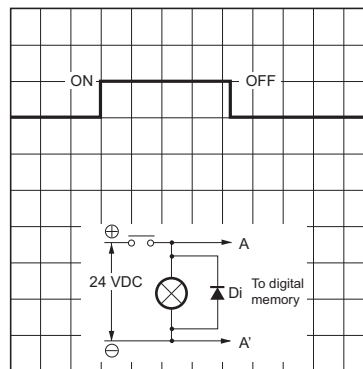

Without Diode

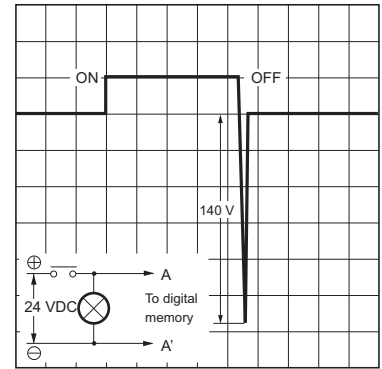

1. Make sure that the polarity is correct.
2. The release time will increase, but the 20-ms specification for standard models is satisfied.
3. Diode properties: The diode has a reversed dielectric strength of 1,000 V. Forward current: 1 A

Models with Built-in CR Circuits

With CR

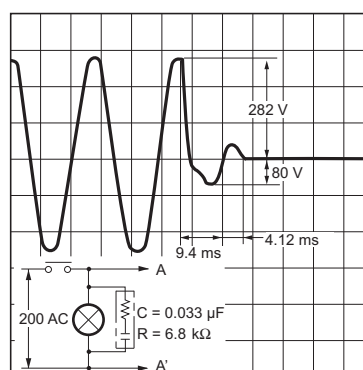

Without CR

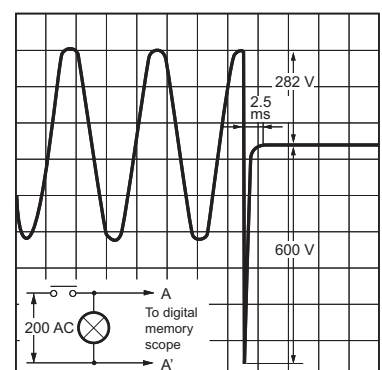

Engineering Data MY(S)

Engineering Data

Maximum Switching Capacity MY2(S)

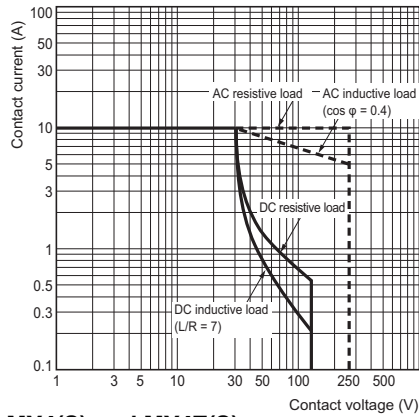

MY4(S) and MY4Z(S)

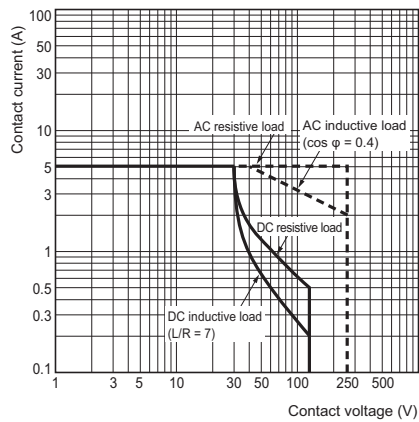

Endurance Curve MY2(S)

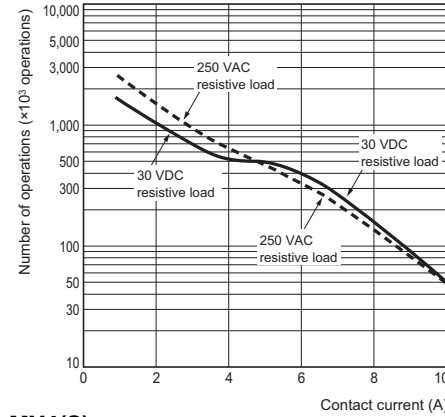

MY2(S)

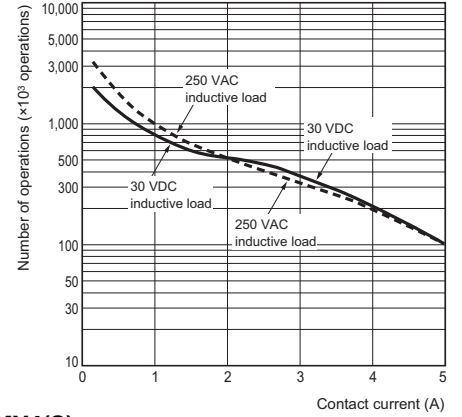

MY4(S)

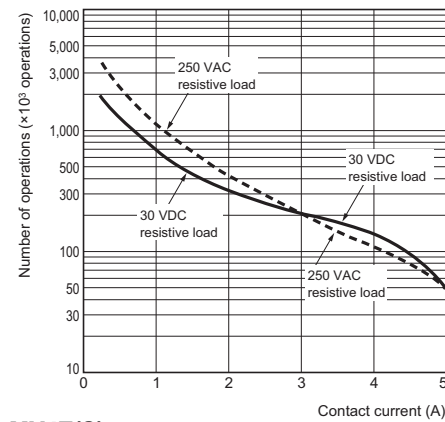

MY4(S)

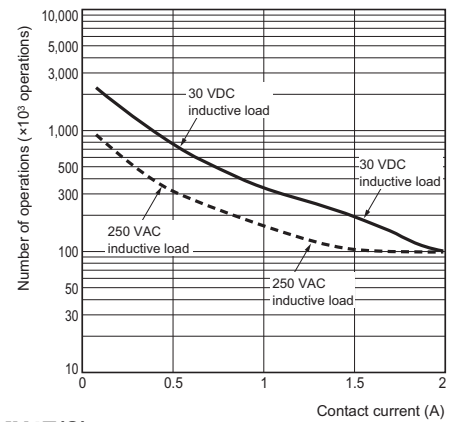

MY4Z(S)

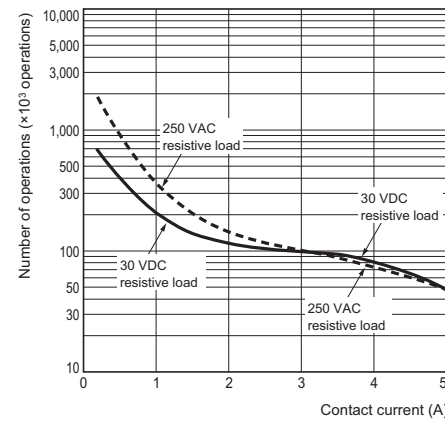

MY4Z(S)

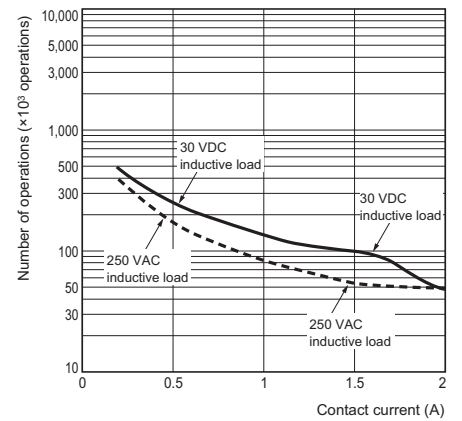

Common Specifications for MY2, MY3, MY4, MY4Z, MY□-02, MY□F, and MY(S)

Malfunctioning Shock

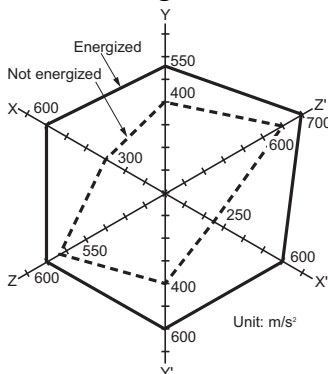

N = 20

Measurement: Shock was applied 3 times each in 6 directions along 3 axes with the Relay energized and not energized to check the shock values that cause the Relay to malfunction.

Criteria: Non-energized: 200 m/s²,
Energized: 200 m/s²

Shock direction

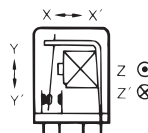

Detailed Information on Models Certified for Safety Standards, MY2Z, MY3, MY□-02, and MY□F

- Refer to *Model Number Structure* on page 1 for a list of applicable models.
- The standard models are certified for UL and CSA standards.
- The rated values for safety standard certification are not the same as individually defined performance values. Always check the specifications before use.

TUV-certified Models (File No. R50030059)

Model	Coil ratings	Number of poles	Contact ratings	Certified number of operations
MY□	6 to 125 VDC 6 to 240 VDC	2	5 A, 250 VAC (cos φ = 1.0)	10,000 operations
		3	5 A, 250 VAC (cos φ = 1.0) 0.8 A, 250 VAC (cos φ = 0.4)	
		4	3 A, 120 VAC (cos φ = 1.0) 0.8 A, 120 VAC (cos φ = 0.4)	

UL-certified Models (File No. E41515)

Model	Coil ratings	Number of poles	Contact ratings	Certified number of operations	
MY	6 to 240 VAC 6 to 125 VDC	2	7A, 240 VAC (General Use)	6,000	
			7A, 24 VDC (Resistive)		
			5A, 240 VAC (General Use)		
			5A, 250 VAC (Resistive)		
			5A, 30 VDC (Resistive)		
			3A, 265 VAC (Resistive)		
			1/6HP, 250 VAC		1,000
			1/8HP, 265 VAC		
			1/10HP, 120 VAC		
			B300 Pilot Duty		
		3	5A, 28 VDC (Resistive)	6,000	
			5A, 240 VAC (General Use)	1,000	
			1/6 HP, 250 VAC		
		4	5A, 28 VDC (General Use) (Same polarity)	6,000	
			5A, 240 VAC (General Use) (Same polarity)		
			5A, 30 VDC (Resistive) (Same polarity)		
			5A, 250 VAC (Resistive) (Same polarity)		
			0.2A, 120 VDC (Resistive) (Same polarity)		
			1/6HP, 250 VAC (Same polarity)		1,000
			1/10HP, 120 VAC (Same polarity)		
B300 Pilot Duty (Same polarity)					

CSA-certified Models (File No. LR31928)

Model	Coil ratings	Number of poles	Contact ratings	Certified number of operations
MY	6 to 240 VAC 6 to 125 VDC	2	7A, 240 VAC (Resistive)	6,000
			7A, 24 VDC (Resistive)	
			5A, 240 VAC (General Use)	
			5A, 250 VAC (Resistive)	
			5A, 30 VDC (Resistive)	
			1/6HP, 250 VAC	
		1/10HP, 120 VAC		
		3	5A, 28 VDC (Resistive)	6,000
			7A, 240 VAC (General Use)	
			7A, 24 VDC (Resistive)	
			5A, 240 VAC (General Use)	
		4	1/6HP, 250 VAC	1,000
			7A, 240 VAC (General Use) (Same polarity)	6,000
			7A, 24 VDC (Resistive) (Same polarity)	
			5A, 240 VAC (General Use) (Same polarity)	
			5A, 30 VDC (Resistive)	
			5A, 250 VAC (Resistive) (Same polarity)	
			0.2A, 120 VDC (Resistive)	
1/6HP, 250 VAC	1,000			
1/10HP, 120 VAC				

- When ordering models that are certified for Lloyd's Register (LR) Standards, be sure to specify "LR-certified Model" with your order.

LR-certified Models (File No. 90/10270)

Model	Coil ratings	Number of poles	Contact ratings
MY□	6 to 240 VAC 6 to 125 VDC	2	2 A, 30 VDC inductive load 2 A, 200 VAC inductive load
		4	1.5 A, 30 VDC inductive load 0.8 A, 200 VAC inductive load 1.5 A, 115 VAC inductive load

Detailed Information on Models Certified for Safety Standards, MY2, MY4, MY4Z, and MY(S) Newly Released Models

• Refer to *Model Number Structure* on page 1 for a list of applicable models.

VDE-certified Models (Certificate No. 112467UG, EN 61810-1)

Model	Coil ratings	Number of poles	Contact ratings	Certified number of operations
MY□ (New model)	6, 12, 24, 48/50, 100/ 110, 110/120, 200/ 220, and 220/240 VAC 6, 12, 24, 48, 100/ 110, and 125 VDC	2	10 A, 250 VAC (cos φ = 1) 10 A, 30 VDC (L/R = 0 ms)	MY2: 10,000 operations MY4: 100,000 operations MY4Z: 50,000 operations (AC)
		4	5 A, 250 VAC (cos φ = 1) 5 A, 30 VDC (L/R = 0 ms)	

UL508-certified Models (File E41515)

Model	Coil ratings	Number of poles	Contact ratings	Certified number of operations
MY□ (New model)	6 to 240 VAC 6 to 125 VDC	2	10A, 250 VAC (General Use)	6,000
			10A, 30 VDC (General Use)	
			7A, 240 VAC (General Use)	
			7A, 24 VDC (Resistive)	
			5A, 240 VAC (General Use)	
			5A, 250 VAC (Resistive)	
			5A, 30 VDC (Resistive)	
			3A, 265 VAC (Resistive)	
			1/6HP, 250 VAC	
		1/8HP, 265 VAC		
		1/10HP, 120 VAC		
		B300 Pilot Duty (Same polarity)	6,000	
		4	5A, 28 VDC (General Use) (Same polarity)	6,000
			5A, 240 VAC (General Use) (Same polarity)	
			5A, 30 VDC (Resistive) (Same polarity)	
			5A, 250 VAC (Resistive) (Same polarity)	
			0.2A, 120 VDC (Resistive) (Same polarity)	
			1/6HP, 250 VAC (Same polarity)	1,000
1/10HP, 120 VAC (Same polarity)	6,000			
B300 Pilot Duty (Same polarity)	6,000			

CSA 22.2 No. 14-certified Models (File No. LR31928)

Model	Coil ratings	Number of poles	Contact ratings	Certified number of operations	
MY□ (New model)	6 to 240 VAC 6 to 125 VDC	2	7A, 240 VAC (General Use)	6,000	
			7A, 24 VDC (Resistive)		
			5A, 240 VAC (General Use)		
			5A, 250 VAC (Resistive)		
			5A, 30 VDC (Resistive)		
			3A, 265 VAC (Resistive)		
			1/6HP, 250 VAC		1,000
			1/8HP, 265 VAC		
			1/10HP, 120 VAC		
		B300 Pilot Duty (Same polarity)	6,000		
		4	5A, 240 VAC (General Use) (Same polarity)	6,000	
			5A, 28 VDC (General Use) (Same polarity)		
			5A, 250 VAC (Resistive) (Same polarity)		
			5A, 30 VDC (Resistive) (Same polarity)		
			0.2A, 120 VDC (Resistive) (Same polarity)		
			1/6HP, 250 VAC (Same polarity)	1,000	
			1/10HP, 120 VAC (Same polarity)	6,000	
		B300 Pilot Duty (Same polarity)	6,000		

LR-certified Models (File No. 98/10014)

Model	Coil ratings	Number of poles	Contact ratings	Certified number of operations
MY□ (New model)	6 to 240 VAC 6 to 125 VDC	2	10 A, 250 VAC (resistive) 2 A, 250 VAC (PF0.4) 10 A, 30 VDC (resistive) 2 A, 30 VDC (L/R = 7 ms)	MY2: 50,000 operations MY4: 50,000 operations
		4	5 A, 250 VAC (resistive) 0.8 A, 250 VAC (PF0.4) 5 A, 30 VDC (resistive) 1.5 A, 30 VDC (L/R = 7 ms)	

Miniature Power Relays: MY4Z-CBG

Ordering Information

When your order, specify the rated voltage.

Classification	Model	Rated voltage (V)	
		Standard products	Made-to-order items
Standard models	MY4Z-CBG	100/110 or 200/220 VAC	110/120 VAC
		24 or 100/110 VDC	12 or 48 VDC
Models with built-in operation indicators	MY4ZN-CBG	—	100/110 or 200/220 VAC
		—	24 VDC

Note: Ask your OMRON representative for details on the time required to deliver made-to-order products.

Ratings and Specifications

Ratings

Operating Coil

Item	Rated voltage (V)	Rated current (mA)		Coil resistance (Ω)	Coil inductance (H)		Must-operate voltage (V)	Must-release voltage (V)	Maximum voltage (V)	Power consumption (VA, W)
		50 Hz	60 Hz		Armature OFF	Armature ON				
AC	100/110	11.7/12.9	10/11	3,750	14.54	24.6	80% max.*1	30% min.*2	110% of rated voltage	Approx. 0.9 to 1.1 (at 60 Hz)
	110/120	9.9/10.8	8.4/9.2	4,430	19.2	32.1				
	200/220	6.2/6.8	5.3/5.8	12,950	54.75	94.07				
DC	12	75		160	0.73	1.37		10% min.*2		Approx. 0.9
	24	36.9		650	3.2	5.72				
	100/110	9.1/10		11,000	45.60	86.20				

Note: 1. The rated current and coil resistance are measured at a coil temperature of 23°C with tolerances of +15%/–20% for the AC rated current and \pm 15% for the DC coil resistance.
 2. The AC coil resistance and inductance values are reference values only.
 3. Operating characteristics were measured at a coil temperature of 23°C.
 4. The maximum voltage capacity was measured at an ambient temperature of 23°C.

*1. There is variation between products, but actual values are 80% max.

To ensure operation, apply at least 80% of the rated value

*2. There is variation between products, but actual values are 30% minimum for AC and 10% minimum for DC. To ensure release, use a value that is lower than the specified value.

Contact Ratings

Item	Load	Resistive load	Inductive load (cos ϕ = 0.4, L/R = 7 ms)
Rated load		1 A at 220 VAC 1 A at 24 VDC	0.3 A at 220 VAC 0.5 A at 24 VDC
Rated carry current		1 A	
Maximum contact voltage		250 VAC, 125 VDC	
Maximum contact current		1 A	1 A
Contact structure		Crossbar bifurcated	
Contact materials		Au cladding + AgPd	

Characteristics

Contact resistance*1	100 m Ω max.	
Operation time*2	20 ms max.	
Release time*2	20 ms max.	
Maximum operating frequency	Mechanical	18,000 operations/h
	Electrical	1,800 operations/h
Insulation resistance*3	100 M Ω	
Dielectric strength	Between coil and contacts	2,000 VAC at 50/60 Hz for 1 min.
	Between contacts of different polarity	
	Between contacts of the same polarity	700 VAC at 50/60 Hz for 1 min.
Vibration resistance	Destruction	10 to 55 to 10 Hz, 0.5-mm single amplitude (1.0-mm double amplitude)
	Malfunction	10 to 55 to 10 Hz, 0.5-mm single amplitude (1.0-mm double amplitude)
Shock resistance	Destruction	1,000 m/s ²
	Malfunction	200 m/s ²
Endurance	Mechanical	5,000,000 operations min. (operating frequency: 18,000 operations/hr)
	Electrical*4	50,000 operations min. (switching frequency: 1,800 operations/h) at rated load
Failure rate P value (reference value)*5	100 μ A at 1 VDC	
Ambient operating temperature	–25 to 70°C (with no icing or condensation)	
Ambient operating humidity	5% to 85%	
Weight	Approx. 35 g	

Note: The above values are initial values.

*1. Measurement conditions: 1 A at 5 VDC using the voltage drop method

*2. Measurement conditions: With rated operating power applied, not including contact bounce. Ambient temperature condition: 23°C

*3. Measurement conditions: For 500 VDC applied to the same location as for dielectric strength measurement.

*4. Ambient temperature condition: 23°C

*5. This value was measured at a switching frequency of 120 operations per minute.

Engineering Data

Engineering Data

Maximum Switching Capacity

MY4Z-CBG

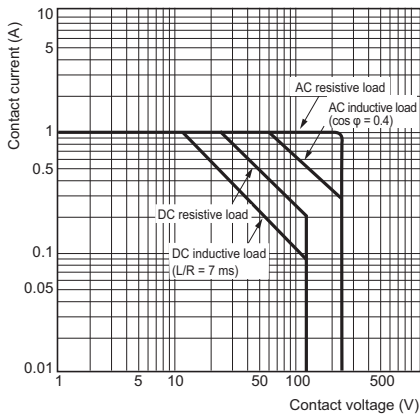

Contact Reliability Test (Modified Allen Bradley Circuit)

Contact load: 5 VDC, 1 mA resistive load
 Malfunction criteria level: Contact resistance of 100 Ω

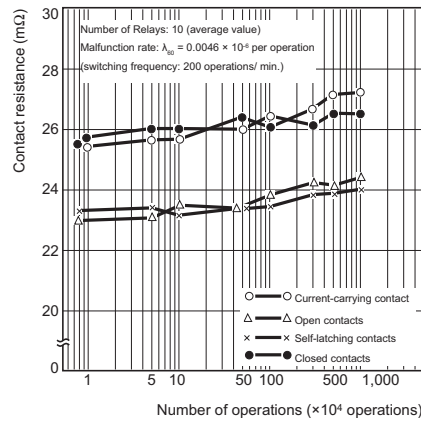

Dimensions

(Unit: mm)

MY4Z-CBG

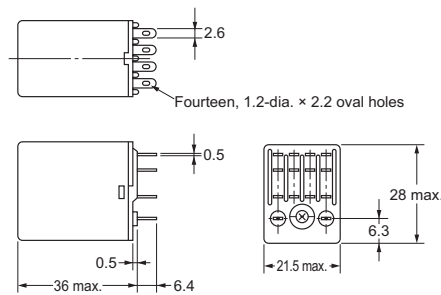
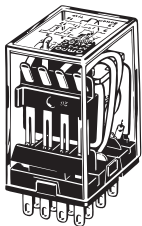

Terminal Arrangement/Internal Connections (Bottom View) Standard Models

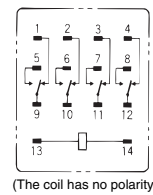

(The coil has no polarity.)

Safety Precautions

Refer to the *Common Relay Precautions*.

Applicable Sockets

Use only combinations of OMRON Relays and Sockets.

Plastic Sealed Relays: MYQ

Ordering Information

Relays with Plug-in or Soldered Terminals

When your order, specify the rated voltage.

Type		4 poles	
Classification		Model	Rated voltage (V)
Models with single contacts	Standard models	MYQ4	100/110, 110/120, 200/220, or 220/240 VAC 24 VDC
	Models with built-in operation indicators	MYQ4N	24, 100/110, 110/120, 200/220, or 220/240 VAC 12, 24, 48, or 100/110 VDC
Bifurcated contacts	Standard models	MYQ4Z	100/110, 110/120, or 200/220 VAC 12 or 24 VDC

Relays with PCB Terminals

Type		4 poles	
Classification		Model	Rated voltage (V)
Models with single contacts		MYQ4-02	50, 200/220, or 220/240 VAC 24 VDC
			100/110 VAC 24 or 48 VDC
Bifurcated contacts		MYQ4Z-02	100/110 VAC 24 or 48 VDC

Ratings and Specifications

Ratings Operating Coil

Rated voltage (V)	Item	Rated current (mA)		Coil resistance (Ω)	Coil inductance (H)		Must-operate voltage (V)	Must-release voltage (V)	Maximum voltage (V)	Power consumption (VA, W)
		50 Hz	60 Hz		Armature OFF	Armature ON				
AC	24	53.8	46	180	0.69	1.3	80% max.*1	30% min.*2	110% of rated voltage	Approx. 1.0 to 1.2 (at 60 Hz)
	100/110	11.7/12.9	10/11	3,750	14.54	24.6				
	110/120	9.9/10.8	8.4/9.2	4,430	19.2	32.1				
	200/220	6.2/6.8	5.3/5.8	12,950	54.75	91.07				
DC	220/240	4.8/5.3	4.2/4.6	18,790	83.5	136.4	80% max.*1	10% min.*2	110% of rated voltage	Approx. 0.9
	12	75	160	0.734	1.37					
	24	36.9	650	3.2	5.72					
	48	18.5	2,600	10.6	21.0					
100/110	9.1/10	11,000	45.6	86.0						

Note: 1. The rated current and coil resistance are measured at a coil temperature of 23°C with tolerances of +15%/–20% for AC rated current and ±15% for DC coil resistance.
 2. The AC coil resistance and coil inductance values are reference values only.
 3. Operating characteristics were measured at a coil temperature of 23°C.
 4. The maximum voltage capacity was measured at an ambient temperature of 23°C.

*1. There is variation between products, but actual values are 80% max.
 To ensure operation, apply at least 80% of the rated value

*2. There is variation between products, but actual values are 30% minimum for AC and 10% minimum for DC.
 To ensure release, use a value that is lower than the specified value.

Contact Ratings

Item	Type	Resistive load	Inductive load (cos φ = 0.4, L/R = 7 ms)
Rated load		1 A at 220 VAC, 1 A at 24 VDC	0.5 A at 220 VAC, 0.5 A at 24 VDC
Rated carry current		1 A	
Maximum contact voltage		250 VAC, 125 VDC	
Maximum contact current		1 A	
Maximum switching capacity (reference value)		220 VAC, 24 W	110 VAC, 12 W
Failure rate P value (reference value)		Single contacts: 1 mA at 1 VDC, Bifurcated contacts: 100 μA at 1 VDC	
Contact structure		Single/bifurcated	
Contact materials		Au plating + Ag	

* This value was measured at a switching frequency of 120 operations per minute.

Ambient operating temperature	–55 to 60° C*
Ambient operating humidity	5% to 85%

* With no icing or condensation.

Characteristics

Contact resistance*1		50 mΩ max.
Operation time*2		20 ms max.
Release time*2		20 ms max.
Maximum operating frequency	Mechanical	18,000 operations/h
	Rated load	1,800 operations/h
Dielectric strength	Between coil and contacts	1,500 VAC at 50/60 Hz for 1 min.
	Between contacts of different polarity	1,500 VAC at 50/60 Hz for 1 min.
	Between contacts of the same polarity	1,000 VAC at 50/60 Hz for 1 min.
Insulation resistance*3		100 MΩ min.
Vibration resistance	Destruction	10 to 55 to 10 Hz, 0.5-mm single amplitude (1.0-mm double amplitude)
	Malfunction	10 to 55 to 10 Hz, 0.5-mm single amplitude (1.0-mm double amplitude)
Shock resistance	Destruction	1,000 m/s ²
	Malfunction	200 m/s ²
Endurance	Mechanical	AC: 50,000,000 operations (5,000,000*4) min., DC: 100,000,000 operations (5,000,000*4) min. (switching frequency: 18,000 operations/h)
	Electrical*5	200,000 operations min. (100,000 operations*4) (rated load, switching frequency: 1,800 operations/h)
Weight		Approx. 35 g

Note: The values at the left are initial values.

*1. Measurement conditions: 1 A at 5 VDC using the voltage drop method

*2. Measurement conditions: With rated operating power applied, not including contact bounce. Ambient temperature condition: 23° C

*3. Measurement conditions: For 500 VDC applied to the same location as for dielectric strength measurement.

*4. This value is for bifurcated contacts.

*5. Ambient temperature condition: 23° C

Engineering Data

Engineering Data

Maximum Switching Capacity MYQ4(Z)

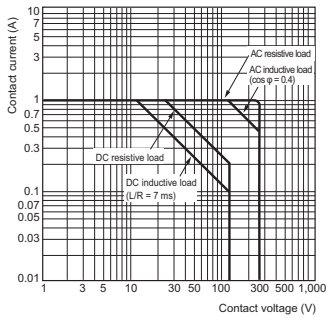

Endurance Curve MYQ4

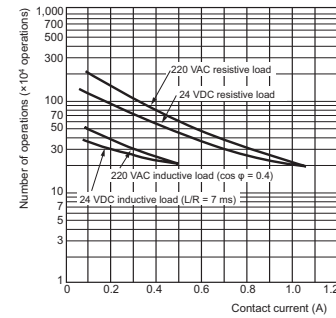

Note: The durability of bifurcated contacts is one-half that of single contacts.

H₂S Gas Data MYQ4

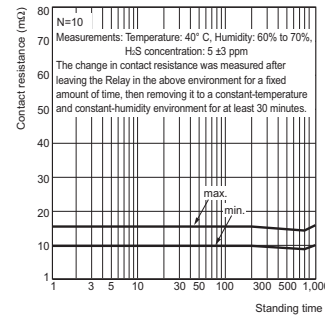

Malfunctioning Shock

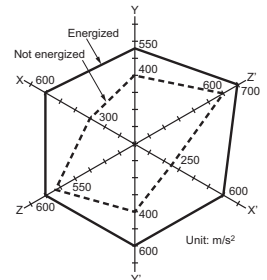

N = 20
 Measurement: Shock was applied 3 times each in 6 directions along 3 axes with the Relay energized and not energized to check the shock values that cause the Relay to malfunction.
 Criteria: Non-energized: 200 m/s²
 Energized: 200 m/s²

Shock direction

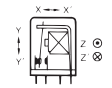

Dimensions

(Unit: mm)

Relays with Plug-in Terminals or Soldered Terminals MYQ4(Z)(N)

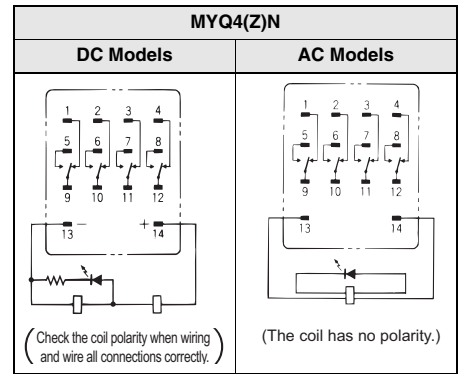
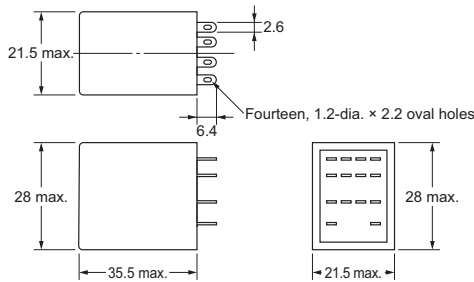
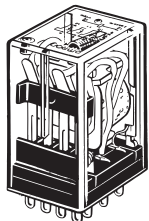

Note: 1. An AC model has coil disconnection self-diagnosis.
 2. For the DC models, check the coil polarity when wiring and wire all connections correctly.

Relays with PCB Terminals MYQ4(Z)-02

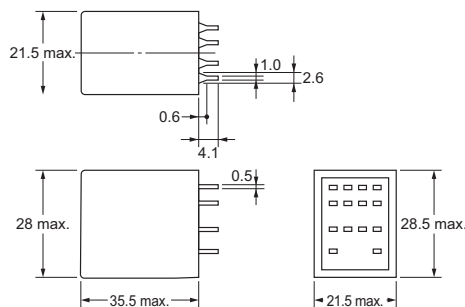
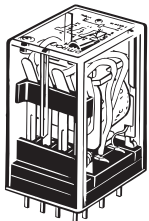

PCB Processing Dimensions (Bottom View)

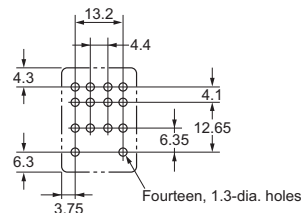

Note: The dimensional tolerance is ±0.1.

Terminal Arrangement/Internal Connections (Bottom View) Standard Models

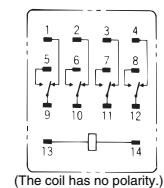

Safety Precautions

- For models with built-in operation indicators, check the coil polarity when wiring and wire all connections correctly (DC operation).
- Use only combinations of OMRON Relays and Sockets.
- The UL and CSA certifications for this model are the same as for the MY4-02.

Relay Replacement

To replace the Relay, turn OFF the power supply to the load and Relay coil sides to prevent unintended operation and possible electrical shock.

Latching Relays MYK

Ordering information

When your order, specify the rated voltage.

Relays with Plug-in or Soldered Terminals

Number of poles Classification	2 poles	
	Model	Rated voltage (V)
Standard models	MY2K	12 VAC
		24 VAC
		100 VAC
		100/110 VAC
		12 VDC
		24 VDC
		48 VDC

Relays with PCB Terminals

Number of poles Classification	2 poles	
	Model	Rated voltage (V)
Standard models	MY2K-02	24 VAC
		100 VAC
		12 VDC
		24 VDC

Ratings and Specifications

Ratings

Operating Coil

Item	Rated voltage (V)	Set coil			Reset coil			Set voltage (V)	Reset voltage (V)	Maximum voltage (V)	Power consumption (VA, W)	
		Rated current (mA)		Coil resistance (Ω)	Rated current (mA)		Coil resistance (Ω)				Set coil	Reset coil
		50 Hz	60 Hz		50 Hz	60 Hz						
AC	12	57	56	72	39	38.2	130	80% max.	80% max.	110% max. of rated voltage	Approx. 0.6 to 0.9 (at 60 Hz)	Approx. 0.2 to 0.5 (at 60 Hz)
	24	27.4	26.4	320	18.6	18.1	550					
	100	7.1	6.9	5,400	3.5	3.4	3,000					
DC	12	110		110	50		235					
	24	52		470	25		940					
	48	27		1,800	16		3,000					

- Note:
- The rated current for AC is the value measured with a DC ammeter in half-wave rectification.
 - The rated current and coil resistance are measured at a coil temperature of 23°C with tolerances of +15%/–20% for the AC rated current and ±15% for the DC coil resistance.
 - The AC coil resistance is a reference value only.
 - Operating characteristics were measured at a coil temperature of 23°C.
 - The maximum voltage capacity was measured at an ambient temperature of 23°C.

Contact Ratings

Item	Load	Resistive load	Inductive load (cos φ = 0.4, L/R = 7 ms)
Rated load		3 A at 220 VAC 3 A at 24 VDC	0.8 A at 220 VAC 1.5 A at 24 VDC
Rated carry current		3 A	
Maximum contact voltage		250 VAC, 125 VDC	
Maximum contact current		3 A	3 A
Contact structure		Single	
Contact materials		Au plating + Ag	

Ambient operating temperature	–55 to 60° C*
Ambient operating humidity	5% to 85%

* With no icing or condensation.

Characteristics

Contact resistance*1		50 mΩ max.
Set	Time*2	AC: 30 ms max., DC: 15 ms max.
	Minimum pulse width	AC: 60 ms, DC: 30 ms
Reset	Time*2	AC: 30 ms max., DC: 15 ms max.
	Minimum pulse width	AC: 60 ms, DC: 30 ms
Maximum operating frequency	Mechanical	18,000 operations/h
	Rated load	1,800 operations/h
Insulation resistance*3		100 MΩ
Dielectric strength	Between coil and contacts	1,500 VAC at 50/60 Hz for 1 min.
	Between contacts of different polarity	
	Between contacts of the same polarity	1,000 VAC at 50/60 Hz for 1 min.
Between set/reset coils		
Vibration resistance	Destruction	10 to 55 to 10 Hz, 0.5-mm single amplitude (1.0-mm double amplitude)
	Malfunction	10 to 55 to 10 Hz, 0.5-mm single amplitude (1.0-mm double amplitude)
Shock resistance	Destruction	1,000 m/s ²
	Malfunction	200 m/s ²
Endurance	Mechanical	100,000,000 operations min. (switching frequency: 18,000 operations/h)
	Electrical*4	200,000 operations min. (at 1,800 operations/hr, rated load)
Failure rate P value (reference value)*5		1 mA at 1 VDC
Weight		Approx. 30 g

- Note: The above values are initial values.
- *1. Measurement conditions: 1 A at 5 VDC using the voltage drop method
 - *2. Measurement conditions: With rated operating power applied, not including contact bounce.
 - *3. Measurement conditions: For 500 VDC applied to the same location as for dielectric strength measurement.
 - *4. Ambient temperature condition: 23° C
 - *5. This value was measured at a switching frequency of 120 operations per minute.

Engineering Data

Engineering Data

MY2K(-02)

Maximum Switching Capacity

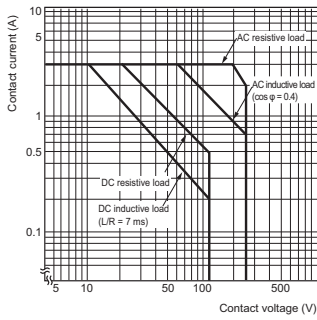

Endurance Curve

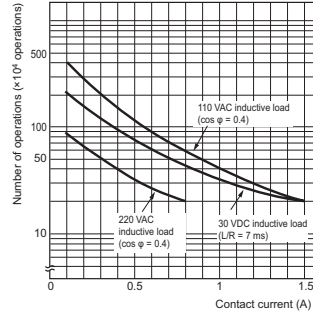
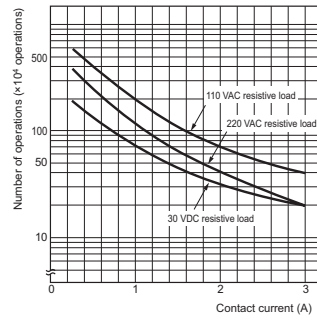

MY2K 100 VAC Malfunctioning Shock

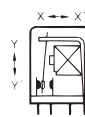
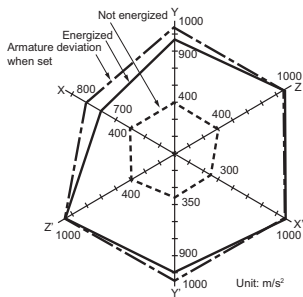

N = 20
 Measurement: Shock was applied 2 times each in 6 directions along 3 axes with the Relay energized and not energized to check the shock values that cause the Relay to malfunction.

Criteria: Non-energized: 200 m/s²
 Energized: 200 m/s²

MY2K 24 VDC Magnetic Interference (External Magnetic Field)

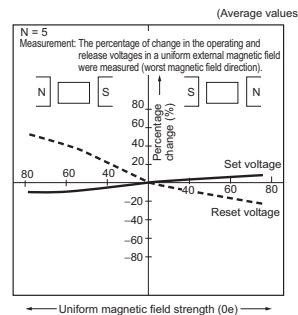

Latching Deterioration Over Time

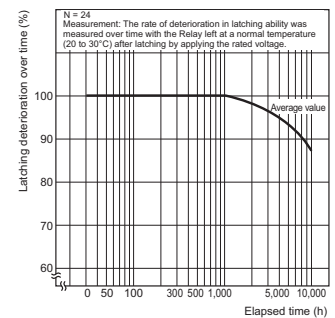

Dimensions

Relays with Plug-in Terminals or Soldered Terminals MY2K

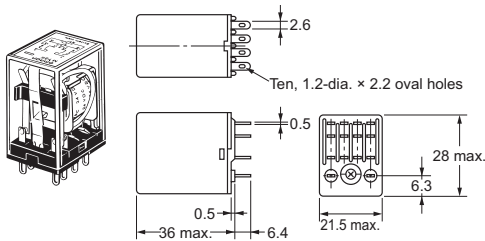

Terminal Arrangement/Internal Connections (Bottom View)

For AC

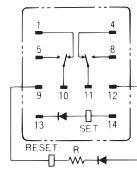

Note: R is a resistor for ampere-turn correction. This resistor is built-in to 50-VAC and higher models. (The coil has no polarity.)

For DC

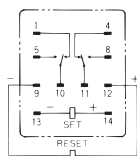

Note: Pay close attention to the set coil and reset coil polarities. If the connections are not correct, unintended operation may occur.

Safety Precautions

- For applications that use a 200 VAC power supply, connect external resistors Rs and Rr to a 100 VAC Relay.

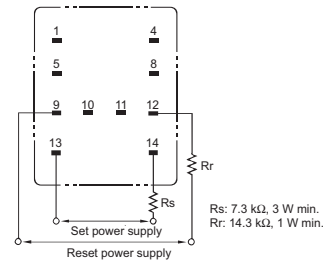

- Do not apply a voltage to the set and reset coils at the same time. If you apply the rated voltage to both coils simultaneously, the Relay will be set.
- The minimum pulse width in the performance column is the value for the following measurement conditions: an ambient temperature of 23° C with the rated operating voltage applied to the coil. The performance values given here may not be satisfied due to use over time and a reduction in latching performance due to changes in the ambient temperature or in the conditions of the application circuit.
- For actual use, apply the rated operating voltage with a pulse width based on the actual load and reset the Relay at least once per year to prevent degradation over time.
- If the Relay is used in an environment with strong magnetic fields, the surrounding magnetic field can demagnetize the magnetic body and cause unintended operation. Therefore, do not use these Relays in environments with strong magnetic fields.

Relay Replacement

To replace the Relay, turn OFF the power supply to the load and Relay coil sides to prevent unintended operation and possible electrical shock.

Applicable Sockets

Use only combinations of OMRON Relays and Sockets.

Relays with PCB Terminals MY2K-02

PCB Processing Dimensions (Bottom View)

Note: The dimensional tolerance is ±0.1.

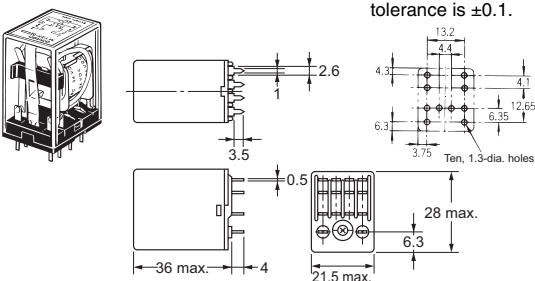

Hermetically Sealed Relays: MYH

Ordering Information When your order, specify the rated voltage.

Relays with Plug-in or Soldered Terminals

Type	4 poles	
	Model	Rated voltage (V)
Models with single contacts	MY4H	24, 100/110, or 110/120 VAC
		12, 24, 48, or 100/110 VDC
Bifurcated contacts	MY4ZH	24, 100/110, or 110/120 VAC
		12, 24, 48, or 100/110 VDC

Relays with PCB Terminals

Type	4 poles	
	Model	Rated voltage (V)
Models with single contacts	MY4H-0	110/120 VAC
		24 VDC
Bifurcated contacts	MY4ZH-0	24 or 100/110 VDC

Ratings and Specifications

Ratings

Operating Coil

Item	Rated voltage (V)	Rated current (mA)		Coil resistance (Ω)	Coil inductance (H)		Must-operate voltage (V)	Must-release voltage (V)	Maximum voltage (V)	Power consumption (VA, W)
		50 Hz	60 Hz		Armature OFF	Armature ON				
AC	24	53.8	46	180	0.69	1.3	80% max.*1	30% min.*2	110% of rated voltage	Approx. 1.0 to 1.2 (at 60 Hz)
	100/110	11.7/12.9	10/11	3,750	14.54	24.6				
	110/120	9.9/10.8	8.4/9.2	4,430	19.2	32.1				
DC	12	75		160	0.73	1.37	80% max.*1	10% min.*2	110% of rated voltage	Approx. 0.9
	24	36.9		650	3.2	5.72				
	48	18.5		2,600	10.6	21.0				
	100/110	9.1/10		11,000	45.6	86.2				

- Note:** 1. The rated current and coil resistance are measured at a coil temperature of 23°C with tolerances of +15%/–20% for the AC rated current and ±15% for the DC coil resistance.
 2. The AC coil resistance and inductance values are reference values only.
 3. Operating characteristics were measured at a coil temperature of 23°C.
 4. The maximum voltage capacity was measured at an ambient temperature of 23°C.

*1. There is variation between products, but actual values are 80% max.

To ensure operation, apply at least 80% of the rated value

*2. There is variation between products, but actual values are 30% minimum for AC and 10% minimum for DC. To ensure release, use a value that is lower than the specified value.

Contact Ratings

Item	Load	Models with single contacts		Bifurcated contacts	
		Resistive load	Inductive load cos φ = 0.4 L/R = 7 ms	Resistive load	Inductive load cos φ = 0.4 L/R = 7 ms
Rated load	3 A at 110 VAC 3 A at 24 VDC	0.8 A at 110 VAC 1.5 A at 24 VDC	3 A at 110 VAC 3 A at 24 VDC	0.8 A at 110 VAC 1.5 A at 24 VDC	
Rated carry current	3 A		3 A		
Maximum contact voltage	125 VAC 125 VDC		125 VAC 125 VDC		
Maximum contact current	3 A		3 A		
Contact structure	Single		Bifurcated		
Contact materials	Au plating + Ag				

Ambient operating temperature	–25 to 60° C*
Ambient operating humidity	5% to 85%

* With no icing or condensation.

Characteristics

Contact resistance*1	50 mΩ max.	
Operation time*2	20 ms max.	
Release time*2	20 ms max.	
Maximum operating frequency	Mechanical	18,000 operations/h
	Rated load	1,800 operations/h
Insulation resistance*4	100 MΩ min.	
Dielectric strength	Between coil and contacts	1,000 VAC at 50/60 Hz for 1 min. (700 VAC between contacts of the same polarity.)
	Between contacts of different polarity	
Vibration resistance	Destruction	10 to 55 to 10 Hz, 0.5-mm single amplitude (1.0-mm double amplitude)
	Malfunction	10 to 55 to 10 Hz, 0.5-mm single amplitude (1.0-mm double amplitude)
Shock resistance	Destruction	1,000 m/s ²
	Malfunction	200 m/s ²
Endurance	Mechanical	50,000,000 operations (5,000,000 operations*4) min. (operating frequency: 18,000 operations/h)
	Electrical*5	100,000 operations (50,000 operations*4) min. rated load, switching frequency: 1,800 operations/h
Failure rate P value (reference value)*6	Single contacts: 100 μA at 1 VDC Bifurcated contacts: 100 μA at 100 mVDC	
Weight	Approx. 50 g	

Note: The above values are initial values.

*1. Measurement conditions: 1 A at 5 VDC using the voltage drop method

*2. Measurement conditions: With rated operating power applied, not including contact bounce.
Ambient temperature condition: 23° C

*3. Measurement conditions: For 500 VDC applied to the same location as for dielectric strength measurement.

*4. This value is for bifurcated contacts.

*5. Ambient temperature condition: 23° C

*6. This value was measured at a switching frequency of 120 operations per minute.

Engineering Data

Engineering Data

Maximum Switching Capacity MY4(Z)H

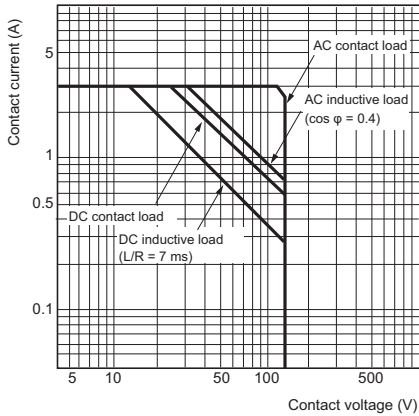

Endurance Curve MY4H

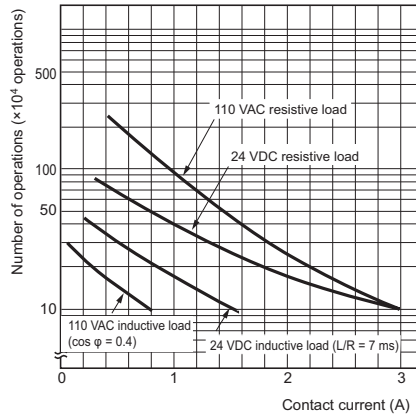

Note: The durability of bifurcated contacts is one-half that of single contacts.

Dimensions

(Unit: mm)

Relays with Plug-in Terminals or Soldered Terminals MY4(Z)H

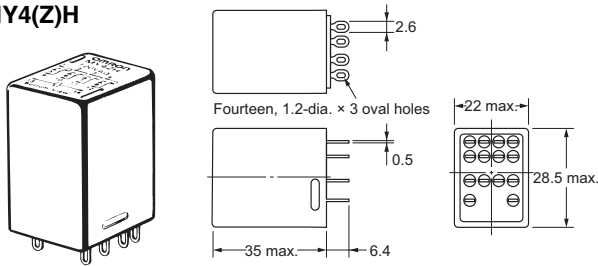

Terminal Arrangement/ Internal Connections (Bottom View)

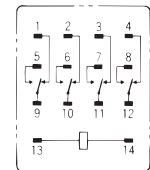

(The coil has no polarity.)

Relays with PCB Terminals MY4(Z)H-0

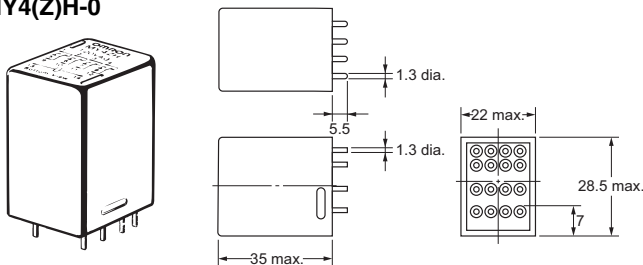

PCB Processing Dimensions (Bottom View)

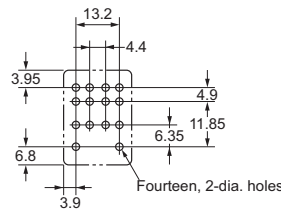

Safety Precautions

PCB Design for Hermetically Sealed Relays

When a Relay with PCB Terminals is mounted, a short-circuit can occur depending on the design of the PCB pattern because the Relay itself is made out of metal.

Solution

Refer to the external dimensions of the Relay and design the PCB pattern with enough space to prevent this problem.

Applicable Sockets

Use only combinations of OMRON Relays and Sockets.

Application Environment for Hermetically Sealed Relays

Humid environments can cause insulation problems, which may result in short-circuiting or unintended operation.

Solution

Do not use these Relays in an environment where the Relay will come into contact with water vapor, condensation, or water droplets. This can reduce the surface tension of the insulating beads and cause short-circuiting or unintended operation due to poor insulation.

Relay Replacement

To replace the Relay, turn OFF the power supply to the load and Relay coil sides to prevent unintended operation and possible electrical shock.

Options (Order Separately) Connection Socket and Mounting Bracket Selection Table

Type	Front-mounting Sockets				Back-mounting Sockets						
	Track or screw mounting		Screw mounting only	Screwless Socket	Solder terminals		Wrapping terminals				Relays with PCB Terminals
	---	Terminal cover structure	---		Without Mounting Brackets	With Mounting Brackets	Without Mounting Brackets		With Mounting Brackets		
Model	Screw terminal size: M3		Screw terminal size: M3.5	Without Mounting Brackets	With Mounting Brackets	Terminal length: 25 mm	Terminal length: 20 mm	Terminal length: 25 mm	Terminal length: 20 mm		
MY2□ MY2(S)	PYF08A (PYC-A1)	PYF08A-E (PYC-A1)	PYF08M (PYC-P)	PYF08S	PY08 (PYC-P)	PY08-Y1	PY08QN (PYC-P)	PY08QN2 (PYC-P)	PY08QN-Y1	PY08QN2-Y1	PY08-02 (PYC-P)
MY2Z□-CR	PYF08A (Y92H-3)	PYF08A-E (Y92H-3)			PY08 (PYC-1)	PY08-Y3	PY08QN (PYC-1)	PY08QN2 (PYC-1)			PY08-02 (PYC-1)
MY3□	PYF11A (PYC-A1)				PY11 (PYC-P)	PY11-Y1	PY11QN (PYC-P)	PY11QN2 (PYC-P)	PY11QN-Y1	PY11QN2-Y1	PY11-02 (PYC-P)
MY4□ MY4(S) MY4Z□ MY4Z-CBG MYQ4□ MY4H MY4ZH MY2K□	Screw terminal size: M3			PYF14S	PY14 (PYC-P)	PY14-Y1	PY14QN (PYC-P)	PY14QN2 (PYC-P)	PY14QN-Y1	PY14QN2-Y1	PY14-02 (PYC-P)
	PYF14A (PYC-A1)										
	Screw terminal size: M3.5	PYF14A-E (PYC-A1)									
	PYF14T (PYC-A1)										

- Note:**
- The information in parentheses is the model number of the applicable Mounting Bracket. Mounting Brackets are sold in sets of two. However, the PYC-P is just one Mounting Bracket.
 - The PYF□A-E has a terminal cover with finger protection. Round terminals cannot be used. Use forked terminals or ferrules instead.
 - Refer to *Common Socket and DIN Track Products* for the external dimensions of the Socket Relays.
 - The Mounting Brackets are applicable for Relays with a height of 36 mm or less. If the Relay height is greater than 53 mm, use Y92H-3 for the Front-mounting Socket and PYC-1 for the Back-mounting Socket. (The Y92H-3 is a set of two Brackets and the PYC-1 is just one Bracket.)
 - Refer to *PYF□□S/P2RF-□-S* for details on Screwless Sockets.
 - The terminal cover is integrated into the Socket.
 - If an MY□(S) Relay with a Latching Lever is used in combination with a PY□□-02 Socket for Relays with PCB Terminals and a PYC-P Mounting Brackets, the lever will not operate.
 - We recommend using the PYC-E1 Mounting Bracket for a MY2(S) Relay with Latching Lever. (If the PYC-A1 is used with the MY2(S), the latching lever will be blocked by the Mounting Bracket and the lever will not operate.)

Mounting Heights with Sockets (Unit: mm)

Front-mounting Sockets

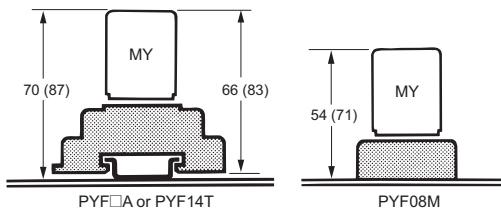

Back-mounting Sockets

Screwless Sockets

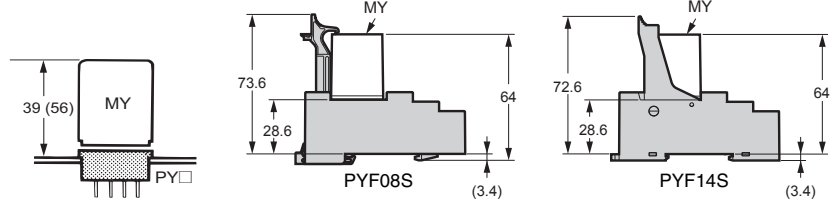

- Note:**
- The PYF□A can be mounted on a track or with screws.
 - The heights given in parentheses are the measurements for 53-mm-high Relays.
 - Use the PYC-P Mounting Bracket for the PYF08M.

Socket Mounting Plate (t = 1.6) (Unit: mm)

Use a Socket Mounting Plate to mount multiple connection Sockets in a row.

Item	Applicable Sockets	Type	For mounting 1 Socket	For mounting 8 Sockets	For mounting 36 Sockets
Without protective bracket	PY08, PY08QN(2), PY11, PY11QN(2), PY14, and PY14QN(2)	PYP-1	PYP-1	PYP-18	PYP-36
With protective bracket	PY08-Y1, PY08QN(2)-Y1, PY11-Y1, PY11QN(2)-Y1, PY14-Y1, and PY14QN(2)-Y1				

Note: You can cut the PYP-18 and PYP-36 to any required length.

PYP-1

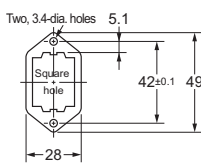

PYP-18

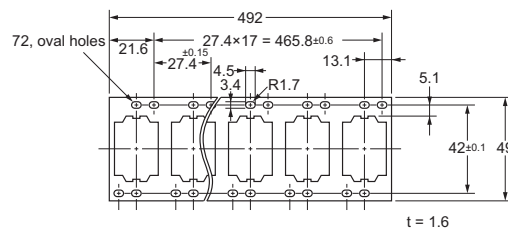

PYP-36

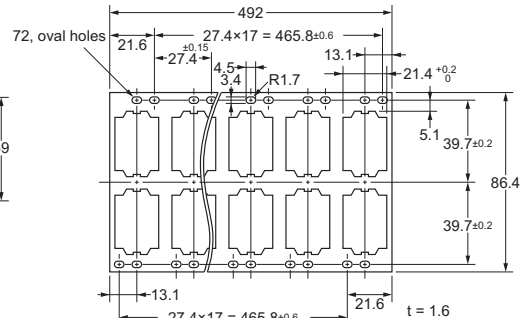

The minimum order for the PYP-1 is 10 pieces.

Compliance with Electrical Appliances and Material Safety Act

- All standard models comply with the Electrical Appliances and Material Safety Act.
- Always protect any exposed terminals (including Socket terminals) after wiring with insulation tubes or resin coating on PCBs.

Model	Number of poles	Coil ratings	Contact ratings
MY	1 2 3	6 to 220 VAC 6 to 120 VDC	5 A, 200 VAC
	4 *	6 to 110 VAC 6 to 120 VDC	3 A, 115 VAC

* Under the Electrical Appliances and Material Safety Act, do not use any 4-pole models with a voltage that exceeds 150 VAC. However, this restriction can be ignored if compliance with the Electrical Appliances and Material Safety Act is not required.

Safety Precautions

Refer to the *Common Relay Precautions*.

Precautions for Correct Use

Handling

For models with a built-in operation indicator, models with a built-in diode, or high-sensitivity models, check the coil polarity when wiring and wire all connections correctly (DC operation).

Installation

- There is no specifically required installation orientation, but make sure that the Relays are installed so that the contacts are not subjected to vibration or shock in their movement direction.

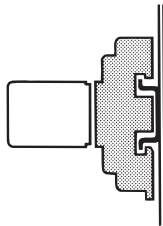

- Use two M3 screws to attach case-surface-mounted models (MY□F) and tighten the screws securely (tightening torque: 0.98 N•m).

Using MY-series Relays with Microloads with Infrequent Operation

If any standard MY-series Relays (e.g., MY4) are used infrequently to switch microloads, the contacts may become unstable and eventually result in poor contact. In this case, we recommend using the MY4Z-CBG Series, which has high contact reliability for microloads (Refer to page 25.)

About the Built-in Diode and CR Elements

The diode or CR element that are built into the Relay are designed to absorb the reverse voltage from the Relay coil. If a large surge in voltage is applied to the diode or CR element from an external source, the element will be destroyed. If there is the possibility of large voltage surges that could be applied to the elements from an external source, take any necessary surge absorption measures.

Latching Levers

- Turn OFF the power supply when operating the latching lever. After you use the latching lever always return it to its original state.
- Do not use the latching lever as a switch.
- The latching lever can be used for 100 operations min.

Relay Replacement

To replace the Relay, turn OFF the power supply to the load and Relay coil sides to prevent unintended operation and possible electrical shock.

Attaching and Removing Relay Hold-down Clips

When you attach a Hold-down Clip to or remove it from a Socket, wear gloves or take other measures to prevent injuring your fingers on the Hold-down Clip.

Terms and Conditions Agreement

Read and understand this catalog.

Please read and understand this catalog before purchasing the products. Please consult your OMRON representative if you have any questions or comments.

Warranties.

(a) Exclusive Warranty. Omron's exclusive warranty is that the Products will be free from defects in materials and workmanship for a period of twelve months from the date of sale by Omron (or such other period expressed in writing by Omron). Omron disclaims all other warranties, express or implied.

(b) Limitations. OMRON MAKES NO WARRANTY OR REPRESENTATION, EXPRESS OR IMPLIED, ABOUT NON-INFRINGEMENT, MERCHANTABILITY OR FITNESS FOR A PARTICULAR PURPOSE OF THE PRODUCTS. BUYER ACKNOWLEDGES THAT IT ALONE HAS DETERMINED THAT THE PRODUCTS WILL SUITABLY MEET THE REQUIREMENTS OF THEIR INTENDED USE.

Omron further disclaims all warranties and responsibility of any type for claims or expenses based on infringement by the Products or otherwise of any intellectual property right. (c) Buyer Remedy. Omron's sole obligation hereunder shall be, at Omron's election, to (i) replace (in the form originally shipped with Buyer responsible for labor charges for removal or replacement thereof) the non-complying Product, (ii) repair the non-complying Product, or (iii) repay or credit Buyer an amount equal to the purchase price of the non-complying Product; provided that in no event shall Omron be responsible for warranty, repair, indemnity or any other claims or expenses regarding the Products unless Omron's analysis confirms that the Products were properly handled, stored, installed and maintained and not subject to contamination, abuse, misuse or inappropriate modification. Return of any Products by Buyer must be approved in writing by Omron before shipment. Omron Companies shall not be liable for the suitability or unsuitability or the results from the use of Products in combination with any electrical or electronic components, circuits, system assemblies or any other materials or substances or environments. Any advice, recommendations or information given orally or in writing, are not to be construed as an amendment or addition to the above warranty.

See <http://www.omron.com/global/> or contact your Omron representative for published information.

Limitation on Liability; Etc.

OMRON COMPANIES SHALL NOT BE LIABLE FOR SPECIAL, INDIRECT, INCIDENTAL, OR CONSEQUENTIAL DAMAGES, LOSS OF PROFITS OR PRODUCTION OR COMMERCIAL LOSS IN ANY WAY CONNECTED WITH THE PRODUCTS, WHETHER SUCH CLAIM IS BASED IN CONTRACT, WARRANTY, NEGLIGENCE OR STRICT LIABILITY.

Further, in no event shall liability of Omron Companies exceed the individual price of the Product on which liability is asserted.

Suitability of Use.

Omron Companies shall not be responsible for conformity with any standards, codes or regulations which apply to the combination of the Product in the Buyer's application or use of the Product. At Buyer's request, Omron will provide applicable third party certification documents identifying ratings and limitations of use which apply to the Product. This information by itself is not sufficient for a complete determination of the suitability of the Product in combination with the end product, machine, system, or other application or use. Buyer shall be solely responsible for determining appropriateness of the particular Product with respect to Buyer's application, product or system. Buyer shall take application responsibility in all cases.

NEVER USE THE PRODUCT FOR AN APPLICATION INVOLVING SERIOUS RISK TO LIFE OR PROPERTY OR IN LARGE QUANTITIES WITHOUT ENSURING THAT THE SYSTEM AS A WHOLE HAS BEEN DESIGNED TO ADDRESS THE RISKS, AND THAT THE OMRON PRODUCT(S) IS PROPERLY RATED AND INSTALLED FOR THE INTENDED USE WITHIN THE OVERALL EQUIPMENT OR SYSTEM.

Programmable Products.

Omron Companies shall not be responsible for the user's programming of a programmable Product, or any consequence thereof.

Performance Data.

Data presented in Omron Company websites, catalogs and other materials is provided as a guide for the user in determining suitability and does not constitute a warranty. It may represent the result of Omron's test conditions, and the user must correlate it to actual application requirements. Actual performance is subject to the Omron's Warranty and Limitations of Liability.

Change in Specifications.

Product specifications and accessories may be changed at any time based on improvements and other reasons. It is our practice to change part numbers when published ratings or features are changed, or when significant construction changes are made. However, some specifications of the Product may be changed without any notice. When in doubt, special part numbers may be assigned to fix or establish key specifications for your application. Please consult with your Omron's representative at any time to confirm actual specifications of purchased Product.

Errors and Omissions.

Information presented by Omron Companies has been checked and is believed to be accurate; however, no responsibility is assumed for clerical, typographical or proofreading errors or omissions.

2016.1

In the interest of product improvement, specifications are subject to change without notice.

OMRON Corporation
Industrial Automation Company

<http://www.ia.omron.com/>

(c)Copyright OMRON Corporation 2016 All Right Reserved.

X-ON Electronics

Largest Supplier of Electrical and Electronic Components

Click to view similar products for [General Purpose Relays](#) category:

Click to view products by [Omron](#) manufacturer:

Other Similar products are found below :

[PCN-105D3MH,000](#) [59641F200](#) [5JO-1000CD-SIL](#) [LY1SAC110120](#) [5X827E](#) [5X837F](#) [5X840F](#) [5X842F](#) [5X848E](#) [LY2N-AC120](#) [LY2S-AC220/240](#) [LY2-US-AC120](#) [LY3-US-AC120](#) [LY4F-UA-DC12](#) [LY4F-UA-DC24](#) [LY4F-US-AC120](#) [LY4F-US-AC240](#) [LY4F-US-DC24](#) [LY4F-VD-AC110](#) [LYQ20DC12](#) [M115C60](#) [M115N010](#) [M115N0150](#) [6031007G](#) [603-12D](#) [61211T0B4](#) [61212T400](#) [61222Q400](#) [61243B600](#) [61243C500](#) [61243Q400](#) [61311BOA2](#) [61311BOA6](#) [61311BOA8](#) [61311C0A2](#) [61311COA1](#) [61311COA6](#) [61311F0A2](#) [61311QOA1](#) [61311QOA4](#) [61311T0D6](#) [61311TOA6](#) [61311TOA7](#) [61311TOB3](#) [61311TOB4](#) [61311U0A6](#) [61312Q600](#) [61312T400](#) [61312T600](#) [61313U200](#)