

Mechanical Indicators Added as a Standard Feature to Our Best-selling MY General-purpose Relays



- A lineup of models with latching levers added for easier circuit checking.
- Reduces wiring work by 60% when combined with the PYF-PU Push-In Plus Socket (according to actual OMRON measurements).
- Relays with AC and DC coils have different colors of operating indicators (LEDs).
- Printing on the coil tape indicates the operating coil specification.
- Mechanical operation indicators are a standard feature on all models.
- RoHS compliant.
- UL, CSA, IEC (VDE certification), and CQC.

Refer to the *Common Relay Precautions*.

Features

Common to all specifications

- Mechanical indicators are a standard feature on all models so that you can easily check the contact status.
- The color of the LED shows whether the coil voltage is AC or DC.

Mechanical indicators
(one on left and one on right)

Contacts ON (coil energized)

Contacts OFF (coil de-energized)

LED operation indicator
Relay with AC coil: Red
Relay with DC coil: Green



Relay with AC Coil (LED: Red)

Relay with AC Coil (LED: Red)

Relay with DC Coil (LED: Green)

With latching lever

- Useful for the operation check of relay sequence circuits.
- The coil voltage AC/DC can be identified by the color of the latching lever (AC coil specification: red, DC coil specification: Blue).

Latching lever operating method

	Normal State	Mode 1: Momentary State	Mode 2: Locked State
When seen from the top			
When seen from the side			
Operation Description	---	Slide the lever one step and press the yellow button with an insulated tool to operate the contacts.	If you slide the lever two steps, the contacts lock in the operation position.

Model Number Structure

Model Number Legend

MY □ □ □ - □ □ -GS DC24
 1 2 3 4 5

1. Number of Poles
 2: 2 poles
 4: 4 poles
2. Latching Lever
 Blank: Without latching lever
 I: With latching lever
3. LED Operation Indicator
 Blank: Built-in mechanical indicators
 N: LED operation indicator and built-in mechanical indicators
4. Coil Surge Absorption
 Blank: Standard models
 D2: Models with built-in diodes
 CR: Models with built-in CR circuits
5. Operating Coil Voltage
 Display Example: DC24

List of Models

Miniature Power Relays (MY-GS)

Category	Number of poles	Contact structure	Plug-in (octal pins) terminals		
				With operation indicator	
				With latching lever	
Standard models	2	Single	MY2-GS	MY2N-GS	MY2IN-GS
	4		MY4-GS	MY4N-GS	MY4IN-GS
Models with built-in diodes for coil surge absorption	2		---	MY2N-D2-GS	MY2IN-D2-GS
	4		---	MY4N-D2-GS	MY4IN-D2-GS
Models with built-in CR circuits for coil surge absorption	2		---	MY2N-CR-GS	MY2IN-CR-GS
	4		---	MY4N-CR-GS	MY4IN-CR-GS

Ordering Information

Main unit

Standard model without operation indicator

Number of poles	Model	Rated voltage (V)
2	MY2-GS	12, 24, 48, 100/110, 110/120, 200/220, 220/240 VAC 6, 12, 24, 48, 100/110 VDC
4	MY4-GS	12, 24, 48, 100/110, 110/120, 200/220, 220/240 VAC 6, 12, 24, 48, 100/110 VDC

Standard model with operation indicator

Number of poles	Model	Rated voltage (V)
2	MY2N-GS	12, 24, 48, 100/110, 110/120, 200/220, 220/240 VAC 6, 12, 24, 48, 100/110, 220 VDC
4	MY4N-GS	12, 24, 48, 100/110, 110/120, 200/220, 220/240 VAC 6, 12, 24, 48, 100/110, 220 VDC

Standard model with operation indicator and latching lever

Number of poles	Model	Rated voltage (V)
2	MY2IN-GS	12, 24, 48, 100/110, 110/120, 200/220, 220/240 VAC 6, 12, 24, 48, 100/110, 220 VDC
4	MY4IN-GS	12, 24, 48, 100/110, 110/120, 200/220, 220/240 VAC 6, 12, 24, 48, 100/110, 220 VDC

Models with built-in diodes for coil surge absorption with operation indicator

Number of poles	Model	Rated voltage (V)
2	MY2N-D2-GS	12, 24, 48, 100/110, 220 VDC
4	MY4N-D2-GS	12, 24, 48, 100/110, 220 VDC

Models with built-in diodes for coil surge absorption with operation indicator and latching lever

Number of poles	Model	Rated voltage (V)
2	MY2IN-D2-GS	12, 24, 48, 100/110, 220 VDC
4	MY4IN-D2-GS	12, 24, 48, 100/110, 220 VDC

Models with built-in CR circuits for coil surge absorption with operation indicator







Number of poles	Model	Rated voltage (V)
2	MY2N-CR-GS	100/110, 110/120, 200/220, 220/240 VAC
4	MY4N-CR-GS	100/110, 110/120, 200/220, 220/240 VAC

Models with built-in CR circuits for coil surge absorption with operation indicator and latching lever

Number of poles	Model	Rated voltage (V)
2	MY2IN-CR-GS	100/110, 110/120, 200/220, 220/240 VAC
4	MY4IN-CR-GS	100/110, 110/120, 200/220, 220/240 VAC

Options (order separately)

Front-mounting Sockets



Number of Pins	Applicable Relay Model	Terminal Type	Mounting Method	Appearance	Model	Hold-down Clips
8	MY2-GS MY2N-GS MY2IN-GS MY2N-D2-GS MY2IN-CR-GS MY2IN-CR-GS	Screw terminal Finger protection structure *1 (Screw size M3)	DIN Track or screw mounting		PYFZ-08-E	PYC-A1 *3
		Screw terminal Finger protection structure *1 (Screw size M3)	DIN Track or screw mounting		PYF08A-N	PYC-A1* 3
		Push-In Plus Terminal (Integrated Socket with release lever)	DIN Track or screw mounting *2		PYF-08-PU	---
14	MY4-GS MY4N-GS MY4IN-GS MY4N-D2-GS MY4IN-D2-GS MY4N-CR-GS MY4IN-CR-GS	Screw terminal Finger protection structure *1 (Screw size M3)	DIN Track or screw mounting		PYFZ-14-E	PYC-A1 *3
		Screw terminal Finger protection structure *1 (Screw size M3)	DIN Track or screw mounting		PYF14A-N	PYC-A1 *3
		Push-In Plus Terminal (Integrated Socket with release lever)	DIN Track or screw mounting *2		PYF-14-PU	---

*1. In the finger protection type (PYFZ-□-E, and PYF□A-N), the terminal cover is integrated into the Socket. Round terminals cannot be used. Use forked terminals or ferrules instead.



*2. There are screw mounting holes in the DIN hooks on the PYF-□□-PU. Pull out the DIN hook tabs to mount the Sockets with screws.

*3. Model number of the applicable Mounting Bracket. Sold in sets of two.

Back-mounting Sockets

Number of Pins	Applicable Relay Model	Terminal Type	Appearance	Model	Hold-down Clips
8	PY08-02	PCB terminals		PY08-02	PYC-P
14	PY14-02	PCB terminals		PY14-02	

Socket accessories
Mounting Bracket

Appearance *1	Model	Weight *2	Application
	PYC-A1	Approx. 0.54 g	For joining the Socket and Relay
	PYC-P	Approx. 1.4 g	For joining the Socket and Relay

*1. Describes the appearance when the Relay, Socket, and Mounting Bracket have been combined together.

*2. The PYC-A1 includes two Mounting Brackets in one set. The weight specified above is the weight of one Mounting Bracket.

Ratings and Specifications

Ratings

Main unit

Operating Coil

Item	Rated current (mA)		Coil resistance (Ω)	Coil inductance (H)		Must-operate voltage	Must-release voltage	Maximum voltage	Power consumption (VA, W)
	50 Hz	60 Hz		Armature OFF	Armature ON				
AC	12	106.5	91	46	0.17	0.33	30% min. *2	110%	Approx. 0.9 to 1.3 (at 60 Hz)
	24	53.8	46	180	0.69	1.3			
	48	25.7	21.1	788	3.22	5.66			
	100/110	11.7/12.9	10.0/11.0	3,750	14.54	24.6			
	110/120	9.9/10.8	8.4/9.2	4,430	19.2	32.1			
	200/220	6.2/6.8	5.3/5.8	12,950	54.75	94.07			
	220/240	5.2/6.2	4.3/5.0	15,920	83.5	136.4			
DC	6	146 (151)		41.0 (39.8)	0.17	0.33	10% min. *2	110%	Approx. 0.9
	12	72.7 (75)		165 (160)	0.73	1.37			
	24	36.3 (37.7)		662 (636)	3.2	5.72			
	48	17.6 (18.8)		2,725 (2,560)	10.6	21.0			
	100/110	8.7 (9.0)/9.6 (9.9)		11,440 (11,100)	45.6	86.2			
	220	3.6		60,394	362.3	452.9			Approx. 0.8

- Note:**
- The rated current and coil resistance are measured at a coil temperature of 23°C with tolerances of +15%/-20% for the AC rated current and +15% for the DC coil resistance.
 - The AC coil resistance and inductance values are reference values only (at 60 Hz).
 - Operating characteristics were measured at a coil temperature of 23°C.
 - The values in parentheses for the rated currents and coil voltages of DC coils are for models with LED operation indicators.
 - The maximum voltage capacity was measured at an ambient temperature of 23°C.

*1. There is variation between products, but actual values are 80% max.

The Relay will operate if 80% or higher of the rated voltage is applied. However, to achieve the specified characteristics, apply the rated voltage to the coil.

*2. There is variation between products, but actual values are 30% minimum for AC and 10% minimum for DC. To ensure release, use a value that is lower than the specified value.

Contacts

	2 poles			4 poles		
	Resistive load	Inductive load (cos φ = 0.4, L/R = 7 ms)		Resistive load	Inductive load (cos φ = 0.4, L/R = 7 ms)	
Contact configuration	DPDT			4PDT		
Contact structure	Single					
Contact material	Ag					
Rated load	7 A at 250 VAC 7 A at 30 VDC	5 A at 220 VAC 5 A at 24 VDC	2 A at 220 VAC 2 A at 24 VDC	6 A at 250 VAC 6 A at 30 VDC	3 A at 220 VAC 3 A at 24 VDC	0.8 A at 220 VAC 1.5 A at 24 VDC
Electrical endurance *1	120,000 operations	500,000 operations		30,000 operations	200,000 operations	
Rated carry current *2	7 A			6 A		
Maximum contact voltage	250 VAC, 220 VDC			250 VAC, 220 VDC		
Maximum contact current *2	7 A			6 A		
Maximum switching capacity	1,750 VA 210 W		440 VA 48 W	1,500 VA 180 W		176 VA 36 W
Minimum load (reference values) *3	1 mA at 5 VDC					

*1. Rated load, switching frequency: 2,400 operations/h. Ambient temperature condition: 23°C. Duty ratio: 33%.

*2. 2 poles of 7 A is for an ambient temperature of 40°C. At an ambient temperature of 70°C, the value is 5 A.

4 poles of 6 A is for an ambient temperature of 50°C. At an ambient temperature of 70°C, the value is 3 A.

*3. These values are guides for the switchable limits for minute load levels, such as in electronic circuits. Actual characteristics may be different. These values will depend on the switching frequency, atmosphere, and expected reliability level. Confirm applicability in the actual system under actual application conditions.

Characteristics

Main unit

		2 poles	4 poles
Contact resistance *1		100 mΩ max.	
Operation time *2		20 ms max.	
Release time *2		20 ms max.	
Maximum operating frequency	Mechanical	18,000 operations/h	
	Rated load	2,400 operations/h	
Insulation resistance *3		1,000 MΩ min.	
Dielectric strength	Between coil and contacts	2,000 VAC at 50/60 Hz for 1 min.	
	Between contacts of different polarity	2,000 VAC at 50/60 Hz for 1 min.	
	Between contacts of the same polarity	1,000 VAC at 50/60 Hz for 1 min.	
Vibration resistance	Destruction	10 to 55 to 10 Hz, Double amplitude: 1.0 mm	
	Malfunction	10 to 55 to 10 Hz, Double amplitude: 1.0 mm	
Shock resistance	Destruction	1,000 m/s ² (approx. 100 G)	
	Malfunction	200 m/s ² (Approx. 20 G)	
Mechanical endurance		50,000,000 operations (switching frequency: 18,000 operations/h)	
Ambient operating temperature		Standard models: -55 to 70°C (with no icing or condensation) Models with LED operation indicators: -40 to 70°C (with no icing or condensation)	
Ambient humidity		5% to 85%	
Weight		Approx. 35 g	

Note: The above values are initial values.

*1. Measurement conditions: 1 A at 5 VDC using the voltage drop method.

*2. Measurement conditions: With rated operating power applied, not including contact bounce time.

*3. Measurement conditions: For 500 VDC applied to the same location as for dielectric strength measurement.

Options (order separately)

Sockets

Model	Conn ection	Number of Pins	Terminal Type	Ambient operating temperature	Ambient humidity	Continuous carry current	Dielectric strength			Insulation resistance *1	Weight
							Between contact terminals of same polarity	Between contact terminals of different polarity	Between coil and contact terminals		
PYFZ-08-E	Front	8	Screw terminal	-55 to 70°C	5% to 85% RH	10 A	2,250 VAC 1 min	2,250 VAC 1 min	2,250 VAC 1 min	1,000 MΩ min. (500 VDC)	Approx. 32 g
PYF08A-N				-55 to 55°C	5% to 85% RH	7A *3	2,000 VAC 1 min	2,000 VAC 1 min	2,000 VAC 1 min	1,000 MΩ min. (500 VDC)	Approx. 32 g
PYF-08-PU		Push-In Plus Terminal	-40 to 70°C	5% to 85% RH	10A *2	2,000 VAC 1 min	2,000 VAC 1 min	2,000 VAC 1 min	1,000 MΩ min. (500 VDC)	Approx. 80 g	
PYFZ-14-E		14	Screw terminal	-55 to 70°C	5% to 85% RH	6A	2,250 VAC 1 min	2,250 VAC 1 min	2,250 VAC 1 min	1,000 MΩ min. (500 VDC)	Approx. 50 g
PYF14A-N				-55 to 55°C	5% to 85% RH	5A *3	2,000 VAC 1 min	2,000 VAC 1 min	2,000 VAC 1 min	1,000 MΩ min. (500 VDC)	Approx. 50 g
PYF-14-PU			Push-In Plus Terminal	-40 to 70°C	5% to 85% RH	6A	2,000 VAC 1 min	2,000 VAC 1 min	2,000 VAC 1 min	1,000 MΩ min. (500 VDC)	Approx. 87 g
PY08-02	Back	8	PCB terminals	-55 to 70°C	5% to 85% RH	7A	1,500 VAC 1 min	1,500 VAC 1 min	1,500 VAC 1 min	100 MΩ min.	Approx. 7.2 g
PY14-02		14		-55 to 70°C	5% to 85% RH	3A	1,500 VAC 1 min	1,500 VAC 1 min	1,500 VAC 1 min	100 MΩ min.	Approx. 10 g

*1. For 500 VDC applied to the same location as for dielectric strength measurement.

*2. The continuous carry current of 10 A is for an ambient temperature of 55°C. At an ambient temperature of 70°C, the value is 7 A.

*3. When using the PYF08A-N or PYF14A-N at an ambient operating temperature exceeding 40°C, reduce the continuous carry current to 60%.

Socket Accessories

For front-connecting Sockets

Short Bars

Application	Applicable sockets	Model	Maximum carry current	Ambient operating temperature	Ambient operating humidity
For Contact terminals (common)	PYF-08-PU(-L) PYF-14PU(-L)	PYDN-7.75-020□	20 A	-40 to 70°C	5% to 85%RH
		PYDN-7.75-030□			
		PYDN-7.75-040□			
		PYDN-7.75-200□			
For Coil terminals	PYF-08-PU(-L) PYF-14PU(-L)	PYDN-31.0-080□	20 A	-40 to 70°C	5% to 85%RH

Certified Ratings for Models Certified for Safety Standards

The rated values for safety standard certification are not the same as individually defined performance values. Always check the specifications before use.

Main unit

UL-certified Models: UL508

MY-GS	Number of poles	Coil ratings	Contact ratings	Certified number of operations
	2	12 VAC, 24 VAC, 48 VAC, 100/110 VAC, 110/120 VAC, 200/220 VAC, or 220/240 VAC 6 VDC, 12 VDC, 24 VDC, 48 VDC, 100/110 VDC, or 220 VDC	5 A, 30 VDC (General Use) 7 A, 30 VDC Resistive Load 5 A, 250 VAC (General Use) 7 A, 250 VAC Resistive Load	6,000 operations
	4	12 VAC, 24 VAC, 48 VAC, 100/110 VAC, 110/120 VAC, 200/220 VAC, or 220/240 VAC 6 VDC, 12 VDC, 24 VDC, 48 VDC, 100/110 VDC, or 220 VDC	3 A, 30 VDC (General Use) 6 A, 30 VDC Resistive Load 3 A, 250 VAC (General Use) 6 A, 250 VAC Resistive Load	6,000 operations

CSA-certified Models: CSA C22.2 No.14

MY-GS	Number of poles	Coil ratings	Contact ratings	Certified number of operations
	2	12 VAC, 24 VAC, 48 VAC, 100/110 VAC, 110/120 VAC, 200/220 VAC, or 220/240 VAC 6 VDC, 12 VDC, 24 VDC, 48 VDC, 100/110 VDC, or 220 VDC	5 A, 30 VDC (General Use) 7 A, 30 VDC Resistive Load 5 A, 250 VAC (General Use) 7 A, 250 VAC Resistive Load	6,000 operations
	4	12 VAC, 24 VAC, 48 VAC, 100/110 VAC, 110/120 VAC, 200/220 VAC, or 220/240 VAC 6 VDC, 12 VDC, 24 VDC, 48 VDC, 100/110 VDC, or 220 VDC	3 A, 30 VDC (General Use) 6 A, 30 VDC Resistive Load 3 A, 250 VAC (General Use) 6 A, 250 VAC Resistive Load	6,000 operations

VDE-certified Models: EN 61810-1

MY-GS	Number of poles	Coil ratings	Contact ratings	Certified number of operations
	2	12 VAC, 24 VAC, 48 VAC, 100/110 VAC, 110/120 VAC, 200/220 VAC, or 220/240 VAC 6 VDC, 12 VDC, 24 VDC, 48 VDC, 100/110 VDC, or 220 VDC	7 A, 30 VDC (L/R = 0) 7 A, 250 VAC (cosφ = 1)	10,000 operations
	4	12 VAC, 24 VAC, 48 VAC, 100/110 VAC, 110/120 VAC, 200/220 VAC, or 220/240 VAC 6 VDC, 12 VDC, 24 VDC, 48 VDC, 100/110 VDC, or 220 VDC	6 A, 30 VDC (L/R = 0) 6 A, 250 VAC (cosφ = 1)	10,000 operations

CQC-certified Models

Model	Standard number	Certification No.
MY-GS	GB/T 21711.1	CQC18002198531

Options (order separately)

Sockets

CSA certified (File No. LR031928)

Model	Ratings	Class number	Standard number
PYFZ-08-E	10A 250V	3211 07	CSA C22.2 No14
PYFZ-14-E	6A 250V *		
PYF08A-N	7A 250V		
PYF14A-N	7A 250V		
PYF-08-PU	10A 250V		
PYF-14-PU	6A 250V *		

* When power is supplied to all four poles, use with a total power current that does not exceed 20 A.

TÜV Rheinland certification

Model	Ratings	Standard number	Certification No.
PYFZ-08-E	10A 250V	EN 61984	R50405329
PYFZ-14-E	6A 250V		
PYF08A-N	7A 250V		J50224549
PYF14A-N			
PYF-08-PU	10A 250V *		R50327595
PYF-14-PU	6A 250V		

* Ratings are for an ambient temperature of up to 55°C. At an ambient temperature of 70°C, the value is 7A.

UL Standards Certification (File No. E87929)

Model	Ratings	Standard number	Category	Listed/Recognized
PYFZ-08-E	10A 250V	UL 508	SWIV2	Recognition
PYFZ-14-E	6A 250V *			
PYF08A-N	7A 250V			
PYF14A-N	7A 250V			
PYF-08-PU	10A 250V			
PYF-14-PU	6A 250V *			

* When power is supplied to all four poles, use with a total power current that does not exceed 20 A.

Engineering Data (Reference Value)

Maximum Switching Capacity

MY2□□-□□-GS (AC load)

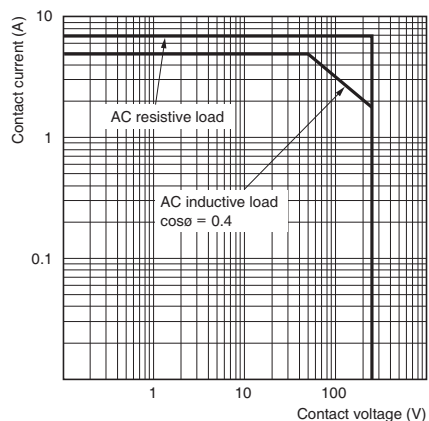

MY2□□-□□-GS (DC load)

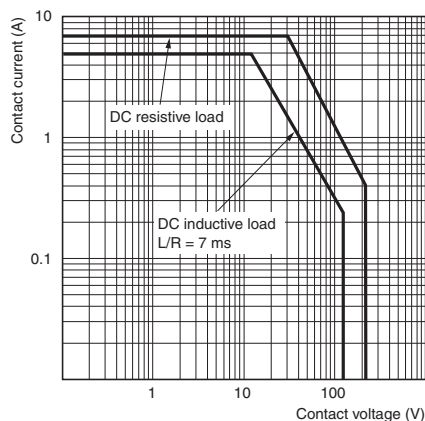

MY4□□-□□-GS (AC load)

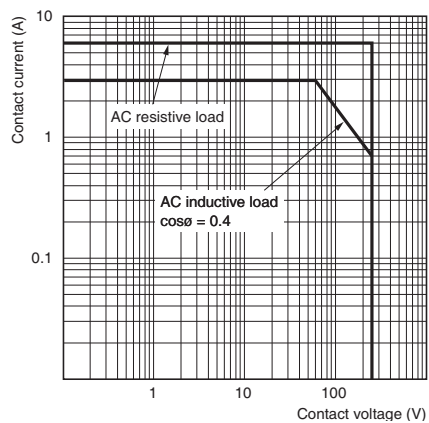

MY4□□-□□-GS (DC load)

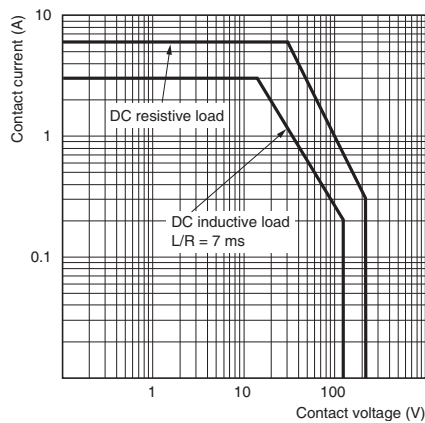

Endurance Curve

MY2□□-□□-GS (Resistive Load)

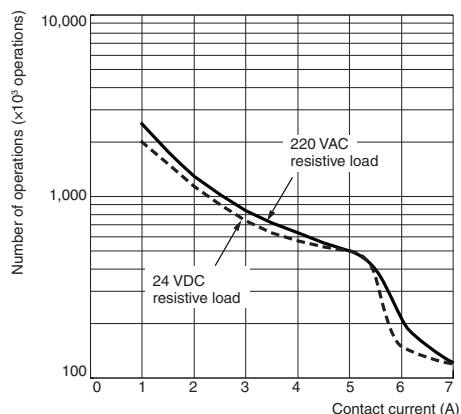

MY2□□-□□-GS (Inductive Load)

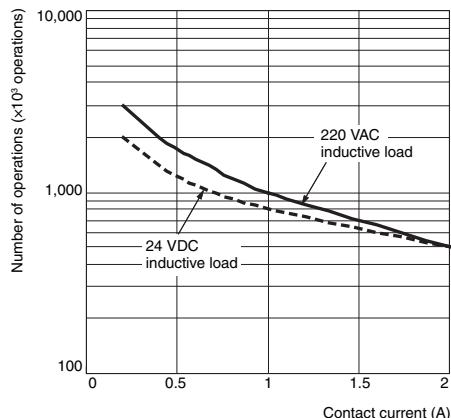

MY4□□-□□-GS (Resistive Load)

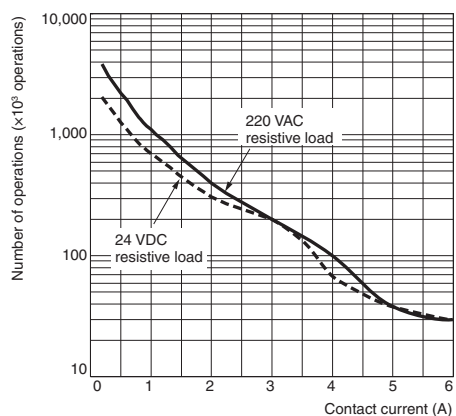

MY4□□-□□-GS (Inductive Load)

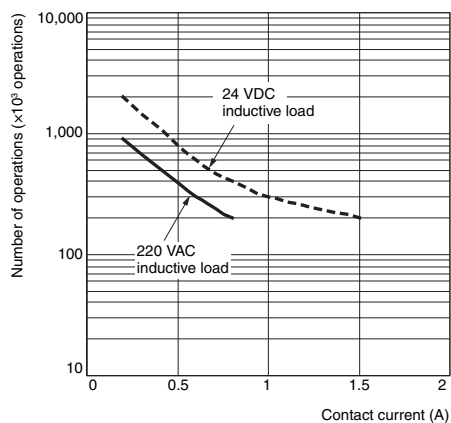

Note: 1. Number of operations: AC load, 50 Hz, 80%
 2. Switching condition: NO or NC

Ambient Temperature vs. Must-operate and Must-release Voltage

MY2□□-□□-GS AC Models

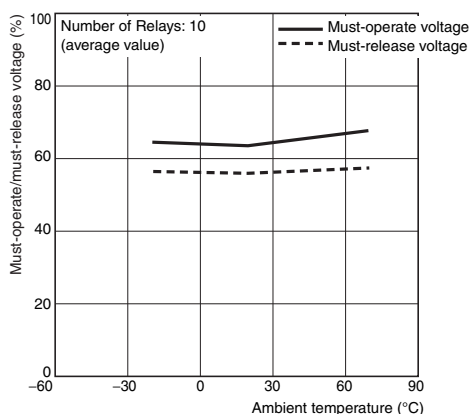

MY2□□-□□-GS DC Models

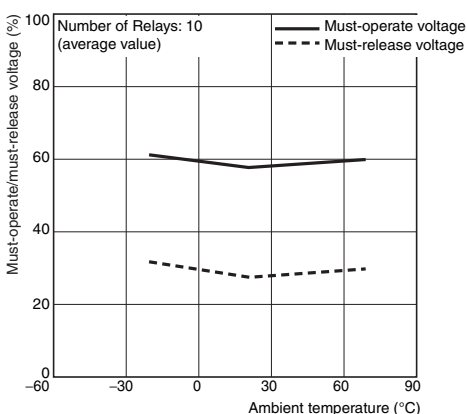

MY4□□-□□-GS AC Models

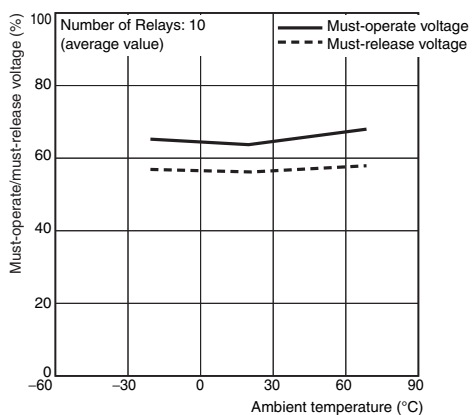

MY4□□-□□-GS DC Models

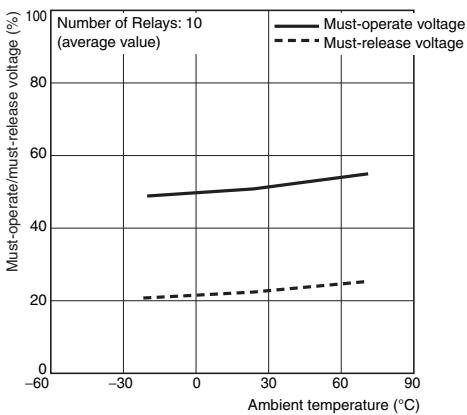

Ambient Temperature vs. Coil Temperature Rise

MY2□□-□□-GS AC Models, 50 Hz

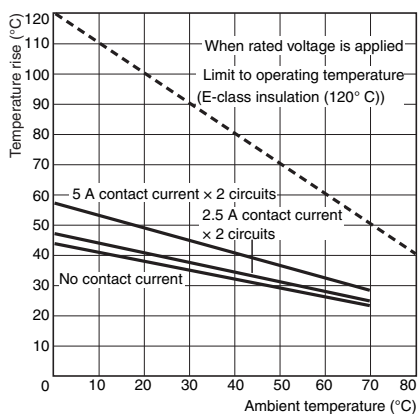

MY2□□-□□-GS DC Models

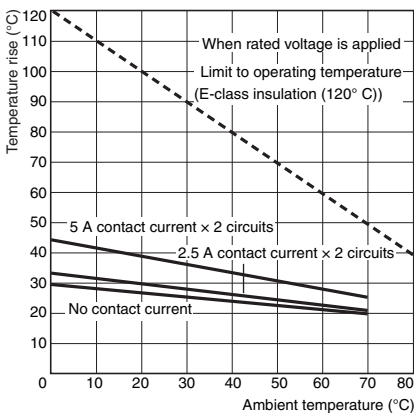

MY4□□-□□-GS AC Models, 50 Hz

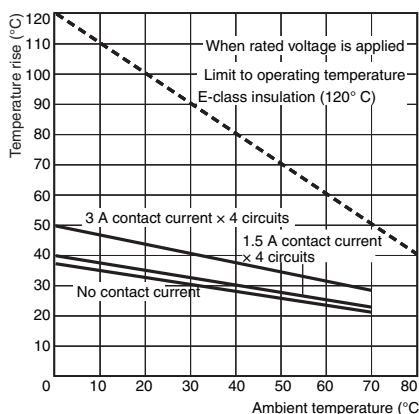

MY4□□-□□-GS DC Models

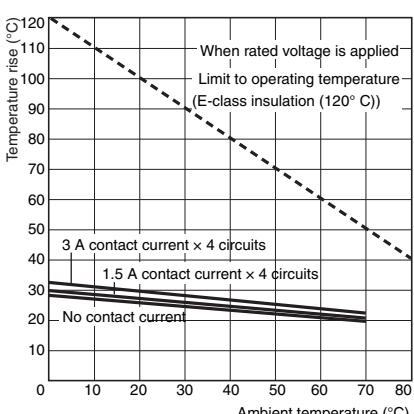

Dimensions

Relays

MY2-GS
MY2N-GS
MY2N-D2-GS
MY2N-CR-GS

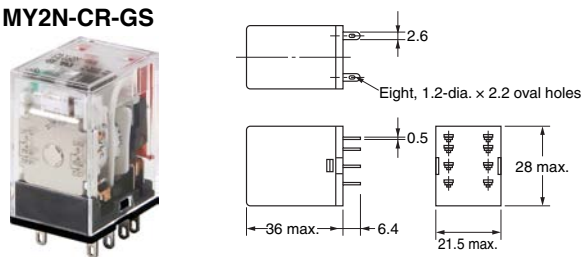

MY2IN-GS
MY2IN-D2-GS
MY2IN-CR-GS

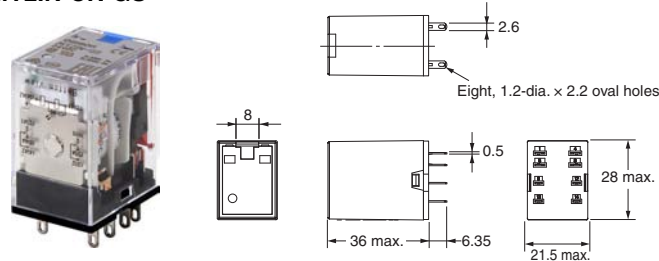

Terminal Arrangement/Internal Connections (Bottom View)

MY2-GS	MY2□N-GS			MY2□N-D2-GS		MY2□N-CR-GS
Standard Models	AC Models	DC Models (except 220 VDC)	DC Models (for 220 VDC)	DC Models (except 220 VDC)	DC Models (for 220 VDC)	AC Models
(The coil has no polarity.)	(The coil has no polarity.)	(The coil has polarity.)	(The coil has polarity.)	(The coil has polarity.)	(The coil has polarity.)	(The coil has no polarity.)

- Note:**
1. An AC model has coil disconnection self-diagnosis.
 2. For the DC models, check the coil polarity when wiring and wire all connections correctly.
 3. The indicator is red for AC and green for DC.
 4. The LED operation indicators indicate the energization of the coil and do not necessarily represent contact operation.

MY4-GS
MY4N-GS
MY4N-D2-GS
MY4N-CR-GS

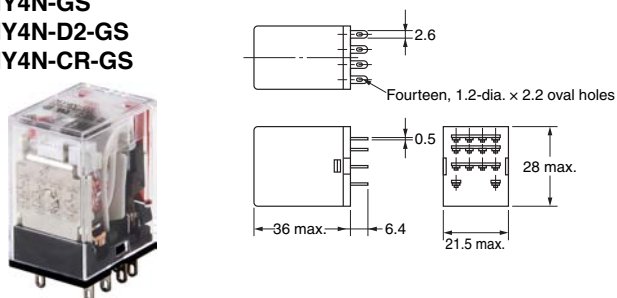

MY4IN-GS
MY4IN-D2-GS
MY4IN-CR-GS

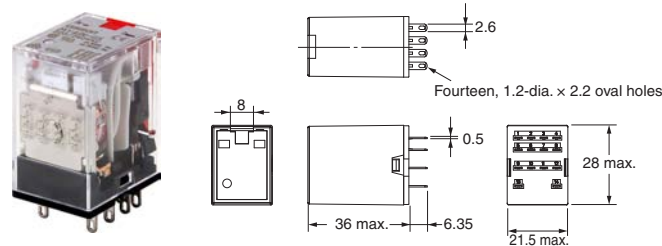

Terminal Arrangement/Internal Connections (Bottom View)

MY4-GS	MY4□N-GS			MY4□N-D2-GS		MY4□N-CR-GS
Standard Models	AC Models	DC Models (except 220 VDC)	DC Models (for 220 VDC)	DC Models (except 220 VDC)	DC Models (for 220 VDC)	DC Models
(The coil has no polarity.)	(The coil has no polarity.)	(The coil has polarity.)	(The coil has polarity.)	(The coil has polarity.)	(The coil has polarity.)	(The coil has no polarity.)

- Note:**
1. An AC model has coil disconnection self-diagnosis.
 2. For the DC models, check the coil polarity when wiring and wire all connections correctly.
 3. The indicator is red for AC and green for DC.
 4. The LED operation indicators indicate the energization of the coil and do not necessarily represent contact operation.

Options (Order Separately)

Connection Sockets

Front-mounting Sockets

PYFZ-08-E

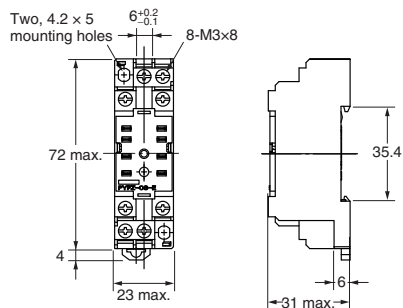

Terminal Arrangement/
Internal Connections
(Top View)

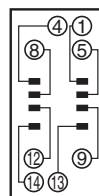

Mounting Hole
Dimensions (Top View)

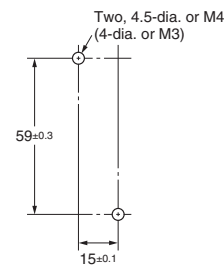

Note: Mounts to DIN Track.

PYFZ-14-E

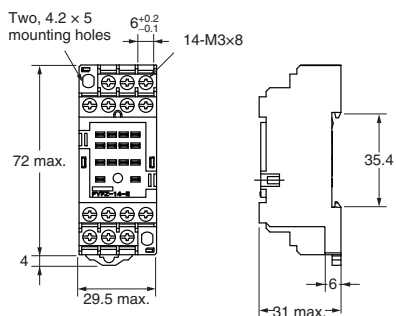

Terminal Arrangement/
Internal Connections
(Top View)

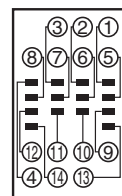

Mounting Hole
Dimensions (Top View)

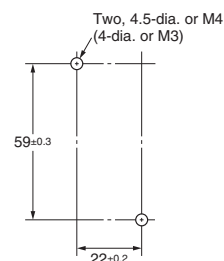

Note: Mounts to DIN Track.

PYF08A-N

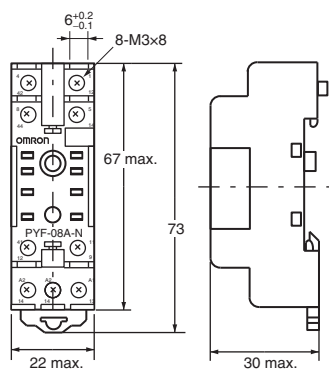
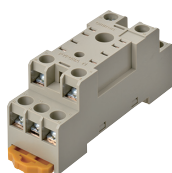

Terminal Arrangement/
Internal Connections
(Top View)

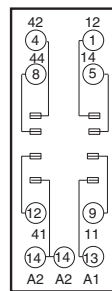

Mounting Hole
Dimensions (Top View)

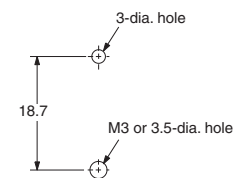

Note: Mounts to DIN Track.

PYF14A-N

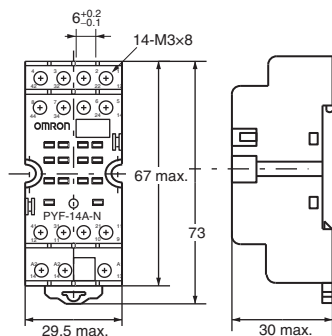

Terminal Arrangement/
Internal Connections
(Top View)

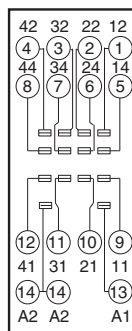

Mounting Hole
Dimensions (Top View)

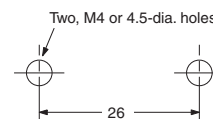

Note: Mounts to DIN Track.

PYF-08-PU

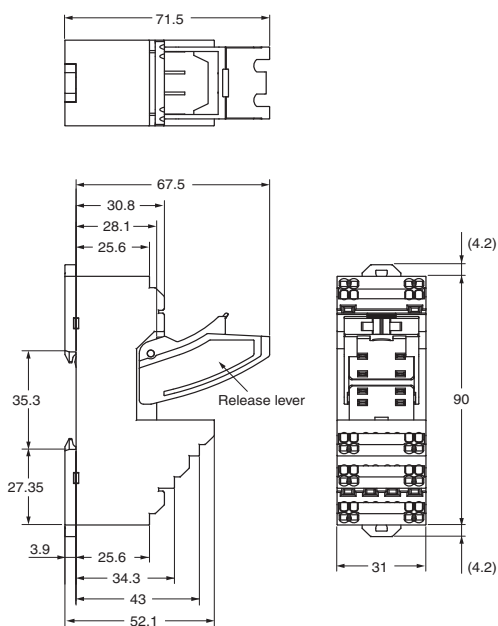

Terminal Arrangement/
Internal Connection Diagram
(TOP VIEW)

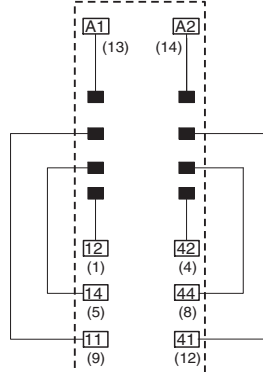

Note: The numbers in parentheses are traditionally used terminal numbers.

Mounting Hole Dimensions

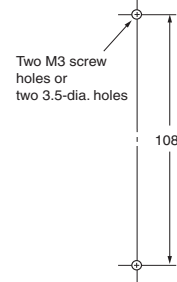

Note: Pull out the hooks to mount the Socket with screws.

PYF-14-PU

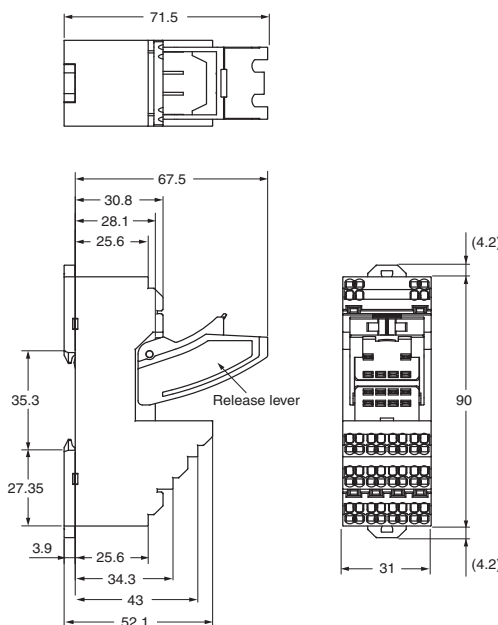

Terminal Arrangement/
Internal Connection Diagram
(TOP VIEW)

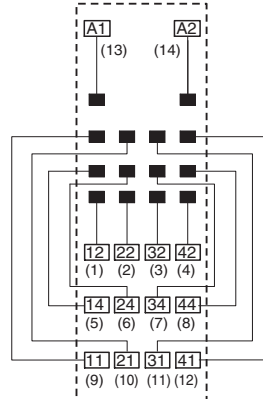

Note: The numbers in parentheses are traditionally used terminal numbers.

Mounting Hole Dimensions

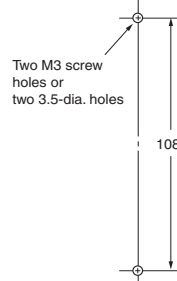

Note: Pull out the hooks to mount the Socket with screws.

Back-mounting Sockets

PY08-02

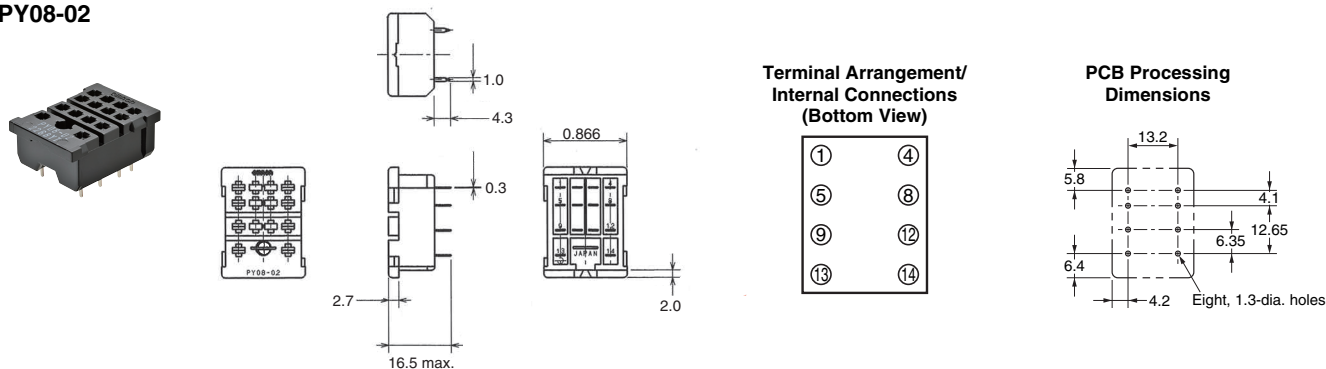

PY14-02

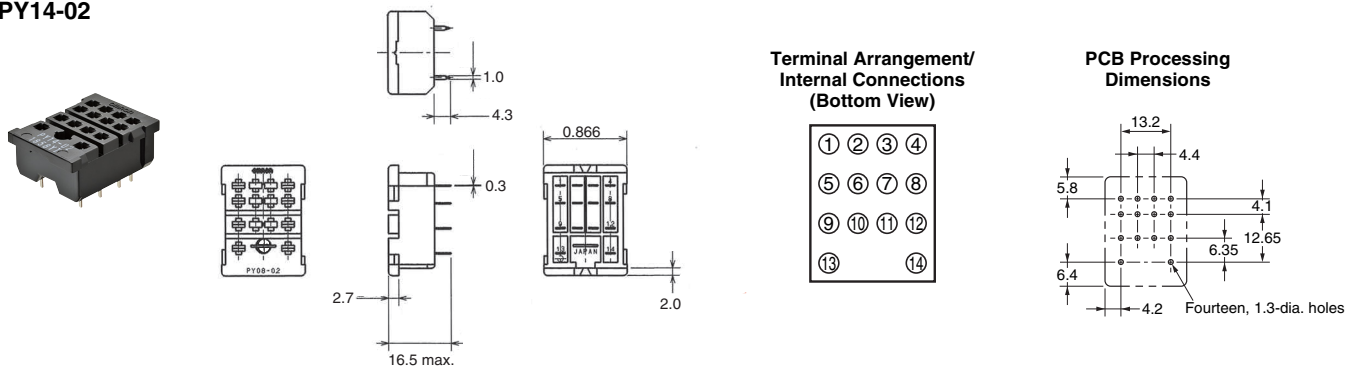

Socket Accessories

Hold-down Clips

PYC-A1

Set of 2 clips

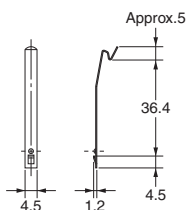

PYC-P

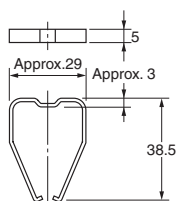

Mounting Heights with Sockets (Unit: mm)

Front-mounting Sockets

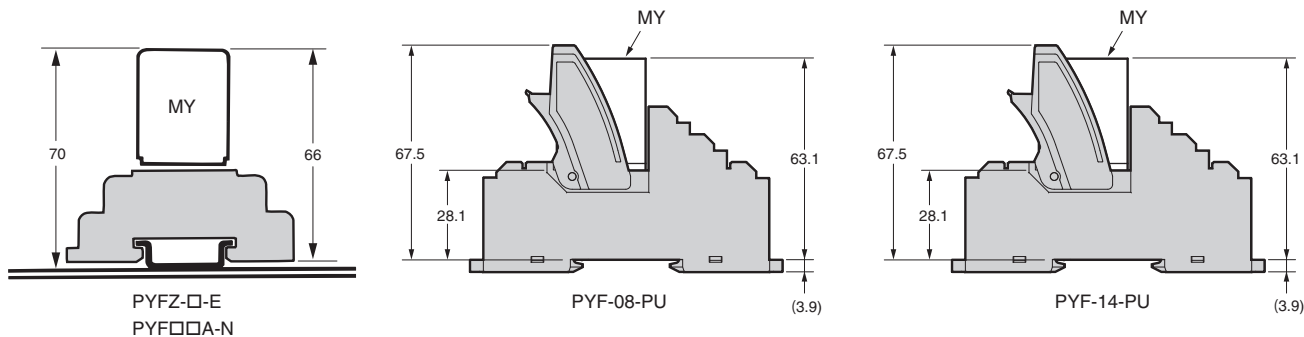

Back-mounting Sockets

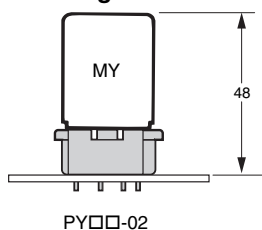

Safety Precautions

Refer to the *Common Relay Precautions* for precautions that apply to all Relays in the website at the following URL: <http://www.ia.omron.com/>.

Precautions for Correct Use

Handling

For models with built-in LED operation indicators, check the coil polarity when wiring and wire all connections correctly. (DC operation).

Installation

There is no specifically required installation orientation, but make sure that the Relays are installed so that the contacts are not subjected to vibration or shock in their movement direction.

Using MY-GS Relays with Microloads with Infrequent Operation

If standard MYGS Relays are used to infrequently switch microloads, the contacts may become unstable and eventually result in poor contact. In this case, we recommend using the MY4Z-CBG Series, which has high contact reliability for microloads

Relay Replacement

To replace the Relay, turn OFF the power supply to the load and Relay coil sides to prevent unintended operation and possible electrical shock.

Applicable Sockets

Use only combinations of OMRON Relays and Sockets.

- Use the following tightening torque for screws during wiring.

Model	Tightening torque
PYFZ-08-E PYFZ-14-E	0.59 to 0.88 N·m * Use a No. 1 screwdriver.

- Use the following wire diameters as a guide for wiring. (Select the appropriate wire diameter for the current used.)

Model	Recommended wire diameter (mm ²)	
PYFZ-08-E PYFZ-14-E	Stranded wire	0.75 to 2.5 mm ² AWG 18 to 14
	Solid wire	0.75 to 1.5 mm ² AWG 18 to 16

Latching Levers

- Turn OFF the power supply when operating the latching lever. After you use the latching lever always return it to its original state.
- Do not use the latching lever as a switch.
- The latching lever can be used for 100 operations min.

Terms and Conditions Agreement

Read and understand this catalog.

Please read and understand this catalog before purchasing the products. Please consult your OMRON representative if you have any questions or comments.

Warranties.

(a) Exclusive Warranty. Omron's exclusive warranty is that the Products will be free from defects in materials and workmanship for a period of twelve months from the date of sale by Omron (or such other period expressed in writing by Omron). Omron disclaims all other warranties, express or implied.

(b) Limitations. OMRON MAKES NO WARRANTY OR REPRESENTATION, EXPRESS OR IMPLIED, ABOUT NON-INFRINGEMENT, MERCHANTABILITY OR FITNESS FOR A PARTICULAR PURPOSE OF THE PRODUCTS. BUYER ACKNOWLEDGES THAT IT ALONE HAS DETERMINED THAT THE PRODUCTS WILL SUITABLY MEET THE REQUIREMENTS OF THEIR INTENDED USE.

Omron further disclaims all warranties and responsibility of any type for claims or expenses based on infringement by the Products or otherwise of any intellectual property right. (c) Buyer Remedy. Omron's sole obligation hereunder shall be, at Omron's election, to (i) replace (in the form originally shipped with Buyer responsible for labor charges for removal or replacement thereof) the non-complying Product, (ii) repair the non-complying Product, or (iii) repay or credit Buyer an amount equal to the purchase price of the non-complying Product; provided that in no event shall Omron be responsible for warranty, repair, indemnity or any other claims or expenses regarding the Products unless Omron's analysis confirms that the Products were properly handled, stored, installed and maintained and not subject to contamination, abuse, misuse or inappropriate modification. Return of any Products by Buyer must be approved in writing by Omron before shipment. Omron Companies shall not be liable for the suitability or unsuitability or the results from the use of Products in combination with any electrical or electronic components, circuits, system assemblies or any other materials or substances or environments. Any advice, recommendations or information given orally or in writing, are not to be construed as an amendment or addition to the above warranty.

See <http://www.omron.com/global/> or contact your Omron representative for published information.

Limitation on Liability: Etc.

OMRON COMPANIES SHALL NOT BE LIABLE FOR SPECIAL, INDIRECT, INCIDENTAL, OR CONSEQUENTIAL DAMAGES, LOSS OF PROFITS OR PRODUCTION OR COMMERCIAL LOSS IN ANY WAY CONNECTED WITH THE PRODUCTS, WHETHER SUCH CLAIM IS BASED IN CONTRACT, WARRANTY, NEGLIGENCE OR STRICT LIABILITY.

Further, in no event shall liability of Omron Companies exceed the individual price of the Product on which liability is asserted.

Suitability of Use.

Omron Companies shall not be responsible for conformity with any standards, codes or regulations which apply to the combination of the Product in the Buyer's application or use of the Product. At Buyer's request, Omron will provide applicable third party certification documents identifying ratings and limitations of use which apply to the Product. This information by itself is not sufficient for a complete determination of the suitability of the Product in combination with the end product, machine, system, or other application or use. Buyer shall be solely responsible for determining appropriateness of the particular Product with respect to Buyer's application, product or system. Buyer shall take application responsibility in all cases.

NEVER USE THE PRODUCT FOR AN APPLICATION INVOLVING SERIOUS RISK TO LIFE OR PROPERTY OR IN LARGE QUANTITIES WITHOUT ENSURING THAT THE SYSTEM AS A WHOLE HAS BEEN DESIGNED TO ADDRESS THE RISKS, AND THAT THE OMRON PRODUCT(S) IS PROPERLY RATED AND INSTALLED FOR THE INTENDED USE WITHIN THE OVERALL EQUIPMENT OR SYSTEM.

Programmable Products.

Omron Companies shall not be responsible for the user's programming of a programmable Product, or any consequence thereof.

Performance Data.

Data presented in Omron Company websites, catalogs and other materials is provided as a guide for the user in determining suitability and does not constitute a warranty. It may represent the result of Omron's test conditions, and the user must correlate it to actual application requirements. Actual performance is subject to the Omron's Warranty and Limitations of Liability.

Change in Specifications.

Product specifications and accessories may be changed at any time based on improvements and other reasons. It is our practice to change part numbers when published ratings or features are changed, or when significant construction changes are made. However, some specifications of the Product may be changed without any notice. When in doubt, special part numbers may be assigned to fix or establish key specifications for your application. Please consult with your Omron's representative at any time to confirm actual specifications of purchased Product.

Errors and Omissions.

Information presented by Omron Companies has been checked and is believed to be accurate; however, no responsibility is assumed for clerical, typographical or proofreading errors or omissions.

X-ON Electronics

Largest Supplier of Electrical and Electronic Components

Click to view similar products for [Industrial Relays](#) category:

Click to view products by [Omron](#) manufacturer:

Other Similar products are found below :

[6-1617801-8](#) [6-1618107-9](#) [7-1618273-3](#) [EV250-4A-02](#) [EV250-6A-01](#) [FCA-125-CX8](#) [FCA-325-159](#) [FCA-410-138](#) [GCA63A220VAC60HZ](#)
[GCA63A600VAC60HZ](#) [1-1672275-3](#) [1-1833005-4](#) [H-16/S1](#) [H-8C](#) [ACC530U20](#) [RF303ZM4-12](#) [DH18DA](#) [RM699BV-3011-85-1005](#) [AR4-](#)
[15F13-C01](#) [AR7-41F11](#) [AVR907](#) [15732A200](#) [B329](#) [B490A](#) [1618279-1](#) [BHR124Y](#) [N417](#) [2071229-4](#) [2-1618105-9](#) [2-1618396-6](#) [2-](#)
[1618398-1](#) [JMAPD-5XL](#) [JMGACD-5M](#) [JMGSCD-5L](#) [KA-3C-12A](#) [2307497](#) [RT334012WG](#) [301-17SX](#) [SL6H3-26.5VDC](#) [1618105-2](#)
[1618112-6](#) [1618113-5](#) [1618276-6](#) [A837D](#) [A862B1](#) [ACC530U10](#) [ACC730-8025B](#) [SZ-RW1](#) [SZ-RW4](#) [SZ-T13](#)