

Programmable Terminals

NS Series

NS, the HMI brand you can rely on



» Proven Reliability

» Best Match

» Machine Management

NS, the HMI brand you can rely on

Machine Control at Your Fingertips. On-screen Machine Management.

Expanding markets in emerging countries, short product cycles, and diversifying customer needs are just some of the factors that create drastic changes for the production industry.

To win in severe global market competition, you have to continue to grasp industry changes quickly, understand user needs accurately, and provide diverse forms of added value.

OMRON will help you handle ever-changing customer needs with the three keywords of the NS Series.

Let Your Machines Evolve

Best Match

OMRON has provided even greater compatibility with OMRON PLCs and components to provide an advanced design process that lets you achieve appealing machines.

Machine Management

The NS Series transforms machine HMIs from simple operation panels and turns them into machine management tools.

Proven Reliability

The NS-series PTs have a proven track record that will take your machines to a higher level of reliability.

NS Series



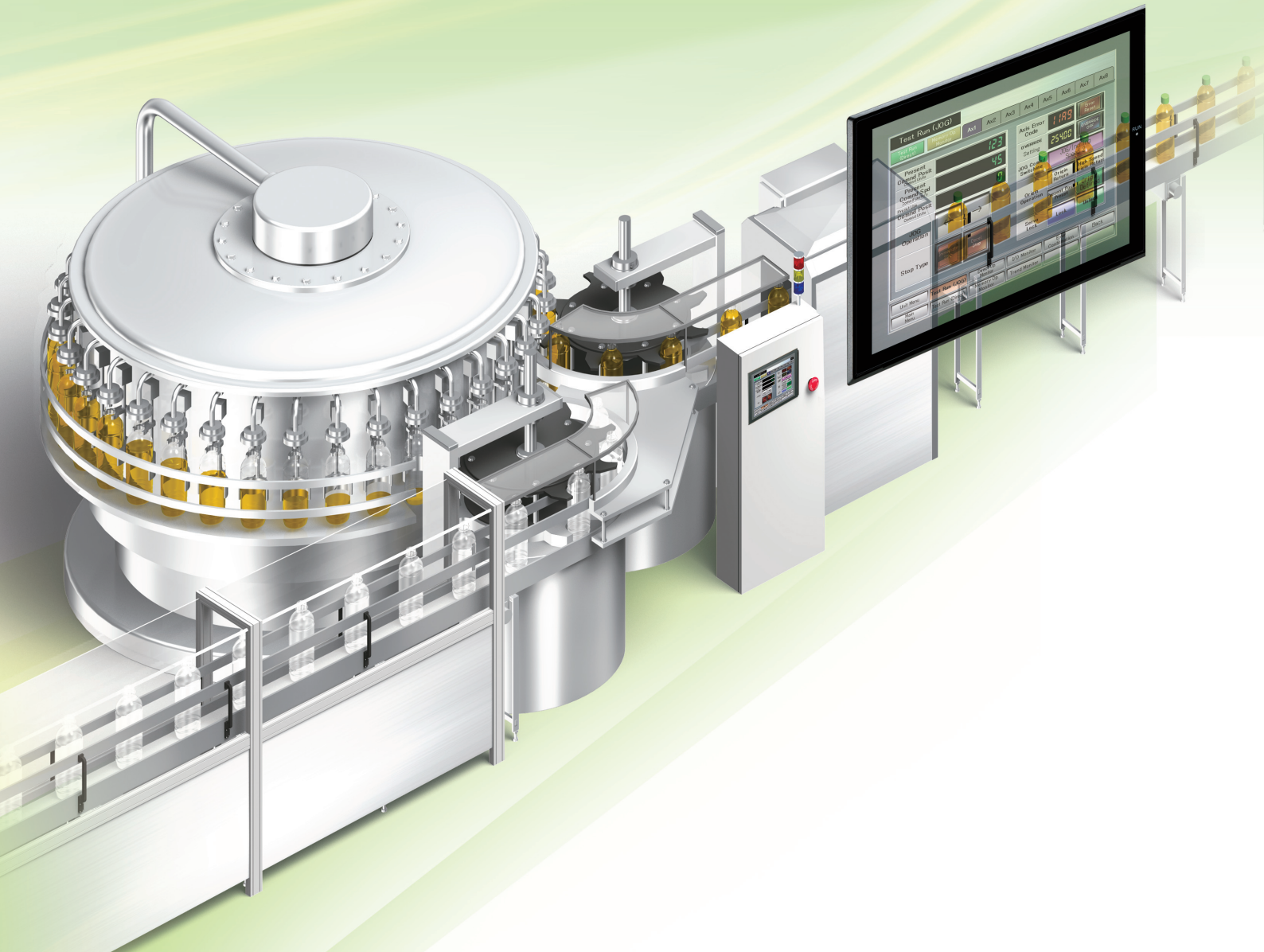

The Best Match Possible

The amount of work and cost of connecting to OMRON PLCs and components have been greatly reduced. The results is an incredible range of features that is possible only when unifying to one manufacturer.

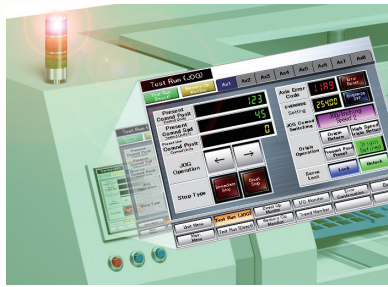

Machine Management Tool

The machine designer can easily implement PLC troubleshooting, machine troubleshooting, settings for servo drives, temperature controllers, and other control components, status monitoring of connected devices, and uploading/downloading of parameters.



Proven Reliability

In the ten years since initial marketing, OMRON has globally supplied numerous HMI solutions with the highly reliable NS Series at over 200 sales and service centers around the world.

NS Series Lineup

This powerful lineup showcases OMRON's unique value.

Choose from 3 types to match your application and requirements.

NS Series

Standard Models

Plentiful screen variations and diverse functions allow use in a wide variety of applications.

15 inches Color TFT



NS15-TX

- || 32,768 colors
- || XGA 1024 x 768 pixels
- || Screen memory size: 60 MB
- USB Slave
- Controller Link
- Ethernet
- Video (RGB input only)
- USB Master
- RGB output
- RS-232C x 2
- Ladder Monitor
- RS-422A/485
- Memory Card

12.1 inches Color TFT



NS12-TS

- || 32,768 colors
- || SVGA 800 x 600 pixels
- || Screen memory size: 60 MB
- USB Slave
- Controller Link
- Ethernet
- Video
- USB Master
- Ladder Monitor
- RS-232C x 2
- Memory Card

10.4 inches Color TFT



NS10-TV

- || 32,768 colors
- || VGA 640 x 480 pixels
- || Screen memory size: 60 MB
- USB Slave
- Controller Link
- Ethernet
- Video
- USB Master
- Ladder Monitor
- RS-232C x 2
- Memory Card

8.4 inches Color TFT



NS8-TV

- || 32,768 colors
- || VGA 640 x 480 pixels
- || Screen memory size: 60 MB
- USB Slave
- Video
- Ethernet
- Ladder Monitor
- USB Master
- Memory Card
- RS-232C x 2

5.7 inches Color High-luminance TFT



NS5-TQ

- || 32,768 colors
- || QVGA 320 x 240 pixels
- || Screen memory size: 60 MB
- USB Slave
- Ethernet
- RS-232C x 2
- Memory Card

5.7 inches Color TFT



NS5-SQ

- || 32,768 colors
- || QVGA 320 x 240 pixels
- || Screen memory size: 60 MB
- USB Slave
- Ethernet
- RS-232C x 2
- Memory Card

NSH Series

Hand-held Models

A hand-held version of the NS5 is now available to perform operations at the production site.

5.7 inches Color TFT



NSH5-SQR

- || 32,768 colors
- || QVGA 320 x 240 pixels
- USB Slave
- RS-232C/422A
- Memory Card

- || Equipped with a red switch for an emergency stop input.
- || Emergency stop (3 inputs)

5.7 inches Color TFT



NSH5-SQG

- || 32,768 colors
- || QVGA 320 x 240 pixels
- USB Slave
- RS-232C/422A
- Memory Card

- || Equipped with a gray switch for a stop input.
- || Emergency stop (3 inputs)

Hand-held PT Cable



RS-232C RS-422A

NSJ Series

Integrated Controller Models

PT is unified with the Controller into one package to greatly help standardize equipment and reduce size.

12.1 inches **Color TFT**



NSJ12-TS□□-G5D

- || 32,768 colors
- || SVGA 800 x 600 pixels
- || Screen memory size: 60 MB

- | | |
|-------------|-----------------|
| USB Slave | Controller Link |
| Ethernet | Ladder Monitor |
| USB Master | Memory Card |
| RS-232C x 3 | DeviceNet |

(Controller Section)

- || I/O points: 1,280
- || Program capacity: 60K steps
- || Data Memory: 128K words

10.4 inches **Color TFT**



NSJ10-TV□□-G5D

- || 32,768 colors
- || VGA 640 x 480 pixels
- || Screen memory size: 60 MB

- | | |
|-------------|-----------------|
| USB Slave | Controller Link |
| Ethernet | Ladder Monitor |
| USB Master | Memory Card |
| RS-232C x 3 | DeviceNet |

(Controller Section)

- || I/O points: 1,280
- || Program capacity: 60K steps
- || Data Memory: 128K words

8.4 inches **Color TFT**



NSJ8-TV□□-M3D

- || 32,768 colors
- || VGA 640 x 480 pixels
- || Screen memory size: 60 MB

- | | |
|-------------|-----------------|
| USB Slave | Controller Link |
| Ethernet | Ladder Monitor |
| USB Master | Memory Card |
| RS-232C x 3 | DeviceNet |

(Controller Section)

- || I/O points: 640
- || Program capacity: 20K steps
- || Data Memory: 32K words

8.4 inches **Color TFT**



NSJ8-TV□□-G5D

- || 32,768 colors
- || VGA 640 x 480 pixels
- || Screen memory size: 60 MB

- | | |
|-------------|-----------------|
| USB Slave | Controller Link |
| Ethernet | Ladder Monitor |
| USB Master | Memory Card |
| RS-232C x 3 | DeviceNet |

(Controller Section)

- || I/O points: 1,280
- || Program capacity: 60K steps
- || Data Memory: 128K words

5.7 inches **Color TFT**



NSJ5-SQ□□-M3D/-G5D

- || 32,768 colors
- || QVGA 320 x 240 pixels
- || Screen memory size: 60 MB

- | | |
|-------------|-----------------|
| USB Slave | Controller Link |
| Ethernet | Memory Card |
| RS-232C x 3 | DeviceNet |

(Controller Section)

- | | |
|-----------------------------|-----------------------------|
| M3D | G5D |
| I/O points: 640 | I/O points: 1280 |
| Program capacity: 20K steps | Program capacity: 60K steps |
| Data Memory: 32K words | Data Memory: 128K words |

5.7 inches **Color High-luminance TFT**



NSJ5-TQ□□-M3D/-G5D

- || 32,768 colors
- || QVGA 320 x 240 pixels
- || Screen memory size: 60 MB

- | | |
|-------------|-----------------|
| USB Slave | Controller Link |
| Ethernet | Memory Card |
| RS-232C x 3 | DeviceNet |

(Controller Section)

- | | |
|-----------------------------|-----------------------------|
| M3D | G5D |
| I/O points: 640 | I/O points: 1280 |
| Program capacity: 20K steps | Program capacity: 60K steps |
| Data Memory: 32K words | Data Memory: 128K words |

Software

CX-Designer



Without screen creation and ladder programming, the CX-Designer Screen Design Software is so easy-to-use that anyone can master it.

NS-Runtime



This software enables PLC communications from a personal computer by manipulating PT screens created using the CX-Designer.

A Revolutionary Best Ma

The NS-series PTs provide revolutionary compatibility with the road-proven CS/CJ-series the new NJ/NX-series Controllers to achieve even greater added value in user machines.

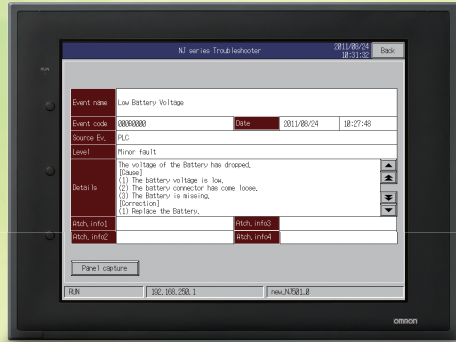

The NJ/NX-series Machine Automation Controllers Revolutionize Productivity

You can create a flexible, high-speed, high-precision system based on the NJ-series Machine Automation Controllers. Use tags to access any memory areas, or troubleshoot machines and systems by using the NS-series PTs to make the most of the strengths of the NJ/NX-series Controllers and to manage machines.

EtherNet/IP



NJ

EtherCAT

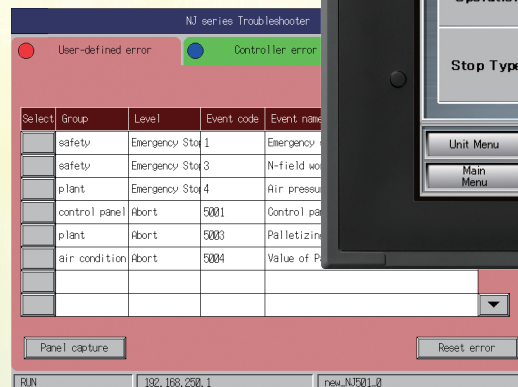

The CS/CJ-series PLCs for the Reliability of a Proven Track Record

Features are provided to easily connect to CS/CJ-series PLCs to take advantage of their proven track record.

Many features that do not require screen creation or programming support everything from design through maintenance to take advantage of the compatibility of OMRON PLCs and PT and to serve as the face of your machines.

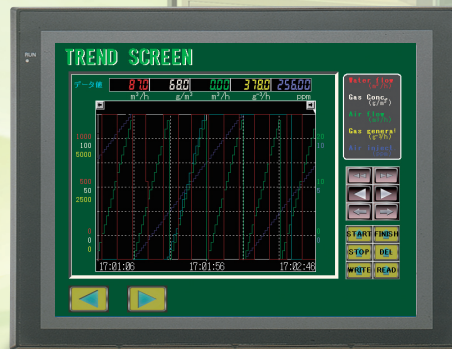

CS/CJ

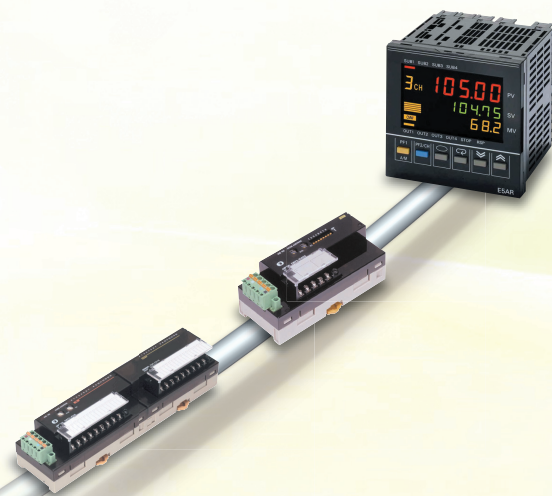

Power Support for All User

From conceptual designs through commissioning, operation, and maintenance, the NS



Design

Reduced work



**For Machine Automation
Controllers NJ/NX-series**

P10

NJ Troubleshooter
Integrated NS-series PT simulation



Troubleshooter

P11

CS/CJ-series PLC Troubleshooter
Machine Troubleshooter

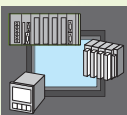

**Best Match with
OMRON Products**

P12-P16

Smart Active Parts (SAP)
EtherNet/IP
Direct Connection to Temperature Controllers
Face Plate Auto-Builder for NS



Multi-language Support

P17



Multifunction Objects

P18

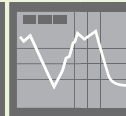

Plentiful Graphing Functions

P19



**Screen Data
Security Functions**

P20



Device Data Transfer

P20



NS Screen Templates

P21



**CX-Designer Screen
Design Software**

P22-P25

Needs

Series supports every user need.

Startup/Operation

Attractive,
convenient features
for easier operation



Level:01
Level:02
Level:03
Level:04
Level:05

analog
RGB



260,000-color Video Display

P26

analog
RGB

Analog RGB Output

P26



FTP Function

P27

Level:01
Level:02
Level:03
Level:04
Level:05

User Security Functions

P27

LED

LED backlight

P27

Maintenance

Features for reliability
and complete
maintenance



Comparison

P28

SPMA

Single Port Multi Access

P28

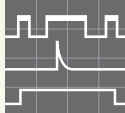

PLC Data Trace

P29



Operating log

P29

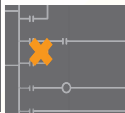

Ladder Monitor

P30-P31

For Machine Automation Controllers NJ/NX-series

Use Integrated NS-series PT simulation or NJ troubleshoot by using the NS-series PTs to make the most of the strengths of the NJ/NX-series Controllers and to manage machines.

NJ Troubleshooter

Controller Errors

Standard Feature for NJ/NX-series Controllers

Errors are automatically detected and displayed on-screen along with corrective actions for the CPU Unit function modules, EtherCAT slaves, and CJ-series Units that are connected in the NJ/NX-series Controller. Whenever an error might occur, you can recover normal operation quickly to reduce downtime without using user manuals or Support Software on a computer.



User-defined Errors

No Work Is Required to Create Alarm Screens.

Frames for alarm screens are provided as standard features in the NS-series PTs. You do not need to create screens to complete alarm screens. Management of the meanings of alarms is unified on the Controller, so you do not have to register, add, or correct addresses on the NS-series PTs.

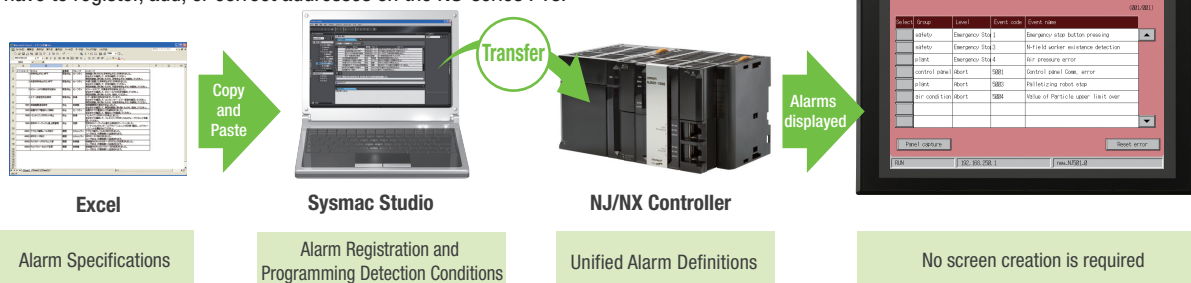

Integrated NS-series PT simulation

Improved debugging efficiency

"Integrated simulation" of Sysmac Studio enables offline debugging of the screen data for the NS-series PTs and sequence program for the NJ/NX-series on the computer.

* Sysmac Studio version 1.02 or higher (CX-Designer version 3.41 or higher) is required.

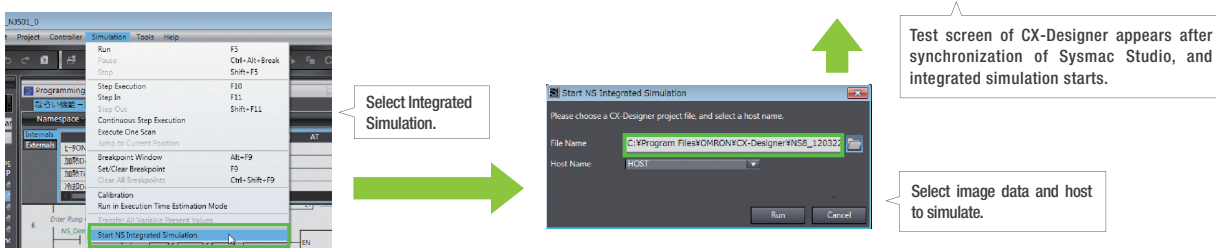

Troubleshooter

A Troubleshooter is provided for the connected OMRON Controller or PLC. This greatly reduces work requirements.

CS/CJ-series PLC Troubleshooter

Constantly monitors PLC errors.

Automatically detects PLC errors and displays the error details and recovery procedure on the screen. Even if a problem occurs, it can be resolved quickly without referring to the manuals.

NodeAddress	00	01	02	03	04	05	06	07	08	09	10	11	12	13	14	15
RegisteredSlave																
NormalSlave																

Non Fatal Error

Error Name	Details	Code
Battery Error	[A402_04]	000F

Battery Error

Details

<Details>
This error occurs when the PLC Setup has been set to detect battery errors and the CPU Unit's backup battery is

Countermeasure

Battery Error

CS/CJ/CP-series PLC

Note: A special template is required when using this function. The screen template is supplied with CX-Designer of version 2.1 or later. This function is a standard feature in the NSJ-series PTs.

Machine Troubleshooter

Easier Design of Machine Error Screens

Individual error screens that were previously made for each error can now be integrated into one. It is possible to switch only the error details (text and screen) without ladder programming in conjunction with the alarm bit.

With this system, this frame is shared, and the error details in the pink frames are switched with an alarm or other item as the trigger.

0002 Upper part, Paper blocked

Paper was blocked in upper unit. It is thought the paper is no good.

Please make the cover of the transportation part in the unit when passing the lock release button of the book. Please remove the blocked paper. Please confirm whether scraps of the paper remain in the transportation

Text selection

Image selection

Specific Example

in conjunction with an alarm bit (See note.)

Alarm bit 10.01 ON (no paper)

Counter measure

Please draw out tray 1 forward. Please set a new paper in the direction like photo. Please the paper diagonally must not be set or not use the distorted paper, and the paper blocking might not be generated and not use.

Alarm bit 10.02 ON (printing error)

Counter measure

The dirt of the reading part is thought. Please clean the reading part glass by using alcohol and the cotton waste in the maintenance box. Please exchange the reading units when not improving it even if it cleans it.

Note: Alarms, PLC/PT memory, and other items can be selected for the switching trigger.

Design

Best Match with OMRON Products

NS Series is the most suitable HMI for the system that comprises OMRON components. The advantage is the "compatibility (reducing programming and screen data creation work)" which will reduce the amount of designing work.

NS



No Screen Designing / No Programming

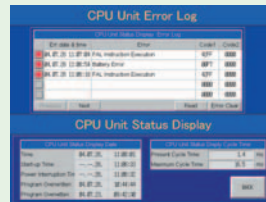

PLC CPU Unit monitoring screen

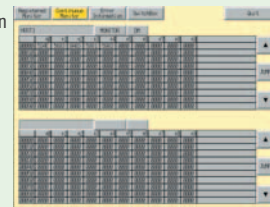

Device monitor

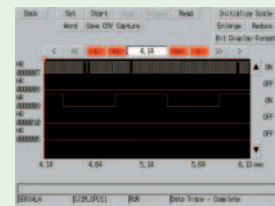

PLC Data Trace

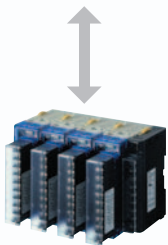

Temperature Controllers



PLC

CPU Bus Units and Special I/O Units

- SAP Library
- Troubleshooting



Remote I/O Terminal



Inverter



Vision Sensor

- 260,000-color video input



Temperature Controllers



Servomotor Servo Driver



Smart Active Parts (SAP Library)

Dramatically reduces the effort required to create ladder programming and screens.

More than 3,000 Library parts (Smart Active Parts) are available, which can directly access OMRON PLCs and components. The objects can just be pasted from the Smart Active Parts (SAP Library) Library to the screen; it is completely unnecessary to create screens and ladder programming.

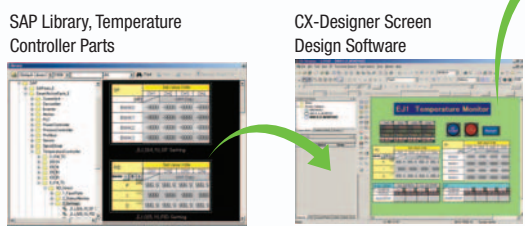

The Temperature Controller's setting and monitor screens are completed in no time.

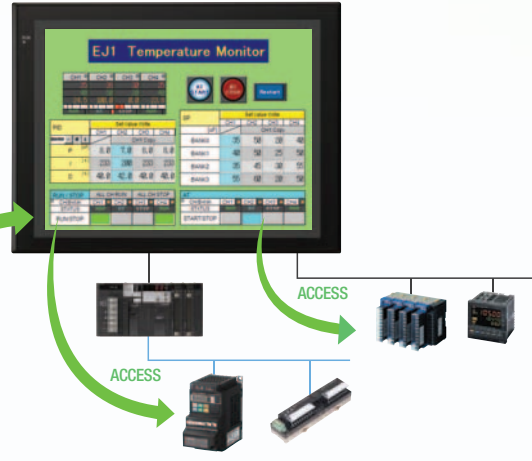

Support tool objects can be incorporated to check for errors and make settings, even without a computer.

Plenty of support tool objects (the Tool Function SAP Library) are available, which can be easily incorporate support tool functions in the NS-series PT. Just paste the support tool objects in the screen to check for errors and make settings, even without a computer.

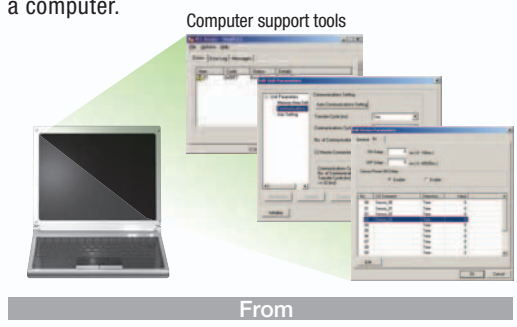

Example screens using support tool objects (Tool Function SAP Library)



CPU Bus Unit and Special I/O Unit Troubleshooting Can Be Also Performed with the SAP Library.

A Troubleshooter SAP Library is available to troubleshoot each Unit in the PLC. When an error occurs in a Unit, the Troubleshooter SAP Library provides an easy-to-understand explanation of the cause of the error as well as the countermeasures.

Note: The Troubleshooter SAP Library is included as a standard feature for the CX-One and CX-Designer. For details, refer to page 56. Successive development for Ethernet Units and MC Units is planned for the future.

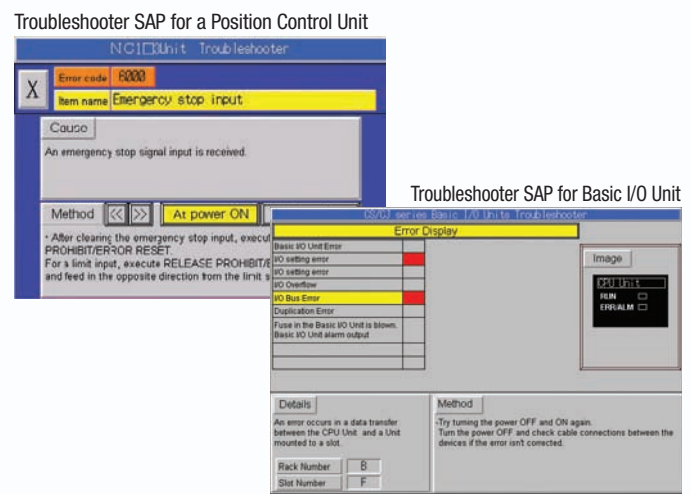

Design

EtherNet/IP

Support for data structures

This special feature is made possible by combining an OMRON CJ2/NJ/NX PLC with an NS-series PT. The data structures that you define on the Programming Tool can be used on the CX-Designer simply by dragging and dropping them.

Note: When connecting to each controller with EtherNet / IP, check the version of CX-Designer and NS on page 15 "Connectable Devices".

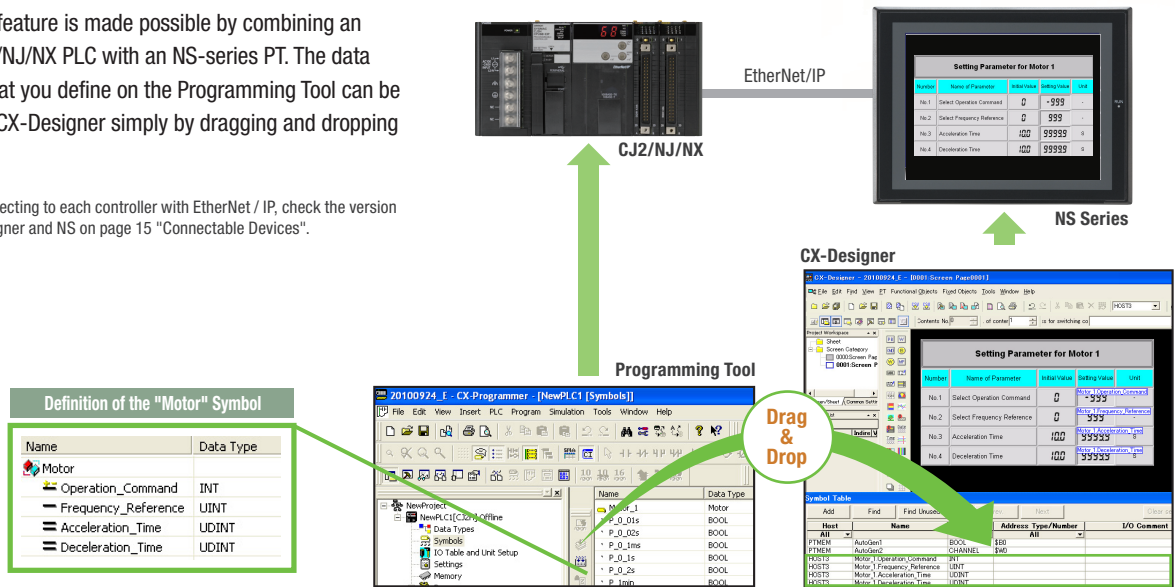

Tag access

A tag is a name given to an address. Tags are managed in the CJ2 CPU Unit, where they are defined as network symbols. The common user-defined tag names are used from Programmable Terminals and host applications to access memory in a CJ2 CPU Unit without knowing the physical address.

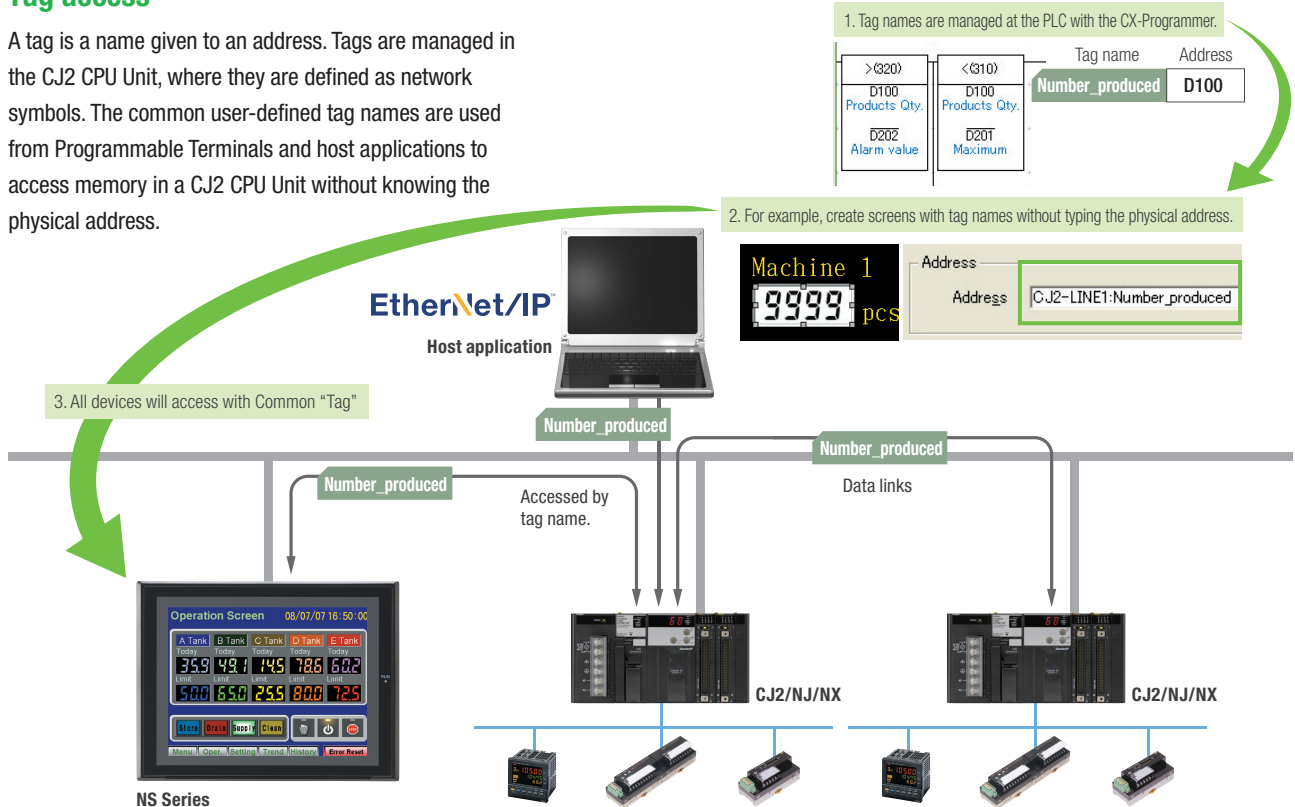



Simultaneous and parallel engineering

The host applications can be designed using the tag names of the PLC and PT. Parallel development will shorten the design time.

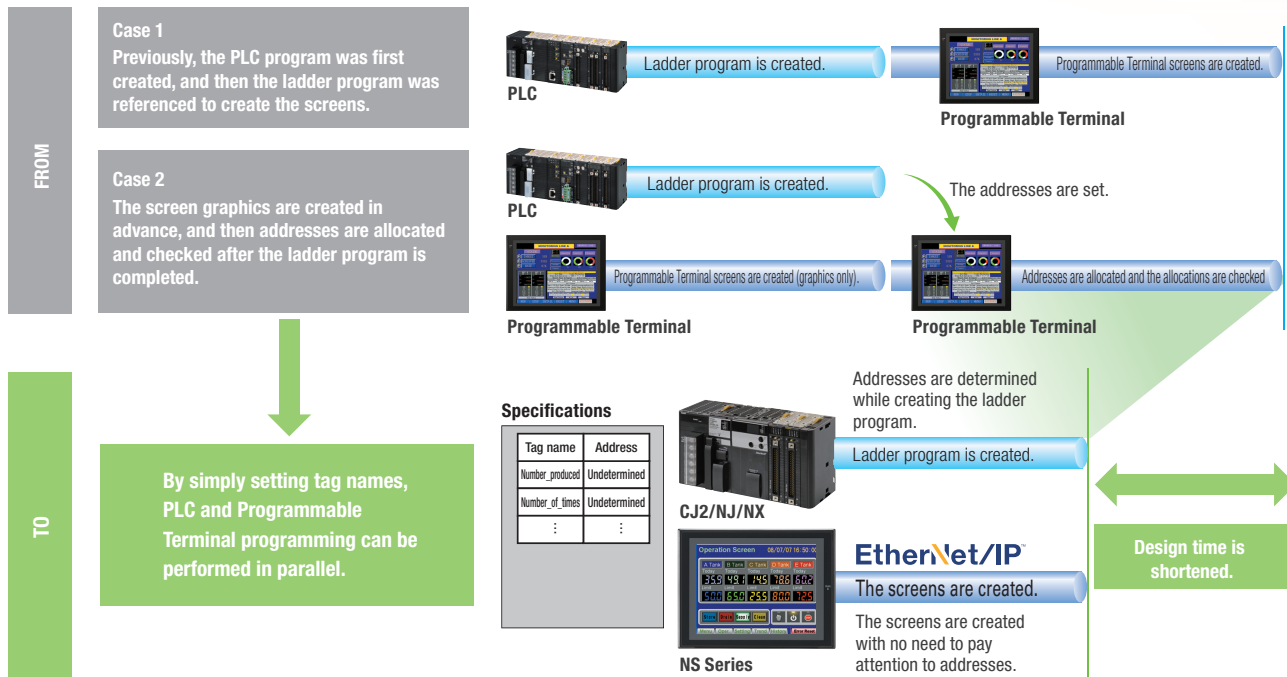

Minimize side effect of address changes

It is possible to access memory with tags, so the PT and host application are not affected even if the address of data in the PLC is changed.

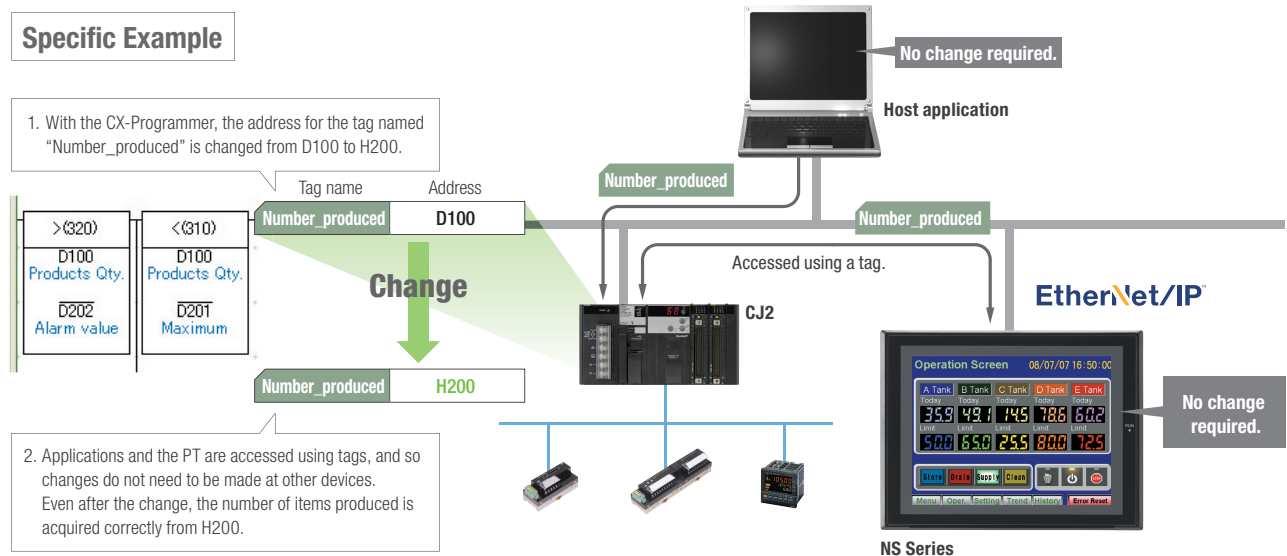

Direct Connection to Temperature Controllers

Connect OMRON Temperature Controllers directly to the NS-series PT.

OMRON Temperature Controllers can be connected directly to the NS-series PT's RS-232C port. Data does not pass through the PLC, so ladder programming is not required. Also, there are plenty of objects in the SAP Library for Temperature Controllers, and Temperature Controller screens can be created easily just by pasting objects from the SAP Library to the screens.

Note: An RS-422A Serial Adapter is needed to connect directly to a Temperature Controller. Refer to page 53 for a list of the Temperature Controllers that can be connected. A Conversion Unit is not required to connect to the RS-422A/485 serial interface of the NS15.

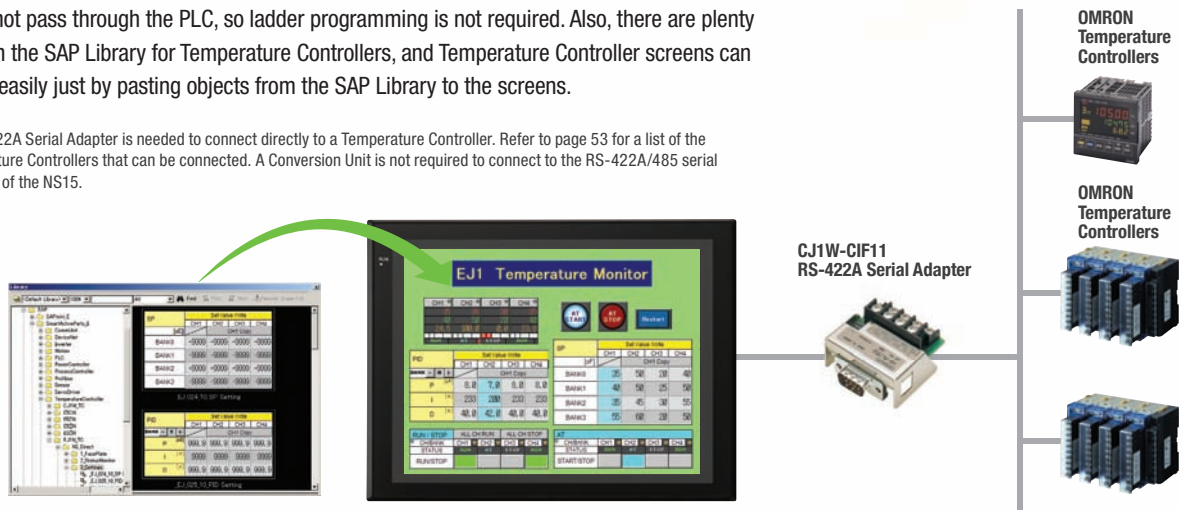

Face Plate Auto-Builder for NS

Screens for Loop Controllers can be easily and automatically created.

Significantly reduces the effort required to combine a Loop Controller with an NS-series PT.

Easy automatic generation of faceplates, such as faceplates for PV monitoring and SV setting, as well as tuning screens, such as screens to set and autotune PID constants.

A total of 17 function blocks are supported, with eleven function blocks, such as Ratio Setting and Motor Manipulators newly supported (version 3 of higher).

Comments are automatically entered for automatically assigned unit and scale settings when a project is generated (version 3 and higher).



CX-Process Tool
(Loop Controller Programming Software)
 ● Loop Controller program creation (function block method)
 ● CSV tag file output

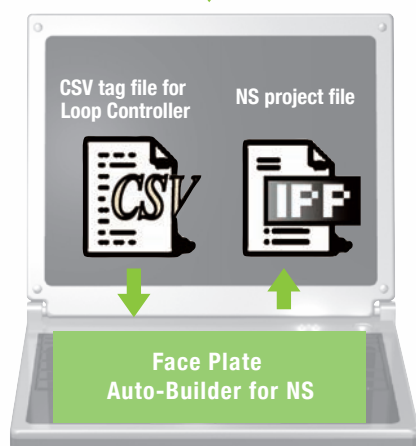

Created screens are easily transferred to the NS by using a Memory Card or over the network.



CX-Designer
(NS screen creation software)
 ● Editing created data
 ● Creation of other required screens

Note: Refer to the PLC-based Process Control Catalog (Cat. No. P051) and the Loop-control CPU Unit Catalog (Cat. No. R128) for details on Loop Controllers.

Multi-language Support

Support 42 languages and switch the language of the labels among up to 16 languages.

Unicode is supported and 42 Asian and European languages can be combined in screens. Also, it is possible to switch between up to 16 labels using the label switching function, so it is possible to support up to 16 languages in a single screen just by specifying the language to be displayed in each label.

NS Series



Multi-language CSV data

Setting Screen	設定画面	설정 화면	Einstellung Des Schirms
Monitoring Menu	監視メニュー	모니터링 메뉴	Überwachung Des Menüs
TARGET	目標	목표	ZIEL
ALARM MAIL	警報メール	경보 메일	WARNUNG MAILING
ALARM MENU	警報メニュー	경보 메뉴	WARNUNG MENUE
OPERATION QUANTITY	稼働量	작업량	BETRIEB QUANTITÄT
MANUAL OPERATION	手動稼働	수동작업	HANDBETRIEB
OPERATION MAX	稼働量上限	작업량상한	BETRIEB MAXIMUM
OPERATION MIN	稼働량下限	작업량하한	BETRIEB MINIMUM
Pulse	펄스	Impuls	
Pulse	펄스	펄스	Impuls
Pulse	펄스	펄스	Impuls
Pulse	펄스	펄스	Impuls
Pulse	펄스	펄스	Impuls
Pulse	펄스	펄스	Impuls
Pulse	펄스	펄스	Impuls
Pulse	펄스	펄스	Impuls
STOP	정지	정지	STOP
AUTO/MANUAL	자동/수동	자동/수동	AUTO/MANUELL
INITIALIZE	재설정	재설정	INITIALISIEREN

The labels' text attributes can also be reflected when importing.

When screen data is imported, text attributes can be applied to the specified labels and attributes such as the font and text color can be reflected to other languages labels.

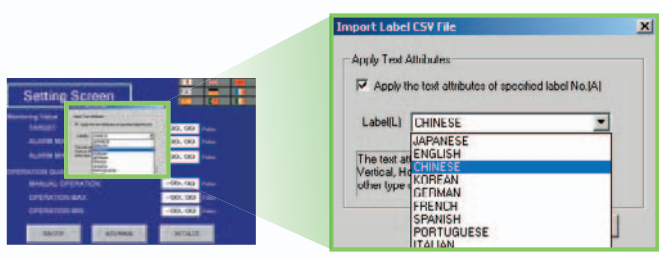

Multi-language conversion has become much easier.

The screen data in the source language is exported to a CSV file and sent to a translation agency by e-mail for translation. Later, the translated CSV file is just imported to easily provide multi-language support.

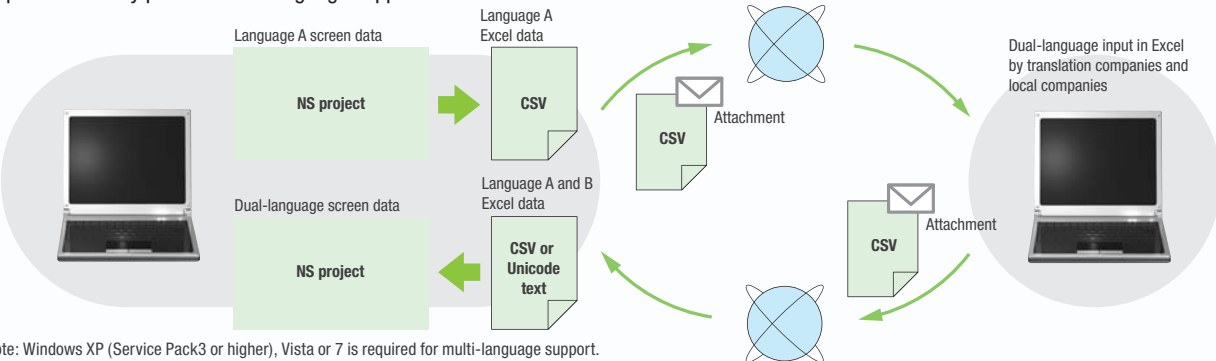

Note: Windows XP (Service Pack3 or higher), Vista or 7 is required for multi-language support.

Multi-language System Messages. Eight Languages Supported as Standard Feature

The system program of NS-series PTs supports Chinese and European languages. All eight languages are a standard feature, including Chinese (traditional and simplified), Spanish, Italian, German, and French, in addition to the previous Japanese and English. Along with maintenance menus, messages for communications errors, communications settings, and screen transfers can be displayed in any of eight languages. Maintenance can be performed in the desired language. The language can be easily set using the NS-series PT or screen data.

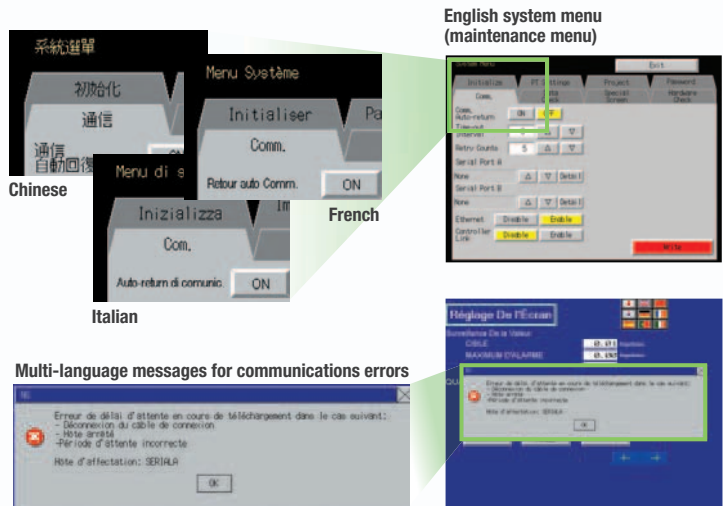

Multifunction Objects

Execute up to 32 functions with one Multifunction Object
Multifunction Objects support Write Bit, Write Word, object control, and etc

Multifunction Objects combine the functions of multiple objects into one object. Multiple functions can be executed by pressing one button without using troublesome macros. Setup is easy. For example, a setting can be made on-screen using the Support Software to turn ON a bit to start a machine, set a value, and then change the screen.

Easy On-screen Setup with Support Software!

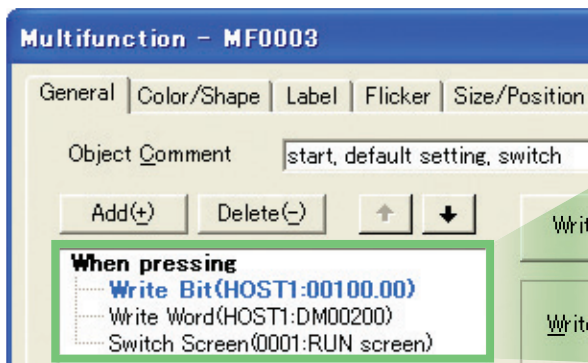

Multifunction execution with one object



Integration



Execute multiple functions with one button.

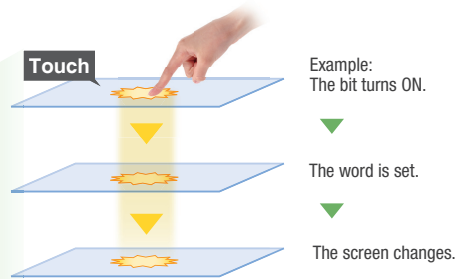

Multifunction Objects support four useful functions

Switches that do not immediately operate when touched can be easily made without ladder programming.

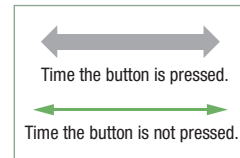

ON delay Turns ON when the button is pressed for at least a specified time.

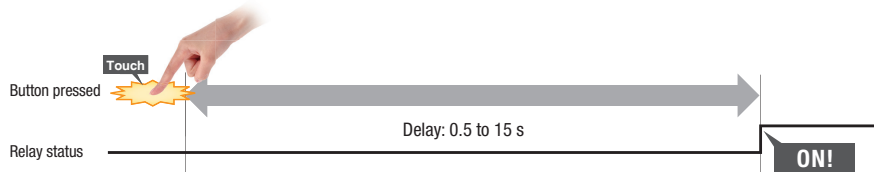

Double-press Turns ON when the button is pressed twice within the specified time.

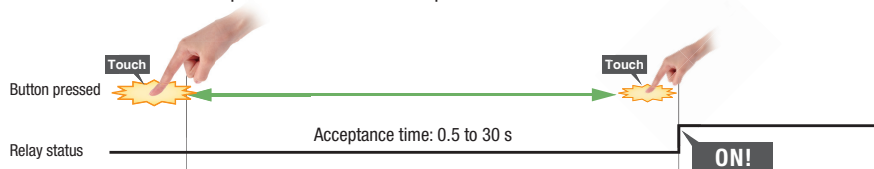

Simultaneous pressing prohibited Does not turn ON when the button is pressed at the same time as another button.

OFF delay Turns OFF after a specified time lapses after the button is released.

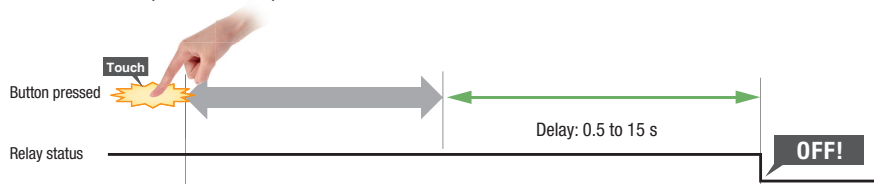

Plentiful Graphing Functions

Data Log Graph (Trend Graph)

Up to 128 data can be collected in the cycle of 500ms. Logging data is stored as a CSV file in the Memory Card inserted in the NS-series PT.

Logging data is stored as a CSV file in the Memory Card mounted in the NS-series PT. The data stored in the Memory Card can be read or deleted from the screen.

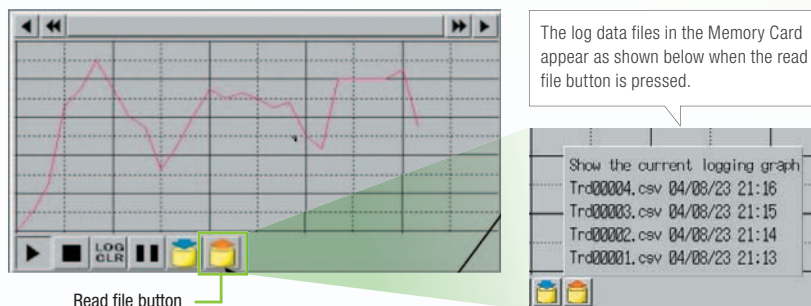

A log can be saved automatically, without any programming, just by selecting the Save the data periodically Option in the Data Log Setting Window.

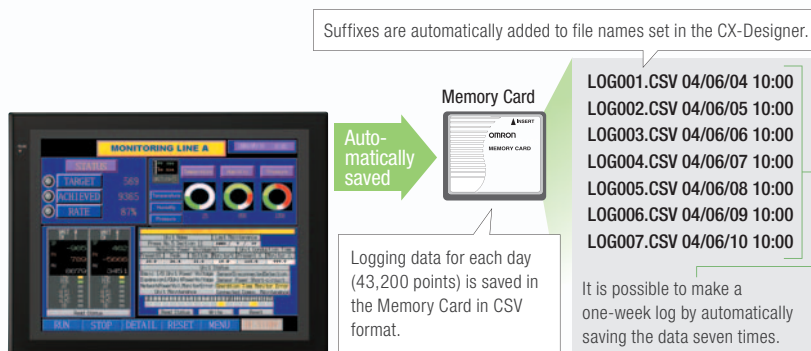

Line Graph Function

The data logged by the PLC can be displayed in overlapping graphs, so a device's operation can be compared for evaluation and analysis. In addition, up to 1,000 words of consecutive data can be displayed as a line graph, data can be displayed together, and any region can be magnified.

(1) Graphs can be superimposed.

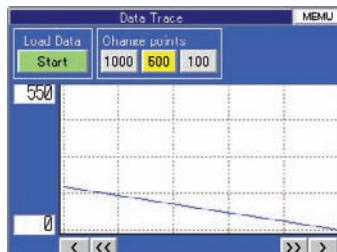

(2) The display can be magnified.

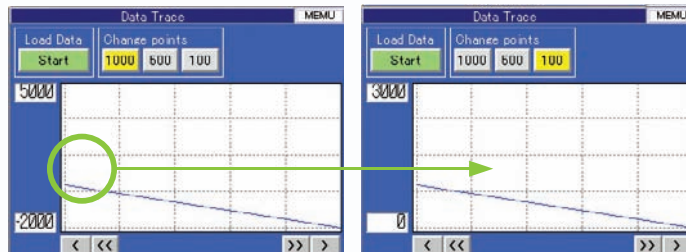

Continuous Line Function

Any position from the host (PLC) can be plotted as a graph. A graph can be plotted in any position by specifying the X and Y coordinates of the vertices. Also, the graph can be moved on the screen by specifying the movements from the PLC.

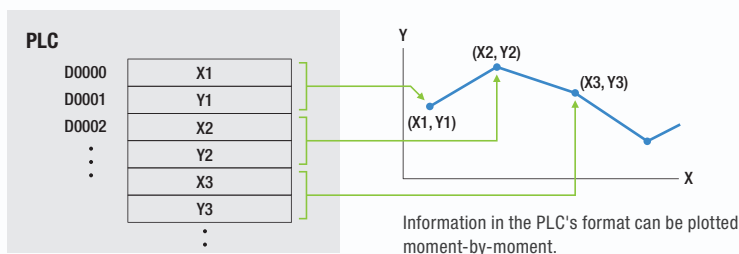

Design

Screen Data Security Functions

Protect important screen data with a password.

If password protection is set in the data transfer security settings when the screen data is designed, a password must be entered to download or upload the screen data, so important screen data can be protected.



If a password has been set, the password is required to transfer screen data (download or upload) with the Memory Card.

Security password

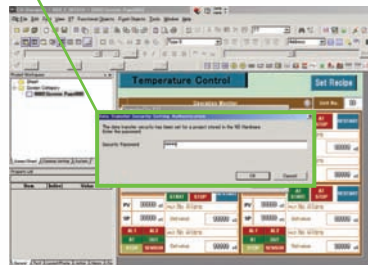

A password between 4 and 64 characters long can be set. The download/upload will start if the user inputs the password that was set when the screen was designed. (Password input will be disabled if the wrong password is input 3 times in a row.)



Device Data Transfer

Easy Data Exchange between the PLC and Components

For example, temperature controller alarm values can be transferred to the DM Area of the PLC's CPU Unit. No communications programming or macros are required.

Multi-vendor Support

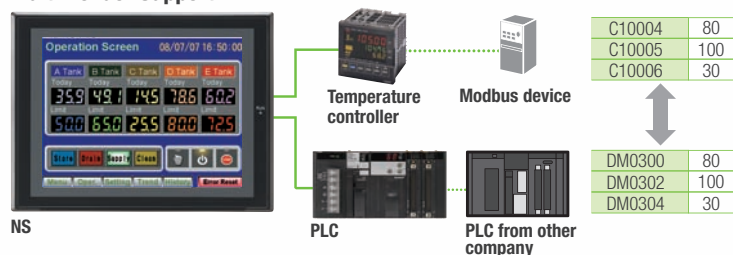

Multi-vendor Support

Devices from multiple vendors are supported. Data can be easily exchanged with PLCs from other companies and Modbus devices.

Easy Settings

To make the settings, simply specify the device and addresses of the transfer source and transfer destination in the CX-Designer. Settings can be made using the same procedure as for setting the addresses for normal components.

Easy Settings

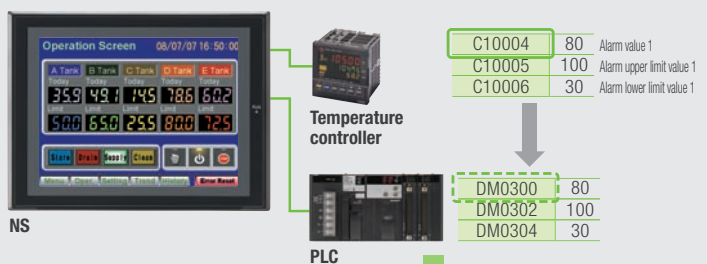

CX-Designer Select Device Data Transfer Setting from the PT Menu.

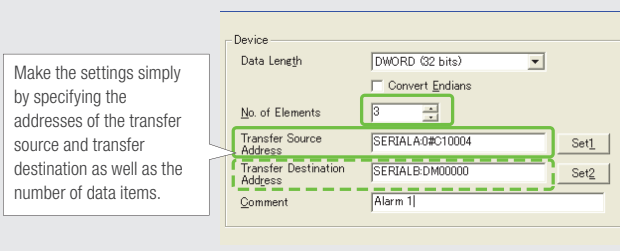

Make the settings simply by specifying the addresses of the transfer source and transfer destination as well as the number of data items.

Note 1: EtherNet/IP tags are not supported.

Note 2: CX-Designer version 3.1 or higher is required.

NS system version 8.2 or higher is required.



NS Screen Templates

The CX-Designer of version 3.5 or higher provides the palette to display objects and templates. Refer to the next page for details of the palette.

Even Simpler

Templates can be read into the screen by just dragging and dropping thumbnails displayed on the palette.

The template consisting of multiple screens allows multiple screens to be read by dragging and dropping it once.

The Address Setting Dialog Box that is displayed to read templates is useful for changing addresses all at once.

Easy Reading from Palette

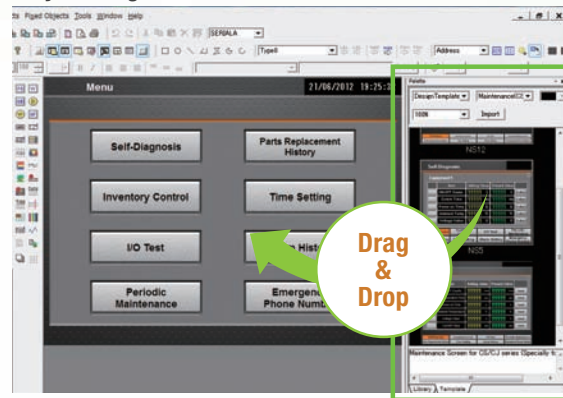

Address Setting Dialog Box

Palette

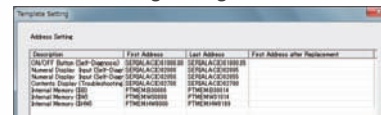

Even More Beautiful

The refined templates enable you to use the NS Series with the screens that have a sense of unity in design.

Three different types of templates besides default screens are provided. The design can be changed easily with "Theme Name" that is displayed when dragging and dropping.

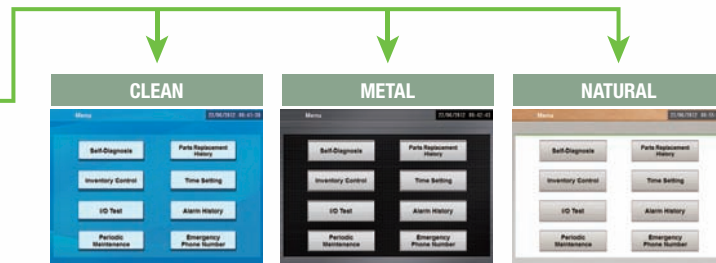
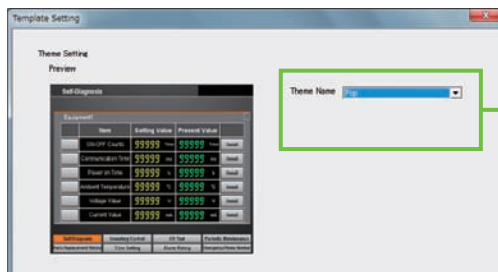
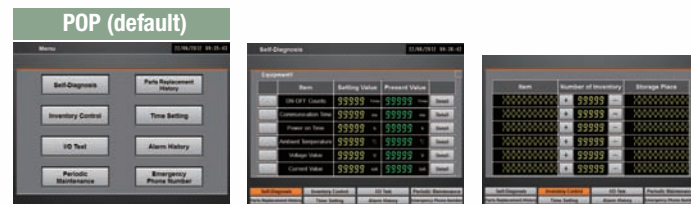

"Cool" Objects

Backgrounds, buttons, labels, message boxes, and other objects are also provided for various themes.

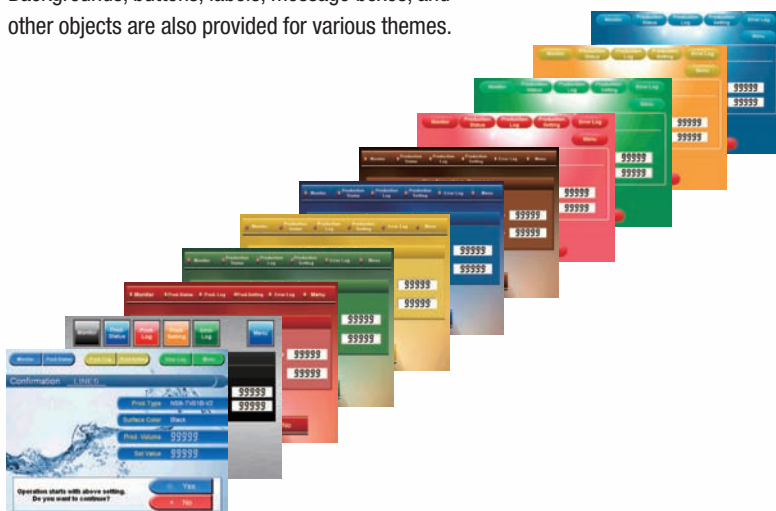

CX-Designer, Screen Design Software

User-friendly Screen Creation

Without screen creation and ladder programming, the CX-Designer Screen Design Software is so easy-to-use that anyone can master it. Quickly create the required screen by dragging and dropping objects. OMRON's unified development environment lets you drastically reduce the work required to create screens.

Note: The same type of Project Workspace and Output Window as in the CX-Programmer are provided for the user interface.

All addresses and comments can be managed using a single Symbol Table.

Shows a list of addresses, names, and comments used in project screen data. Addresses, names, and I/O comments for the CX-Programmer can also be imported.

Host	Name	Type	Address	Type/Number	I/O Comment	Tag
All	All	All			All	
H0ST3	STOP	BOOL			STOP SWITCH	Network Variable
H0ST3	RUN	BOOL			RUN SWITCH	Network Variable
H0ST3	AutoGen0	CHANNEL	00000			None
SERIALA	LEFT	BOOL	0000.01		LEFT SWITCH	None
SERIALA	RIGHT	BOOL	0000.00		RIGHT SWITCH	None
SERIALA	AUTO	BOOL	000000.00		AUTO SWITCH	None
SERIALA	PARK	BOOL	00000.00		PARKING	None
PTMEM	AutoGen2	CHANNEL	840			None
PTMEM	AutoGen1	BOOL	880			None

Improved Icons and Help

Objects and templates can be selected easily from the palette.

Easy-to-use, well-designed, and super-beautiful objects and templates can be read into the screen by dragging and dropping. Templates can be chosen from four different designs.

Page	ID	Host	Name	Address	I/O Comment	Label	Object Comment	Detailed Information
0001	PEC0063	SERIALA	AutoGen1	DM10207				Command Button : Macro : Touch OFF Timing
0001	NUM0019	SERIALA	AutoGen1	DM10207				Numerical Display & Input : Address
0010	NUM0607	SERIALA	AutoGen1	DM10207				Numerical Display & Input : Address
0012	NUM0074	SERIALA	AutoGen1	DM10207				Numerical Display & Input : Address

The project Workspace enables the user to look through the entire project.

- Screens you want to edit can be opened right away.
- Perform screen management, such as copying or deleting screens, by simply right-clicking.
- Reusing screens from other projects is easy with the CX-Designer.
- Settings for alarms, data logs, communications, and other functions can be easily accessed.

Drastically reduce the number of clicks in the project.

Just click on the object once to display or change properties. Multiple objects can be selected to display and change shared properties all at once.

The Output Window shows search results.

In addition to addresses and I/O comments used in screen data, labels can also be used as search strings and the results can be displayed.

Palette

Switches, lamps, and templates are registered in the palette.
Just drag and drop them on the new or existing screen to add.

Note. CX-Designer version 3.5 or higher is required.

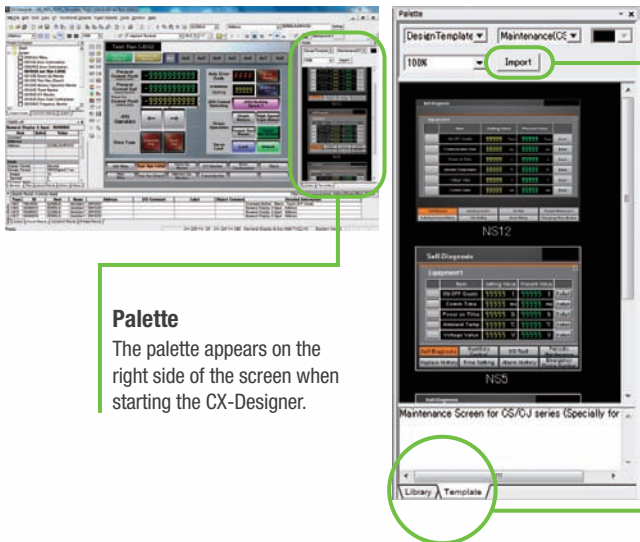

Palette

The palette appears on the right side of the screen when starting the CX-Designer.

Import

The Import button allows new objects and templates to be added to the palette.

Library

Parts list of switches and lamps is displayed.

Template

Templates are displayed in thumbnail form.

Library

Switches and lamps are registered in the library. Select a switch, lamp, or other object from the pull-down menu. You can register switches you created or other objects you often use in "User-defined".

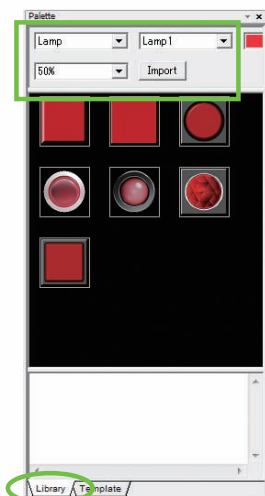

Color Setting

Display colors of objects registered in the library can be changed easily by selecting colors from pull-down menus.

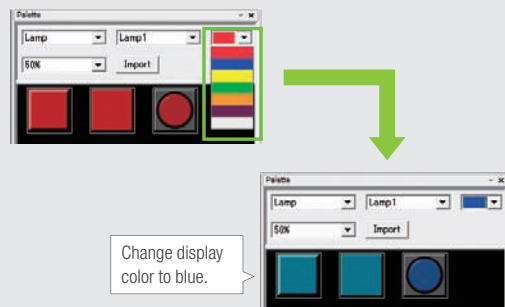

Template

Templates include design templates and device templates.

• Design Template

Design templates are the screen templates designed professionally. Addresses can be changed with "Address Setting Dialog Box".

• Device Template

As well as SAP (Smart Active Parts), addresses on the screen are automatically updated by changing unit number of Temperature Controller or Special I/O Unit with "Unit No Dialog Box".



A template consists of multiple screens. Multiple screens are pasted on the screen by dragging and dropping a thumbnail on the screen.

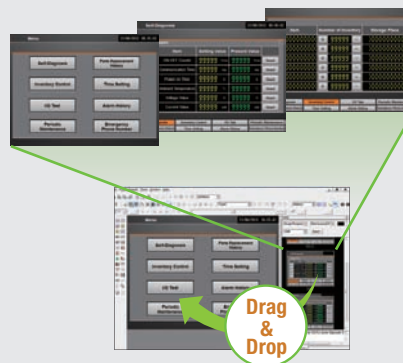

Design

Reading Another Project's Screens and Objects

Resources from another project can be easily reused by just selecting the screen or objects that you want to read and dragging and dropping it, so screens can be created intuitively.

Example screen 1 Select the screen that you want to read, drag it to the destination, and drop it.

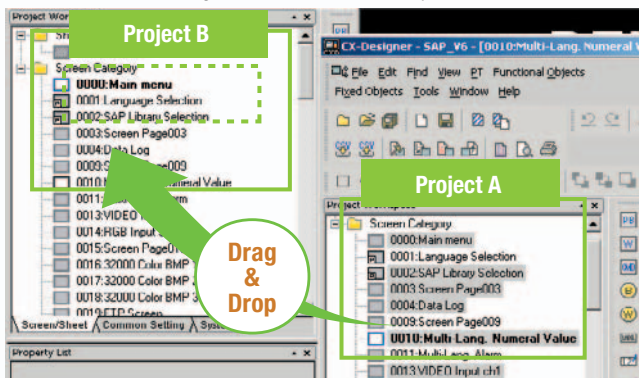

Example screen 2 Select the part that you want to read, drag it to the destination, and drop it.

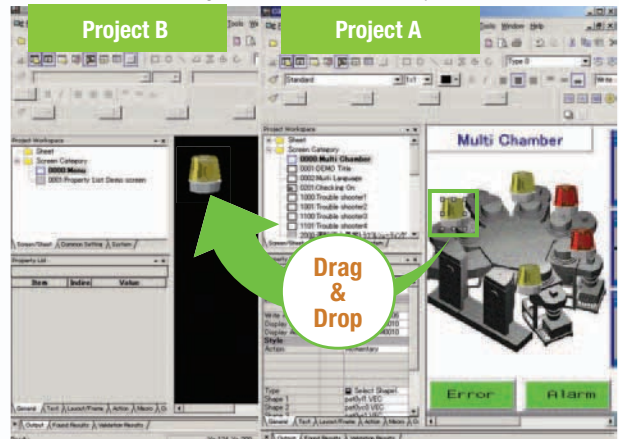

Reading CAD Files

It is possible to import DXF files by dragging and dropping them. The files are read as a diagram, and so less capacity is used than with images. It is also easy to customize the diagram by changing the shape or color.

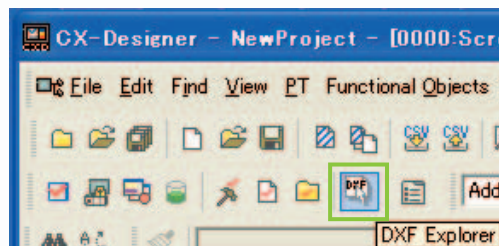

The screen data and ladder program can be checked simultaneously in the computer.

The CX-Designer and CX-Programmer interconnects the test functions in the computer through the CX-Simulator. The screens and ladder program checks are performed simultaneously, which significantly increases debugging efficiency. The CX-Programmer also has a new button for integrated simulation. And, work efficiency is further improved with the ability to keep required work screens pinned on front and to zoom in or out as desired.

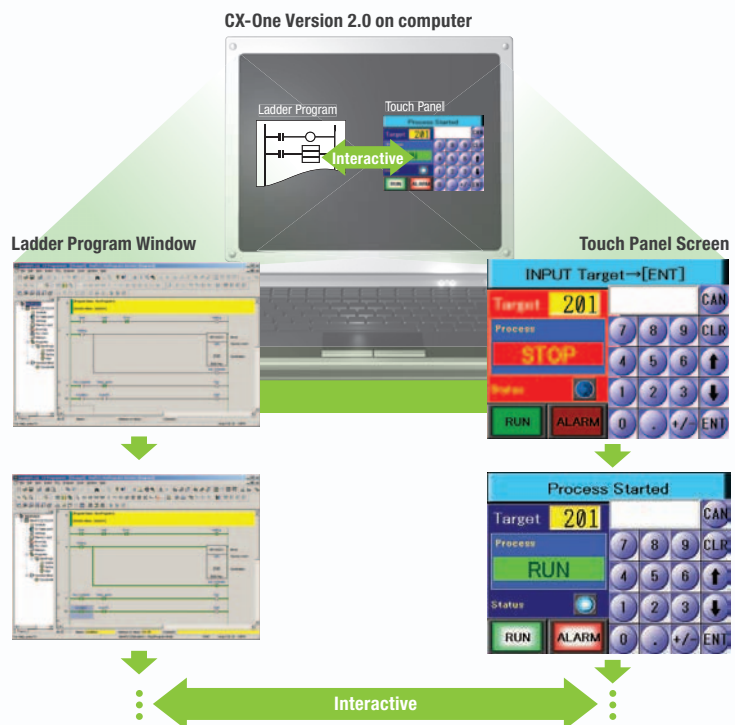



Reading the Symbol Table

The symbol table created in the CX-Programmer during ladder programming can be read into the CX-Designer by dragging and dropping, so it isn't necessary to manually data such as input addresses and I/O comments. Tags (i.e., network symbols) can also be read into the CX-Designer.

Note: Version 8.0 or higher of the CX-Programmer support tags (i.e., network symbols).

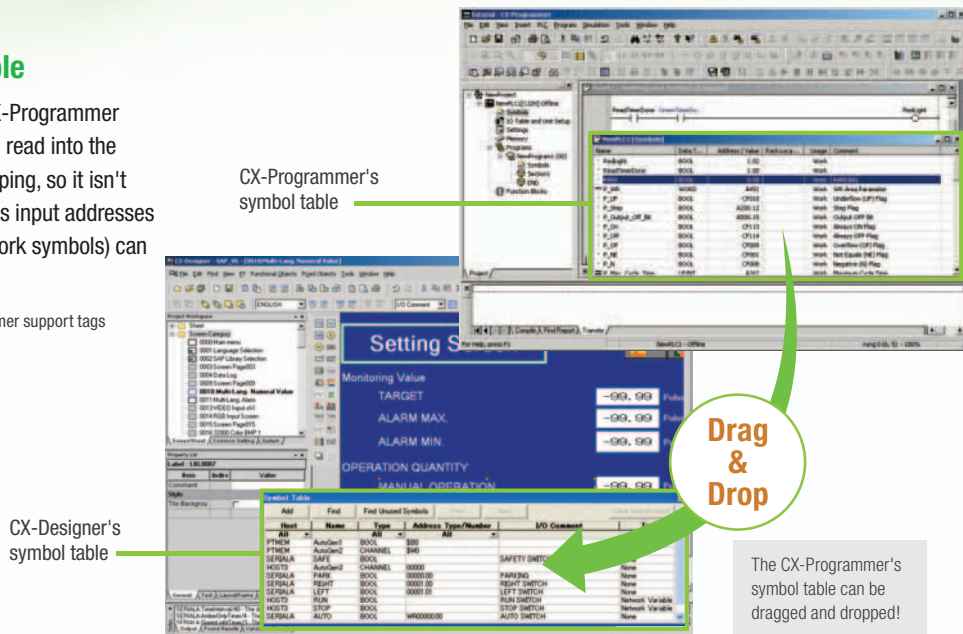

Example of Reading the Symbol Table

The symbol table read from the CX-Programmer can be directly dragged and dropped to the touch switch and lamp.

(1) Create a switch on the screen.



(3) Allocations for buttons and lamps can also be checked on the screen using comments imported from the CX-Programmer.

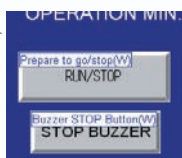

Example of Easy Address Allocation

(2) Check the comment then drag-and-drop the symbol from the symbol table to the property list.

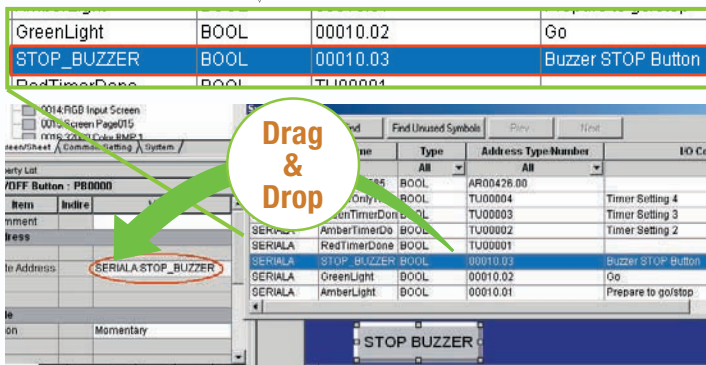

Example of Reading I/O Comments

If Use I/O comment is selected in advance for the Use symbol text as label, the I/O comments are automatically used as labels when addresses are dragged and dropped from the symbol table. (If Use symbol names is selected, the symbol names are used as the labels.)

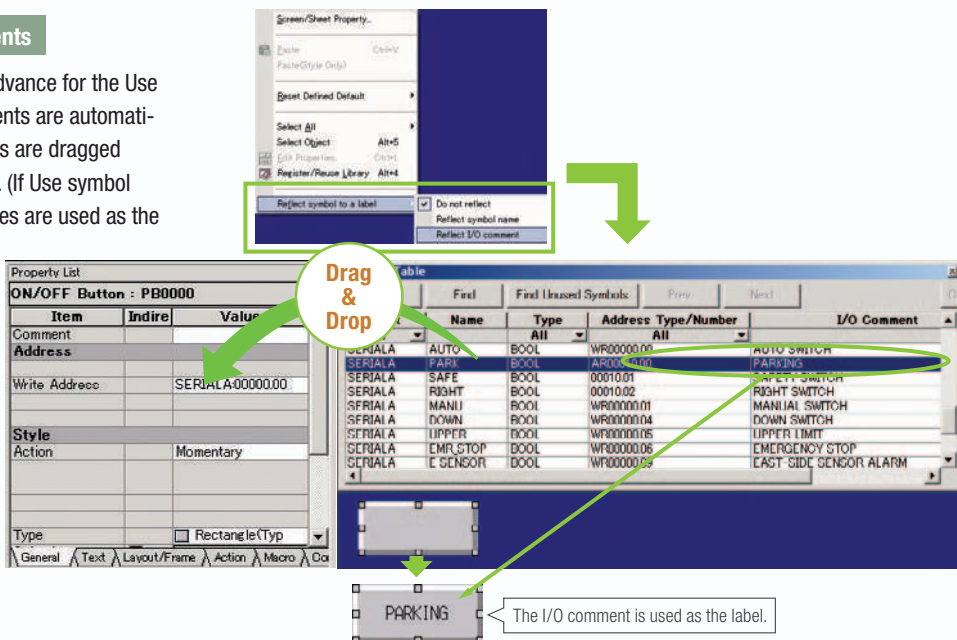

Startup/Operation

260,000-color Video Display

Equipment and workpiece movements can also be displayed in beautiful video

NS-CA001 Video Input Unit

Four video inputs or CCD cameras can be connected and up to four images can be displayed simultaneously if the image size is 320x240 pixels. The NS-CA001 cannot be used with the NS5 or the NS15.

NS-CA002 RGB/Video Input Unit

There is an analog RGB input terminal in addition to the two video input terminals. Either of the video signals or the analog RGB signal can be displayed on the NS-series PT. The NS-CA002 cannot be used with the NS5.

Note: Video input cannot be used with the NS15.
Only RGB input can be used.

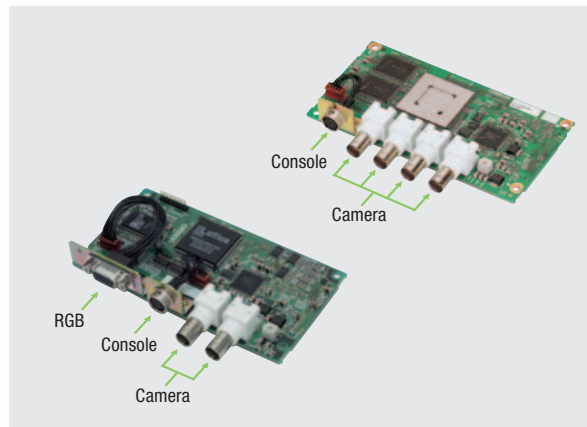

Also Compatible with OMRON Vision Sensors.

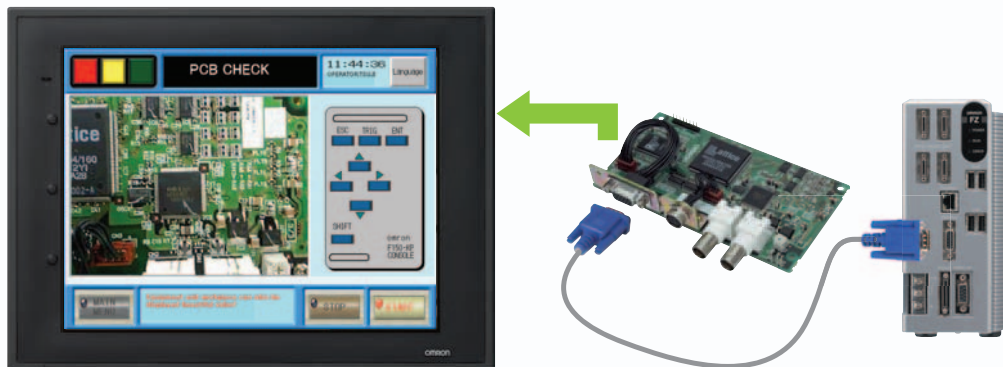

Analog RGB Output

The NS screen is seen by another monitor.

The NS15 screen (XGA) can be displayed on an on-site display that has RGB inputs.

Note: Only NS15





FTP Function

You can partially replace text and pictures from your computer.

FTP (File Transfer Protocol) has been added! Texts, lists, and recipes can be replaced with the put/get command from your computer! You can even replace BMP files from your computer easily.

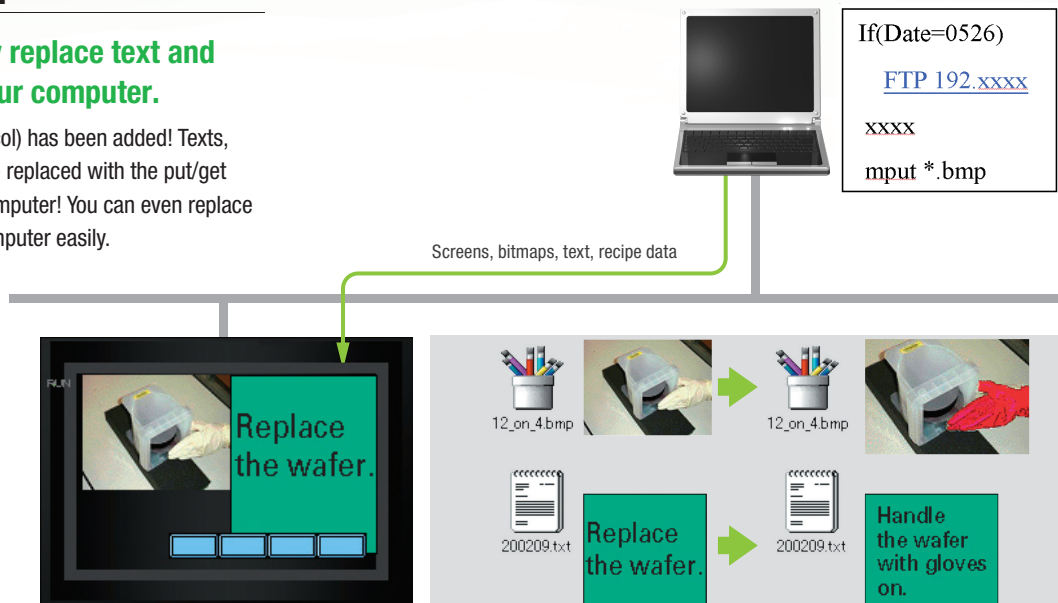

User Security Functions

Operator access rights and the operating format can be set to one of five password levels.

Each operator can be given one of 5 password levels using the User Security (level authentication) function. A password level can be set for each object, so various objects can be made inoperable or hidden based on the operator's access level.

Level	Access Rights
Level1	Line Operator
Level2	Group Leader
Level3	Line Manager
Level4	Maintenance
Level5	Administrator

Low Level 1
Level 2
Level 3
Level 4
High Level 5

Operator passwords are managed in 5 levels. Passwords can be up to 16 characters long and the access rights increase as the level number increases.

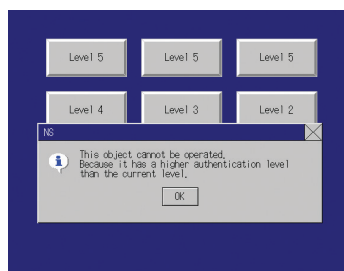

The operator cannot manipulate objects with a password level (authentication level) higher than the operator's login level.

LED backlight

NS5 color-type models (SQ/TQ models), NS8 models, NS10 models, NS12 models, NS15 models with LED backlight are newly released.*

LED backlight allows backlight brightness adjustment of up to 32 levels. The brightness can be adjusted from the operation screens, and the RUN indicator changes its luminance according to the settings of the backlight brightness; it is favorable for ship and vessel applications.

* LotNo.1520 or later of NS5 color-type models, LotNo.28X1 or later of NS8 models, LotNo.11Y1 or later of NS10 models, LotNo.14Z1 or later of NS12 models, LotNo.31114K or later of NS15 models.

Conventional three-level adjustment

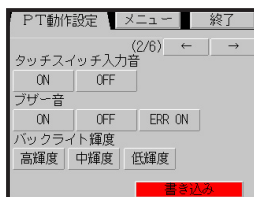

New 32-level adjustment



Maintenance

Comparison

The on-site NS screen can be compared with the computer screen.

The comparison function of the CX-Designer enables the following comparison.

CX-Designer project ↔ Project in the computer

CX-Designer project ↔ NS project

- Same ▶ Same in screen
- Different ▶ Different in screen
- Added ▶ Screen added
- Deleted ▶ Screen deleted

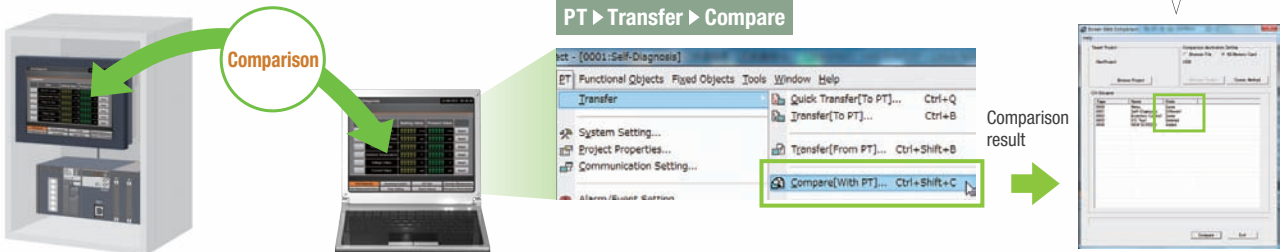

Single Port Multi Access (SPMA)

Note: Communications across network layers can be performed.

Transfer ladder program data to the PLC via the PT. Perform online editing via the PT.

[Computer (Serial/USB) → NS-series PT (Ethernet) → PLC (Ethernet or Controller Link) → PLC]

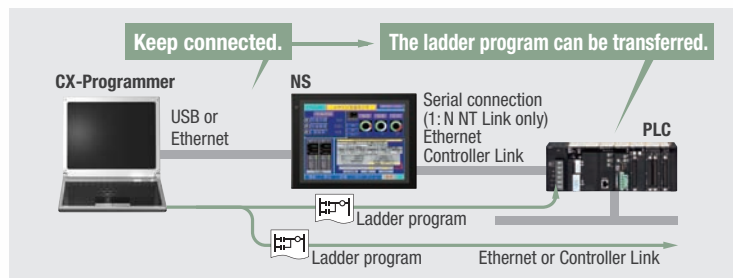

Transfer screen data via the PLC.

[Computer (Serial) → PLC (Ethernet or Controller Link) → NS-series PT]

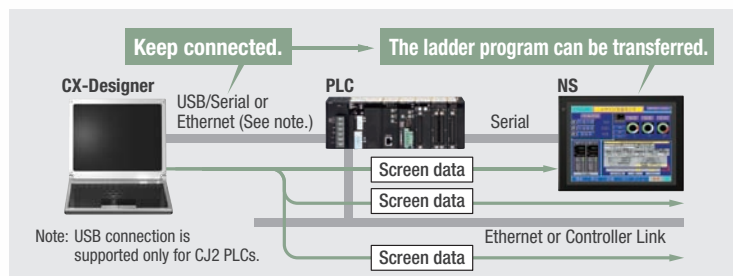

Using a USB relay cable greatly improves debugging at equipment startup.

Use a USB relay cable to enable performing maintenance from in front of the control panel.

Easy Automatic Connection

A search is automatically made for the PLCs connected to the PT and the results are displayed using the automatic online connection function in the CX-Programmer. Just select a PLC from the list to connect. This function is also supported for PLCs over network layers.

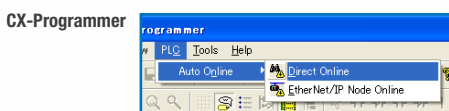
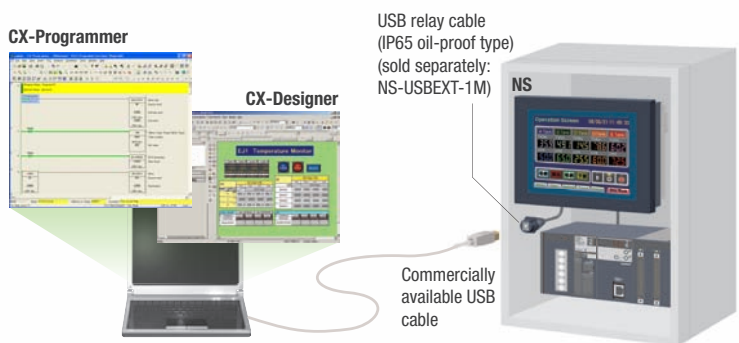

Note 1: SPMA can be used in CS/CJ-series PLCs with lot number 030201 or later.

Note 2: SPMA via a PLC is not supported when a CP-series PLC is connected. (SPMA via an NS-series PT is supported with a CP-series PLC.)

Note 3: CX-Programmer version 8.2 and higher support automatic online connection via the PT. NS system version 8.2 or higher is required.

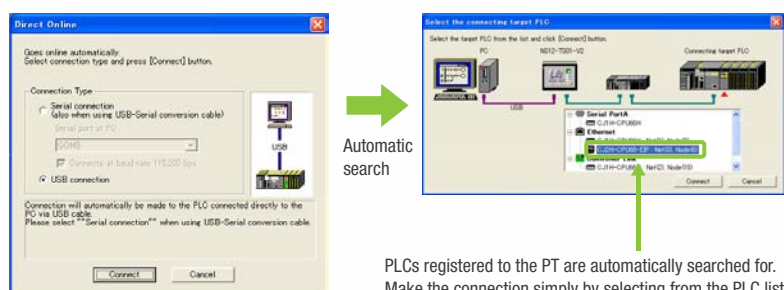

PLCs registered to the PT are automatically searched for. Make the connection simply by selecting from the PLC list.



PLC Data Trace

The PLC data trace function can be used without a computer.

The PLC Data Trace function is built into the PT in addition to the Ladder Monitor and Device Monitor. A bit's status and operation can be viewed in a time chart just by setting the desired PLC bit's address in the PT. It is also now possible to display word data, save data in CSV files, and save time chart screens in BMP files.

Note 1: There are differences between this Data Trace function and the CX-Programmer's Data Trace function. Refer to the NS-series Programmable Terminal Programming Manual (Cat. No. V073) for details.

Note 2: The PLC data trace function cannot be used with the 5.7-inch model.

Note 3: The PLC data trace function is not supported for connection with a CP1E PLC.

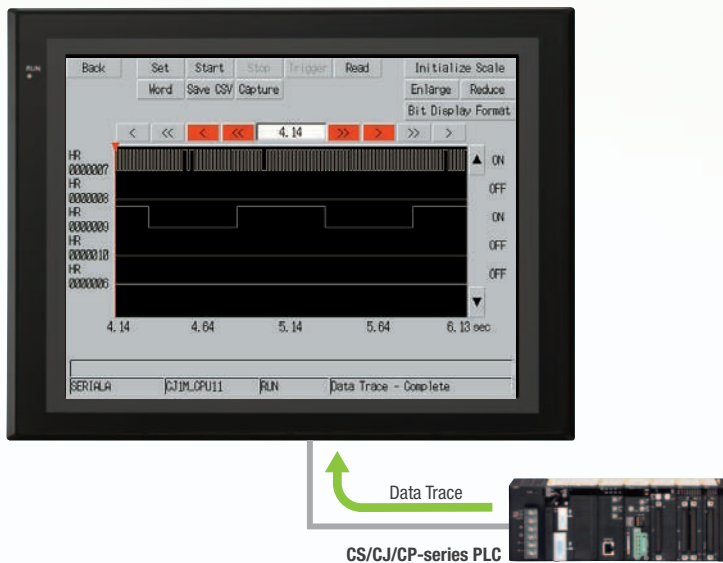

Operating log

What Was Touched When? can be recorded.

Functionality has been improved with the addition of a log to record operators' use of the panels. It is now possible to record and display the time, date, and operation details for buttons (i.e., hardware switches) pressed on the control panel in addition to operations on the touch panel. The operation log can be saved in a CSV file on a Memory Card mounted in the NS-series PT.

2008/07/07 15:50:09 Ope. Start button Page:0000 Obj ID:0007 Touch ON t

Title of Occurrence	History Type	Message	Item1	Item2	Item3
2008/07/07 15:50:05 Ope.	Start button	Start button	Page:0000	Obj ID:0007	Touch ON t
2008/07/07 15:50:06 Macro	Start button	Start button	Page:0000	Obj ID:0007	Touch OFF
2008/07/07 15:50:06 Macro	When chang	When chang	Page:0000	Obj ID:0000	When chang
2008/07/07 15:50:07 Macro	When chang	When chang	Page:0000	Obj ID:0000	When chang
2008/07/07 15:50:08 Ope.	Stop button	Stop button	Page:0000	Obj ID:0000	Touch ON t
2008/07/07 15:50:08 Ope.	Stop button	Stop button	Page:0000	Obj ID:0000	Touch OFF
2008/07/07 15:50:09 Macro	When chang	When chang	Page:0000	Obj ID:0000	When chang
2008/07/07 15:50:09 Ope.	Start button	Start button	Page:0000	Obj ID:0007	Touch ON t
2008/07/07 15:50:10 Ope.	Start button	Start button	Page:0000	Obj ID:0007	Touch OFF
2008/07/07 15:50:10 Macro	When chang	When chang	Page:0000	Obj ID:0000	When chang
2008/07/07 15:50:11 Macro	When chang	When chang	Page:0000	Obj ID:0000	When chang
2008/07/07 15:50:12 Macro	When chang	When chang	Page:0000	Obj ID:0000	When chang
2008/07/07 15:50:13 Macro	When chang	When chang	Page:0000	Obj ID:0000	When chang
2008/07/07 15:51:01 Macro	When chang	When chang	Page:0000	Obj ID:0000	When chang
2008/07/07 15:51:02 Ope.	Stop button	Stop button	Page:0000	Obj ID:0000	Touch ON t
2008/07/07 15:51:03 Ope.	Stop button	Stop button	Page:0000	Obj ID:0000	Touch OFF
2008/07/07 15:51:03 Macro	When chang	When chang	Page:0000	Obj ID:0000	When chang

Multiple operation log files can be saved on a Memory Card with date and time data.

Memory Card

Operat_080520_173000.csv
 Operat_080521_173000.csv
 Operat_080522_173000.csv

The files can be opened in Excel.

	A	B	C	D	E	F
1	Date&Time	O	Message	Page	ID	Event
2	Date&Time	P	Message	OldPage	NewPage	
3	Date&Time	M	Message	Page	ID	Event
4	Date&Time	A	Message	Host	Address	Event
5	2008/7/7 15:49 M			PO	ID0	EV25
6	2008/7/7 15:49 O		Stop button	PO	ID0	EV20
7	2008/7/7 15:49 M			PO	ID0	EV25
8	2008/7/7 15:49 O		Stop button	PO	ID0	EV21

Switch directly from the user screen to the log operation display screen.

For example, with a control panel comprised of the NS-series PT, hardware switches, and an emergency stop button, you can even record and display operation of the emergency stop button.

A comment of up to 32 characters can be set and displayed for each operation to provide easy-to-understand information about what type of operation was performed.

Maintenance

Ladder Monitor

The ladder program can be monitored without a computer.

Ladder programs with I/O comments can be monitored on the PT's screen and the ladder program can also be edited with the Programming Console function.

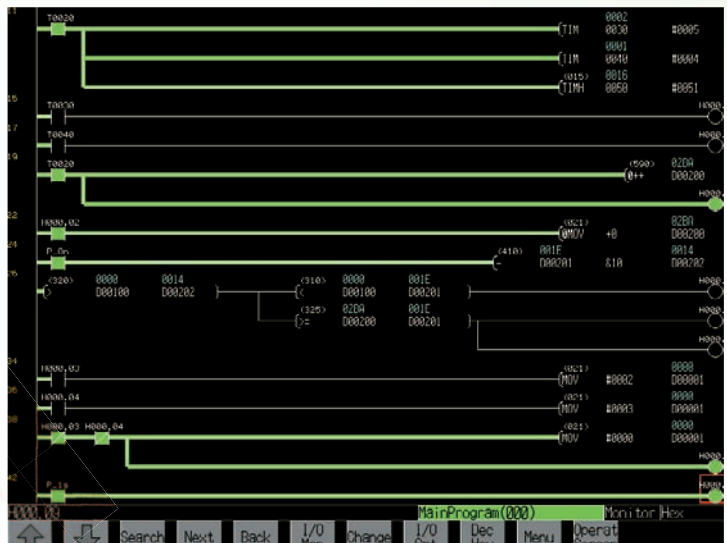
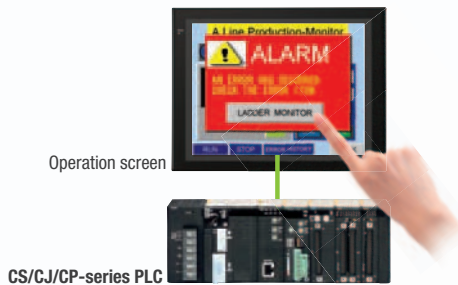

Also meets the requirements of users who need to display devices onsite

Switch Box Function

The operator can check the PLC status by displaying just the I/O comments and status.

Device Monitor Function

Displays the device's contents, allowing settings to be input and checked and making startup operations more efficient.

Switch Box Function

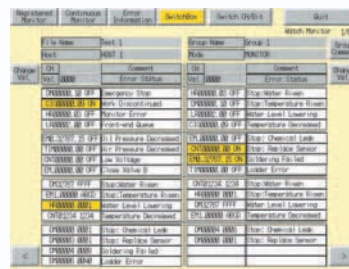

Device Monitor Function

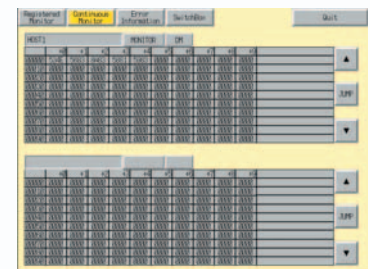

so no extra work to show I/O comments

Read I/O comments directly from the PLC. I/O comments do not have to be stored in a Memory Card.

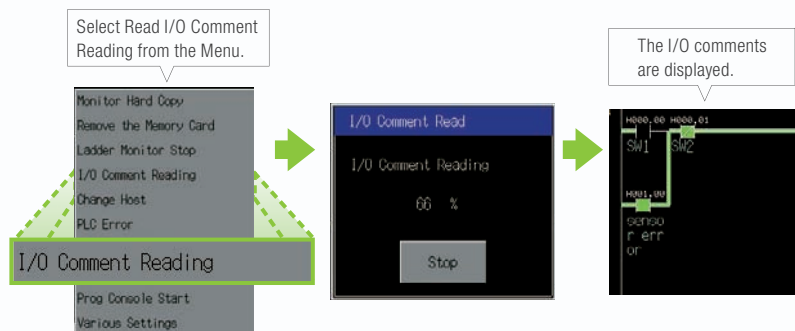

Easy checking the alarm bit and shortens searching time.

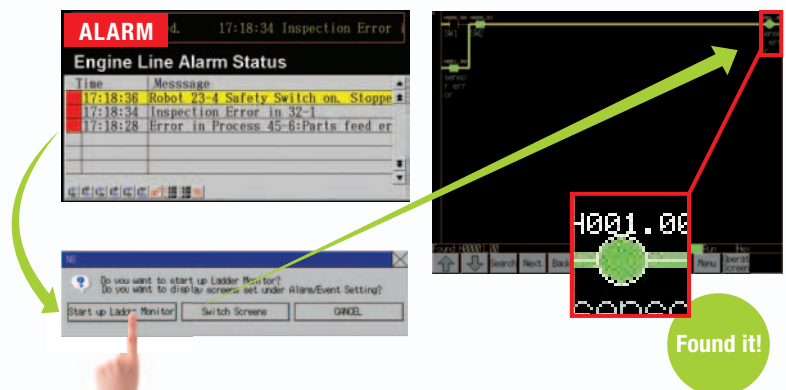

When an alarm occurs, touch the message to automatically search for the alarm bit (output bit) for the alarm. This enables you to quickly check the alarm address and investigate why the bit turned ON.





“Find Back”, “Find Next”, useful Function Supported by the NS-series.

Reduced Time to Investigate Which Output or Input Is Causing the Problem.

Function	Operation with NS-series PT.	CX-Programmer
Find the address at specified by the cursor.	Next	“N” Key
Find the output from the input bit or find the input bit from the output at the cursor.	Double-click 	“Space” Key
Return to the previous search position.	Back 	“B” Key

1. Why is this output not turning ON?
 2. Is this input the cause? What output corresponds to this input?
 3. Why is this output not turning ON?
 4. Which of these two inputs is the cause? Let's look at CIO 21.00 first.
 5. There's no problem with input CIO 21.00. Let's go back to the previous program section.
 6. So is it input CIO 21.01 after all?
 Yes, the problem is here!
 Back

Force-setting and force-resetting are possible

Locations that have been force-set are displayed in pink and can be checked at a glance.

1. Select the input bit for which the output will be forced ON.
 2. Select the address by touching the panel.
 3. Select the Forced Set Option and then press the Update Button.
 4. Forced ON
 Minor changes in values of timers or counters can be made without Support Software.

Check and Change I/O While You View the Ladder Diagram on the I/O Monitor

Display and change the present value by specifying the address. It is also possible to force-set/reset bits with the I/O monitor.

Make the selection with the I/O monitor by touching the screen.
 Changing the present value of the address selected with the Change Value Button

Note: The Ladder Monitor function is not supported by the 5.7-inch models.

NS-Runtime

NS-NSRCL (NS-Runtime)

Achieve machine/line monitoring and data logging on your office computer.

Machine Viewer

Machine monitoring in an office environment. There is no need to create complex host applications. Moreover, when an alarm occurs, a PDF file can be displayed as maintenance information. NS Series screens can be reused on the computer, and screens can be also newly created independently of touch panels at the production site.

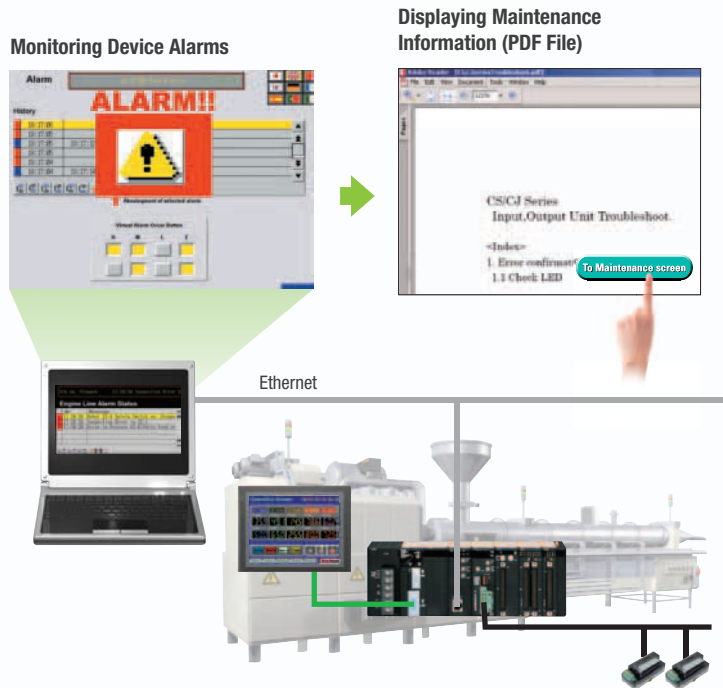

Wide Screen

Computer output can be displayed on another wide-screen monitor. XGA (1,024 x 768 dots) and up to a maximum screen size of 3,840 x 2,400 is supported. Alarms occurring in devices or the line can be monitored.

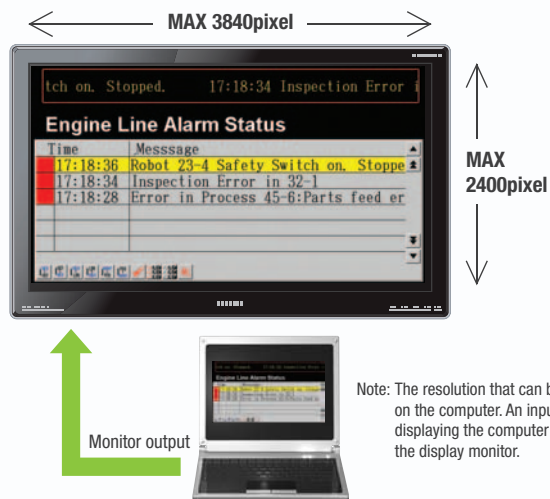

Data Logger

Log large amounts of data using a personal computer. Data can be logged through background processing, with up to 160,000 points stored in one file. The logged data is stored in CSV format, and data can be displayed on data log graphs.



Example: 160,000 Points

Data can be logged for approximately 7.4 days, assuming data is logged every two seconds for 12 hours a day. By using automatic file saving, data logging can be continued even longer than 7.4 days.



Recipe Handling

Checking machine data or switching processes from a host computer is easy. Parameter groups in the PLC can be transferred together to a computer, and the transferred data can be checked and edited in CSV format, e.g., using Excel. The edited data can then be transferred together back to the PLC.

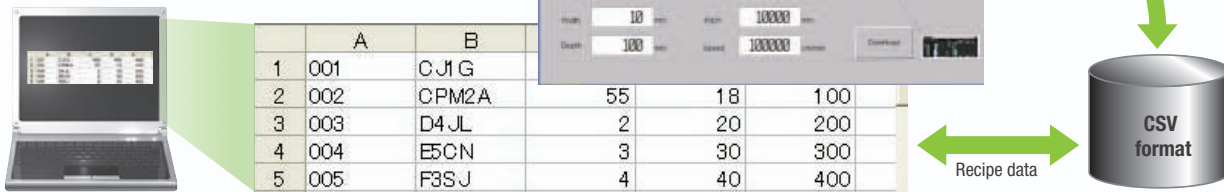

Easy Installation

To get started, just install the NS-Runtime in the computer and place the screen data in the applicable folder. NS/NSJ-series screens and NS-Runtime screens can all be managed using one single tool.

Note: The NS-Runtime will operate in a computer environment even if the CX-Designer installed is not installed. The hardware key (USB dongle) that is supplied with the NS-Runtime is required for operation.

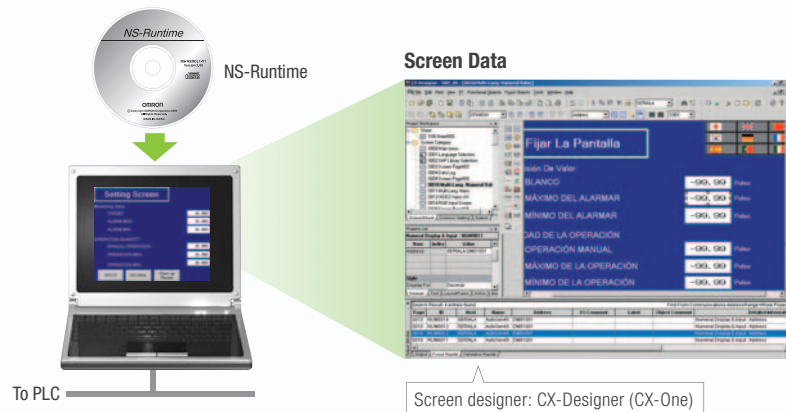

Application Startup Function

User applications can be started from NS-Runtime. Applications can be started simply by pressing buttons on the screen.

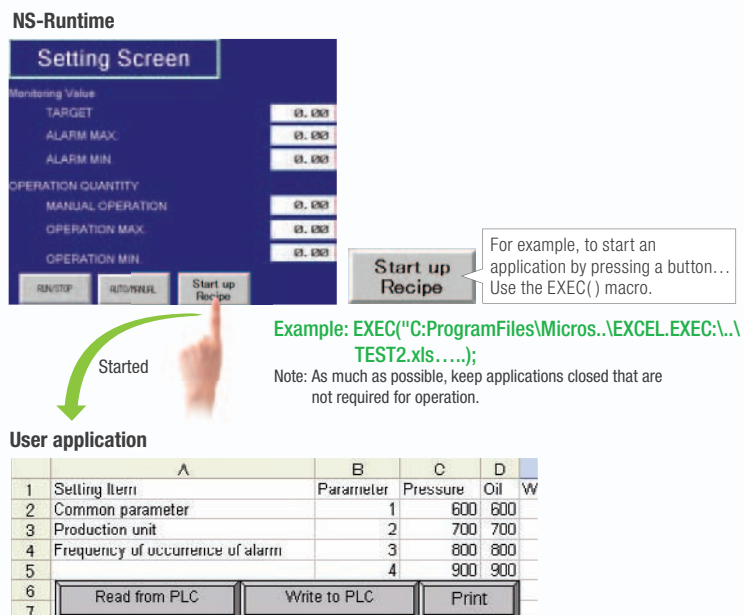

Note 1: If the screen data is converted for the NS Series, NS-Series PT system versions must be 8.1 or earlier. The screen data of system version 8.2 can not be converted for the NS-Runtime.
 Note 2: Do not use this product for 24-hour operation in an FA environment. OMRON shall not be responsible if the computer or application does not operate properly due to noise or other causes. OMRON shall not be responsible for any problems that may be caused by any applications other than OMRON products.

Hand-held PT

NSH5 Series

A hand-held version of the NS5 is now available to perform operations at the production site. The NS-series PT's have a complete set of functions that can be used at the production site, such as the SAP Library, multi-language support, and Programming Console functions.

Function Switches
Use the ten functions switches.
F1, F2, F6, F7: Wired outputs
F3 to F5, F8 to F10: Communications outputs



Memory Card Interface and USB Slave Connector.
Easily transfer screens or save logs at high speed using a USB connection.

Emergency Stop Switch.
3PST-NC Structure
DPST-NC: Increase safety (wired outputs).
SPST-NC: Input to internal NSH5 memory, output to a lamp for emergency stop switch operation, or output via communications, e.g., to a PLC.

Water Resistance to IP65
The water-resistant structure is equivalent to IP65 on all surfaces. The PT may not be suitable for use in environments with long-term water exposure.

PT and Cable Sold Separately
Select the Cable according to the application (RS-232C/RS-422A).
Connector-loose wires, UL connector, 3 m or 10 m.

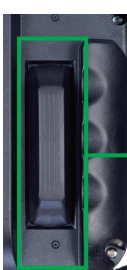
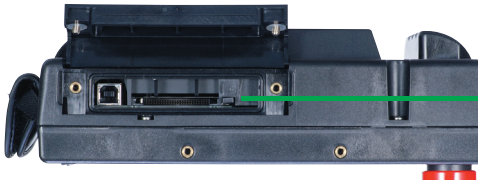
3-Position Enable Switch
Increased safety with DPST-NO structure (wired outputs).

Precautions for Emergency Stop Switches

When using a hand-held NSH5 that will be installed and removed from a control panel or Removable Box, always use the specified Stop Switch (Gray/NSH5-SQG10B-V2) to conform to Safety Standards (EN 60204-1).



Options

Removable Box

A separate external circuit is not required because the Removable Box has been configured so that the emergency stop switch line will not turn OFF (i.e., so that the emergency stop circuit will operate) even when the NSH5 is removed.



Visor

Use when the NSH5 is in direct sunlight.



Mounting Bracket

Use to attach the NSH5 to a control panel.



Programmable Terminals NS Series

Even Simpler Equipment Operation with Outstanding Synergy.



Features

- 5.7 to 12.1 inch sizes are available.
- A hand-held version of the NS5 is now available to perform operations at the production site. The NS-series PT's have a complete set of functions that can be used at the production site.
- The Smart Active Parts(SAP Library) makes it easy to connect to OMRON PLCs and components, OMRON provides a development environment that requires with no programming and no screen designing.
- When an error occurs in a Unit in the OMRON PLCs, the Troubleshooter SAP Library provides an easy-to-understand explanation of the cause of the error as well as the countermeasures.
- Ladder Monitor come as a Standard Feature. The ladder program can be monitored onsite without a laptop! Ladder monitor lets you monitor PLC program status, search for addresses or instructions, monitor multiple I/O points, and much more.
- Provides the FA integrated tool package "CX-One" for a Screen Design Software Integrated Simulation come as a Standard Feature. The integrated simulation function simulates ladder programs and screen data simultaneously even without the actual hardware.
- Screens support 42 languages and the Support Software supports eight. System messages can be displayed in eight languages.
- Single Port Multi Access (SPMA) come as a Standard Feature. The ladder program and screen data can be transferred from a single port!
- Connectable PLCs and devices appear one after another.
Has become connectable with the PLCs of Mitsubishi Electric Corporation and the Inverters of OMRON Corporation.

Sysmac is a trademark or registered trademark of OMRON Corporation in Japan and other countries for OMRON factory automation products. Windows is registered trademarks of Microsoft Corporation in the USA and other countries. EtherCAT® is a registered trademark and patented technology, licensed by Beckhoff Automation GmbH, Germany. Other company names and product names in this document are the trademarks or registered trademarks of their respective companies.

NS Series

Network

Provides serial NT Link communications supporting both 1:1 and 1:N connections. The NT Link has more efficient communications than Host Link and its capabilities are especially apparent in applications with multiple PTs connect to the PLC. The NS-series PTs can also support communications with multiple PLCs and multiple NS-series PTs through Controller Link and Ethernet connections, so the network can be configured freely to match the requirements and scale of the application. In addition, using the NS-Runtime makes it possible to monitor machine status and log data from the host.

[Example NS-series Network Configuration]

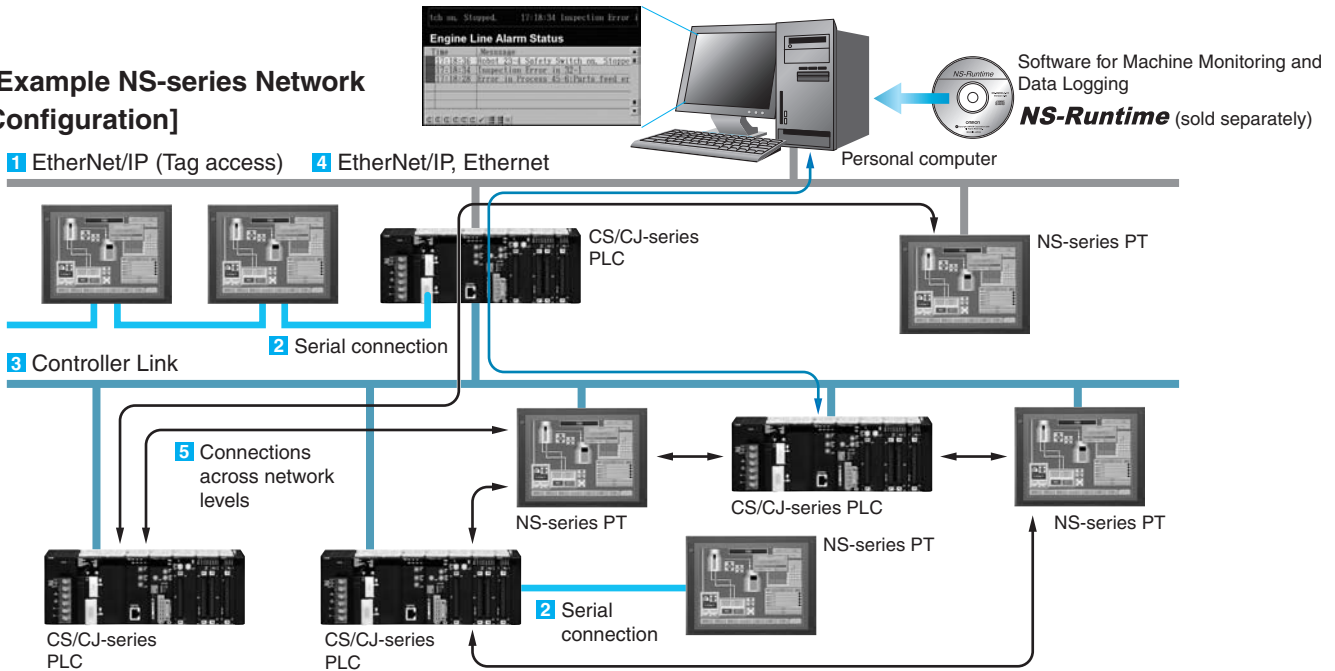

Configuration of CJ2 series, NJ series and NX series

1 EtherNet/IP Connection (Tag accesses)

If an Ethernet-compatible NS-series PT is used, the PT can connect to a Controller with built-in EtherNet/IP and an Option Unit is not needed to connect at the PT.



Configuration of CS series, CJ series and CP series

2 Serial connection

1:1 NT Link or Host Link

●NS:PLC = 1:1

Connecting with the PLC through port A or port B

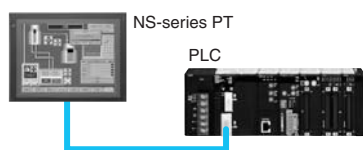

●NS:PLC = 1:2

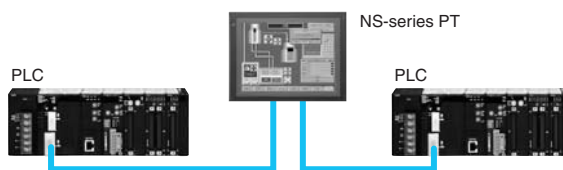

1:N NT Link

●NS:PLC ratio = 8:1 max. Up to 8 NS-series PTs can be connected to each of the PLC's RS-232C/RS-422A ports.

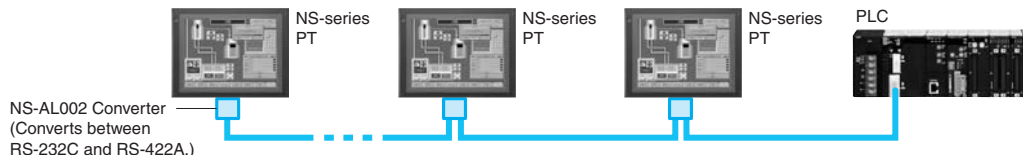

3 Controller Link Connection

The PT can be connected to an OMRON Controller Link network by mounting a Controller Link Interface Unit.

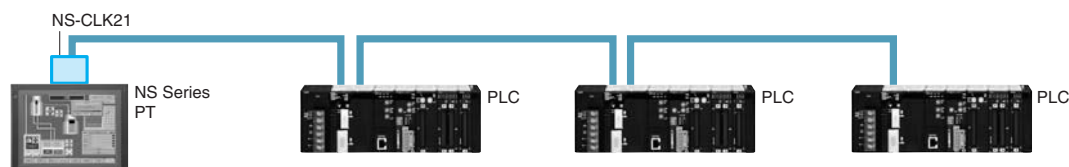

If a Controller Link connection is used, data links can be set between PLCs and multiple PLCs can be monitored/set from the NS-series PT's screen.

- Baud rate
2 Mbps (500 m max.)
1 Mbps (800 m max.)
500 kbps (1 km max.)

●Max. number of nodes: 32 nodes

4 EtherNet/IP or Ethernet Connection

If an Ethernet-compatible NS-series PT is used, the PT can connect to a PLC with an Ethernet Unit and an Option Unit is not needed to connect at the PT.

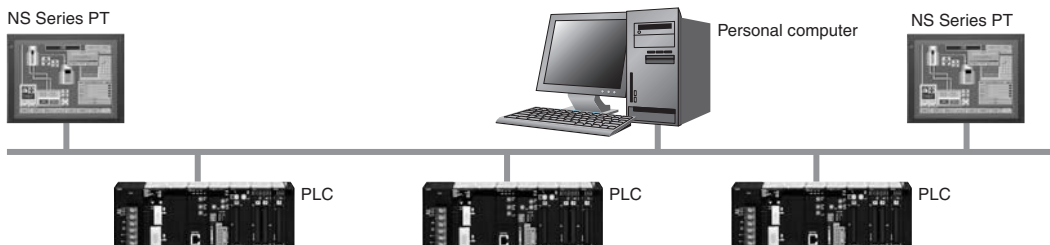

5 Connections Over Network Levels

The NS-series PTs can connect to a variety of devices in the network, through as many as 3 network levels. For example, if SAP (Smart Active Parts) are being used, an NS-series PT connected by Ethernet can be used to monitor the information in a PLC connected through Controller Link as well as the information in the DeviceNet Slaves connected to that PLC.

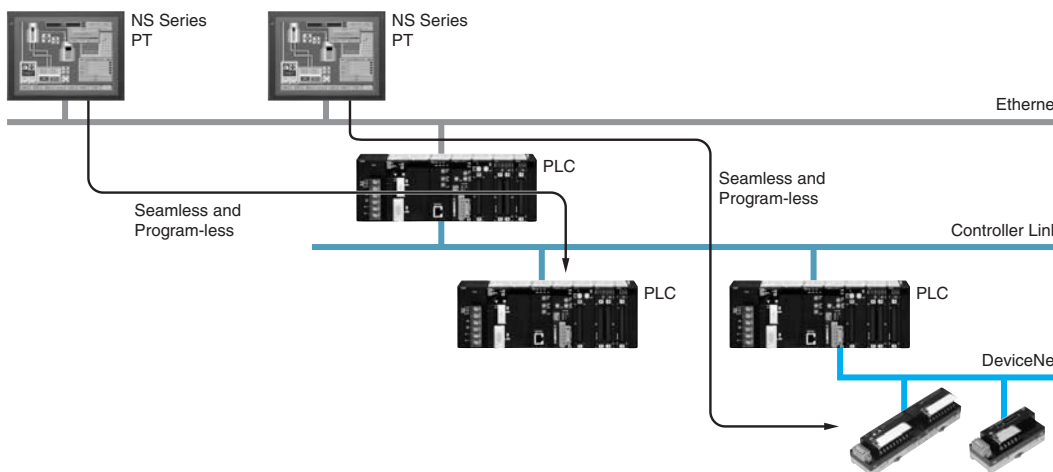

System Configuration

NS5/NS8/NS10/NS12/NS15

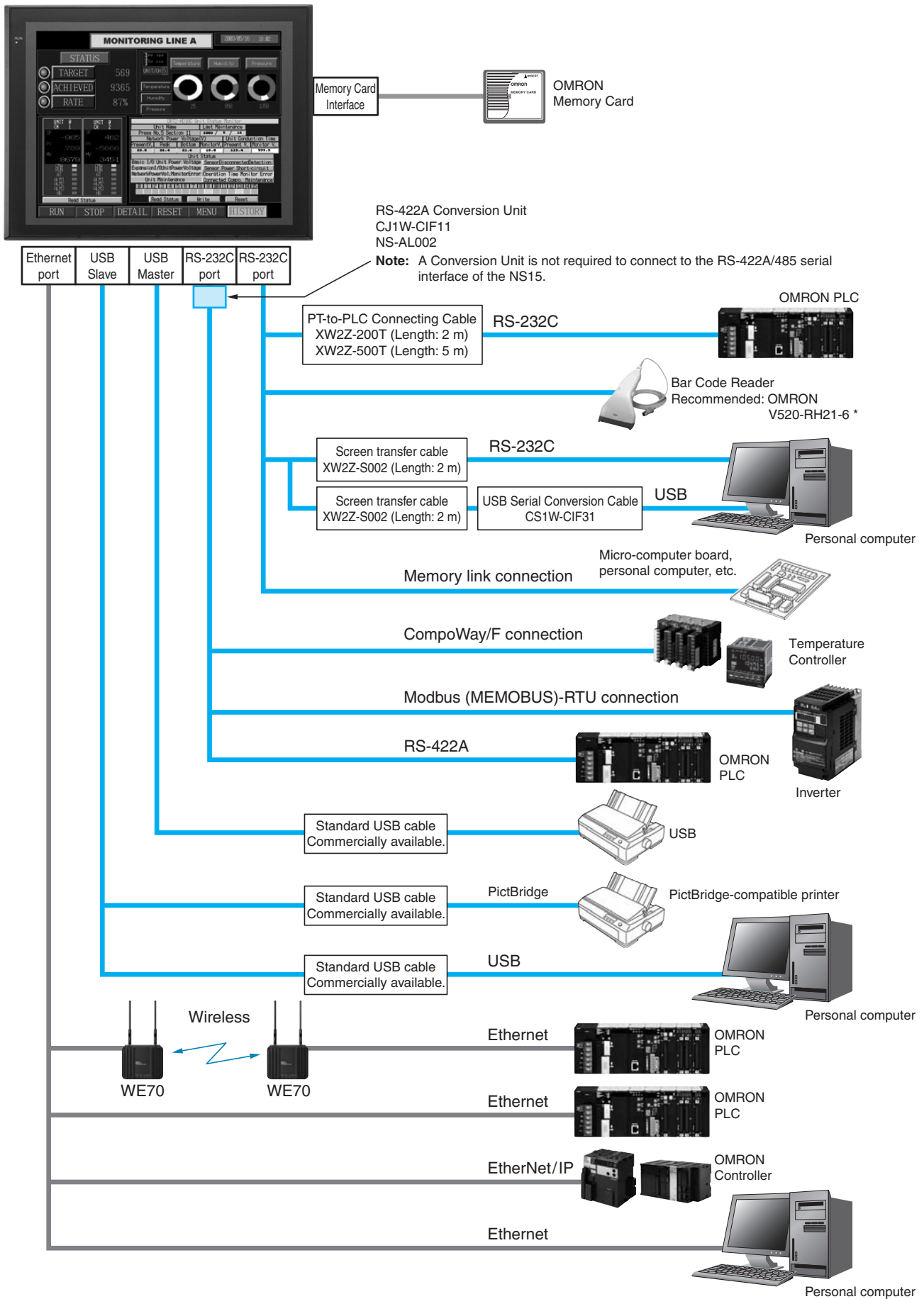

* Bar Code Reader (V520-RH21-6) was discontinued at the end of August 2016.

Expansion Bus Interface

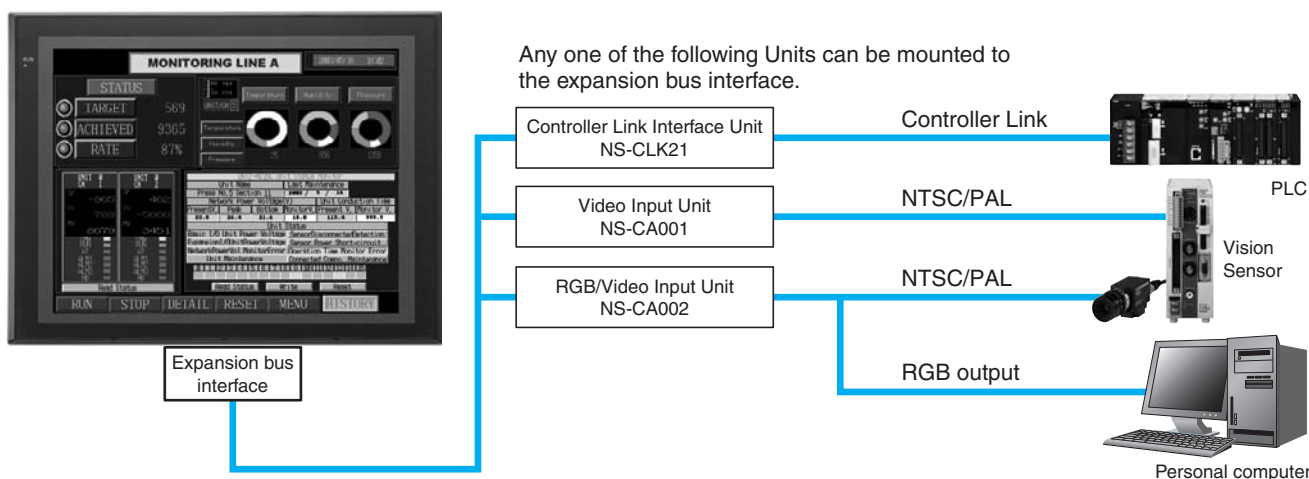

Note: Video Input Units and RGB Video Input Units cannot be used with some models.

Multi-vendor

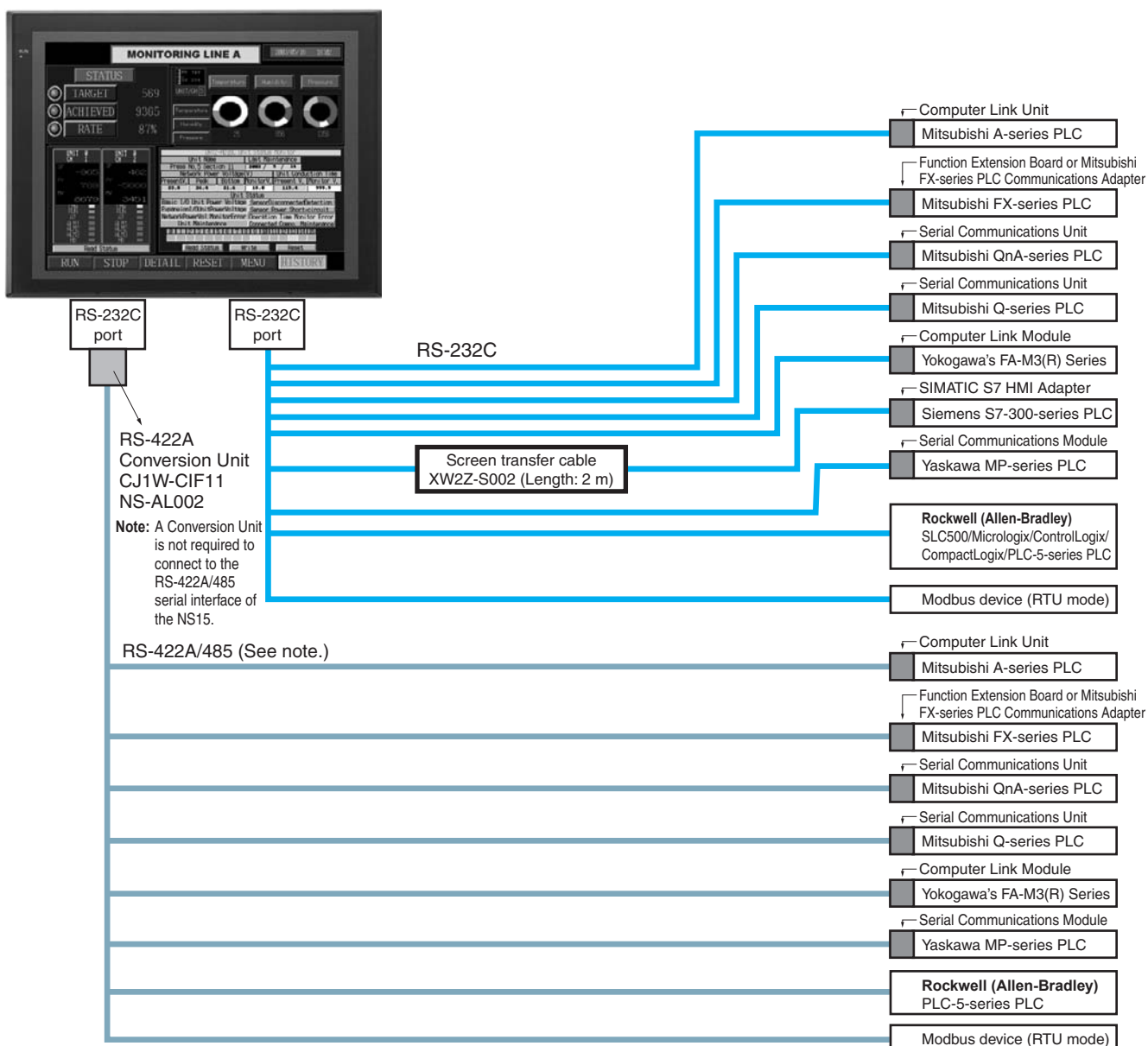

Note: Whether an RS-422A or RS-485 connection is supported depends on the device that you are connecting to. For details, refer to the Connectable Devices page or NS-Series Programmable Terminals HOST CONNECTION MANUAL Multivendor Connection (Cat.V092).

NSH5 Hand-held PT

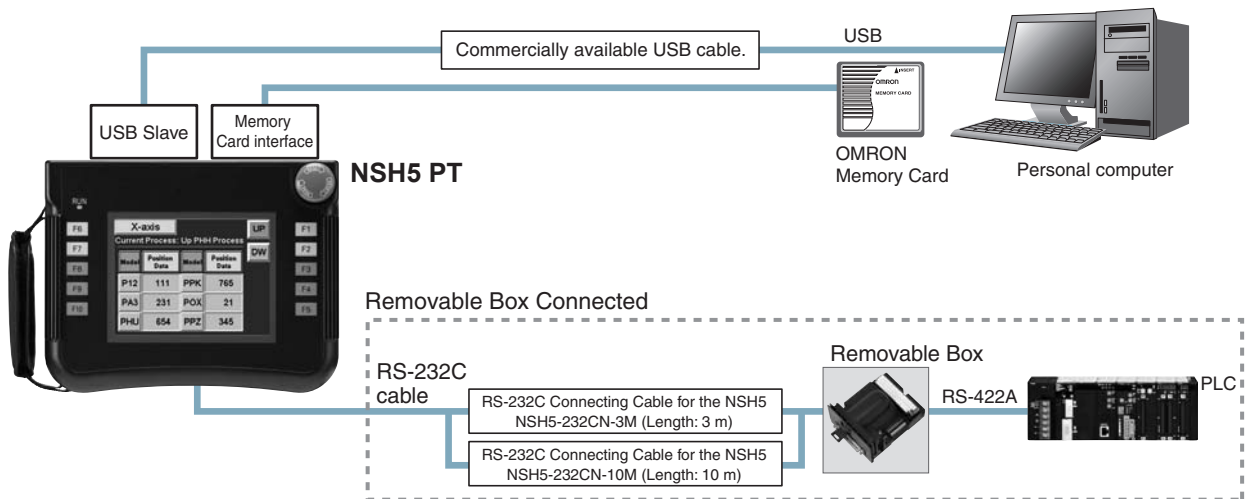
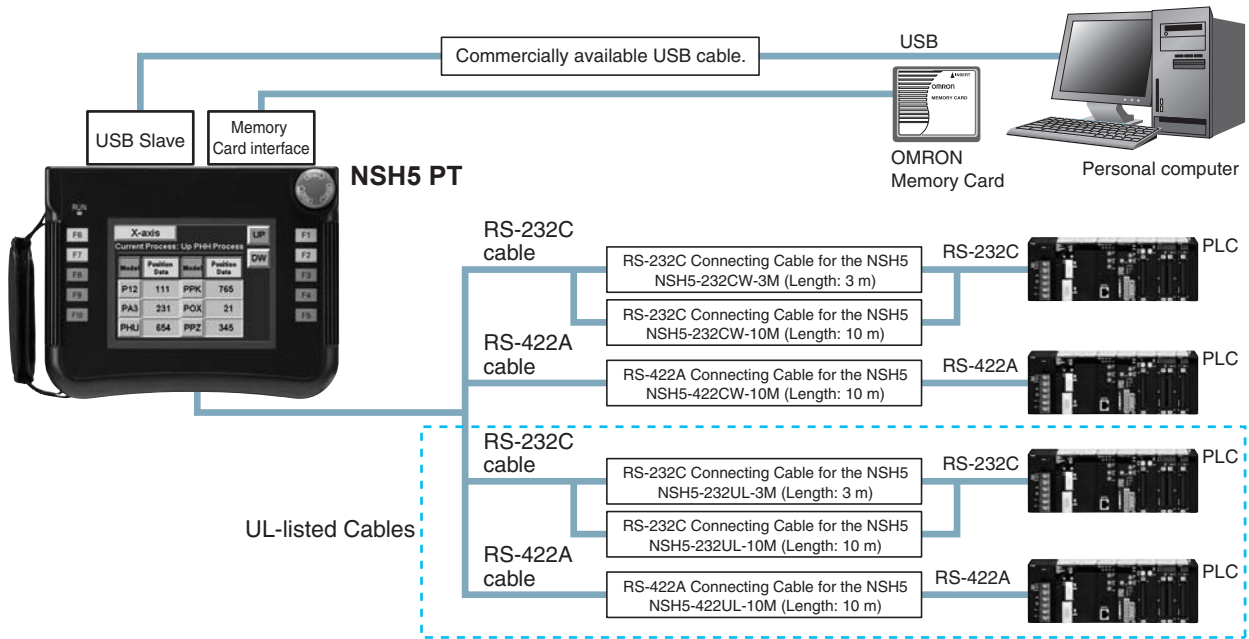

System Configuration (Removable Box Connected)

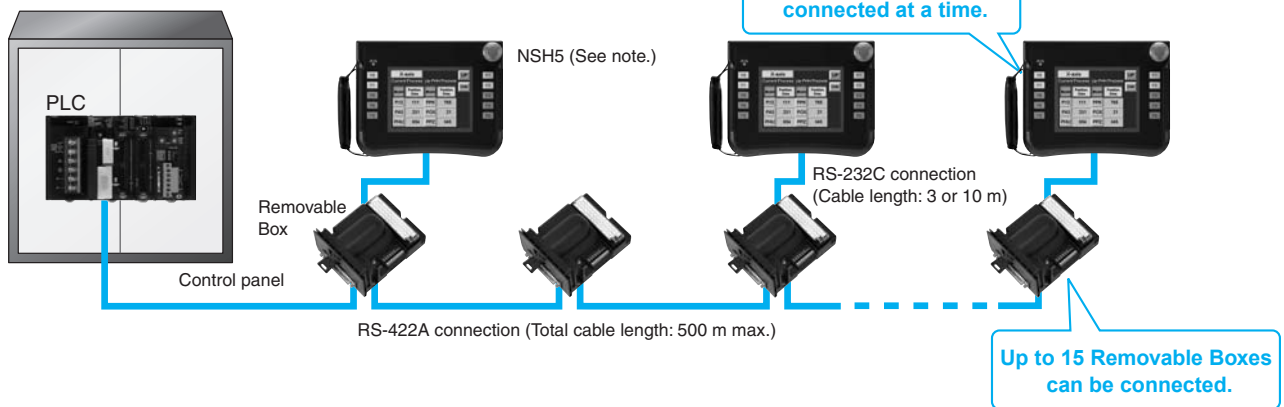

Note: Before removing the NSH5 from the Removable Box, be sure to first turn OFF the power supply key on the Removable Box.

Ordering Information

International Standards

- The standards are available as follows: U: UL, U1: UL (Class I Division 2 Products for Hazardous Locations), C: CSA, UC: cULus, UC1: cULus (Class I Division 2 Products for Hazardous Locations), CU: cUL, N: NK, L: Lloyd, and CE: EC Directives.
- Contact your OMRON representative for further details and applicable conditions for these standards.

Programmable Terminals

Product name	Specifications				Model	Standards
	Effective display area	Number of dots	Ethernet	Case color		
NS5-V2 *1	5.7-inch *2 TFT color LED backlight	320 × 240 dots	No	Ivory	NS5-SQ10-V2	UC1, CE, N, L, UL Type4
				Black	NS5-SQ10B-V2	
			Yes	Ivory	NS5-SQ11-V2	
	Black			NS5-SQ11B-V2		
	5.7-inch *2 High-luminance TFT color LED backlight		No	Ivory	NS5-TQ10-V2	
				Black	NS5-TQ10B-V2	
Yes		Ivory	NS5-TQ11-V2			
	Black	NS5-TQ11B-V2				
NS8-V2	8.4-inch *2 TFT LED backlight	640 × 480 dots	No	Ivory	NS8-TV00-V2	UC1, CE, N, L
				Black	NS8-TV00B-V2	
			Yes	Ivory	NS8-TV01-V2	
				Black	NS8-TV01B-V2	
NS10-V2	10.4-inch *2 TFT LED backlight	640 × 480 dots	No	Ivory	NS10-TV00-V2	UC1, CE, N, L, UL Type4
				Black	NS10-TV00B-V2	
			Yes	Ivory	NS10-TV01-V2	
				Black	NS10-TV01B-V2	
NS12-V2	12.1-inch *2 TFT LED backlight	800 × 600 dots	No	Ivory	NS12-TS00-V2	UC1, CE, N, L, UL Type4
				Black	NS12-TS00B-V2	
			Yes	Ivory	NS12-TS01-V2	
				Black	NS12-TS01B-V2	
NS15-V2	15-inch TFT	1,024 × 768 dots	Yes	Silver	NS15-TX01S-V2	
				Black	NS15-TX01B-V2	
NSH5-V2 *1 Hand-held	5.7-inch TFT	320 × 240 dots	No	Black (Emergency stop button: Red)	NSH5-SQR10B-V2	UC, CE
				Black (Stop button: Gray)	NSH5-SQG10B-V2	

*1. As of July 2008, the image memory has been increased to 60 MB.

*2. Lot No. 15Z0 or later of NS5 color-type models, Lot No. 28X1 or later of NS8 models, Lot No. 11Y1 or later of NS10 models, Lot No. 14Z1 or later of NS12 models, LotNo.31114K or later of NS15 models.

NS-Runtime

Product name	Specifications	Media	Model	Standards	
NS-Runtime	NS-Runtime Installer, PDF manual, hardware key (See note.)	1 license	CD	NS-NSRCL1	—
		3 licenses		NS-NSRCL3	
		10 licenses		NS-NSRCL10	

Note: A hardware key (USB dongle) is required for NS-Runtime operation.

System Requirements

Item	Specifications
OS *	Windows 7 (32-bit/64-bit version)/Windows 8 (32-bit/64-bit version)/Windows 10 (32-bit/64-bit version)
CPU	Celeron, 1.3 GHz or higher (Recommended)
Memory size	HDD: 50 MB min., RAM: 512 MB min. (Windows 7: 1 GB min.). 50 MB is required for the Runtime alone. (An additional 280 MB is required if CX-Server is not already installed.)

* Ver. 1.30 or later of NS Runtime do not support Windows XP (Service Pack 3 or higher) and Windows Vista.

Software

●How to Select Required Support Software for Your Controller

The required Support Software depends on the Controller to connect. Please check the following table when purchasing the Support Software.

Item	Omron PLC System	Omron Machine Automation Controller System
Controller	CS, CJ, CP, and other series	NJ-series and NX-series
Programmable Terminals	NS-series	NS-series with an Ethernet port
Software	FA Integrated Tool Package CX-One	Automation Software Sysmac Studio

●FA Integrated Tool Package CX-One

Product name	Specifications			Model	Standards
		Number of licenses	Media		
FA Integrated Tool Package CX-One Ver.4.□	<p>The CX-One is a comprehensive software package that integrates Support Software for OMRON PLCs and components.</p> <p>CX-One runs on the following OS. Windows XP (Service Pack 3 or higher, 32-bit version) / Windows Vista (32-bit/64-bit version) / Windows 7 (32-bit/64-bit version) / Windows 8 (32-bit/64-bit version) / Windows 8.1 (32-bit/64-bit version) / Windows 10 (32-bit/64-bit version)</p> <p>CX-One Version 4.□ includes CX-Designer Ver.3.□.</p> <p>For details, refer to the CX-One catalog (Cat. No. R134)</p>	1 license *	DVD	CXONE-AL01D-V4	—

* Multi licenses (3, 10, 30, or 50 licenses) and DVD media without licenses are also available for the CX-One.

●Automation Software Sysmac Studio

Please purchase a DVD and required number of licenses the first time you purchase the Sysmac Studio. DVDs and licenses are available individually. Each model of licenses does not include any DVD.

Product name	Specifications			Model	Standards
		Number of licenses	Media		
Sysmac Studio Standard Edition Ver.1.□	<p>The Sysmac Studio provides an integrated development environment to set up, program, debug, and maintain NJ/NX Series CPU Units, NY-series Industrial PC, Controllers and other Machine Automation Controllers, as well as EtherCAT slaves.</p> <p>Sysmac Studio runs on the following OS. Windows 7 (32-bit/64-bit version) / Windows 8 (32-bit/64-bit version) / Windows 8.1 (32-bit/64-bit version) / Windows 10 (32-bit/64-bit version)</p> <p>The Sysmac Studio Standard Edition DVD includes Support Software to set up EtherNet/IP Units, DeviceNet slaves, Serial Communications Units, and Support Software for creating screens on HMI (CX-Designer). Refer to your OMRON website for details.</p>	-(Media only)	DVD	SYSMAC-SE200D	—
		1 license *	—	SYSMAC-SE201L	—

Note: To connect the NJ5 Controller, NS system version 8.5 or higher is required. CX-Designer version 3.3 or higher is also required.
 To connect the NJ1/NJ3 Controller, NS system version 8.61 or higher is required. CX-Designer version 3.4 or higher is also required.
 To connect the NX7 Controller, NS system version 8.9 or higher is required. CX-Designer version 3.64 or higher is also required.
 To connect the NX1 controller, NS system version 8.96 or higher is required. CX-Designer version 3.70 or higher is also required.
 To connect the NX1P controller, NS system version 8.93 or higher is required. CX-Designer version 3.70 or higher is also required.

* Multi licenses are available for the Sysmac Studio (3, 10, 30, or 50 licenses).

Cable







Product name	Specifications		Model	Standards
Cable *1 	Screen transfer cable for DOS/V (CX-Designer ↔ PT)	Length: 2 m	XW2Z-S002	–
	USB-Serial Conversion Cable	Length: 0.5 m	CS1W-CIF31	N
	USB relay cable	Length: 1 m	NS-USBEXT-1M	–
NSH5 Cables	RS-422A cable (loose wires + D-Sub 9-pin)	Length: 10 m	NSH5-422CW-10M	–
	RS-232C cable (loose wires + D-Sub 9-pin)	Length: 3 m	NSH5-232CW-3M	–
	RS-232C cable (loose wires + D-Sub 9-pin)	Length: 10 m	NSH5-232CW-10M	–
UL-compliant NSH5 Cable	RS-422A cable (loose wires)	Length: 10 m	NSH5-422UL-10M	CU
	RS-232C cable (loose wires + relay cable)	Length: 3 m	NSH5-232UL-3M	
	RS-232C cable (loose wires + relay cable)	Length: 10 m	NSH5-232UL-10M	
PT-to-PLC Connecting Cable *2	PT connection: 9 pins PLC connection: 9 pins	Length: 2 m	XW2Z-200T	–
		Length: 5 m	XW2Z-500T	
	PT connection: 9 pins PLC peripheral port	Length: 2 m	XW2Z-200T-2	
		Length: 5 m	XW2Z-500T-2	
NSH5 Removable Box Cable	RS-232C Cable (connectors)	Length: 3 m	NSH5-232CN-3M	
		Length: 10 m	NSH5-232CN-10M	
NSH5 Removable Box	–		NSH5-AL001	
NSH5 Wall-mounting Bracket	–		NSH5-ATT02	
NSH5 Visor	–		NSH5-ATT01	

*1. Use a standard USB Type A male to Type B type male Cable to connect the NS series PT to a personal computer (CX-Designer). We recommend that you use a USB cable with a ferrite core attached to ensure stable communications. (Examples: FH-VUAB from OMRON and U2C-BF series (US2-BF□□BK) from ELECOM as of February 2016)

Use a standard USB cable to connect the NS series PT to a PictBridge-compatible printer. USB cable type depends on the printer.

*2. To connect the NS series PT to NJ series Controller, using a commercially available 10/100-BASE-TX twisted-pair cable. For detail, refer to the NS series SETUP MANUAL (Cat. No.V083).

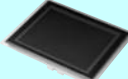
Options

Product name	Specifications	Model	Standards	
Video Input Unit  	Inputs: 4 channels Signal type: NTSC/PAL	NS-CA001	UC1, CE	
	Input channels: 2 video channels and 1 RGB channel *1 Signal type: NTSC/PAL	NS-CA002		
Controller Link Interface Unit 	For Controller Link Communications	NS-CLK21	UC1, CE	
RS-422A Adapter  	Transmission distance: 500 m total length Note: Use this model when connecting PT models without a V□ suffix. Note: PT models with the V□ suffix can also be connected.	NS-AL002	—	
	Transmission distance: 50 m total length Note: Only PT models with a suffix of V□ are connectable. Use the NS-AL002 to connect models without a V□ suffix.	CJ1W-CIF11	UC1, N, L, CE	
Sheet/Cover *2 	Anti-reflection Sheets (5 surface sheets)	NS15	NS15-KBA04	—
		NS12/10	NS12-KBA04	
		NS8	NS7-KBA04	
		NS5	NT30-KBA04	
	Protective Covers (5 pack) (anti-reflection coating)	NS12/10	NS12-KBA05	
		NS8	NS7-KBA05	
		NS5	NT31C-KBA05	
	Protective Covers (1 cover included) (Transparent)	NS15	NS15-KBA05N	
Protective Covers (5 covers included) (Transparent)	NS12/10	NS12-KBA05N		
	NS8	NS7-KBA05N		
	NS5	NT31C-KBA05N		
Attachment	NT625C/631/631C Series to NS12/10 Series	NS12-ATT01	—	
	NT625C/631/631C Series to NS12/NS10 Series (Black)	NS12-ATT01B		
	NT610C Series to NS12/10 Series	NS12-ATT02		
	NT620S/620C/600S Series to NS8 Series	NS8-ATT01		
	NT600M/600G/610G/612G Series to NS8 Series	NS8-ATT02		
Memory Card 	128 MB	HMC-EF183	—	
	256 MB	HMC-EF283		
	512 MB	HMC-EF583		
Memory Card Adapter	---	HMC-AP001	CE	
Replacement Battery	Battery life: 5 years (at 25°C)	CJ1W-BAT01	—	
Bar Code Reader *3	CCD handheld bar code reader (RS-232C interface)	V520-RH21-6	—	

*1. One screen cannot display two video inputs simultaneously.

*2. A Chemical-resistant Cover (NT30-KBA01) is available only for the NS5.

*3. Bar Code Reader (V520-RH21-6) was discontinued at the end of August 2016.

General Specifications

NS5/NS8/NS10/NS12/NS15

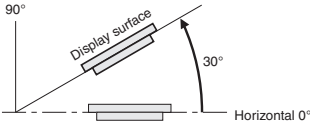
Series	NS5-V2	NS8-V2	NS10-V2	NS12-V2	NS15-V2
Rated power supply voltage	24 VDC				
Allowable voltage range	20.4 to 27.6 VDC (24 VDC \pm 15%)				
Power consumption	15 W max.	25 W max.			45 W max.
Ambient operating temperature	0 to 50 °C (See note on the next page.) Note: The ambient operating temperature is subject to the following restrictions according to the mounting angle. Mounting angle of 0 to 30° to the horizontal: • When no Expansion Units are mounted, the operating temperature range is 0 to 45°C. • When a Video Input Unit or a Controller Link Interface Unit is mounted, the ambient operating temperature is 0 to 35°C. Mounting angle of 30 to 90° to the horizontal: Operating temperature range of 0 to 50°C				
Storage temperature	-20 to 60 °C *1				
Ambient operating humidity	35 to 85% (0 to 40 °C), 35 to 60% (40 to 50 °C) (with no condensation)				
Operating environment	No corrosive gases.				
Noise immunity	Conforms to IEC61000-4-4, 2 kV (power lines).				
Vibration resistance (during operation)	10 to 57 Hz, 0.075 mm amplitude, 57 to 150 Hz, 9.8 m/s ² 30 min each in X, Y, and Z directions				5 to 8.4 Hz, 3.5 mm single amplitude, 8.4 to 150 Hz, 9.8 m/s ² 10 min times each in X, Y, and Z directions
Shock resistance (during operation)	147 m/s ² 3 times each in direction of X, Y, and Z				
Weight	1.0 kg max.	2.0 kg max.	2.3 kg max.	2.5 kg max.	4.2 kg max.
Degree of protection	Front operating panel: IP65 oil-proof type and NEMA4 UL type 4. *2 Note: May not be applicable in locations with long-term exposure to oil.				
Ground	Ground to 100 Ω or less.				
Battery life	5 years (at 25 °C): Replace battery within 5 days after the battery runs low (indicator lights orange).				
Applicable standards	Certified for conformance to UL 508, UL 1604, EMC Directive, NK, and LR Standards.				

*1. Operate the PT within the temperature and humidity ranges shown in the right diagram.

*2. Support for NS5, NS10, NS12 and NS15.

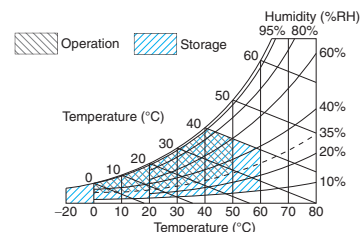

NSH5 Hand-held PT

Series	NSH5-V2	
Type	5.7-inch Color TFT (Hand-held Version)	
Case color	Black	
Built-in Ethernet port	No	
Model	NSH5-SQR10B-V2 (Emergency stop button: Red)	NSH5-SQG10B-V2 (Stop button: Gray)
Rated power supply voltage	24 VDC	
Allowable voltage range	20.4 to 27.6 VDC (24 VDC \pm 15%)	
Power consumption	10 W max.	
Ambient operating temperature	0 to 40°C	
Storage temperature	-20 to 60°C	
Ambient operating humidity	35% to 85% (0 to 40°C) with no condensation	
Operating environment	No corrosive gases.	
Noise immunity	Common mode: 1,000 Vp-p (between power supply terminals and panel) Normal mode: 300 Vp-p Pulse width: 100 ns to 1 μ s, Rise time: 1-ns pulse	
Vibration resistance (during operation)	10 to 57 Hz, 0.075 mm amplitude, 57 to 150 Hz, 9.8 m/s ² 30 min each in X, Y, and Z directions	
Shock resistance (during operation)	147 m/s ² 3 times each in direction of X, Y, and Z	
Weight	1 kg max.	
Degree of protection	Equivalent to IP65.	
Ground	Ground to 100 Ω or less.	
Battery life	5 years (at 25°C): Replace battery within 5 days after the battery runs low (indicator lights orange).	
Applicable standards	Certified for conformance to UL 508, EMC Directive, and EN 60204-1.	

Performance/Specifications

NS5

Series	NS5-V2							
Model	NS5-SQ10-V2	NS5-SQ11-V2	NS5-SQ10B-V2	NS5-SQ11B-V2	NS5-TQ10-V2	NS5-TQ11-V2	NS5-TQ10B-V2	NS5-TQ11B-V2
Built-in Ethernet port	No	Yes	No	Yes	No	Yes	No	Yes
Case color	Ivory		Black		Ivory		Black	
Display device	TFT color LCD				Color High-luminance TFT *1			
Effective display area	Width 117.2 × height 88.4 mm (5.7 inches)							
Display colors	256 colors							
Number of dots	320 dot horizontal × 240 dot vertical							
View angle	Left/right: 80°, Top: 80°, Bottom: 60° *5							
Screen data capacity	60 Mbytes							
Image data (BMP or JPG images)	32,768 colors							
Memory Card	Supported							
Ladder Monitor function	Not supported							
Video Input Unit support	Not supported							
Controller Link Interface Unit (Wired) support	Not supported							
Backlight *2	Service life *3	75,000 hours min.						
	Brightness adjustment	Three-level or 32-level brightness adjustment from the touch panel screen. *4						
	Backlight error detection *5	Error is detected automatically, and the RUN indicator flashes green as notification.						
Touch panel (matrix type)	Method	Matrix resistive membrane type						
	Number of switches/resolution	300 (20 horizontal × 15 vertical) 16 × 16 dots for each switch						
	Input	Pressure-sensitive						
	Service life	1,000,000 touch operations.						
Display text	Labels	Can be specified in CX-Designer. Font, style, and size can be specified.						
	Numerals, alarms, and character strings	Scalable Gothic: Magnification: 6 to 255 points Rough: Magnification: 1×1, 1×2, 2×1, 2×2, 3×3, 4×4, 8×8 Standard: Magnification: 1×1, 1×2, 2×1, 2×2, 3×3, 4×4, 8×8 Fine: Magnification: 1×1, 1×2, 2×1, 2×2, 3×3, 4×4, 8×8 7-segment display: Can display only numerals, dates, and times.						
	Supported languages (42 languages)	Scalable Gothic, rough, standard, and fine can be used for 42 languages. Japanese, simplified Chinese, traditional Chinese, Korean, English, French, German, Italian, Portuguese, Spain, Swedish, Dutch, Finnish, Norwegian, Basque, Catalan, Danish, Albanian, Croatian, Czech, Hungarian, Polish, Romanian, Slovak, Slovenian, Bulgarian, Belarusian, Russian, Serbian, Macedonian, Ukrainian, Georgian, Icelandic, Afrikaans, Faroese, Indonesian, Greek, Turkish, Estonian, Latvian, Lithuanian, Thai (supported only with scalable Gothic font)						
Text attributes	Color	256 colors						
	Font style (only when vector font is specified)	Bold or italic						
	Vertical alignment	Top, center, or bottom						
	Horizontal alignment	Left-justified, centered, or right-justified						
Flicker	Objects supporting flicker	Functional objects: Select from up to 10 types of registered flicker settings. The flicker speed and flicker range can be set. Fixed objects: Select from three flicker types.						
Numeral units and scale settings	1.000 max.							
Alarm/event settings	5,000 max.							
Expansion interface	For Expansion Interface Units (Beginning with units produced in Feb. 2018, connectors are not mounted)							

*1. NS5-TQ series (high luminance TFT) luminance is better than that of NS5-SQ series by about 110 cd/m².

*2. Contact your nearest OMRON representative to replace the backlight.

*3. This is the estimated time before brightness is reduced by half at room temperature and humidity. It is not a guaranteed value.

The service life will be dramatically shortened if PT is used at low temperatures. For example, using the PT at temperatures of 0°C will reduce the service life to approximately 10,000 hours (reference value).

*4. Lot No. 15Z0 or later of NS5 models.

*5. This function does not indicate that the service life has been reached. It detects when the backlight is not lit due to a disconnection or other errors.

Backlight error detection indicates that all backlights (2) are OFF.

NS8/NS10/NS12/NS15

Series	NS8-V2				NS10-V2				NS12-V2				NS15-V2	
Model	NS8-TV00-V2	NS8-TV01-V2	NS8-TV00B-V2	NS8-TV01B-V2	NS10-TV00-V2	NS10-TV01-V2	NS10-TV00B-V2	NS10-TV01B-V2	NS12-TS00-V2	NS12-TS01-V2	NS12-TS00B-V2	NS12-TS01B-V2	NS15-TX01S-V2	NS15-TX01B-V2
Built-in Ethernet port	No	Yes	No	Yes	No	Yes	No	Yes	No	Yes	No	Yes	Yes	Yes
Case color	Ivory		Black		Ivory		Black		Ivory		Black		Silver	Black
Display device	High-definition TFT color LCD				High-definition TFT color LCD				High-definition TFT color LCD				High-definition TFT color LCD	
Effective display area	Width 170.9 × height 128.2 mm (8.4 inches)				Width 215.2 × height 162.4 mm (10.4 inches)				Width 246.0 × height 184.5 mm (12.1 inches)				Width 304.1 × height 228.1 mm (15 inches)	
Display colors	256 colors													
Number of dots	640 dot horizontal × 480 dot vertical								800 dot horizontal × 600 dot vertical				1,024 dot horizontal × 768 dot vertical	
View angle	Left/right: 80°, Top: 80°, Bottom: 60° *3				Left/right: 70°, Top: 65°, Bottom: 65° *3				Left/right: 80°, Top: 80°, Bottom: 80° *3				Left/right: 80°, Top: 70°, Bottom: 60°	
Screen data capacity	60 Mbytes													
Image data (BMP or JPG images)	32,768 colors													
Memory Card	Supported													
Ladder Monitor function	Supported													
Video Input Unit support	Supported (Image displayed via video input is 260,000 colors)												(Only RGB input is enabled.)	
Controller Link Interface Unit (Wired) support	Not supported				Supported									
Backlight *1	Service life *2	50,000 hours min.												
	Brightness adjustment	Three-level or 32-level brightness adjustment from the touch panel screen. *3												
	Backlight error detection *4	Error is detected automatically, and the RUN indicator flashes green as notification.												
Touch panel (matrix type)	Method	Matrix resistive membrane type											Analog resistive membrane type *5	
	Number of switches/resolution	768 (32 horizontal × 24 vertical) 20 × 20 dots for each switch			1,200 (40 horizontal × 30 vertical) 16 × 16 dots for each switch				1,900 (50 horizontal × 38 vertical) 16 × 16 dots for each switch				Resolution: 1,024 (horizontal) × 1,024 (vertical)	
	Input	Pressure-sensitive												
	Service life	1,000,000 touch operations.												
Display text	Labels	Can be specified in CX-Designer. Font, style, and size can be specified.												
	Numerals, alarms, and character strings	Scalable Gothic: Magnification: 6 to 255 points Rough: Magnification: 1×1, 1×2, 2×1, 2×2, 3×3, 4×4, 8×8 Standard: Magnification: 1×1, 1×2, 2×1, 2×2, 3×3, 4×4, 8×8 Fine: Magnification: 1×1, 1×2, 2×1, 2×2, 3×3, 4×4, 8×8 7-segment display: Can display only numerals, dates, and times.												
	Supported languages (42 languages)	Scalable Gothic, rough, standard, and fine can be used for 42 languages. Japanese, simplified Chinese, traditional Chinese, Korean, English, French, German, Italian, Portuguese, Spain, Swedish, Dutch, Finnish, Norwegian, Basque, Catalan, Danish, Albanian, Croatian, Czech, Hungarian, Polish, Romanian, Slovak, Slovenian, Bulgarian, Belarusian, Russian, Serbian, Macedonian, Ukrainian, Georgian, Icelandic, Afrikaans, Faroese, Indonesian, Greek, Turkish, Estonian, Latvian, Lithuanian, Thai (supported only with scalable Gothic font)												
Text attributes	Color	256 colors												
	Font style (only when vector font is specified)	Bold or italic												
	Vertical alignment	Top, center, or bottom												
	Horizontal alignment	Left-justified, centered, or right-justified												
Flicker	Objects supporting flicker	Functional objects: Select from up to 10 types of registered flicker settings. The flicker speed and flicker range can be set. Fixed objects: Select from three flicker types.												
Numeral units and scale settings	1,000 max.													
Alarm/event settings	5,000 max.													
Expansion interface	For Expansion Interface Units													

*1. Contact your nearest OMRON representative to replace the backlight.

*2. This is the estimated time before brightness is reduced by half at room temperature and humidity. It is not a guaranteed value.

The service life will be dramatically shortened if PT is used at low temperatures. For example, using the PT at temperatures of 0 °C will reduce the service life to approximately 10,000 hours (reference value).

*3. Lot No. 28X1 or later of NS8 models, Lot No. 11Y1 or later of NS10 models, Lot No. 14Z1 or later of NS12 models, Lot No. 31114K or later of NS15 models.

*4. This function does not indicate that the service life has been reached. It detects when the backlight is not lit due to a disconnection or other errors. Backlight error detection indicates that all backlights (2) are OFF.

*5. An analog touch panel is used with the NS15. Do not press the touch panel in two or more places simultaneously.

If the touch panel is pressed in two or more places simultaneously, it may activate a switch between the points that are pressed.

Communications

NS5/NS8/NS10/NS12/NS15

Memory Card		Interface	One ATA-Compact Flash interface slot
		Functions	Used to transfer and store screen data, store logging data, and store history data. (Alarm/Event History, Operation Log, and Error Log generated during Macro execution).
Serial Communications	Port A	Connector	Conforms to EIA RS-232C. D-Sub female 9-pin connector 5-V output (250 mA max.) through pin 6. The 5-V outputs of serial ports A and B cannot be used at the same time.
		Functions	Host (PLC) access: 1:N NT Links (connections with CS/CJ/CP-series PLCs and C200HX/HG/HE(-Z) PLCs), 1:1 NT Links, or Host Link (connections with C Series or CVM1/CV-series PLCs) Direct access to Temperature Controllers using Smart Active Parts: CompoWay / F and bar code reader connections (Read directly from display.)
	Port B	Connector	Conforms to EIA RS-232C. D-Sub female 9-pin connector. 5-V output (250 mA max.) through pin 6. The 5-V outputs of serial ports A and B cannot be used at the same time.
		Functions	Host (PLC) access: 1:N NT Links (connections with CS/CJ/CP-series PLCs and C200HX/HG/HE(-Z) PLCs) or 1:1 NT Links (connections with C Series or CVM1/CV-series PLCs) Direct access to Temperature Controllers using Smart Active Parts: CompoWay / F and bar code reader connections (Read directly from display.)
USB SLAVE Specifications		USB rating	USB1.1
		Connector	TYPE-B (Slave)
		Functions	Connection with the CX-Designer (for screen data transfers) Connecting to a PictBridge-compatible Printer Recommended printers: EPSON: PM-G4500, PX-G5300, PX-5600, EP-901F Canon: PIXUS MX7600, PIXUS iP100, PIXUS iX5000
USB HOST Specifications *1		USB rating	USB1.1
		Connector	TYPE-A (Host)
		Functions	Connection with a printer (for hard copies) Recommended printers: EPSON: PX-G930
Built-in Ethernet Specifications *2		Conformance standards	Conforms to IEEE 802.3/Ethernet (10 Base-T/100 Base-TX).
		Functions	Host (PLC) access and connection with the CX-Designer (for screen data transfers)
Controller Link (Wired-type) Specifications *3		Baud rate	2 M/1 M/500 K bps
		Transmission path	Shielded twisted-pair cable (special cable)
		Functions	Host (PLC) access and data links
Video Input Specifications *4		Resolution	NS-CA001: 320×240, 640×480, 800×600 dots NS-CA002: User-defined size
		Input signal	NS-CA001: NTSC composite video or PAL NS-CA002: NTSC composite video or PAL
		Number of video inputs	NS-CA001: Number of cameras: 4 max. NS-CA002: 2 cameras + RGB

*1. Except NS5.

*2. NS□-□□□1-V2 only.

*3. Except NS5 and NS8.

*4. Except NS5 and NS15. NS15 provides RGB input. (NS-CA002)

Connectable Devices

Supported OMRON PLCs

PLC series	PLC model name	RS-232C *1			Ethernet		Controller Link *4
		1:1 NT Link	1:N NT Link	Host Link	FINS *2	EtherNet/IP *3	
C Series	CQM1	Yes	No	Yes	No	No	No
	CQM1H	Yes	Yes	Yes	No	No	Yes
	CPM1	Yes	No	Yes	No	No	No
	CPM1A	Yes	No	No	No	No	No
	CPM2A	Yes	No	Yes	No	No	No
	CPM2C	Yes	No	Yes	No	No	No
	C200HS	Yes	No	Yes	No	No	No
	C200HE (-Z)	Yes	Yes	Yes	No	No	Yes
	C200HG (Z)	Yes	Yes	Yes	No	No	Yes
C200HX (-Z)	Yes	Yes	Yes	No	No	Yes	
CVM1/CV Series	CV500/1000/2000	Yes	No	Yes	Yes	No	Yes
	CVM1	Yes	No	Yes	Yes	No	Yes
CS Series	CS1H	No	Yes	Yes	Yes	Yes	Yes
	CS1G	No	Yes	Yes	Yes	Yes	Yes
	CS1D	No	Yes	Yes	Yes	Yes	Yes
CJ Series	CJ1H	No	Yes	Yes	Yes	Yes	Yes
	CJ1G	No	Yes	Yes	Yes	Yes	Yes
	CJ1M	No	Yes	Yes	Yes	Yes	Yes
	CJ2H	No	Yes	Yes	Yes	Yes *5	Yes
	CJ2M	No	Yes	Yes	Yes	Yes *5	Yes
CP Series	CP1H	No	Yes	Yes	Yes	Yes	No
	CP1L	No	Yes	Yes	Yes	No	No
	CP1E	No	Yes	Yes	No	No	No
NJ Series	NJ5/NJ3/NJ1	Yes *6	Yes *6	Yes *6	No	Yes *7	No
NX Series	NX7/NX1/NX1P	No	No	No	No	Yes *8	No

Note: Including models whose production were discontinued.

*1. To connect a NS with a PLC via a RS-422A connection, OMRON's NS-AL002, or CJ1W-CIF11 RS-232C/RS-422A Converter can be used to convert the RS-232C port on the NS to RS-422A.

*2. A NS with Ethernet port is necessary.

When connecting a PLC with the NS, an Ethernet port is necessary on the PLC, too. Use a PLC CPU Unit with a built-in Ethernet port, or add an Ethernet Unit.

*3. A NS with Ethernet port is necessary.

When connecting a PLC with the NS, an EtherNet/IP port is necessary on the PLC, too. Use a PLC CPU Unit with a built-in EtherNet/IP port, or add an EtherNet/IP Unit.

*4. Install a Controller Link Interface Unit on the NS. A Controller Link Unit is necessary for the PLC.

*5. For CJ2, CX-Designer version 3.2 or later, and NS system version 8.4 or later are required.

*6. Mount a Serial Communications Unit on the NJ-series Controller. A NS can access only to the Controller's memory used for CJ-series unit.

*7. When using a EtherNet/IP Unit to connect the NJ-series Controller, NJ Troubleshooter is not supported.

For NJ5, CX-Designer version 3.3 or later, and NS system version 8.5 or later are required.

For NJ3, CX-Designer version 3.4 or later, and NS system version 8.61 or later are required.

Moreover, the multidimensional array is supported in the combination with NJ.

*8. For NX7, CX-Designer version 3.64 or later, and NS system version 8.9 or later are required.

For NX1P, CX-Designer version 3.70 or later, and NS system version 8.93 or later are required.

For NX1, CX-Designer version 3.70 or later, and NS system version 8.96 or later are required.

Moreover, the multidimensional array is supported in the combination with NX.

Function Comparison

PLC series	PLC model name	Ladder Monitor	Device Monitor/ Switch Box	PLC Data Trace	SPMA	SAP	EtherNet/IP Tag access (Network symbols)	PLC Troubleshooter	NJ Troubleshooter/ Integrated NS-series PT simulation *4
C series	CQM1	No	No	No	No	No	No	No	No
	CQM1H	No	No	No	No	No	No	No	No
	CPM1	No	No	No	No	No	No	No	No
	CPM1A	No	No	No	No	No	No	No	No
	CPM2A	No	No	No	No	No	No	No	No
	CPM2C	No	No	No	No	No	No	No	No
	C200HS	No	No	No	No	No	No	No	No
	C200HE (-Z)	No	No	No	No	No	No	No	No
	C200HG (-Z)	No	No	No	No	No	No	No	No
C200HX (-Z)	No	No	No	No	No	No	No	No	
CVM1/CV series	CV500/1000/2000	No	No	No	No	No	No	No	No
	CVM1	No	No	No	No	No	No	No	No
CS series	CS1H	Yes	Yes	Yes	Yes	Yes	No	Yes	No
	CS1G	Yes	Yes	Yes	Yes	Yes	No	Yes	No
	CS1D	Yes	Yes	Yes	Yes	Yes	No	Yes	No
CJ series	CJ1H	Yes	Yes	Yes	Yes	Yes	No	Yes	No
	CJ1G	Yes	Yes	Yes	Yes	Yes	No	Yes	No
	CJ1M	Yes	Yes	Yes	Yes	Yes	No	Yes	No
	CJ2H	Yes	Yes	Yes	Yes	Yes	Yes	Yes	No
	CJ2M	Yes	Yes	Yes	Yes	Yes	Yes	Yes	No
CP series	CP1H	Yes	Yes	Yes	Yes *1	Yes	No	No	No
	CP1L	Yes	Yes	Yes	Yes *1	Yes	No	No	No
	CP1E	No	No	No	Yes *1	Yes	No	No	No
NJ series	NJ5/NJ3/NJ1	No	Yes *2	No	No	Yes *3	Yes	No	Yes
NX Series	NX7/NX1/NX1P	No	No	No	No	No	Yes	No	Yes

Note: Including models whose production were discontinued.

*1. The SPMA relaying a PLC is not supported.

*2. Only Device Monitor function is supported. Monitoring function that uses tags (variables) is not supported.

*3. The SAP for CJ-series Special I/O Units and CPU Bus Units that can be used with NJ-series Controller is supported.

*4. Sysmac Studio version 1.02 or higher (CX-Designer version 3.41 or higher) is required.

Connectable Inverters

Series	Communication Unit	Connection
3G3MX2-V1	(Use the RS-485 terminal on the Inverter)	RS-485 (2-wire) 1:N
3G3JX	(Use the RS-485 connector on the Inverter)	
3G3RX-V1	(Use the RS-485 terminal on the Inverter)	

Connectable Temperature Controllers

The following Temperature Controllers can be connected directly to an NS-series PT*.

Unit name	Series	Model	Remarks
Modular Temperature Controller	EJ1	EJ1-EDU End Unit	
Modular Temperature Controller	E5ZN	E5ZN-SCT24S Terminal Unit	
Digital Controller	E5AR	E5AR-□□□□□□□□-FLK	
	E5ER	E5ER-□□□□□□□□-FLK	
Temperature Controller (Digital Controller)	E5AN/E5EN/E5CN (Basic Model)	E5CN-□□□□□T-FLK Multi-input (Thermocouple/Resistance Thermometer) Type	SAP screens are available.
		E5CN-□□□□□L-FLK Analog Input Type	
		E5EN-□□□□□T-FLK Multi-input (Thermocouple/Resistance Thermometer) Type	
		E5EN-□□□□□L-FLK Analog Input Type	
		E5AN-□□□□□T-FLK Multi-input (Thermocouple/Resistance Thermometer) Type	
		E5AN-□□□□□L-FLK Analog Input Type	
	E5AN-H/E5EN-H/E5CN-H (Advanced Model)	E5CN-H□□□□□□□□-FLK Universal-input Model	
		E5EN-H□□□□□□□□-FLK Universal-input Model	
		E5AN-H□□□□□□□□-FLK Universal-input Model	
	E5GN	E5GN-□□□TC-FLK Thermocouple Input Type	
		E5GN-□□□P-FLK Resistance Thermometer Input Type	

Note: Including models whose production were discontinued.

* The NS-Runtime cannot be connected directly to a Temperature Controller.

Design

Startup/Operation

Maintenance

NS-Runtime

Hand-held PT

Features

Network

System Configuration

Ordering Information

Specifications

Connecting to Another Company's PLC

Manufacturer	Series	CPU	Communication Unit/Adapter/Board	Connection diagram		
Mitsubishi Electric	A Series	A1SHCPU A2USCPU A2USHCPU-S1	Computer Link Unit A1SJ71UC24-R□ A1SJ71UC24-PRF	RS-232C, RS422A/485 *1	1:1	
		A2ACPU	Computer Link Unit AJ71UC24			
	FX Series	FX0N FX1S FX1N FX1NC FX2N FX3UC FX3G	Communication special adapter FX3U-232-ADP FX2NC-232ADP FX0N-232-ADP	RS-232C, RS422A/485 *1	1:1	
			Communication expansion board FX□□-232-BD			
	Q/QnA Series	Q00CPU Q01CPU	RS-232C port on the CPU Module	RS-232C	1:1	
		Q00CPU Q01CPU Q00JCPU Q02CPU Q02HCPU Q06HCPU Q12HCPU Q25HCPU Q03UDCPU Q06UDHCPU Q13UDHCPU	Serial Communications Module QJ71C24N-R2 QJ71C24N-R4 QJ71C24N	RS-232C, RS-485 (4-wire) *2	1:N	
		Q2ASCPU Q2ASCPU-S1 Q2ASHCPU Q2ASHCPU-S1	Serial Communications Module A1SJ71QC24N			
	Yokogawa Electric	FA-M3(R) Series	F3SC23-1F F3SP21-0N F3SP28-3S F3SP58-6S F3SP67-6S	CPU built-in RS-232C port	RS-232C	1:1
				Personal Computer Link Module F3LC11-1F F3LC12-1F F3LC11-2F	RS-232C, RS-422A/485 *1	
Siemens	S7-300 Series	CPU313 CPU315-2DP CPU317-2PN/DP	SIMATIC S7 HMI Adapter 6ES7 972-0CA1□-0XA0	RS-232C	1:1	
Rockwell (Allen-Bradley)	SLC500	SLC5/03 SLC5/04 SLC5/05	RS-232C port on the CPU Module	RS-232C	1:1	
	MicroLogix	MicroLogix 1500	RS-232C port on the CPU Module	RS-232C	1:1	
	ControlLogix	Logix5555	RS-232C port on the CPU Module	RS-232C	1:1	
	CompactLogix	1769-L31	RS-232C port on the CPU Module	RS-232C	1:1	
	PLC-5	PLC-5/20	RS-232C port or RS-485 port on the CPU Module	RS-232C/RS-485 (4-wire)	1:N	

*1. To connect using RS-422A/485, an RS-232C/422A converter (e.g. NS-AL002, CJ1W-CIF11) is required.

*2. To connect using RS-485, an RS-232C/422A converter (e.g. NS-AL002, CJ1W-CIF11) is required.

Up to 32 sequencers can be connected when using RS-485.

Component Names and Options

NS15

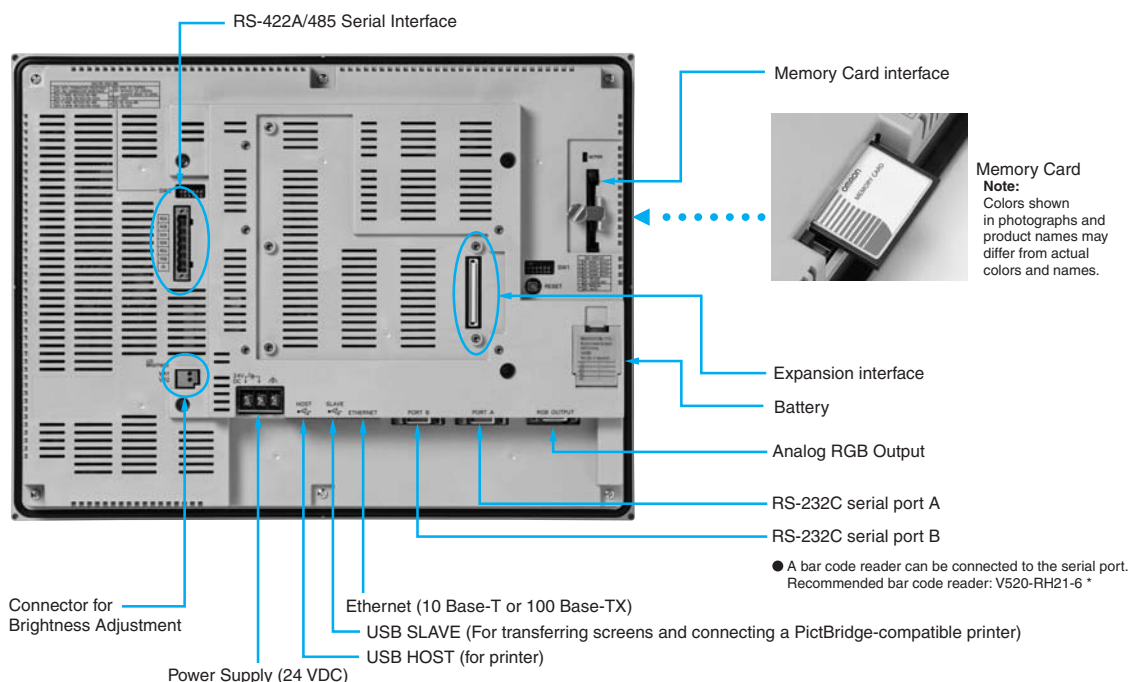

NS12/10

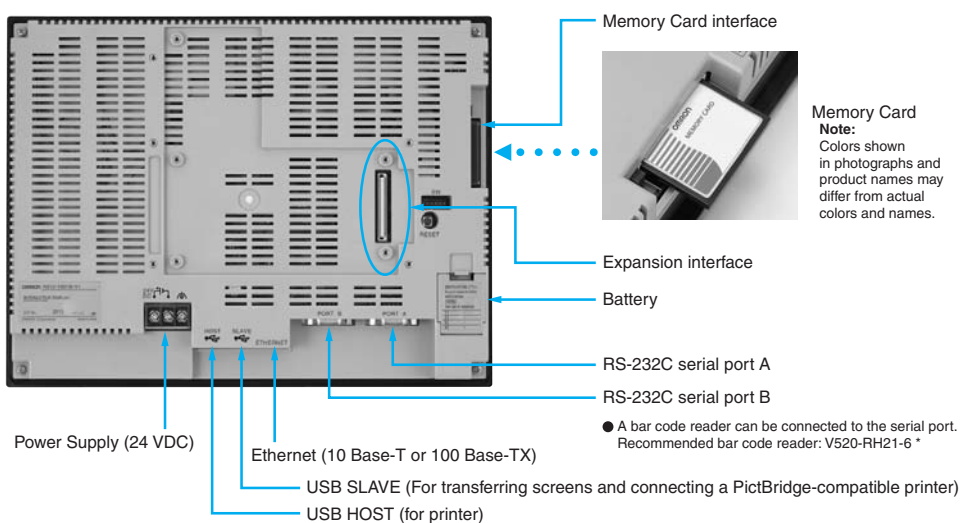

NS8

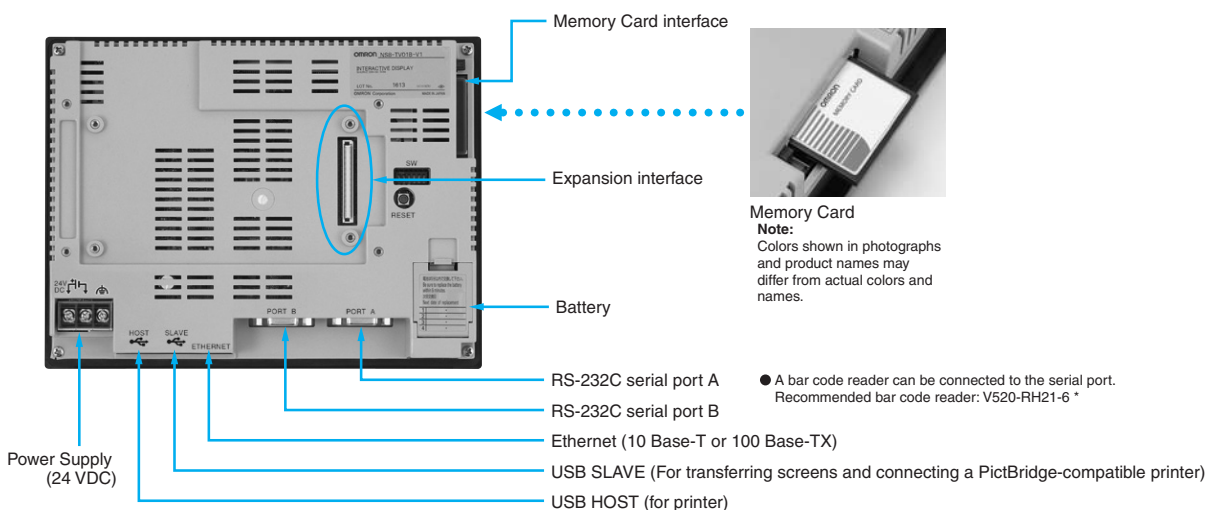

* Bar Code Reader (V520-RH21-6) was discontinued at the end of August 2016.

Design

Startup/Operation

Maintenance

NS-Runtime

Hand-held PT

Features

Network

System Configuration

Ordering Information

Specifications

NS5

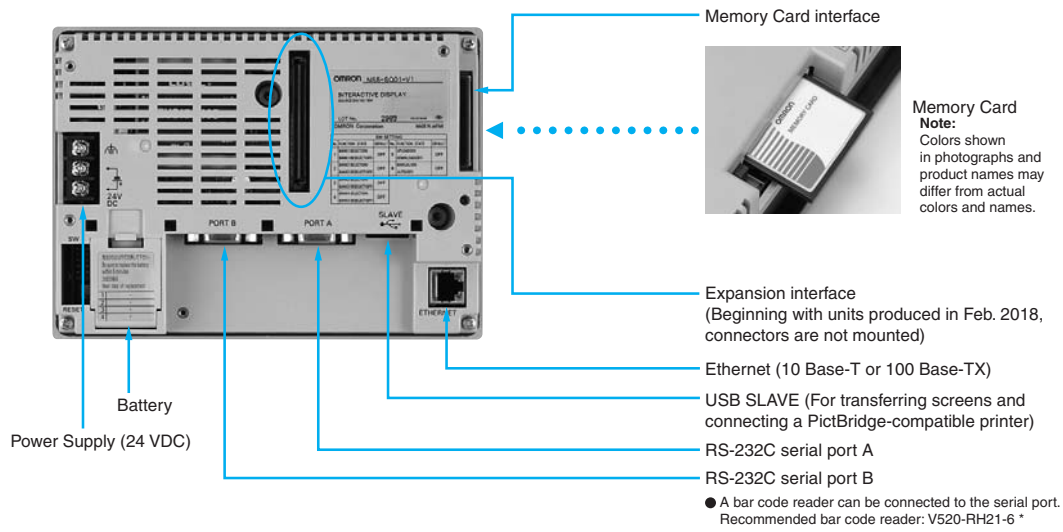

* Bar Code Reader (V520-RH21-6) was discontinued at the end of August 2016.

NSH5

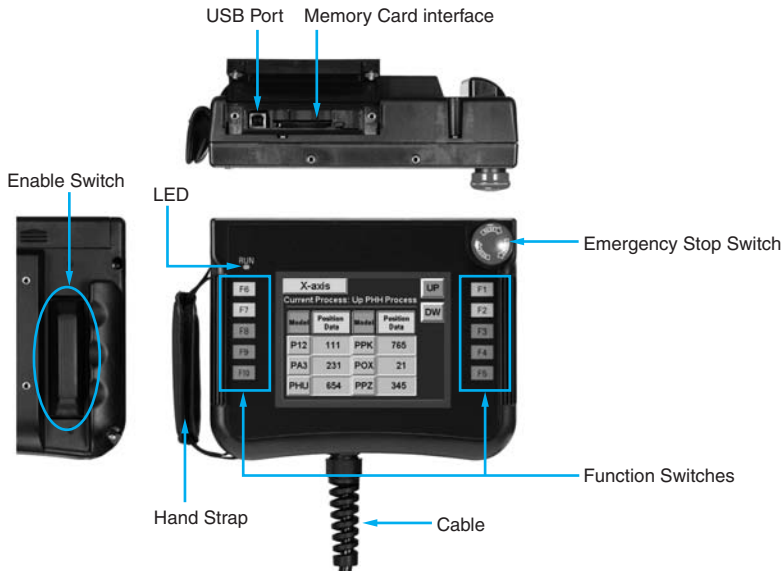

Optional Products

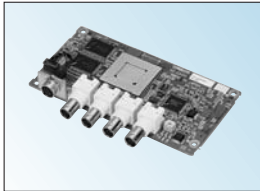

Video Input Unit
NS-CA001 (with Cover)

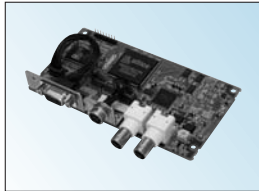

RGB/Video Input Unit
NS-CA002 (with Cover)

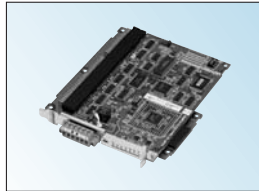

Controller Link Interface Unit
NS-CLK21 (with Cover)

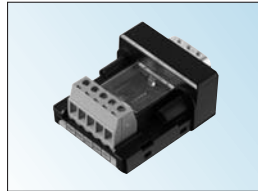

RS-422A Adapter
CJ1W-CIF11

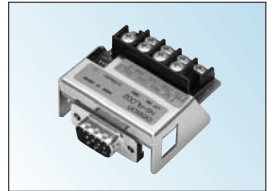

RS-232C/RS-422A
Conversion Unit
NS-AL002



Communications Cable
XW2Z-S002

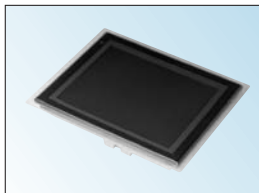

Protective Cover/Anti-reflection
Sheet for NS-series PT
NS-KBA0 (N)
NT30/NT31C-KBA05 (N)



USB Serial Conversion Cable
CS1W-CIF31



USB relay cable
(IP65 oil-proof type)
NS-USBEXT-1M

Dimensions

NS15

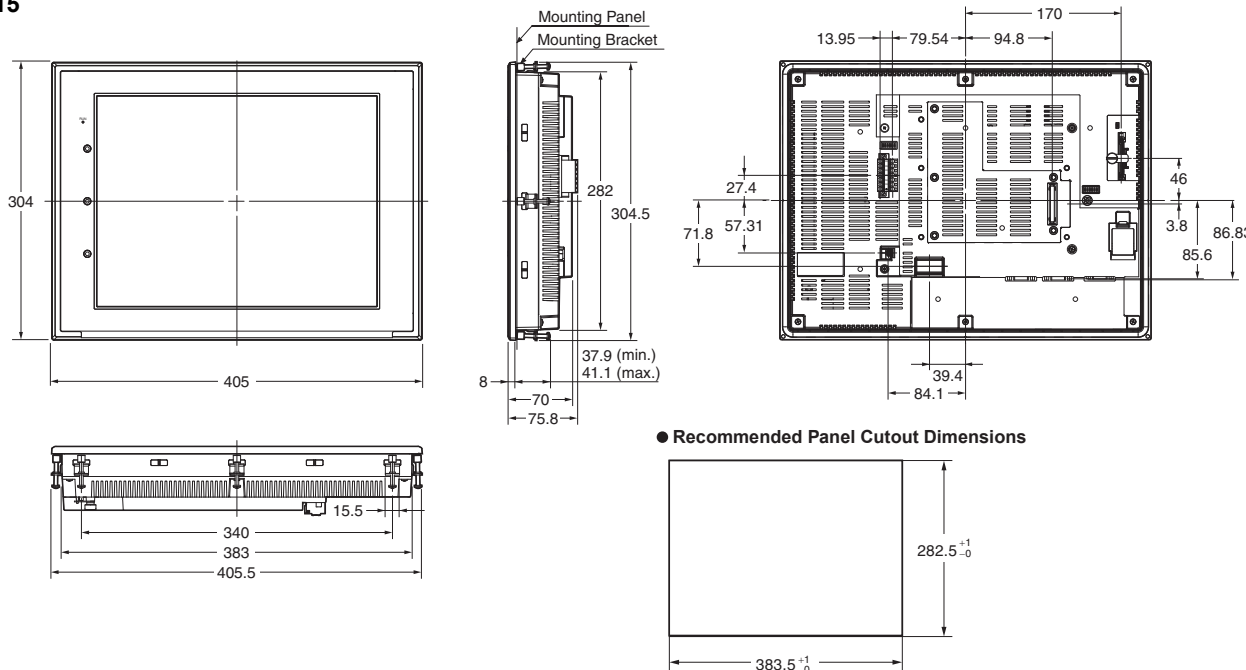

NS12/10

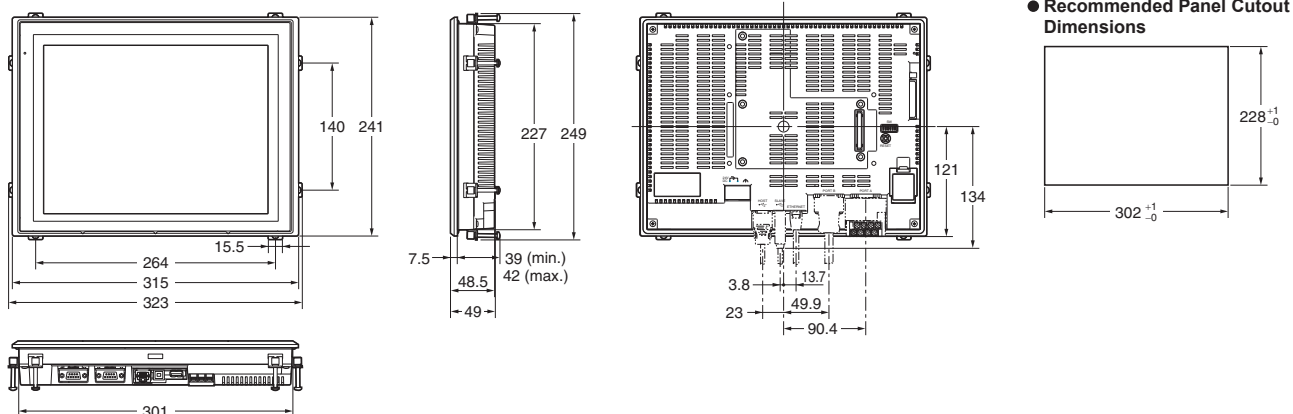

NS8

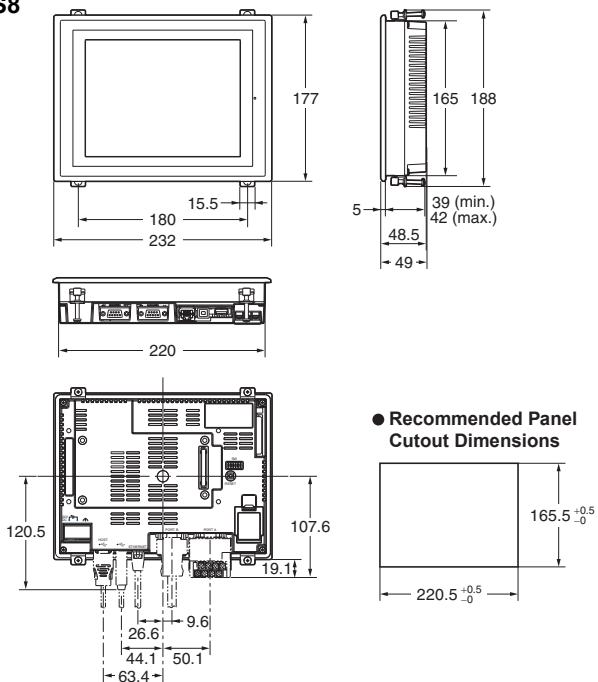

NS5

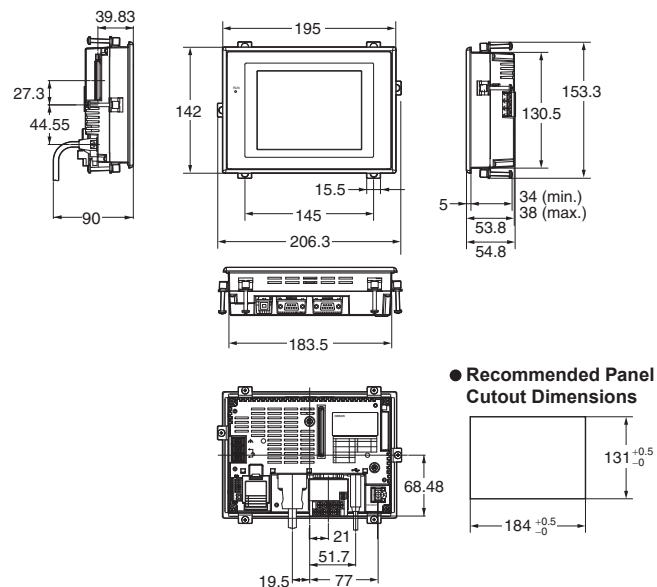

Hand-held NS5

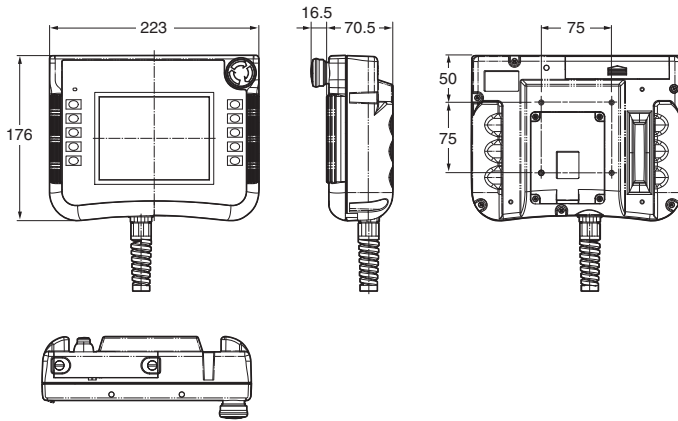

NS-CA001 Video Input Unit

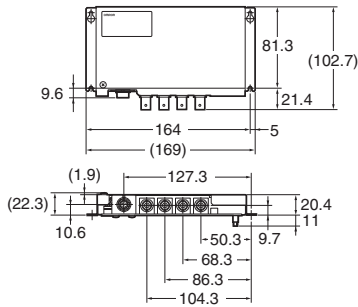

NS-CA002 Video Input Unit

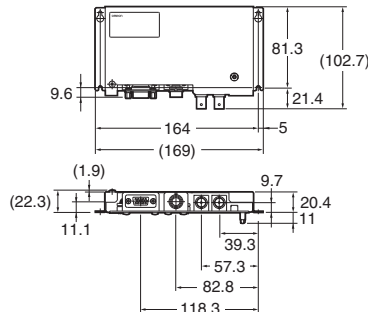

NS-CLK21 Controller Link Interface Unit

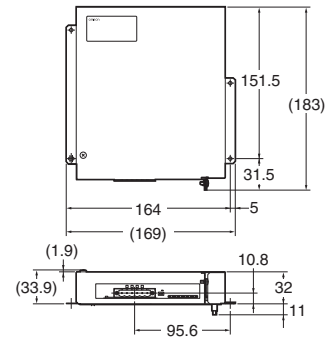

Related Manuals

Cat. No.	Model	Manual
V083	NS15/NS12/NS10/NS8/NS5	NS-Series Programmable Terminals SETUP MANUAL
V073	NS15/NS12/NS10/NS8/NS5	NS-Series Programmable Terminals PROGRAMMING MANUAL
V099	NS-CXDC1-V3	CX-Designer Ver.3.0 USER'S MANUAL
V082	NS	NS-Series Ladder Monitor OPERATION MANUAL (Ladder Monitor I/O Comment Extracting Tool)
V086	NS-CA002	NS-Series RGB and Video Input Unit OPERATION MANUAL
V090	NSH5	NSH5-Series Hand-held Programmable Terminal OPERATION MANUAL
V098	NS15/NS12/NS10/NS8/NS5	NS-Series Programmable Terminals HOST CONNECTION MANUAL (Host Link) OPERATION MANUAL
V085	NS15/NS12/NS10/NS8/NS5	NS-Series Programmable Terminals HOST CONNECTION MANUAL
V092	NS15/NS12/NS10/NS8/NS5	NS-Series Programmable Terminals HOST CONNECTION MANUAL Multivendor Connection
V075	NS15/NS12/NS10/NS8/NS5	NS-Series Programmable Terminals Macro Reference
V093	NS-NSRCL□□	NS-NSRCL□□ NS-Runtime Software USERS MANUAL

Read and Understand This Catalog

Please read and understand this catalog before purchasing the products. Please consult your OMRON representative if you have any questions or comments.

Warranty and Limitations of Liability

WARRANTY

OMRON's exclusive warranty is that the products are free from defects in materials and workmanship for a period of one year (or other period if specified) from date of sale by OMRON.

OMRON MAKES NO WARRANTY OR REPRESENTATION, EXPRESS OR IMPLIED, REGARDING NON-INFRINGEMENT, MERCHANTABILITY, OR FITNESS FOR PARTICULAR PURPOSE OF THE PRODUCTS. ANY BUYER OR USER ACKNOWLEDGES THAT THE BUYER OR USER ALONE HAS DETERMINED THAT THE PRODUCTS WILL SUITABLY MEET THE REQUIREMENTS OF THEIR INTENDED USE. OMRON DISCLAIMS ALL OTHER WARRANTIES, EXPRESS OR IMPLIED.

LIMITATIONS OF LIABILITY

OMRON SHALL NOT BE RESPONSIBLE FOR SPECIAL, INDIRECT, OR CONSEQUENTIAL DAMAGES, LOSS OF PROFITS OR COMMERCIAL LOSS IN ANY WAY CONNECTED WITH THE PRODUCTS, WHETHER SUCH CLAIM IS BASED ON CONTRACT, WARRANTY, NEGLIGENCE, OR STRICT LIABILITY.

In no event shall the responsibility of OMRON for any act exceed the individual price of the product on which liability is asserted.

IN NO EVENT SHALL OMRON BE RESPONSIBLE FOR WARRANTY, REPAIR, OR OTHER CLAIMS REGARDING THE PRODUCTS UNLESS OMRON'S ANALYSIS CONFIRMS THAT THE PRODUCTS WERE PROPERLY HANDLED, STORED, INSTALLED, AND MAINTAINED AND NOT SUBJECT TO CONTAMINATION, ABUSE, MISUSE, OR INAPPROPRIATE MODIFICATION OR REPAIR.

Application Considerations

SUITABILITY FOR USE

OMRON shall not be responsible for conformity with any standards, codes, or regulations that apply to the combination of products in the customer's application or use of the products.

At the customer's request, OMRON will provide applicable third party certification documents identifying ratings and limitations of use that apply to the products. This information by itself is not sufficient for a complete determination of the suitability of the products in combination with the end product, machine, system, or other application or use.

The following are some examples of applications for which particular attention must be given. This is not intended to be an exhaustive list of all possible uses of the products, nor is it intended to imply that the uses listed may be suitable for the products:

- Outdoor use, uses involving potential chemical contamination or electrical interference, or conditions or uses not described in this catalog.
- Nuclear energy control systems, combustion systems, railroad systems, aviation systems, medical equipment, amusement machines, vehicles, safety equipment, and installations subject to separate industry or government regulations.
- Systems, machines, and equipment that could present a risk to life or property.

Please know and observe all prohibitions of use applicable to the products.

NEVER USE THE PRODUCTS FOR AN APPLICATION INVOLVING SERIOUS RISK TO LIFE OR PROPERTY WITHOUT ENSURING THAT THE SYSTEM AS A WHOLE HAS BEEN DESIGNED TO ADDRESS THE RISKS, AND THAT THE OMRON PRODUCTS ARE PROPERLY RATED AND INSTALLED FOR THE INTENDED USE WITHIN THE OVERALL EQUIPMENT OR SYSTEM.

PROGRAMMABLE PRODUCTS

OMRON shall not be responsible for the user's programming of a programmable product, or any consequence thereof.

Disclaimers

CHANGE IN SPECIFICATIONS

Product specifications and accessories may be changed at any time based on improvements and other reasons.

It is our practice to change model numbers when published ratings or features are changed, or when significant construction changes are made. However, some specifications of the products may be changed without any notice. When in doubt, special model numbers may be assigned to fix or establish key specifications for your application on your request. Please consult with your OMRON representative at any time to confirm actual specifications of purchased products.

DIMENSIONS AND WEIGHTS

Dimensions and weights are nominal and are not to be used for manufacturing purposes, even when tolerances are shown.

PERFORMANCE DATA

Performance data given in this catalog is provided as a guide for the user in determining suitability and does not constitute a warranty. It may represent the result of OMRON's test conditions, and the users must correlate it to actual application requirements. Actual performance is subject to the OMRON Warranty and Limitations of Liability.

ERRORS AND OMISSIONS

The information in this document has been carefully checked and is believed to be accurate; however, no responsibility is assumed for clerical, typographical, or proofreading errors, or omissions.

Note: Do not use this document to operate the Unit.

OMRON Corporation Industrial Automation Company
Kyoto, JAPAN

Contact: www.ia.omron.com

Regional Headquarters

OMRON EUROPE B.V.

Wegalaan 67-69, 2132 JD Hoofddorp
The Netherlands
Tel: (31)2356-81-300/Fax: (31)2356-81-388

OMRON ELECTRONICS LLC

2895 Greenspoint Parkway, Suite 200
Hoffman Estates, IL 60169 U.S.A.
Tel: (1) 847-843-7900/Fax: (1) 847-843-7787

OMRON ASIA PACIFIC PTE. LTD.

No. 438A Alexandra Road # 05-05/08 (Lobby 2),
Alexandra Technopark,
Singapore 119967
Tel: (65) 6835-3011/Fax: (65) 6835-2711

OMRON (CHINA) CO., LTD.

Room 2211, Bank of China Tower,
200 Yin Cheng Zhong Road,
PuDong New Area, Shanghai, 200120, China
Tel: (86) 21-5037-2222/Fax: (86) 21-5037-2200

Authorized Distributor:

© OMRON Corporation 2011-2018 All Rights Reserved.
In the interest of product improvement,
specifications are subject to change without notice.

CSM_12_7_0918
Cat. No. V405-E1-16

1018 (1206)

X-ON Electronics

Largest Supplier of Electrical and Electronic Components

Click to view similar products for [Controllers](#) category:

Click to view products by [Omron](#) manufacturer:

Other Similar products are found below :

[61FGPN8DAC120](#) [CV500SLK21](#) [70177-1011](#) [F03-03 HAS C F03-31](#) [81550401](#) [FT1A-C12RA-W](#) [88981106](#) [H2CAC24A](#) [H2CRSAC110B](#)
[R88A-CRGB003CR-E](#) [R88ARR080100S](#) [R88A-TK01K](#) [DCN1-1](#) [DRT2ID08C](#) [DTB4896VRE](#) [DTB9696CVE](#) [DTB9696LVE](#) [E53-AZ01](#)
[E53E01](#) [E53E8C](#) [E5C4Q40J999FAC120](#) [E5CWLQ1TCAC100240](#) [E5GNQ03PFLKACDC24](#) [B300LKL21](#) [NSCXDC1V3](#) [NSH5-232CW-3M](#)
[NT20SST122BV1](#) [NV-CN001](#) [OAS-160-N](#) [C40PEDRA](#) [K31S6](#) [K33-L1B](#) [K3MA-F 100-240VAC](#) [K3TX-AD31A](#) [89750101](#) [L595020](#)
[SRM1-C02](#) [SRS2-1](#) [FT1A-C14SA-S](#) [G32X-V2K](#) [26546803](#) [26546805](#) [PWRA440A](#) [CPM1AETL03CH](#) [CV500SLK11](#) [3G2A5BI081](#)
[3G2A5IA122](#) [3G2A5LK010E](#) [3G2A5OA223](#)