

1/16 DIN Analog-Set Timer with Many Time Ranges, Operating Modes, and Aesthetics Options

- Field-selectable time ranges from 0.05 second to 300 hours
- Choose 6- or 2-function models to handle most applications
- Wide range AC supply voltage models (100 to 240 VAC) fits most applications and reduces spare parts inventories
- Three external signal inputs for remote control of the timer
- Short, 80 mm (3.15 inch) panel mounting depth with socket allows space-efficient control panel design
- Choice of light gray, medium gray or black panel covers to match panel aesthetics

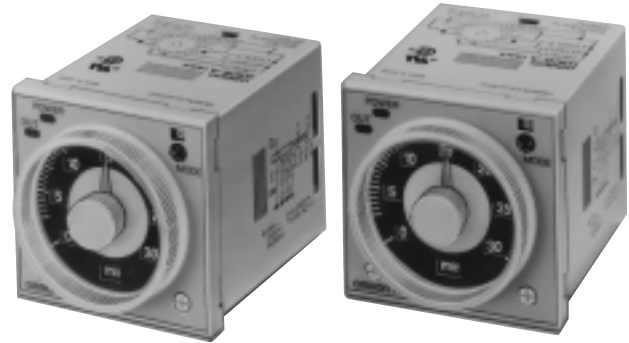

Ordering Information

■ TIMERS

Timing functions		ON-delay, Repeat cycle (B,B2). Signal ON/OFF delay, Signal OFF-delay, Interval	ON-delay, Interval
Terminal form		11-pin round	8-pin round
Contact output	100 to 240 VAC, 50/60 Hz	H3CR-A-AC100-240	H3CR-A8-AC100-240
Transistor output	12 VDC	H3CR-A-DC12	H3CR-A8-DC12
	24 VAC/VDC	H3CR-A-AC/DC24	H3CR-A8-AC/DC24
	12 VDC	H3CR-AS-DC12	H3CR-A8S-DC12
	24 VAC/VDC	H3CR-AS-AC/DC24	H3CR-A8S-AC/DC24
Instantaneous output contact	100 to 240 VAC, 50/60 Hz	—	H3CR-A8EL-AC120-240
	24 VAC/VDC	—	H3CR-A8E-AC/DC24

■ ACCESSORIES

Description		Part number	
Sockets	H3CR-A, H3CR-AS timers	Bottom surface or track mounting, top screw terminals Back mounting, for use with Y92F-30 mounting adapter, bottom screw terminals.	P2CF-11 P3GA-11
	H3CR-A8, H3CR-A8S timers	Bottom surface or track mounting, top screw terminals Back mounting, for use with Y92F-30 mounting adapter, bottom screw terminals.	P2CF-08 P3G-08
		Panel mounting adapter	Fits behind panel, ideal for side-by-side installation. Use P3G□□ sockets. For use with products with body length measurements of 66 mm For use with products with body length measurements of 66 mm For use with products with body length measurements of 78 mm For use with products with body length measurements of 78 mm
	Protective cover	Hard plastic cover protects against dust, dirt and water; not for use with panel covers.	Y92A-48B
Panel covers	Light gray (Munsell No. 5Y7/1) to match case Medium gray (Munsell No. 5Y5/1) Black (Munsell No. N1.5)	Y92P-48GL Y92P-48GM Y92P-48GB	
	Time setting rings	Used to lock in a single setting; one ring, can be used with Y92P panel covers. Used to lock in a setting range; two rings, can be used with Y92P panel covers.	Y92S-27 Y92S-28
		Mounting track	DIN rail, 50 cm (1.64 ft) length DIN rail, 1 m (3.28 ft) length End plate Spacer

RANGE SELECTION

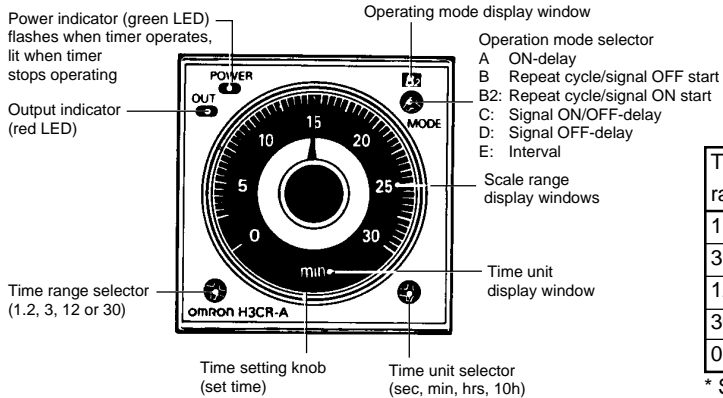

Time range	Time units			
	sec(onds)	min(utes)	hrs (hours)	10h (10 hours)
1.2	0.05 to 1.2	0.12 to 1.2	0.12 to 1.2	1.2 to 12
3	0.3 to 3	0.3 to 3	0.3 to 3	3 to 30
12	1.2 to 12	1.2 to 12	1.2 to 12	12 to 120
30	3 to 30	3 to 30	3 to 30	30 to 300
0	Instantaneous output*			

* Set to time setting knob below zero.

Specifications

Part number		H3CR-A	H3CR-AS	H3CR-A8	H3CR-A8S	H3CR-A8EL/H3CR-A8E
Supply voltage	AC	24 V or 100 to 240 VAC, 50/60 Hz				
	DC	12 V or 24 V				
Operating voltage	AC	85% to 110% of rated supply voltage				
	DC	90% to 110% of rated supply voltage at 12 VDC				
Power consumption	AC	10 VA				
	AC/DC	1.5 VA (AC), 0.8 W (DC)				
	DC	1.3 W				
Timing functions		ON-delay, Repeat cycle signal OFF start, Repeat cycle signal ON start, Signal ON/OFF delay, Signal OFF-delay, Interval		ON-delay, Interval		
Start, Reset, Gate inputs H3CR-A, H3CR-AS		No-voltage inputs ON impedance: 1 kΩ max. ON residual voltage: 1 V max. OFF impedance: 100 kΩ min.		—		
Control output	Type	DPDT relay	Transistor (NPN/PNP)	DPDT relay	Transistor (NPN/PNP)	SPDT relay (instantaneous contact)
	Max. load	5 A, 250 VAC (p.f.=1)	100 mA, 30 VDC	5 A, 250 VAC (p.f.=1)	100 mA, 30 VDC	5 A, 250 VAC (p.f. = 1)
	Min. load	10 mA, 5 VDC	10 mA, 5 VDC	10 mA, 5 VDC	10 mA, 5 VDC	10 mA, 5 VDC
	Residual voltage	—	2 V max.	—	2 V max.	—
Repeat accuracy		±0.3% full scale max., except in 1.2 s range ±0.3% ±10 ms				
Setting error		±5% full scale ±0.05 s max.				
Resetting system		Power OFF; external, self-resetting		Power OFF		
Resetting time		0.1 s max.				
Indicators		Power ON indicator (green LED), Output ON indicator (red LED)				
Materials		Plastic case (light gray Munsell 5Y7/1) and knob (clear)				
Mounting		Panel, track or surface depending on socket selected				
Connections		11-pin round socket		8-pin round socket		
Weight		Approx. 90 g (3.17 oz.)				Approx 110 g (3.9 oz.)
Approvals	UL	Recognized, File Number E41515				
	CSA	Certified, File Number LR22310				
Ambient temperature	Operating	-10° to 55°C (14° to 131°F)				
	Storage	-25° to 65°C (-13° to 149°F)				
Humidity		35% to 85%				
Vibration	Mechanical durability	10 to 55 Hz with 0.75 mm (0.03 in) double amplitude each in three directions				
	Malfunction durability	10 to 55 Hz with 0.5 mm (0.02 in) double amplitude each in three directions				
Shock	Mechanical durability	100 G each in three directions				
	Malfunction durability	10 G each in three directions				
Variation due to voltage change		±0.5% full scale max.				
Variation due to temperature change		±2% full scale max.				
Insulation resistance		100 MΩ minimum at 500 VDC				

Dielectric strength		2,000 VAC, 50/60 Hz for 1 minute between current-carrying metal parts and non-current-carrying metal parts 2,000 VAC, 50/60 Hz for 1 minute between control output terminals and operating circuit 1,000 VAC, 50/60 Hz for 1 minute between contacts not located next to each other
Service life	Electrical	100,000 operations minimum at maximum ratings

Engineering Data

ELECTRICAL SERVICE LIFE

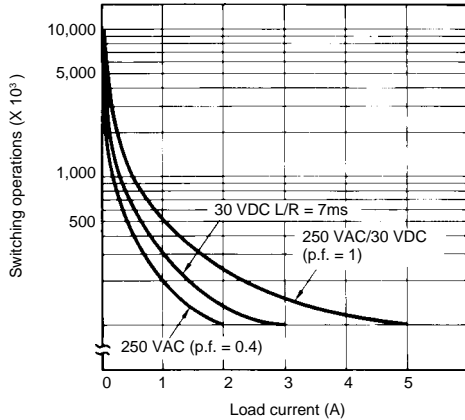

Timing Charts

In the schematic diagrams, each **thick line** indicates the external wiring; shaded areas show internal connections.

H3CR-A, H3CR-AS (SIX-FUNCTION TIMERS)

Mode A ON-Delay

Signal Start/Signal Reset

Power is applied continuously. Timing starts at the leading edge of the start input. The output relay is energized when the accumulated time equals the set time. Subsequent start signals during or after timing will not be accepted. The output relay or transistor will remain energized until a reset input is applied or power is interrupted. The minimum signal input is 0.05 second.

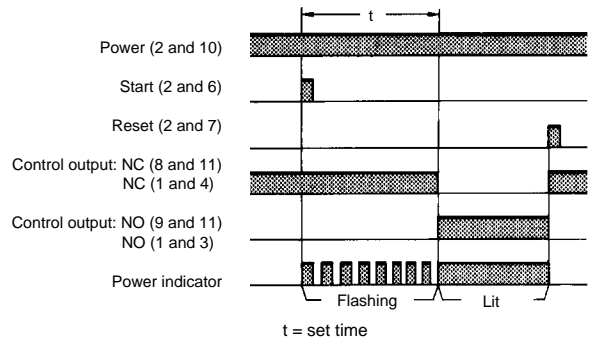
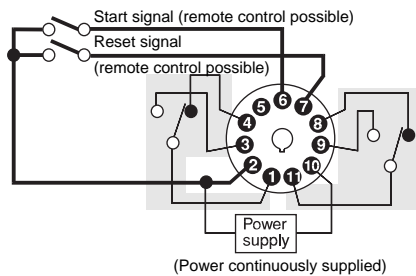

Power-ON Start/ Power-OFF Reset

The start terminals are connected. Timing starts when power is applied. The output is energized when the accumulated time equals the set time. The output relay or transistor remains energized until power is disconnected or a reset input is applied. The minimum resetting time is 0.1 second.

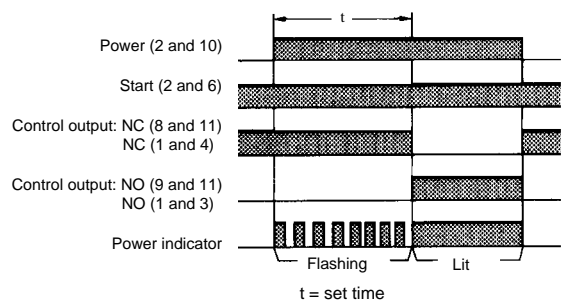
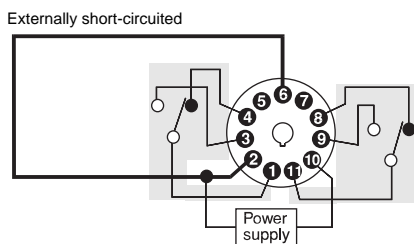

In the schematic diagrams, each **thick line** indicates the external wiring; shaded areas show internal connections.

Cumulative Timing Using the Gate Input with ON-Delay

When the gate signal is closed, timing is temporarily stopped. When the gate signal opens, timing resumes at the point of interruption. The gate input terminal permits the timer to sum up times t_1 and t_2 as shown in the timing chart.

Gate signal (The operation is interrupted with the gate signal if the Timer detects an abnormal signal.)

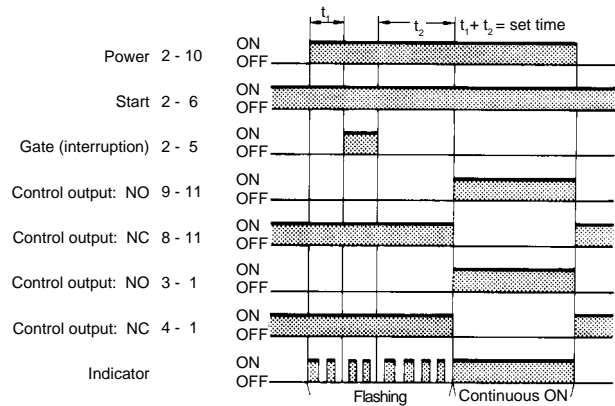
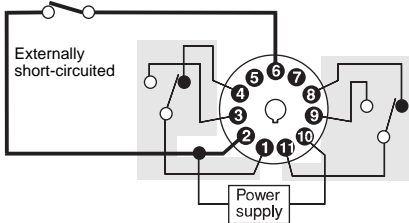

Modes B and B2 Repeat Cycle

Signal Start/Signal Reset

Power is continuously applied. The ON/OFF cycle is initiated at the leading edge of the start input. In Mode B the output relay or transistor will be OFF for the set time and then ON for the set time, creating an operation pattern of OFF/ON/OFF. In Mode B2 the output relay or transistor will turn ON for the set time and then OFF for the set time, creating an operation pattern of ON/OFF/ON. This cycle will be repeated until a reset input is applied or power is disconnected. The minimum signal input time is 0.05 second.

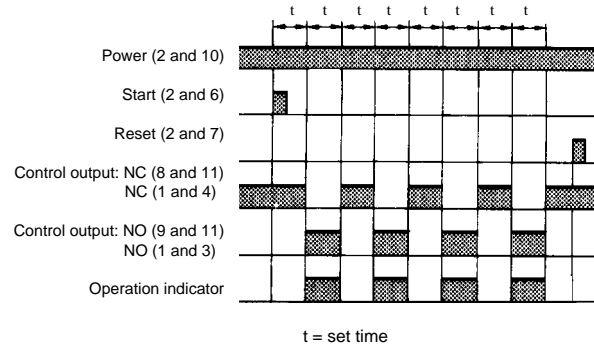
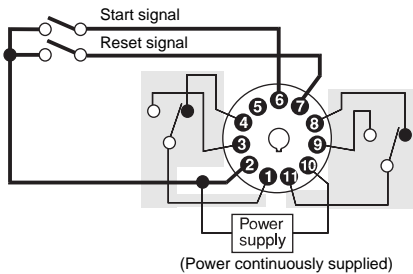

Power-ON Start/Power OFF Reset

The start terminals are connected. Timing starts when power is applied. The output relay or transistor operates according to mode B (OFF/ON/OFF pattern) or mode B2 (ON/OFF/ON pattern), whichever is set. The cycle repeats until a reset input is applied or power is disconnected.

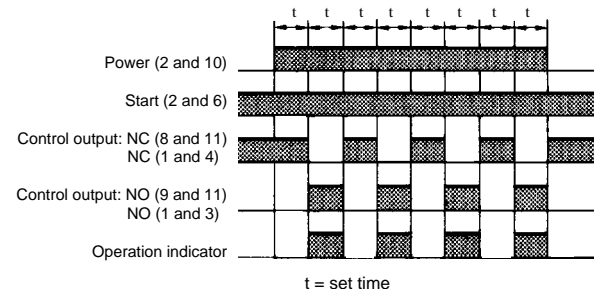
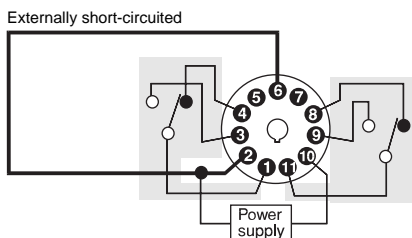

In the schematic diagrams, each **thick line** indicates the external wiring; shaded areas show internal connections.

Mode C Signal ON/OFF Delay

Signal ON/OFF Start/Instantaneous Operation/Time-Limit Reset

Power is continuously applied. The first timing cycle begins when the input signal is applied, the second when it is removed. The output relay or transistor is energized when the lapsed time from the first timing cycle equals the set point. The output remains energized until the lapsed time of the second timing cycle equals the set point. The minimum signal input time is 0.05 second.

Start signal (The operation starts with the signal ON or OFF)

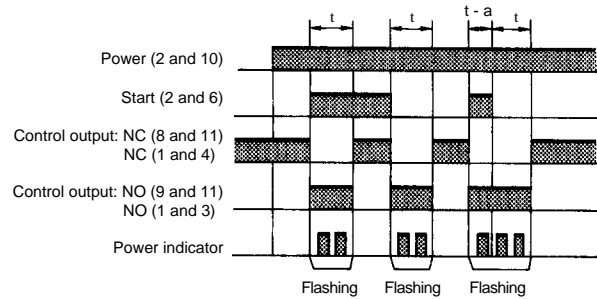
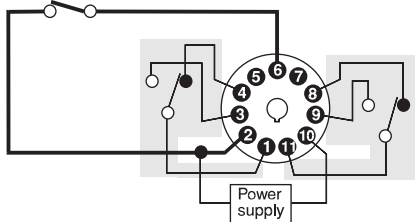

t = set time $t-a$ = less than set time

Power ON Start/Instantaneous Operation/Time-Limit Reset

The timing cycle starts when power is applied. When the timer reaches set point, the output status changes and holds that status until power turns OFF to reset the timer. Minimum reset time is 0.1 second.

Start signal (NC to NO)

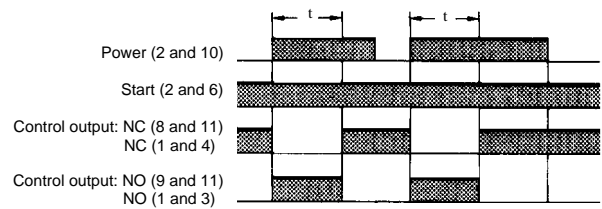
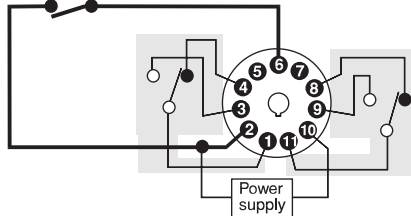

t = set time

Mode D Signal OFF-Delay

Signal Start/Instantaneous Operation/Time-Limit Reset

Power is continuously applied. The output relay is energized at the leading edge of the start input. Timing starts at the trailing edge of the start input. The output relay is de-energized when the accumulated time equals the set time. The minimum signal input time is 0.05 second.

Start signal (NO to NC to NO)

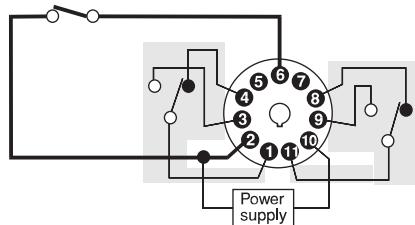

(Power continuously supplied)

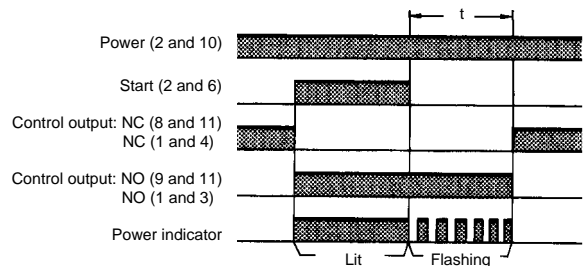

t = set time

In the schematic diagrams, each **thick line** indicates the external wiring; shaded areas show internal connections.

Mode D continued

Power-ON Start/Instantaneous Operation/Time-Limit Reset

Power is continuously applied. The output relay is energized at the leading edge of the start input. Timing starts at the trailing edge of the start input. The output is de-energized when the accumulated time equals the set time. The minimum reset time is 0.1 second.

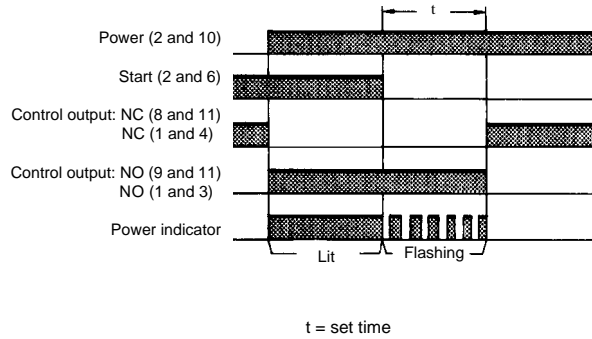
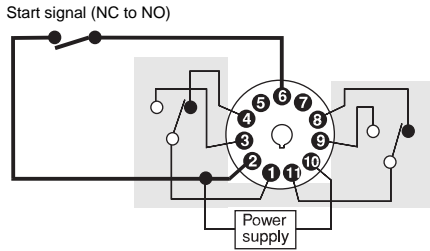

Mode E Interval

Signal Start/Instantaneous Operation/Time-Limit Reset

Timing begins on the leading edge of the start signal. The control output is only energized during timing. The timer is reset when a reset signal is applied.

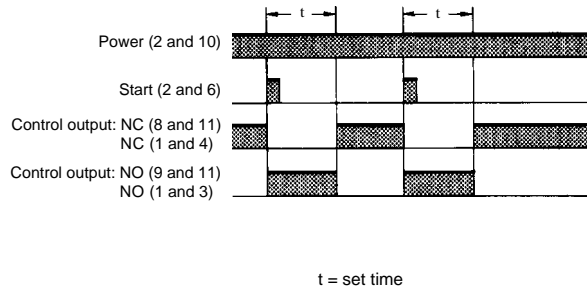
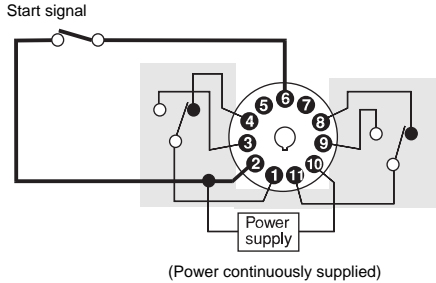

Power ON Start/Instantaneous Operation/Time-Limit Reset

Timing begins on the leading edge of the start signal. The control output is only energized during timing. The timer is reset when power is interrupted.

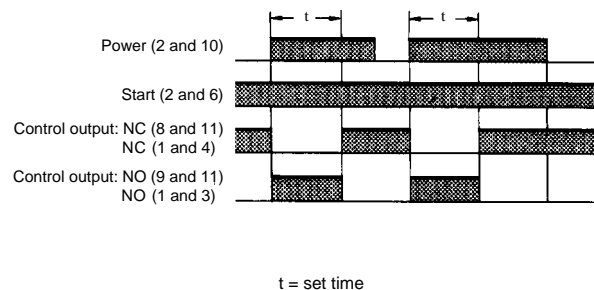
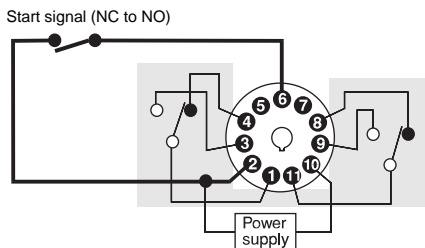

In the schematic diagrams, each **thick line** indicates the external wiring; shaded areas show internal connections.

■ H3CR-A8 TWO-FUNCTION TIMER, DPDT CONTACT OUTPUT

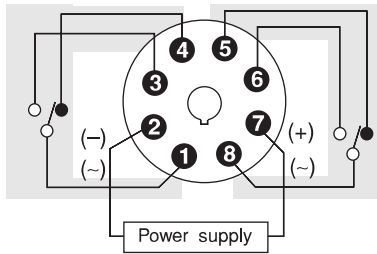

Power-ON Start/ Power-OFF Reset

Timing starts when power is applied. The output is energized when the accumulated time equals the set time. The output relay remains energized until power is disconnected. The minimum resetting time is 0.1 second.

Power ON Start/ Instantaneous Operation/Time-Limit Reset

Timing begins when power is applied. The control output is only energized during timing. The timer is reset when power is interrupted.

Mode A ON-Delay

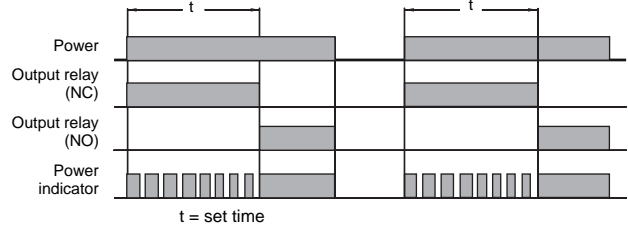

Mode E Interval

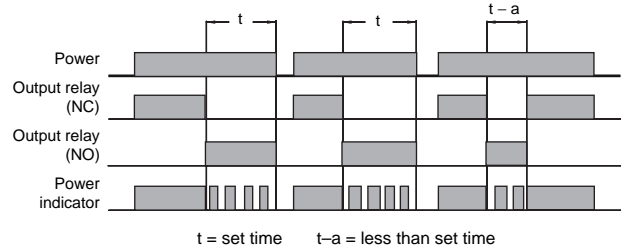

■ H3CR-A8S TWO-FUNCTION TIMER, TRANSISTOR OUTPUT

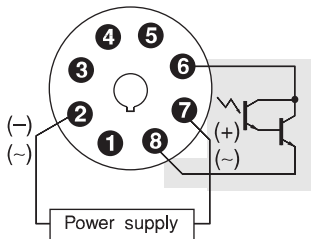

Power-ON Start/ Power-OFF Reset

Timing starts when power is applied. The output is energized when the accumulated time equals the set time. The output transistor remains energized until power is disconnected. The minimum resetting time is 0.1 second.

Power ON Start/ Instantaneous Operation/Time-Limit Reset

Timing begins when power is applied. The control output is only energized during timing. The timer is reset when power is interrupted.

Mode A ON-Delay

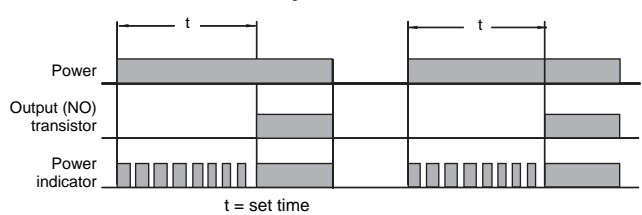

Mode E Interval

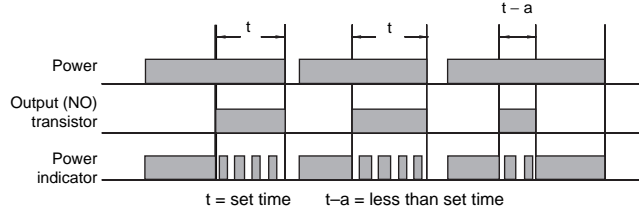

■ H3CR-A8EL/A8E TWO-FUNCTION TIMER, SPDT CONTACT, INSTANTANEOUS OUTPUT

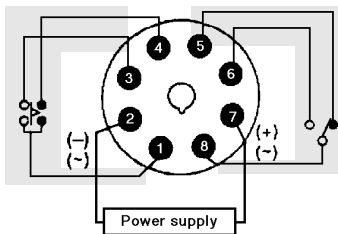

Mode A ON-Delay

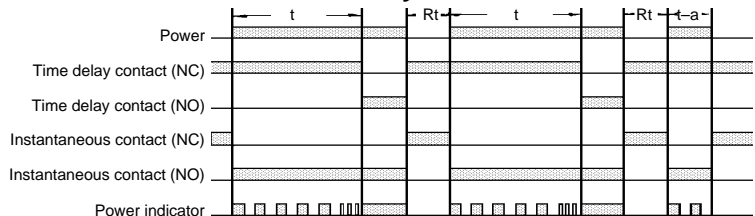

Mode E Interval

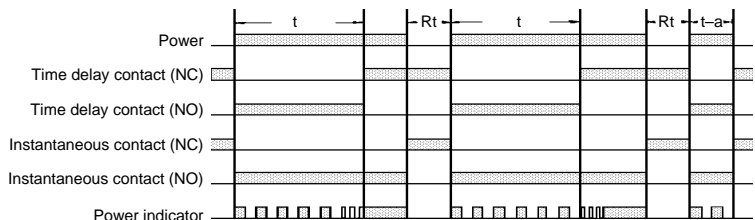

t = set time t-a = less than set time Rt = reset time

Dimensions

Unit: mm (inch)

■ TIMERS

H3CR-A, H3CR-AS, H3CR-A8, H3CR-A8S,
H3CR-A8E

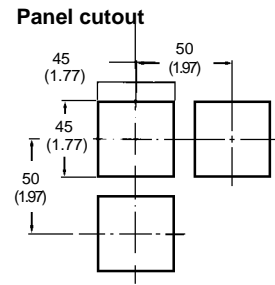
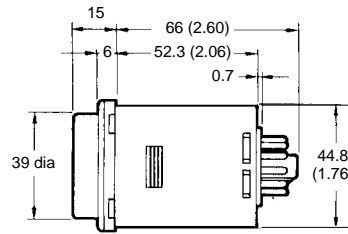
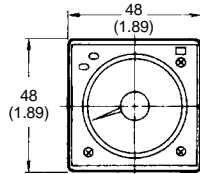
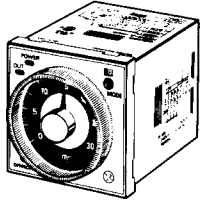

Note: Recommended panel thickness is 1 to 3.2 mm.

Panel cutout conforms to DIN 43700.

H3CR-A8EL

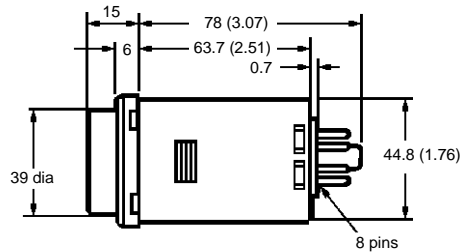
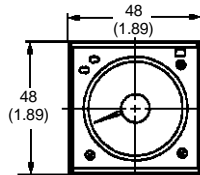
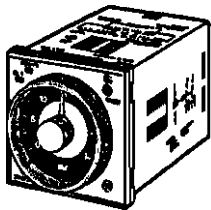

Timer with Y92P Panel Cover and Y92S Setting Ring

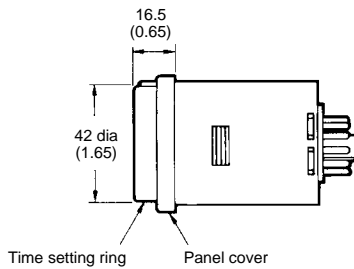
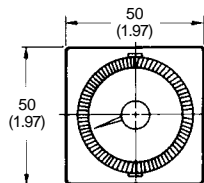
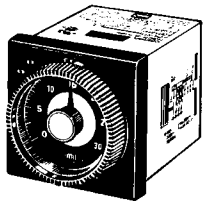

Overall Mounting Depth

Track Mounting P2CF-11

Track Mounting P2CF-08

Panel Mounting P3GA-11

Panel Mounting P3G-08

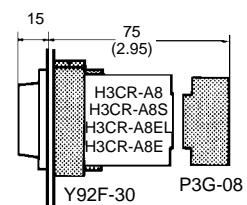
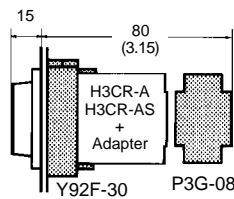
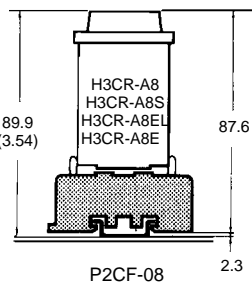
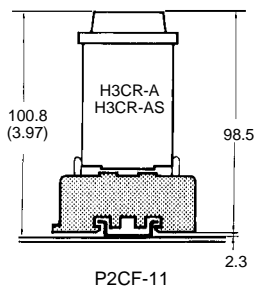

■ SOCKETS

11-Pin Sockets for H3CR-A, H3CR-AS

P2CF-11 Bottom surface or track mounting socket

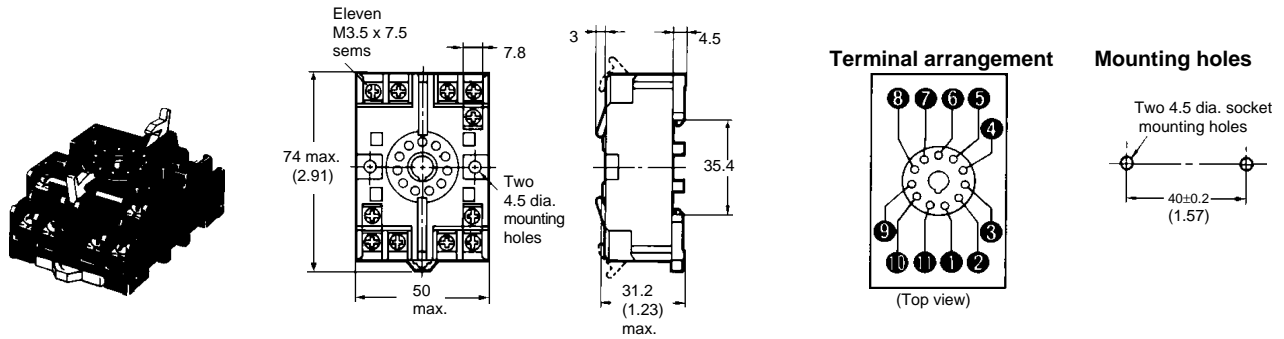

P3GA-11 Back Mounting Socket

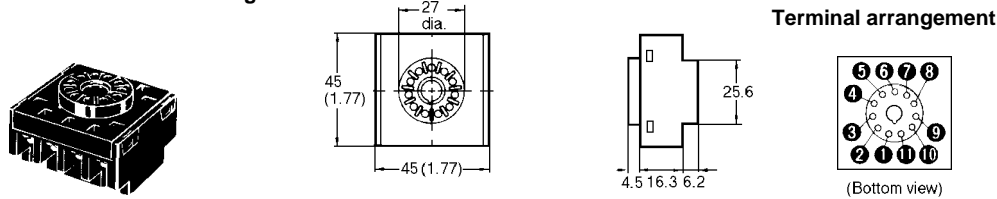

8-Pin Sockets for H3CR-A8, H3CR-A8S, H3CR-A8E, H3CR-A8EL

P2CF-08 Bottom surface or track mounting

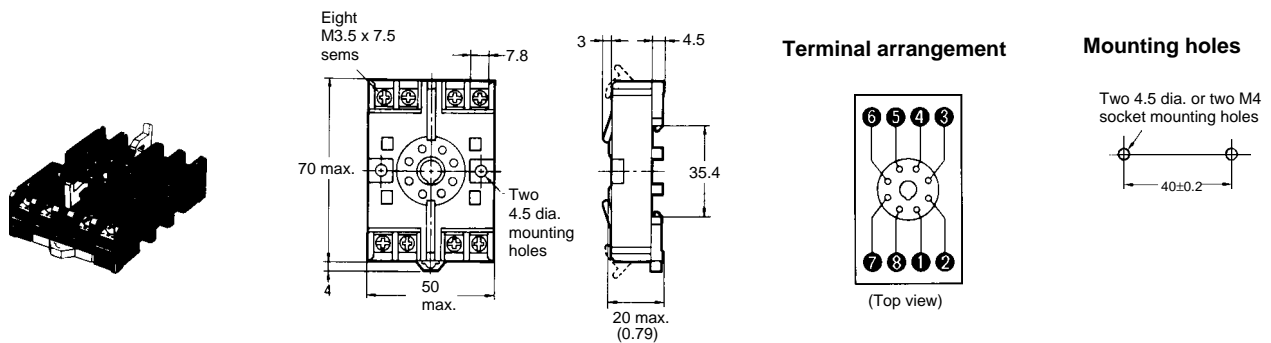

P3G-08 Back mounting socket

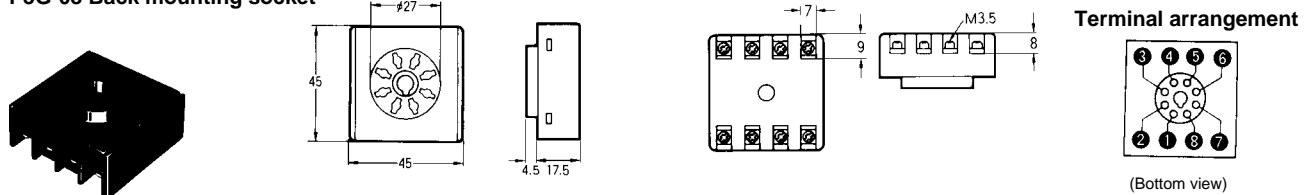

■ PANEL MOUNTING ADAPTERS

Y92F-30 Flush Mounting Adapter

Adapter installs behind the panel. It is ideal for side by side installation. Use P3GA-11 or P3G-08 sockets.

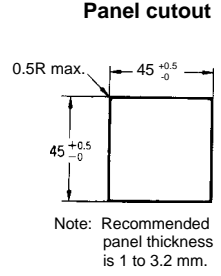
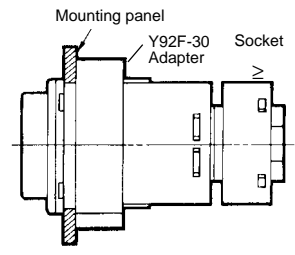
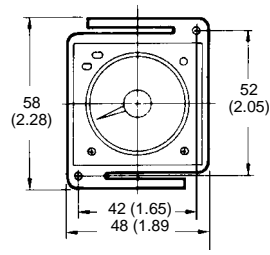
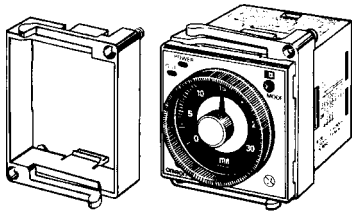

Y92F-73/70 Flush Mounting Adapter

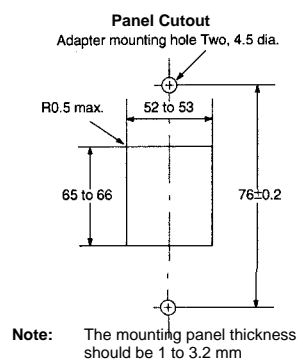
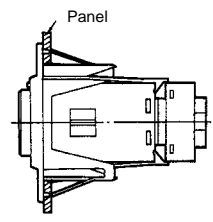
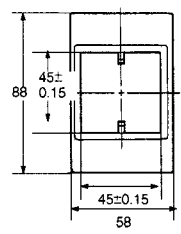
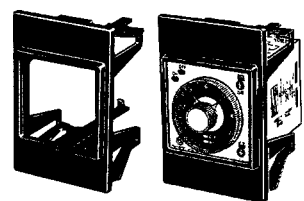

Y92F-74/71 Flush Mounting Adapter

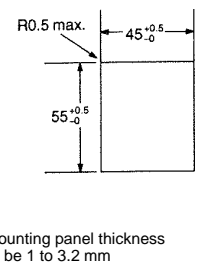
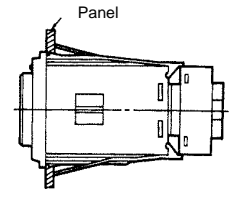
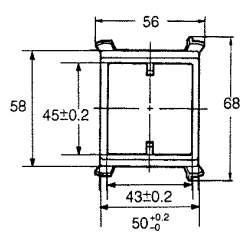
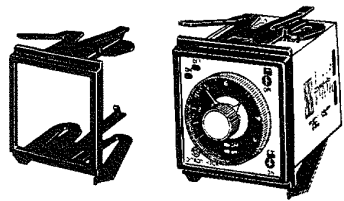

Models Y92F-73 and Y92F-74 can be used with product whose body length is 66 mm.
 Models Y92F-70 and Y92F-71 can be used with product whose body length is 78 mm.

■ PROTECTIVE COVER

Y92A-48B

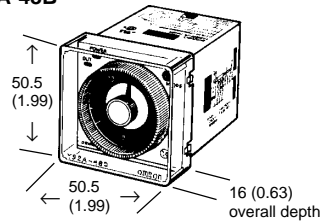

The hard plastic protective cover prevents accidental resetting. It also shields the front panel from dirt and water. The cover is intended for use in areas where unusual service conditions do not exist. The Y92A-48B cover cannot be used with the Y92P Panel Covers below.

■ PANEL COVERS

Omron offers three colors of panel covers to match panel design aesthetics. Choose light gray (Munsell 5Y7/1) to match the case, medium gray (Munsell 5Y5/1) or black (Munsell N1.5). Panel covers conceal the time range and timing function selector knobs. The time setting rings can be used with panel covers.

Y92P-48GL
Light Gray

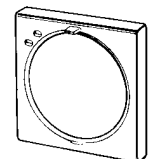

Y92P-48GM
Medium Gray

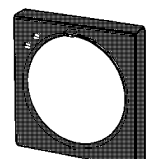

Y92P-48GB
Black

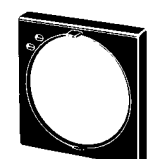

TIME SETTING RINGS

Time setting rings allow the operator to lock in a selected, preset time. They must be used with Y92P Panel Covers. Each ring fits snugly around the time setting knob. A notch on the ring engages the tab on the panel cover to prevent setting

knob travel. Omron offers two types of time setting rings in medium gray. The Y92S-27 setting ring is used for a single set point. The Y92S-28 pair of rings are used to lock in two set points for a timing range.

Y92S-27 Setting a Single Preset

In this example, the time setting will be locked at 10 minutes:
 Select timing function and set unit of measure to "min". Install the panel cover. Turn the time setting knob to 10. Align the notch on the ring with the tab then press the ring onto the time setting knob.

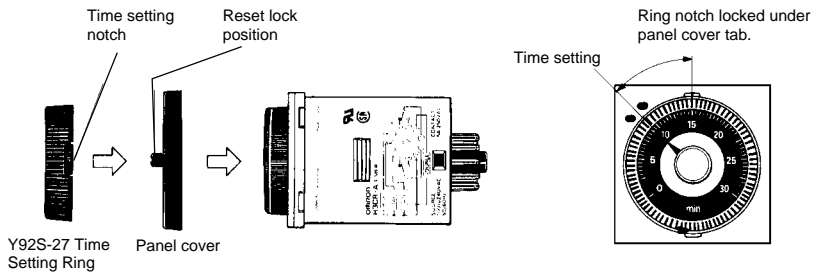

Y92S-28 Limiting the Setting Range

In this example, the timing range of 10 to 20 minutes will be locked in using the two rings in Y92S-28:
 Set the timing function and set unit of measure to "min". Turn the setting knob right to 10. Align the thinner ring's tab with the right side of the panel cover tab. Press the ring onto the time setting knob to set the lower limit. Turn the time setting knob to 20. Align the thicker ring's tab with the left side of the panel cover tab. Press the ring onto the time setting knob to set the upper limit.

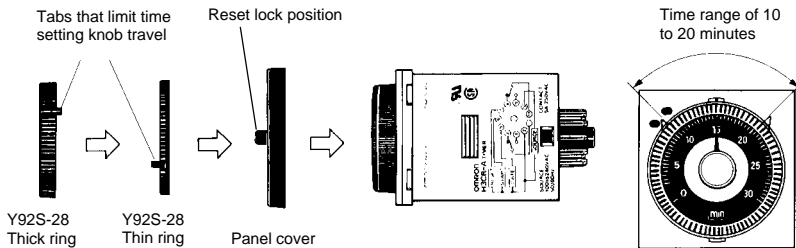

MOUNTING TRACK AND ACCESSORIES

PPF-100N/PPF-50N DIN Rail

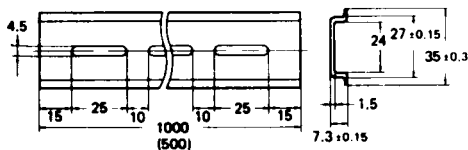

PPF-M End Plate

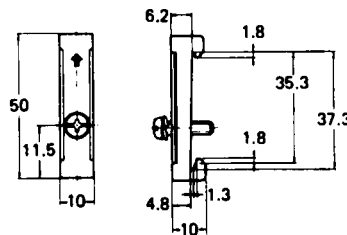

PPF-S Spacer

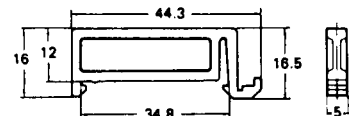

Connections

INPUT/OUTPUT FUNCTIONS

Name	Type	Description
Start input	No-voltage contact closure	Initiates timing.
Reset input	No-voltage contact closure	Interrupts time measurement and reset the operation to start. No time measurement is made and the control output is OFF while the reset input is ON.
Gate input	No-voltage contact closure	Inhibits time measurement. Timing resumes when the gate input is turned OFF.
Control output	Relay or transistor	Turns ON and OFF when the preset value is reached, according to the operation mode selected.

CONNECTION SUMMARY

Part number	Input terminal number (no-voltage only)			Power supply terminal numbers		Output terminal numbers			
	Gate	Start	Reset	AC (common), DC-	AC (hot), DC+	Type	COM	NC	NO
H3CR-A	5	6	7	2	10	Timed contact	1	4	3
H3CR-AS	5	6	7	2	10	Timed contact	11	8	9
H3CR-A8	—	—	—	2	7	Transistor (NPN/PNP)	11	—	9
H3CR-A8	—	—	—	2	7	Timed contact	1	4	3
H3CR-A8S	—	—	—	2	7	Timed contact	8	5	6
H3CR-A8S	—	—	—	2	7	Transistor (NPN/PNP)	8	—	6
H3CR-A8EL	—	—	—	2	7	Timed contact	1	4	3
H3CR-A8E	—	—	—	2	7	Instantaneous contact	8	5	6

CONTACT SIGNAL INPUTS

Input Signal Requirements

Resistance	1 kΩ max.
Residual voltage	1 V max. when the contact makes
Contact type	Capable of switching 80 μA at 5 VDC

H3CR-A

- Start input contact between terminals 2 and 6.
- Reset input contact between terminals 2 and 7.
- Gate input contact between terminals 2 and 5.

H3CR-A

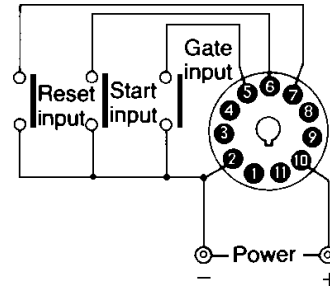

SOLID-STATE SIGNAL INPUTS

Input Signal Requirements

Input type	Open collector transistor
Voltage when collector is OFF	20 V min.
Saturated voltage when transistor is ON	1 V max.
Collector current	50 mA min.
Input current between collector and base	0.5 μA max.
Resistance when transistor is ON	1 kΩ max.
Residual voltage when transistor is ON	2 V max.
Resistance when transistor is OFF	200 kΩ min.

Solid-State Inputs (NPN or PNP with voltage)

Proximity and photoelectric sensors often have NPN or PNP type solid-state output circuits and rated supply voltages ranging from 6 to 30 VDC. A typical NPN connection is shown below.

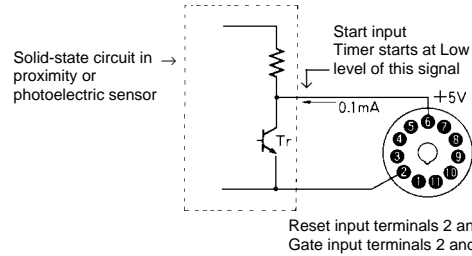

H3CR-AS

Solid-state input signal terminal connections are the same as those for contact signal inputs.

Installation

WIRING PRECAUTIONS (H3CR-A)

Except for the wiring of the power supply circuit, avoid laying input signal wires in parallel or in the same conduit with high tension or power lines. Use shielded wires or wiring with independent metal conduits for the shortest possible distance.

Never touch the input terminals while power is being applied to the timer to prevent electric shock.

An AC power supply can be connected to the power input terminals without regard to polarity. A DC power supply must be connected to the power input terminals as designated according to the polarity of the terminals.

A DC power supply can be connected if its ripple factor is 20% or less and the mean voltage is within the rated operating voltage of the timer.

Connect the power supply voltage through a relay or switch in such a way that the voltage reaches a fixed value at once, otherwise the timer may not reset or a timing error could result.

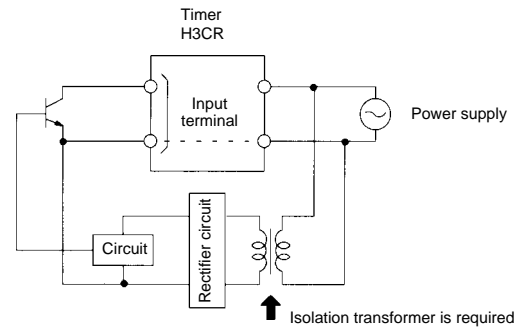

Use an isolation transformer for the power supply of an input device. The transformer's primary and secondary windings should be mutually isolated and the secondary winding not grounded.

WIRING TRANSISTOR OUTPUTS (H3CR-AS, H3CR-A8S)

The optoisolated output from the transistor allows both NPN and PNP input devices to be connected to the H3CR's output. Connect the load to the transistor output (terminals 9 and 11) according to the NPN or PNP input requirements of the device.

For NPN Input Devices

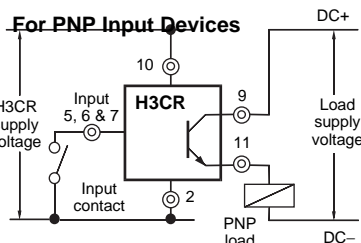
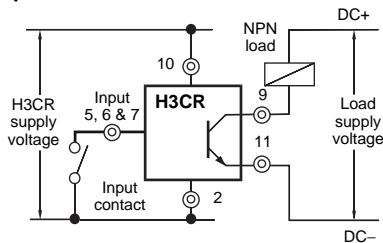

■ SETTING CHANGES DURING OPERATION

Do not change the time unit, time range or operation mode while the timer is in operation. This will cause a malfunction.

■ CONNECTIONS

Parallel Connections

When timers are connected in parallel, be sure to connect the same number terminals to each other.

Proper Input Connections

The neutral or common of the power supply is connected to terminal 2 of the timer. This terminal is also used as the common for the input signals. Terminal 10 should be connected to the "hot" or positive of the power supply. **Do not** use terminal 10 as the common terminal or the timer will be damaged.

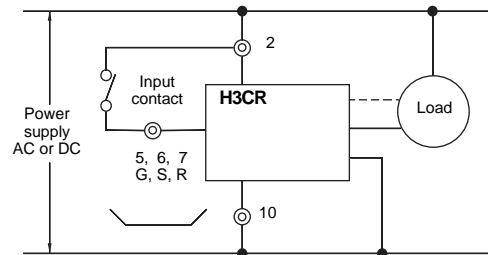

Proper Output Connections

Design your control circuit using the output relay contacts to switch the load. **Never switch a load with the contact that is being used as an input signal.** The timer's circuitry may be damaged. More importantly, it is unsafe electrical practice to control a load by switching the common or neutral.

Operation

■ SELECTING TIME RANGES

The time unit is selected by turning the rotary switch located on the front panel in the lower right corner. Choose seconds, minutes, hours or 10 hours. The time range is selected by turning the rotary switch in the lower left corner. Dial digits appear in the windows around the time setting knob. The table below shows dial digits that appear in the windows for each time range. Use a small flat-blade or Phillips screwdriver.

Time range	Time units			
	sec(onds)	min(utes)	hrs (hours)	10h (10 hours)
1.2	0.05 to 1.2	0.12 to 1.2	0.12 to 1.2	1.2 to 12
3	0.3 to 3	0.3 to 3	0.3 to 3	3 to 30
12	1.2 to 12	1.2 to 12	1.2 to 12	12 to 120
30	3 to 30	3 to 30	3 to 30	30 to 300
0	Instantaneous output*			

* Set the time setting knob to below zero. Use the instantaneous output to check sequential operation of input and output devices attached to the timer.

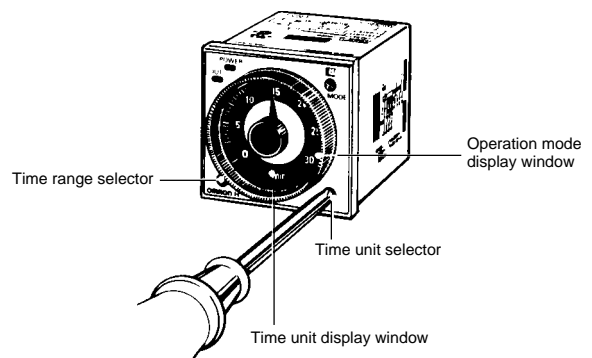

SELECTING OPERATION MODES

The operation mode of H3CR timers is selected by turning the rotary switch in the top right corner of the front panel. Select the mode using a small flat-blade or Phillips screwdriver. Note that H3CR-A8, H3CR-A8S, H3CR-A8E and H3CR-A8EL only have Mode A (ON-delay) and Mode E (Interval).

Mode	Function
A	ON-delay
B	Repeat cycle/signal OFF start
B2	Repeat cycle/signal ON start
C	Signal ON/OFF-delay
D	Signal OFF-delay
E	Interval

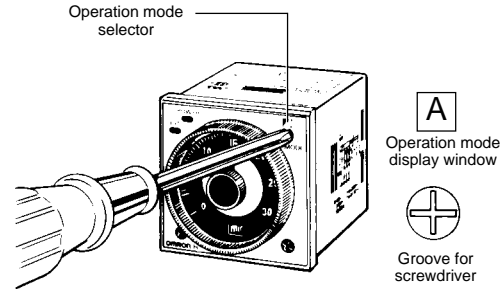

CAUTIONS

Do not change the time unit or time range while the timer is in operation. Otherwise, the timer may malfunction or be damaged. Be sure to turn off the power supply to the timer before changing any of the selections.

Mounting

PANEL MOUNTING

Using Y92F-30 Adapter

Insert the timer through the panel cutout. Push the Y92F-30 adapter from the rear of the timer as far forward toward the panel as possible. Wire the P3G□□ socket, then push it onto the rear of the timer. Then tighten the two retaining screws. To release the adapter, lift the tab at the rear of the adapter.

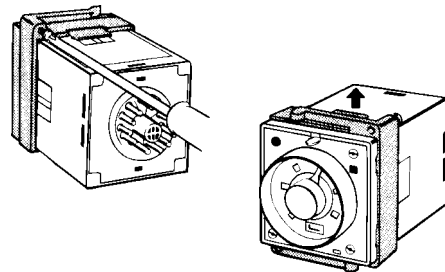

Several timers may be panel mounted close together using Y92F-30 adapter as shown here. When mounting two or more timers in a vertical line, arrange the adapters so that their molded tabs are positioned on the right and left sides. When mounting two or more timers in a horizontal line, arrange the adapters so that their molded tabs are positioned on the top and bottom sides.

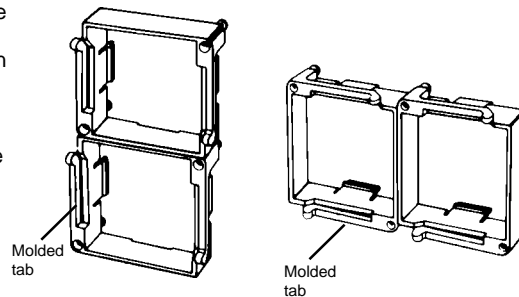

Panel cutout for side-by-side mounting of two timers

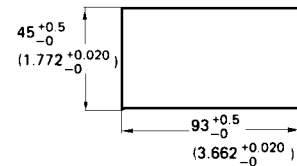

TRACK MOUNTING

Using P2CF-□□ Socket

Mounting

The P2CF-□□ socket has two hooks that secure the timer to the socket. Be sure to allow at least 20 mm (0.79 in) clearance above and below the socket to gain access and to release the hooks for servicing and maintenance. Insert timer into the socket. Latch hooks. Then clip rear of the socket to the track. Push the bottom onto the track until the latch hooks securely.

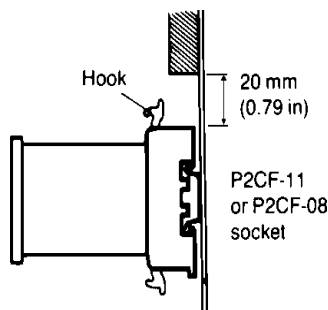

Removal

Pull the latch on the socket with a flat-blade screwdriver and remove the timer and socket as one unit.

NOTE: DIMENSIONS ARE IN MILLIMETERS. To convert millimeters to inches, divide by 25.4

OMRON

OMRON ELECTRONICS, INC.

One East Commerce Drive
Schaumburg, IL 60173

1-800-55-OMRON

OMRON CANADA, INC.

885 Milner Avenue
Scarborough, Ontario M1B 5V8

416-286-6465

X-ON Electronics

Largest Supplier of Electrical and Electronic Components

Click to view similar products for [Relay Sockets & Fixings](#) category:

Click to view products by [Omron](#) manufacturer:

Other Similar products are found below :

[00008258500](#) [00111976502](#) [0000-825-81-00](#) [60SY4S05](#) [M41G](#) [670-0125](#) [670-0127](#) [6700152](#) [670-0153](#) [6700156](#) [D258-2TS00](#) [70-309](#) [7-1393143-3](#) [7-1616360-5](#) [8000-DG2-5](#) [911361](#) [9-1616339-5](#) [PJF11N](#) [GDA12HA](#) [GDA12HD](#) [GDA12SA](#) [GDA12SD](#) [GDA16HD](#) [GDA22HA](#) [GDA95A](#) [GDA95D](#) [GFX20](#) [PT08QN](#) [PT 1/8 D = 3.2](#) [GUA1](#) [GUA2-11](#) [GUA4-04](#) [GUA4-31](#) [GUM5R](#) [GUR-120](#) [GUR-24](#) [GUR-240](#) [GUR-277](#) [GURX-277](#) [GUW12](#) [GUW95](#) [GUZ63L](#) [R99-11 FOR MY\(NAMEPLATE\)](#) [D52PR2T](#) [RES100K](#) [1310H-HDC](#) [1390H-1ST](#) [1393824-3](#) [1390H-2PC](#) [1410-2SM](#)