

# Relays with Forcibly Guided Contacts G7SA

## Compact, Slim Relays Conforming to EN Standards

- Additional Push-In Plus terminal sockets are used to save wiring work in comparison with traditional screw terminals. (Wiring time is reduced by 60%\* in comparison with traditional screw terminals.)
  - Relays with forcibly guided contacts (EN 50205 Class A, certified by VDE).
  - Supports the CE marking of machinery (Machinery Directive).
  - Helps avoid hazardous machine status when used as part of an interlocking circuit.
  - Four-pole and six-pole Relays are available.
  - The Relay's terminal arrangement simplifies PWB pattern design.
  - Reinforced insulation between inputs and outputs.  
Reinforced insulation between some poles of different polarity.
- \* According to OMRON actual measurement data

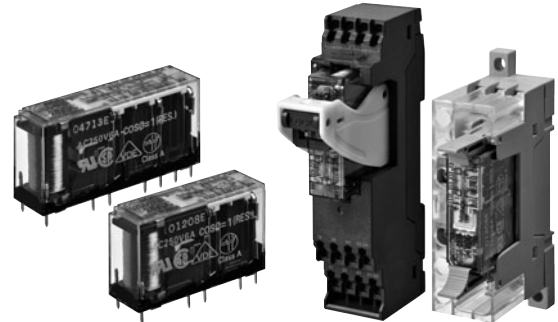

**Note:** Sockets are sold separately.

For the most recent information on models that have been certified for safety standards, refer to your OMRON website.

Be sure to read the *Safety Precautions* on page 9.

## Model Number Structure

### Model Number Legend

Specify the power supply voltage (coil rated voltage) when ordering.

#### Relays with forcibly guided contacts

G7SA-  A  B  

1    2    3

- 1. NO Contact Poles**    **2. NC Contact Poles**
- 2: DPST-NO                    1: SPST-NC  
3: 3PST-NO                    2: DPST-NC  
4: 4PST-NO                    3: 3PST-NC  
5: 5PST-NO

#### 3. Coil Rated Voltage (V)

12 VDC  
18 VDC  
21 VDC  
24 VDC  
48 VDC  
110 VDC

#### Sockets

P7SA-  -  -  -  

1    2 3    4    5 6

- 1. Basic Model Name**  
P7SA: Socket for G7SA
- 2. Number of Poles**  
10: 4 poles (10 terminals)  
14: 6 poles (14 terminals)
- 3. Mounting Type**  
F: Front-mounting  
P: Back-mounting

#### 4. LED Indicator

Blank: Without operation indicator LED/built-in diode  
ND: With operation indicator LED/built-in diode

#### 5. Terminal Type

Blank: Screw terminals when 3. is F type  
PCB terminals when 3. is P type  
PU: Push-In Plus terminals

#### 6. Coil Rated Voltage (V)

24 VDC: When 4. is ND

# G7SA

## Ordering Information

Specify the coil rated voltage when ordering.

### Relays with Forcibly Guided Contacts

Type	Sealing	Poles	Contact configuration	Coil rated voltage	Model
Standard	Flux-tight	4 poles	3PST-NO, SPST-NC	12, 18, 21, 24, 48, 110 VDC	<b>G7SA-3A1B</b>
			DPST-NO, DPST-NC	12, 18, 21, 24, 48, 110 VDC	<b>G7SA-2A2B</b>
		6 poles	5PST-NO, SPST-NC	12, 18, 21, 24, 48, 110 VDC	<b>G7SA-5A1B</b>
			4PST-NO, DPST-NC	12, 18, 21, 24, 48, 110 VDC	<b>G7SA-4A2B</b>
			3PST-NO, 3PST-NC	12, 18, 21, 24, 48, 110 VDC	<b>G7SA-3A3B</b>

### Sockets

Mounting	Terminal Type	LED Indicator	Poles	Coil rated voltage	Model	
Front-mounting	Push-In Plus terminals	Yes	4 poles	24 VDC	<b>P7SA-10F-ND-PU</b>	
			6 poles		<b>P7SA-14F-ND-PU</b>	
	Screw terminals	Yes	4 poles		<b>P7SA-10F-ND</b>	
			6 poles		<b>P7SA-14F-ND</b>	
		No	4 poles		—	<b>P7SA-10F</b>
			6 poles			<b>P7SA-14F</b>
Back-mounting	PCB terminals	No	4 poles	—	<b>P7SA-10P</b>	
			6 poles		<b>P7SA-14P</b>	

### Accessories (Order Separately)

#### Short Bars (For P7SA-□F-ND-PU)

Pitch	No. of poles	Colors	Model*1*2
5.2 mm	2	Red (RD) Blue (BL) Yellow (YL)	<b>XW5S-P2.5-2□</b>
	3		<b>XW5S-P2.5-3□</b>
	4		<b>XW5S-P2.5-4□</b>
	5		<b>XW5S-P2.5-5□</b>

**Note:** Use for crossover wiring of adjacent contact terminals (bottom) within one Socket.

\*1. Replace the box (□) in the model number with the code for the covering color. Color Options: RD = red, BL = blue, YL = yellow

Example: XW5S-P2.5-10RD when the covering color is red.

\*2. XW5S-P2.5-5□ cannot be used with P7SA-10F-ND-PU.

#### Parts for DIN Track Mounting

Type	Model	Minimum Order (quantity)
DIN Tracks	1 m	1
	0.5 m	
End Plate *	<b>PFP-M</b>	10
Spacer	<b>PFP-S</b>	

Refer to your OMRON website for details on the PFP-□.

\* When mounting DIN track, please use End Plate (Model PFP-M).

## Specifications

### Ratings

#### Coil (4 poles)

Item	Rated current (mA)	Coil resistance (Ω)	Max. voltage (V)	Power consumption (mW)
Rated voltage				
12 VDC	30	400	110%	Approx. 360
18 VDC	20	900		
21 VDC	17.1	1,225		
24 VDC	15	1,600		
48 VDC	7.5	6,400		
110 VDC	3.8	28,810		

#### Coil (6 poles)

Item	Rated current (mA)	Coil resistance (Ω)	Max. voltage (V)	Power consumption (mW)
Rated voltage				
12 VDC	41.7	288	110%	Approx. 500
18 VDC	27.8	648		
21 VDC	23.8	882		
24 VDC	20.8	1,152		
48 VDC	10.4	4,606		
110 VDC	5.3	20,862		

- Note:** 1. The rated current and coil resistance are measured at a coil temperature of 23°C with tolerances of ±15%.  
 2. The maximum voltage is based on an ambient operating temperature of 23°C maximum.

### Characteristics

Contact resistance *1	100 mΩ max.	
Operating time *2	20 ms max.	
Response time *3	10 ms max.	
Release time *2	20 ms max.	
Must operate voltage	75% max.	
Must release voltage	10% min.	
Maximum operating frequency	Mechanical	36,000 operations/h
	Rated load	1,800 operations/h
Insulation resistance *4	1,000 MΩ min.	
Dielectric Strength *5 *6	Between coil and contacts	4,000 VAC, 50/60 Hz for 1 min.
	Between contacts of different polarity	4,000 VAC, 50/60 Hz for 1 min. (except for followings) 4 poles (for poles 3-4 in 4-pole Relays), 6 poles (for poles 3-5, 4-6, and 5-6 in 6-pole Relays): 2,500 VAC, 50/60 Hz for 1 min.
	Between contacts of the same polarity	1,500 VAC, 50/60 Hz for 1 min.
Vibration resistance	10 to 55 to 10 Hz, 0.75-mm single amplitude (1.5-mm double amplitude)	
Shock resistance	Destruction	1,000 m/s <sup>2</sup>
	Malfunction	100 m/s <sup>2</sup>
Durability *7	Mechanical	10,000,000 operations min. (at approx. 36,000 operations/h)
	Electrical	100,000 operations min. (at the rated load and approx. 1,800 operations/h)
Inductive load switching capability *8 (IEC60947-5-1)	AC15 AC240V 2A DC13 DC24V 1A	
Failure rate (P level) (reference value *9)	5 VDC, 1 mA	
Ambient operating temperature *10	12 to 48 VDC: -40 to 85°C (with no icing or condensation) 110 VDC: -40 to 60°C (with no icing or condensation)	
Ambient operating humidity	5% to 85% RH	
Weight	4 poles: Approx. 22 g 6 poles: Approx. 25 g	

**Note:** 1. The above values are initial values.

2. Performance characteristics are based on coil temperature of 23°C.

\*1. The contact resistance was measured with 1 A at 5 VDC using the voltage-drop method.

\*2. These times were measured at the rated voltage and an ambient temperature of 23°C. Contact bounce time is not included.

\*3. The response time is the time it takes for the normally open contacts to open after the coil voltage is turned OFF. Contact bounce time is included. Measurement conditions: Rated voltage operation, Ambient temperature: 23°C

\*4. The insulation resistance was measured with a 500-VDC megohmmeter at the same locations as the dielectric strength was measured.

\*5. Pole 3 refers to terminals 31-32 or 33-34, pole 4 refers to terminals 43-44, pole 5 refers to terminals 53-54, and pole 6 refers to terminals 63-64.

\*6. When using a P7SA Socket, the dielectric strength between coil contacts/different poles is 2,500 VAC, 50/60 Hz for 1 min. When using Push-In Plus terminal sockets (P7SA-□F-ND-PU), the dielectric strength between coil contacts as well as between different poles is 4,000 VAC, 50/60 Hz for 1 min.

\*7. The durability is for an ambient temperature of 15 to 35°C and an ambient humidity of 25% to 75%. For the durability performance to the load, refer to the Durability Curve.

\*8. AC15:  $\cos\phi = 0.3$ , DC13: L/R = 48-ms.

\*9. The failure rate is based on an operating frequency of 300 operations/min.

\*10. 12 to 48 VDC: When operating between 70 and 85°C, reduce the rated carry current of 6 A by 0.1 A for each degree above 70°C.  
110 VDC: When operating between 40 and 60°C, reduce the rated carry current of 6 A by 0.27 A for each degree above 40°C.

#### Contacts

Item	Load	Resistive load
Rated load		6 A at 250 VAC, 6 A at 30 VDC
Rated carry current		6 A
Max. switching voltage		250 VAC, 125 VDC
Max. switching current		6 A
Contact materials		Au plating + Ag alloy

## Characteristics of Sockets

Items	Models	Push-In Plus terminals		Screw terminals		PCB terminals	
		4 poles	6 poles	4 poles	6 poles	4 poles	6 poles
		P7SA-10F-ND-PU	P7SA-14F-ND-PU	P7SA-10F(-ND)	P7SA-14F(-ND)	P7SA-10P	P7SA-14P
Ambient operating temperature		<ul style="list-style-type: none"> <li>With operation indicator LED/built-in diode P7SA-□F-ND(-PU): -20 to +70°C</li> <li>Without operation indicator LED/built-in diode P7SA-□F: -40 to +85°C (with no icing or condensation)</li> </ul>				-40 to +85°C (with no icing or condensation)	
Ambient operating humidity		25 to 85% RH				5 to 85% RH	
Continuous carry current		6 A *1					
Dielectric strength	Between coil and contact terminals	4,000 VAC for 1 min.		2,500 VAC for 1 min.			
	Between contact terminals of different polarity	2,500 VAC for 1 min.					
	Between contact terminals of same polarity	1,500 VAC for 1 min.					
Insulation resistance		1,000 MΩ min. *2					
Weight		Approx. 58 g	Approx. 70 g	Approx. 44 g	Approx. 59 g	Approx. 9 g	Approx. 10 g

- \*1. When operating the P7SA-□F-ND-PU at a temperature between 50 and 70°C, reduce the continuous current (6 A at 50°C or less) by 0.25 A for each degree above 50°C.  
 When operating the P7SA-□F-ND at a temperature between 50 and 70°C, reduce the continuous current (6 A at 50°C or less) by 0.3 A for each degree above 50°C.  
 When operating the P7SA-□F at a temperature between 50 and 85°C, reduce the continuous current (6 A at 50°C or less) by 0.1 A for each degree above 50°C.
- \*2. Measurement conditions: For 500 VDC applied to the same location as for dielectric strength measurement.

## Engineering Data

### Durability Curve

#### G7SA-□A□B

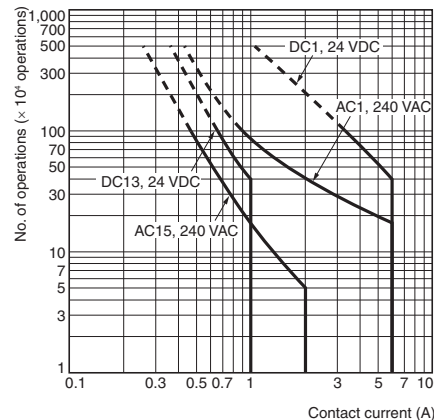

### Ambient temperature and contact current

#### P7SA-□F-ND-PU

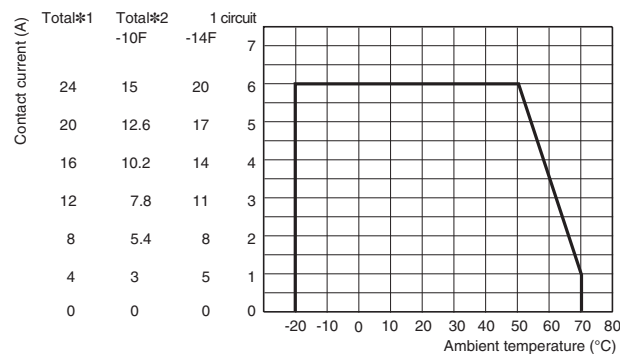

#### P7SA-□F-ND

#### P7SA-□F

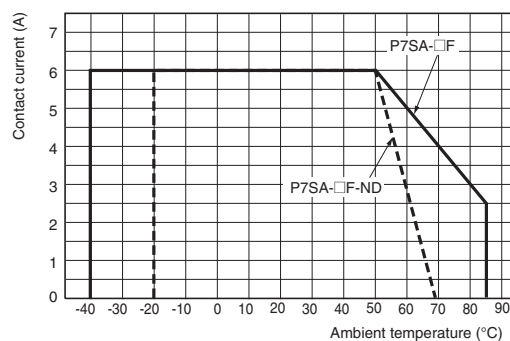

- \*1. When using a G7SA-5A1B relay, be careful not to exceed the total current (24 A).  
 (Example: at 50°C, 5 contacts × 4.8 A)

- \*2. Certification conditions for the TÜV certification. Care should be taken not to exceed the total current.

Dimensions

Relays with Forcibly Guided Contacts

4 poles  
G7SA-3A1B  
G7SA-2A2B

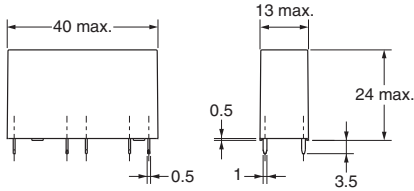
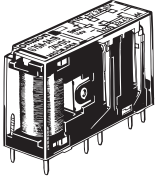

Terminal Arrangement/  
Internal Connection Diagram  
(Bottom View)

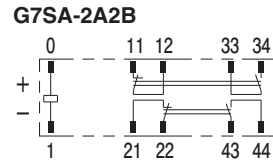
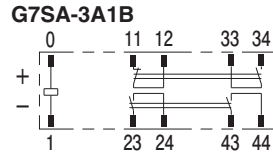

Printed Circuit Board  
Design Diagram  
(Bottom View)  
(±0.1 tolerance)

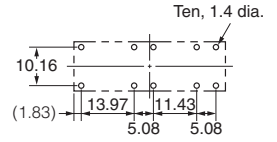

- Note: 1.** Terminals 23-24, 33-34, and 43-44 are normally open. Terminals 11-12 and 21-22 are normally closed.
- 2.** The colors of the cards inside the Relays are as follows: G7SA-3A1B: Blue and G7SA-2A2B: White.

6 poles  
G7SA-5A1B  
G7SA-4A2B  
G7SA-3A3B

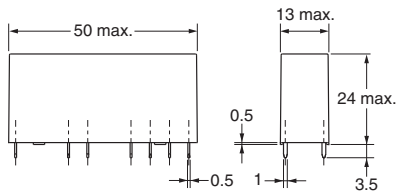
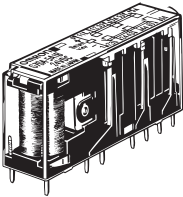

Terminal Arrangement/  
Internal Connection Diagram  
(Bottom View)

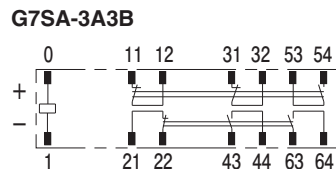
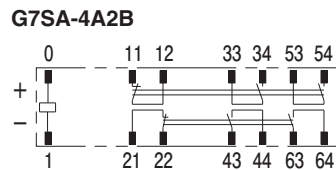
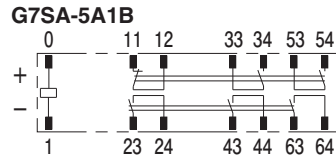

Printed Circuit Board  
Design Diagram  
(Bottom View)  
(±0.1 tolerance)

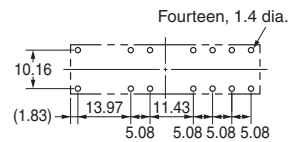

- Note: 1.** Terminals 23-24, 33-34, 43-44, 53-54, and 63-64 are normally open. Terminals 11-12, 21-22, and 31-32 are normally closed.
- 2.** The colors of the cards inside the Relays are as follows: G7SA-5A1B: Blue, G7SA-4A2B: White, and G7SA-3A3B: Yellow.

# G7SA

## Sockets

### Front-mounting Sockets Push-In Plus terminals 4 poles P7SA-10F-ND-PU

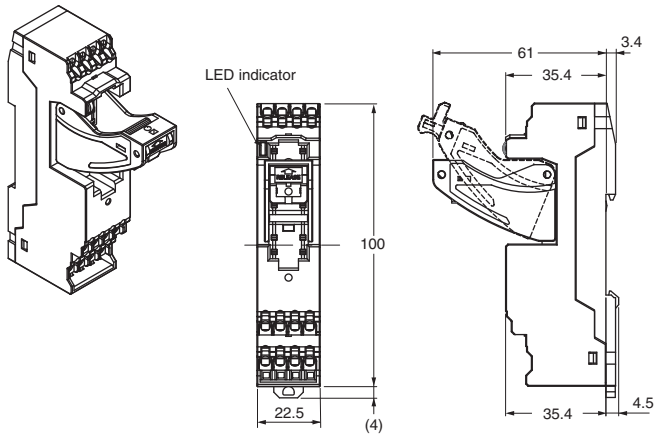

### Terminals Arrangement/Internal Connections Diagram (Top View)

#### G7SA-3A1B Mounted      G7SA-2A2B Mounted

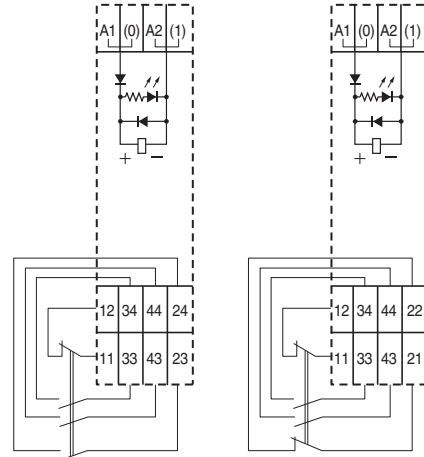

- Note:** 1. The numbers in parentheses are traditionally used terminal numbers.  
2. Terminals 23-24, 33-34, and 43-44 are normally open. Terminals 11-12 and 21-22 are normally closed.

### Push-In Plus terminals 6 poles P7SA-14F-ND-PU

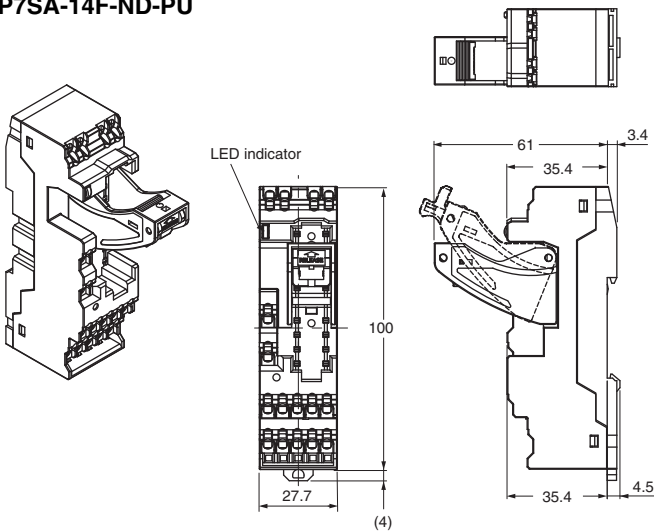

### Terminals Arrangement/Internal Connections Diagram (Top View)

#### G7SA-5A1B Mounted      G7SA-4A2B Mounted      G7SA-3A3B Mounted

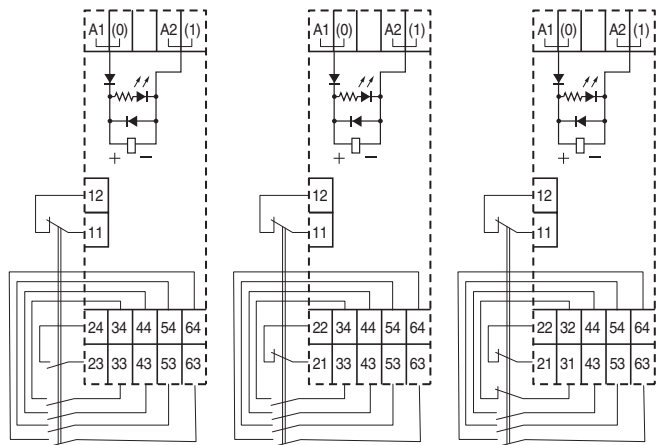

- Note:** 1. The numbers in parentheses are traditionally used terminal numbers.  
2. Terminals 23-24, 33-34, 43-44, 53-54, and 63-64 are normally open. Terminals 11-12, 21-22, and 31-32 are normally closed.

## Accessories (Order Separately)

### Short Bars (for P7SA-□F-ND-PU)

#### XW5S-P2.5-□□

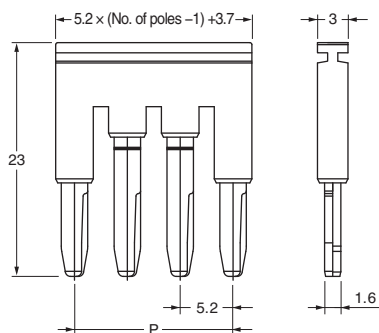

Application	Pitch	Compatible models	No. of poles	P(mm)	Colors	Model *	Maximum carry current
For Contact terminals (bottom)	5.2 mm	For P7SA-□F-ND-PU	2	5.2	Red (RD) Blue (BL) Yellow (YL)	XW5S-P2.5-2□	24 A
			3	10.4		XW5S-P2.5-3□	
			4	15.6		XW5S-P2.5-4□	
			5	20.8		XW5S-P2.5-5□	

**Note:** Use for crossover wiring of adjacent contact terminals (bottom) within one Socket.  
\* Replace the box (□) in the model number with the code for the covering color.  
Color Options: RD = red, BL = blue, YL = yellow

**Front-mounting Sockets**  
**Screw terminals 4 poles**  
**P7SA-10F, P7SA-10F-ND**

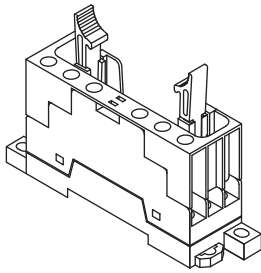

The above figure shows with the finger cover mounted.

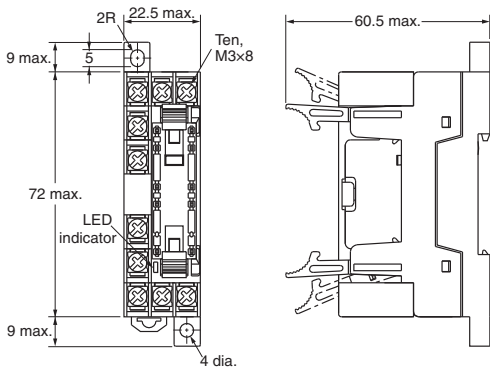

**Note 1:** The front view shows with the finger cover removed.  
**Note 2:** Only the -ND Sockets have LED indicators (orange)

**Terminal Arrangement/Internal Connection Diagram (Top View)**  
**G7SA-3A1B Mounted G7SA-2A2B Mounted**

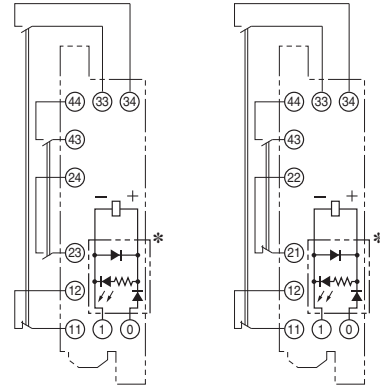

\* This display circuit is available only for "-ND" models.  
**Note:** Terminals 23-24, 33-34, and 43-44 are normally open.  
 Terminals 11-12 and 21-22 are normally closed.

**Mounting Hole Placement Diagram (Top View)**

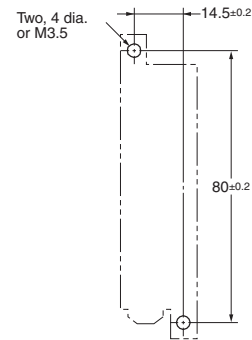

**Screw terminals 6 poles**  
**P7SA-14F, P7SA-14F-ND**

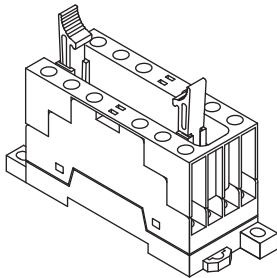

The above figure shows with the finger cover mounted.

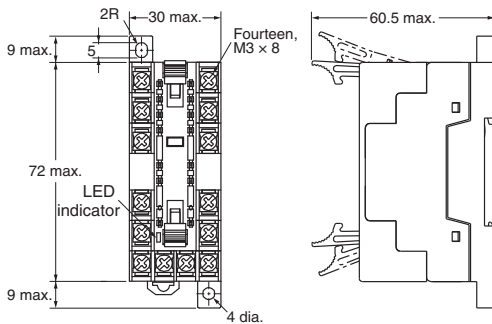

**Note 1:** The front view shows with the finger cover removed.  
**Note 2:** Only the -ND Sockets have LED indicators (orange).

**Terminal Arrangement/Internal Connection Diagram (Top View)**

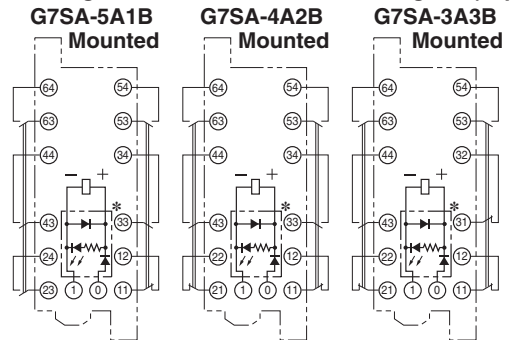

\* This display circuit is available only for "-ND" models.  
**Note:** Terminals 23-24, 33-34, 43-44, 53-54, and 63-64 are normally open. Terminals 11-12, 21-22, and 31-32 are normally closed.

**Mounting Hole Placement Diagram (Top View)**

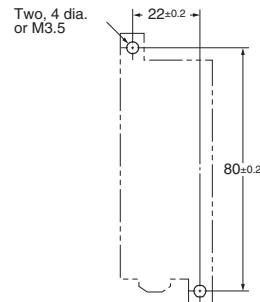

**Accessories (Order Separately)**

**Parts for DIN Track Mounting**

Refer to your OMRON website for details about PFP-□.

# G7SA

## Back-mounting Sockets (for PCB) PCB terminals 4 poles P7SA-10P

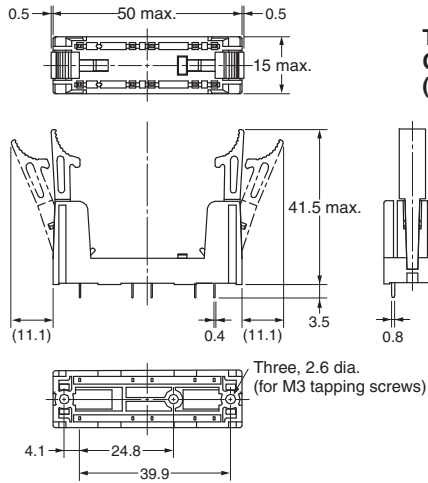
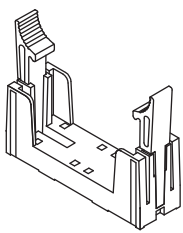

**Terminal Arrangement/Internal Connection Diagram (Bottom View)**

**G7SA-3A1B Mounted**

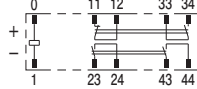

**G7SA-2A2B Mounted**

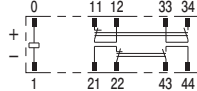

**Mounting Hole Placement (Bottom View)**  
(±0.1 tolerance)

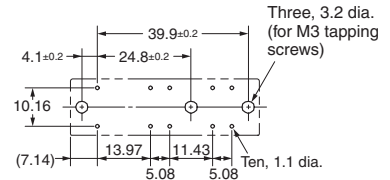

**Note:** Terminals 23-24, 33-34, and 43-44 are normally open. Terminals 11-12 and 21-22 are normally closed.

## PCB terminals 6 poles P7SA-14P

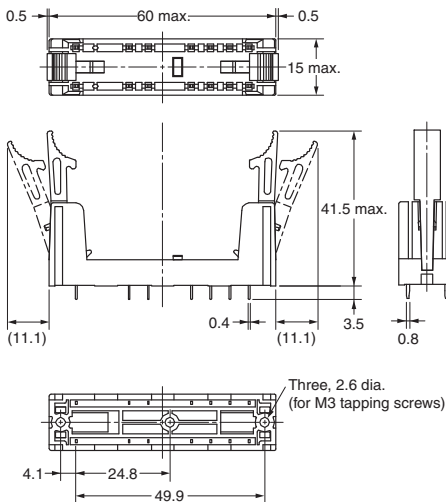
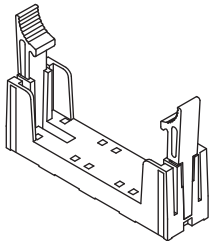

**Terminal Arrangement/Internal Connection Diagram (Bottom View)**

**G7SA-5A1B Mounted**

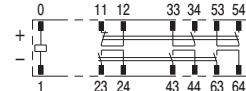

**G7SA-4A2B Mounted**

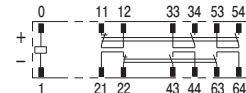

**G7SA-3A3B Mounted**

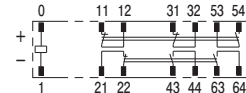

**Mounting Hole Placement (Bottom View)**  
(±0.1 tolerance)

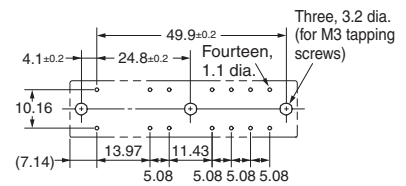

**Note:** Terminals 23-24, 33-34, 43-44, 53-54, and 63-64 are normally open. Terminals 11-12, 21-22, and 31-32 are normally closed.

## Certified Standards

### Relays with forcibly guided contacts

G7SA

- EN Standards, VDE Certified
  - EN 61810-1 (Electromechanical non-specified time all-or-nothing relays)
  - EN 50205 (Relays with forcibly guided (linked) contacts)
- UL standard UL508 Industrial Control Devices
- CSA standard CSA C22.2 No. 14 Industrial Control Devices
- South Korea S-mark certified (Rated voltage 24VDC only)
  - KS C IEC 61810-1
  - EN 50205
- CQC GB/T 21711.1

### Sockets

**Screw terminals / PCB terminals**

P7SA-□F-ND / P7SA-□P

- EN Standards, VDE Certified
  - EN 61984
- UL standard UL508 Industrial Control Devices
- CSA standard CSA C22.2 No. 14 Industrial Control Devices

**Push-In Plus terminals**

P7SA-□F-ND-PU

- EN Standards, TÜV Certified
  - EN 61984
- UL standard UL 508 Industrial Control Devices
- CSA standard CSA C22.2 No.14 Industrial Control Devices

### Forcibly Guided Contacts (from EN 50205)

If an NO contact becomes welded, all NC contacts will maintain a minimum distance of 0.5 mm when the coil is not energized. Likewise if an NC contact becomes welded, all NO contacts will maintain a minimum distance of 0.5 mm when the coil is energized.



## Safety Precautions

Be sure to read the *Common Precautions for All Relays with Forcibly Guided Contacts* at the following URL: <http://www.ia.omron.com/>.

### Warning Indications

<b>Precautions for Safe Use</b>	Supplementary comments on what to do or avoid doing to use the product safely.
<b>Precautions for Correct Use</b>	Supplementary comments on what to do or avoid doing to prevent failure to operate, malfunction, or undesirable effects on product performance.

### Precautions for Safe Use

#### Push-In Plus Terminal Sockets (P7SA-□F-ND-PU)

- Do not attempt to wire anything to the release holes.
- When you insert a flat-blade screwdriver into a release hole, do not tilt or twist the screwdriver. The terminal block may be damaged.
- Insert a screwdriver into the release holes at an angle. The terminal block may be damaged if the screwdriver is inserted straight in.
- Do not allow the flat-blade screwdriver to fall when you are holding it in a release hole.
- Do not bend a wire past its natural bending radius or pull on it with excessive force. Doing so may break the wires.
- Do not insert more than one wire into each terminal insertion hole.
- To prevent wire materials from smoking or igniting, use the wiring materials given in the following table.

Recommended wires	Stripping length	
	Ferrules used	Ferrules not used
0.5 to 1.5 mm <sup>2</sup> / AWG 20 to 16	10 mm	8 mm

- Insert a flat-blade screwdriver all the way to the bottom of the release hole. If the flat-blade screwdriver is not inserted correctly, the wire may not be connected correctly.
- When crossover wiring with wires or short bars, make sure not to insert them in the wrong position. It may cause a short circuit, a malfunction, or a failure.

### Precautions for Correct Use

#### Wiring

- The coil terminals have polarity (+, -). Inverting the polarity when wiring the terminals will cause the unit not to operate.
- The release time and the response time of the G7SA will be longer when using the P7SA-□F-ND(-PU) because it has a built-in diode to absorb coil surge. Because of that, confirm operation under actual conditions before using the P7SA-□F-ND(-PU).

<Using with P7SA-□F-ND-PU Push-In Plus terminal sockets>

- If there is lubrication, such as oil, on the tip of the flat-blade screwdriver, the flat-blade screwdriver may fall and possibly injure a worker.
- Do not insert short bar in the hole for wire or screw driver, it may cause the result of failure of pull out. If insert short bar in the hole for wire or screw driver and try to pull out, it may cause damage for short bar or socket.

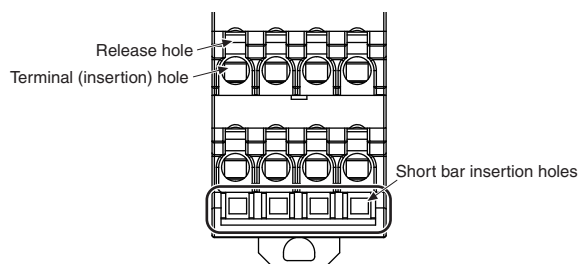

#### Screw Terminal Sockets (P7SA-□F(-ND))

- Use one of the following wires to connect to the P7SA-□F(-ND).
  - Stranded wire: 0.75 to 1.5 mm<sup>2</sup>
  - Solid wire: 1.0 to 1.5 mm<sup>2</sup>
- Tighten the screws of the P7SA-□F(-ND) to a torque of 0.78 to 0.98 N·m. Tighten firmly so as not to have any loose wires.

#### Cleaning

The G7SA is not of enclosed construction. Therefore, do not wash the G7SA with water or detergent.

#### Mounting

The G7SA can be installed in any direction.

#### Mounting and Removing the Relays

<Using with P7SA-□F-ND-PU Push-In Plus terminal sockets>

- After mounting the relay, make sure to lock the lock hook. If not, the relay may become loose upon vibration or impact.
- When removing the relay, (1) unlock the lock hook on the release side, (2) then press the release lever.
- You can release the locked block easily by inserting a tip of a flat screwdriver into the square hole.

#### With the relay mounted

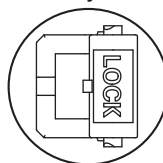

#### Removing the relay

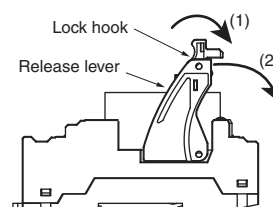
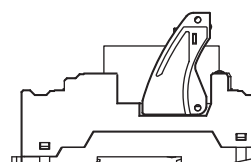
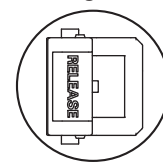

## Push-In Plus Terminal Sockets (P7SA-□F-ND-PU)

### 1. Connecting Wires to the Push-In Plus Terminal Block

#### Part Names of the Terminal Block

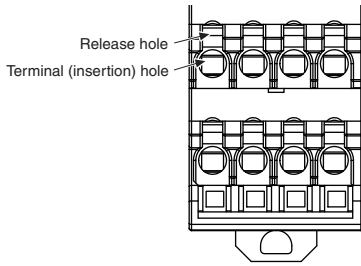

#### Connecting Wires with Ferrules and Solid Wires

Insert the solid wire or ferrule straight into the terminal block until the end strikes the terminal block.

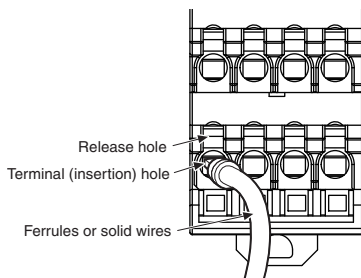

- If a wire is difficult to connect because it is too thin, use a flat-blade screwdriver in the same way as when connecting stranded wire.

#### Connecting Stranded Wires

Use the following procedure to connect the wires to the terminal block.

1. Hold a flat-blade screwdriver at an angle and insert it into the release hole.  
The angle should be between 10° and 15°. If the flat-blade screwdriver is inserted correctly, you will feel the spring in the release hole.
2. With the flat-blade screwdriver still inserted into the release hole, insert the wire into the terminal hole until the end strikes the terminal block.
3. Remove the flat-blade screwdriver from the release hole.

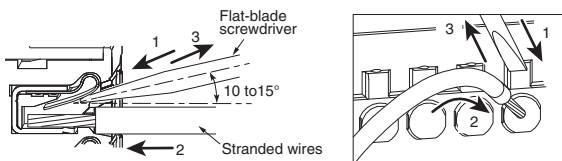

#### Checking Connections

- After the insertion, pull gently on the wire to make sure that it will not come off and the wire is securely fastened to the terminal block.
- To prevent short circuits, insert the stripped part of a stranded or solid wire, or the conductor part of a ferrule until it is hidden inside the terminal insertion hole. (See the following diagram.)

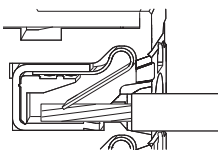

### 2. Removing Wires from the Push-In Plus Terminal Block

Use the following procedure to remove wires from the terminal block. The same method is used to remove stranded wires, solid wires, and ferrules.

1. Hold a flat-blade screwdriver at an angle and insert it into the release hole.
2. With the flat-blade screwdriver still inserted into the release hole, remove the wire from the terminal insertion hole.
3. Remove the flat-blade screwdriver from the release hole.

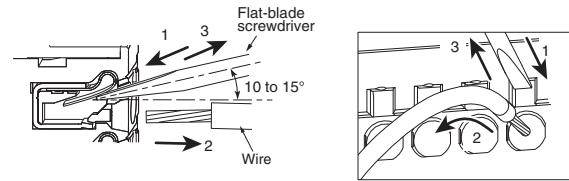

### 3. Recommended Ferrules and Crimp Tools

#### Recommended ferrules

Applicable wire		Ferrule Conductor length (mm)	Recommended ferrules		
(mm <sup>2</sup> )	(AWG)		Phoenix Contact product	Weidmuller product	Wago product
0.5	20	8	AI0.5-8	H0.5/14	FE-0.5-8N-WH
0.75	18	8	AI0.75-8	H0.75/14	FE-0.75-8N-GY
1/1.25	18/17	8	AI1-8	H1.0/14	FE-1.0-8N-RD
1.25/1.5	17/16	8	AI1.5-8	H1.5/14	FE-1.5-8N-BK
Recommended crimp tool			CRIMPFOX6 CRIMPFOX6T-F CRIMPFOX10S	PZ6 roto	Variocrimp4

- Note:**
1. Make sure that the outer diameter of the wire coating is smaller than the inner diameter of the insulation sleeve of the recommended ferrule.
  2. Make sure that the ferrule processing dimensions conform to the following figures.

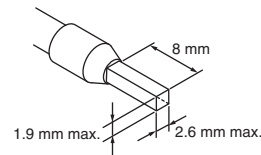

#### Recommended Flat-blade Screwdriver

Use a flat-blade screwdriver to connect and remove wires.

Use the following flat-blade screwdriver.

The following table shows manufacturers and models as of 2015/Dec.

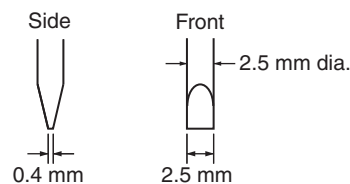

Model	Manufacturer
SZS 0.4×2.5 SZF 0-0.4×2.5 *	Phoenix Contact
ESD0.40×2.5	Wera
0.4×2.5×75 302	Wiha
AEF.2.5×75	Facom
210-719	Wago
SDI 0.4×2.5×75	Weidmuller

\* OMRON's exclusive purchase model XW4Z-00B is available to order as SZF 0-0.4 × 2.5 (manufactured by Phoenix Contact).

# Terms and Conditions Agreement

## **Read and understand this catalog.**

Please read and understand this catalog before purchasing the products. Please consult your OMRON representative if you have any questions or comments.

## **Warranties.**

- (a) Exclusive Warranty. Omron's exclusive warranty is that the Products will be free from defects in materials and workmanship for a period of twelve months from the date of sale by Omron (or such other period expressed in writing by Omron). Omron disclaims all other warranties, express or implied.
- (b) Limitations. OMRON MAKES NO WARRANTY OR REPRESENTATION, EXPRESS OR IMPLIED, ABOUT NON-INFRINGEMENT, MERCHANTABILITY OR FITNESS FOR A PARTICULAR PURPOSE OF THE PRODUCTS. BUYER ACKNOWLEDGES THAT IT ALONE HAS DETERMINED THAT THE PRODUCTS WILL SUITABLY MEET THE REQUIREMENTS OF THEIR INTENDED USE.

Omron further disclaims all warranties and responsibility of any type for claims or expenses based on infringement by the Products or otherwise of any intellectual property right. (c) Buyer Remedy. Omron's sole obligation hereunder shall be, at Omron's election, to (i) replace (in the form originally shipped with Buyer responsible for labor charges for removal or replacement thereof) the non-complying Product, (ii) repair the non-complying Product, or (iii) repay or credit Buyer an amount equal to the purchase price of the non-complying Product; provided that in no event shall Omron be responsible for warranty, repair, indemnity or any other claims or expenses regarding the Products unless Omron's analysis confirms that the Products were properly handled, stored, installed and maintained and not subject to contamination, abuse, misuse or inappropriate modification. Return of any Products by Buyer must be approved in writing by Omron before shipment. Omron Companies shall not be liable for the suitability or unsuitability or the results from the use of Products in combination with any electrical or electronic components, circuits, system assemblies or any other materials or substances or environments. Any advice, recommendations or information given orally or in writing, are not to be construed as an amendment or addition to the above warranty.

See <http://www.omron.com/global/> or contact your Omron representative for published information.

## **Limitation on Liability; Etc.**

OMRON COMPANIES SHALL NOT BE LIABLE FOR SPECIAL, INDIRECT, INCIDENTAL, OR CONSEQUENTIAL DAMAGES, LOSS OF PROFITS OR PRODUCTION OR COMMERCIAL LOSS IN ANY WAY CONNECTED WITH THE PRODUCTS, WHETHER SUCH CLAIM IS BASED IN CONTRACT, WARRANTY, NEGLIGENCE OR STRICT LIABILITY.

Further, in no event shall liability of Omron Companies exceed the individual price of the Product on which liability is asserted.

## **Suitability of Use.**

Omron Companies shall not be responsible for conformity with any standards, codes or regulations which apply to the combination of the Product in the Buyer's application or use of the Product. At Buyer's request, Omron will provide applicable third party certification documents identifying ratings and limitations of use which apply to the Product. This information by itself is not sufficient for a complete determination of the suitability of the Product in combination with the end product, machine, system, or other application or use. Buyer shall be solely responsible for determining appropriateness of the particular Product with respect to Buyer's application, product or system. Buyer shall take application responsibility in all cases.

NEVER USE THE PRODUCT FOR AN APPLICATION INVOLVING SERIOUS RISK TO LIFE OR PROPERTY OR IN LARGE QUANTITIES WITHOUT ENSURING THAT THE SYSTEM AS A WHOLE HAS BEEN DESIGNED TO ADDRESS THE RISKS, AND THAT THE OMRON PRODUCT(S) IS PROPERLY RATED AND INSTALLED FOR THE INTENDED USE WITHIN THE OVERALL EQUIPMENT OR SYSTEM.

## **Programmable Products.**

Omron Companies shall not be responsible for the user's programming of a programmable Product, or any consequence thereof.

## **Performance Data.**

Data presented in Omron Company websites, catalogs and other materials is provided as a guide for the user in determining suitability and does not constitute a warranty. It may represent the result of Omron's test conditions, and the user must correlate it to actual application requirements. Actual performance is subject to the Omron's Warranty and Limitations of Liability.

## **Change in Specifications.**

Product specifications and accessories may be changed at any time based on improvements and other reasons. It is our practice to change part numbers when published ratings or features are changed, or when significant construction changes are made. However, some specifications of the Product may be changed without any notice. When in doubt, special part numbers may be assigned to fix or establish key specifications for your application. Please consult with your Omron's representative at any time to confirm actual specifications of purchased Product.

## **Errors and Omissions.**

Information presented by Omron Companies has been checked and is believed to be accurate; however, no responsibility is assumed for clerical, typographical or proofreading errors or omissions.

**OMRON AUTOMATION AMERICAS HEADQUARTERS** • Chicago, IL USA • 847.843.7900 • 800.556.6766 • www.omron247.com

**OMRON CANADA, INC. • HEAD OFFICE**

Toronto, ON, Canada • 416.286.6465 • 866.986.6766 • www.omron247.com

**OMRON ELECTRONICS DE MEXICO • HEAD OFFICE**

México DF • 52.55.59.01.43.00 • 01-800-226-6766 • mela@omron.com

**OMRON ELECTRONICS DE MEXICO • SALES OFFICE**

Apodaca, N.L. • 52.81.11.56.99.20 • 01-800-226-6766 • mela@omron.com

**OMRON ELETRÔNICA DO BRASIL LTDA • HEAD OFFICE**

São Paulo, SP, Brasil • 55.11.2101.6300 • www.omron.com.br

**OMRON ARGENTINA • SALES OFFICE**

Cono Sur • 54.11.4783.5300

**OMRON CHILE • SALES OFFICE**

Santiago • 56.9.9917.3920

**OTHER OMRON LATIN AMERICA SALES**

54.11.4783.5300

**OMRON EUROPE B.V.** • Wegalaan 67-69, NL-2132 JD, Hoofddorp, The Netherlands. • +31 (0) 23 568 13 00 • www.industrial.omron.eu

*Authorized Distributor:*

**Controllers & I/O**

- Machine Automation Controllers (MAC) • Motion Controllers
- Programmable Logic Controllers (PLC) • Temperature Controllers • Remote I/O

**Robotics**

- Industrial Robots • Mobile Robots

**Operator Interfaces**

- Human Machine Interface (HMI)

**Motion & Drives**

- Machine Automation Controllers (MAC) • Motion Controllers • Servo Systems
- Frequency Inverters

**Vision, Measurement & Identification**

- Vision Sensors & Systems • Measurement Sensors • Auto Identification Systems

**Sensing**

- Photoelectric Sensors • Fiber-Optic Sensors • Proximity Sensors
- Rotary Encoders • Ultrasonic Sensors

**Safety**

- Safety Light Curtains • Safety Laser Scanners • Programmable Safety Systems
- Safety Mats and Edges • Safety Door Switches • Emergency Stop Devices
- Safety Switches & Operator Controls • Safety Monitoring/Force-guided Relays

**Control Components**

- Power Supplies • Timers • Counters • Programmable Relays
- Digital Panel Meters • Monitoring Products

**Switches & Relays**

- Limit Switches • Pushbutton Switches • Electromechanical Relays
- Solid State Relays

**Software**

- Programming & Configuration • Runtime

## X-ON Electronics

Largest Supplier of Electrical and Electronic Components

*Click to view similar products for [Relay Sockets & Fixings](#) category:*

*Click to view products by [Omron](#) manufacturer:*

Other Similar products are found below :

[00008258500](#) [00111976502](#) [0000-825-81-00](#) [60SY4S05](#) [M41G](#) [670-0125](#) [670-0127](#) [6700152](#) [670-0153](#) [6700156](#) [D258-2TS00](#) [70-309](#) [7-1393143-3](#) [7-1616360-5](#) [8000-DG2-5](#) [911361](#) [9-1616339-5](#) [PJF11N](#) [GDA12HA](#) [GDA12HD](#) [GDA12SA](#) [GDA12SD](#) [GDA16HD](#) [GDA22HA](#) [GDA95A](#) [GDA95D](#) [GFX20](#) [PT08QN](#) [PT 1/8 D = 3.2](#) [GUA1](#) [GUA2-11](#) [GUA4-04](#) [GUA4-31](#) [GUM5R](#) [GUR-120](#) [GUR-24](#) [GUR-240](#) [GUR-277](#) [GURX-277](#) [GUW12](#) [GUW95](#) [GUZ63L](#) [R99-11 FOR MY\(NAMEPLATE\)](#) [D52PR2T](#) [RES100K](#) [1310H-HDC](#) [1390H-1ST](#) [1393824-3](#) [1390H-2PC](#) [1410-2SM](#)