

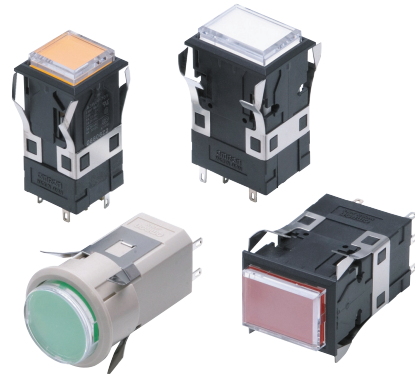

## Large Square-bodied Lighted Pushbutton Switches

- Excellent operating sensitivity.
- Excellent illumination with even surface brightness.
- Three-color models (green, orange, red; chameleon lighting) included in lineup.



 Refer to *Safety Precautions for All Pushbutton Switches/ Indicators* and *Safety Precautions* on page 22.

### List of Models

| Model                 | Appearance |
|-----------------------|------------|
| A3PJ<br>(Rectangular) |            |
| A3PA<br>(Square)      |            |
| A3PT<br>(Round)       |            |

Note: The A3PJ is shown in the figure above as an example.

■ Specifications: Refer to page 12. ■ Panel cutout: Refer to page 19. ■ Dimensions: Refer to page 16.  
 ■ Accessories, replacements, and tools: Refer to pages 10 to 11. ■ Precautions for correct use: Refer to page 22.

## Model Number Structure

**Model Number Legend** ..... The model numbers used to order sets of Units are illustrated below. One set comprises the Pushbutton, Lamp, and Switch.

For more information, refer to Ordering Information (pages 3 to 5).

Some forms may not be available for order depending on the combination of functions and specifications described below. Contact your OMRON sales representative for more detailed information.

(1) A 3 P (2) J - 90 (3) B (4) 1 1 - (5) 24E (6) R ..... Single screen

### (1) Shape of Pushbutton

| Symbol | Shape       |
|--------|-------------|
| J      | Rectangular |
| A      | Square      |
| T      | Round       |

- ▶ Momentary operation: Self-resetting
- ▶ Alternate operation: Self-holding

### (2) Switch Specifications Standard Load

| Symbol | Operation |      |
|--------|-----------|------|
| A      | Momentary | SPDT |
| B      | Alternate |      |
| C      | Momentary | DPDT |
| D      | Alternate |      |

### Microload



| Symbol | Operation |      |
|--------|-----------|------|
| E      | Momentary | SPDT |
| F      | Alternate |      |
| G      | Momentary | DPDT |
| H      | Alternate |      |

- Standard Load 250 VAC, 3 A 30 VDC, 3 A
- Microload 125 VAC, 0.1 A 30 VDC, 0.1 A

Minimum applicable load 5 VDC, 1 mA

- 3PDT models are also available. Select from among the individual products shown on page 9.

### (3) Screen Pattern

| Illumination-only models |  |
|--------------------------|--|
| Symbol                   | Screen pattern   |
| 1                        | Single screen<br> |
| G                        | Chameleon *1<br>  |

\*1. With chameleon models, the whole screen lights red, green, or orange. When not lit, the display is white.

Note: The available rectangular and square models are shown below. Select from among the individual products shown on page 8.

(The square models are only available with horizontal 2-split screen models)

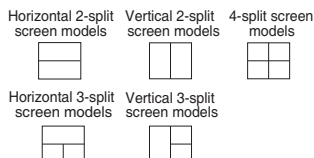

The above diagrams show the Switches with the "OMRON" mark facing down.

- ▶ Colored-illumination models up to the 4-split screen models are available as individual Units. Refer to page 6.

- ▶ "Colored-illumination" models operate in the way shown below:



The built-in LED is colored.

### (4) Case Color

| Symbol | Color      |
|--------|------------|
| 1      | Black      |
| 2      | Light gray |

Note: A3PT models are available in light gray only.

### (5) Lighting

#### Method LED-lighted Models (A3PJ and A3PA Models Only)

| Symbol | Rated voltage |
|--------|---------------|
| 05E    | 5 VDC         |
| 12E    | 12 VAC/VDC    |
| 24E    | 24 VAC/VDC    |

#### LED Lamp-lighted Models (A3PT Only)

| Symbol | Rated voltage |
|--------|---------------|
| 05C    | 5 VDC         |
| 12C    | 12 VDC        |
| 24C    | 24 VDC        |

- A3PJ and A3PA can also be ordered separately. Refer to page 8 for details.

### (6) Color of Pushbutton For LED

| Symbol | Color     |
|--------|-----------|
| R      | Red       |
| O      | orange    |
| G      | green     |
| W      | white     |
| K      | Chameleon |

- The chameleon screen pattern is not available with A3PT models.
- The chameleon screen pattern is only available with 12 or 24-VDC models.

### Number of LED Lamps

| Screen pattern            | A3PJ                     | A3PA | A3PT |
|---------------------------|--------------------------|------|------|
| Single screen             | Models with built-in LED |      | 2    |
| Horizontal 2-split screen | 4 *2                     | 2 *2 | ---  |
| Vertical 2-split screen   |                          | ---  |      |
| Horizontal 3-split screen |                          |      |      |
| Vertical 3-split screen   |                          |      |      |
| 4-split screen            |                          |      |      |

\*2. These split screen models are available only as individual Units. They cannot be ordered as sets.

## Ordering Information

**Ordering as a Set** ..... The model numbers used to order sets of Units are given in the following tables. One set comprises the Pushbutton, Lamp, and Switch.  
(Not all combinations are possible. Ask your OMRON representative for details.)



### Standard Loads

| Output | Lighting  | Case color | Standard load (250 VAC, 3 A; 30 VDC, 4 A) |                   |                                    |                   | Pushbutton color symbol |
|--------|-----------|------------|---|-------------------|------------------------------------|-------------------|-------------------------|
|        |           |            | Momentary operation (Self-resetting)      |                   | Alternate operation (Self-holding) |                   |                         |
|        |           |            | Black                                     | Light gray        | Black                              | Light gray        |                         |
| SPDT   | LED       | 5 VDC      | A3PJ-90A11-05E(1)                         | A3PJ-90A12-05E(1) | A3PJ-90B11-05E(1)                  | A3PJ-90B12-05E(1) | R<br>O<br>G<br>W        |
|        |           | 12 VAC/VDC | A3PJ-90A11-12E(1)                         | A3PJ-90A12-12E(1) | A3PJ-90B11-12E(1)                  | A3PJ-90B12-12E(1) |                         |
|        |           | 24 VAC/VDC | A3PJ-90A11-24E(1)                         | A3PJ-90A12-24E(1) | A3PJ-90B11-24E(1)                  | A3PJ-90B12-24E(1) |                         |
|        | Chameleon | 12 VDC     | A3PJ-90AG1-12EK                           | ---               | A3PJ-90BG1-12EK                    | A3PJ-90BG2-12EK   | *                       |
|        |           | 24 VDC     | A3PJ-90AG1-24EK                           | A3PJ-90AG2-24EK   | A3PJ-90BG1-24EK                    | A3PJ-90BG2-24EK   |                         |
|        |           |            |   |                   |                                    |                   |                         |
| DPDT   | LED       | 5 VDC      | A3PJ-90C11-05E(1)                         | A3PJ-90C12-05E(1) | A3PJ-90D11-05E(1)                  | A3PJ-90D12-05E(1) | R<br>O<br>G<br>W        |
|        |           | 12 VAC/VDC | A3PJ-90C11-12E(1)                         | A3PJ-90C12-12E(1) | A3PJ-90D11-12E(1)                  | A3PJ-90D12-12E(1) |                         |
|        |           | 24 VAC/VDC | A3PJ-90C11-24E(1)                         | A3PJ-90C12-24E(1) | A3PJ-90D11-24E(1)                  | A3PJ-90D12-24E(1) |                         |
|        | Chameleon | 12 VDC     | A3PJ-90CG1-12EK                           | A3PJ-90CG2-12EK   | A3PJ-90DG1-12EK                    | ---               | *                       |
|        |           | 24 VDC     | A3PJ-90CG1-24EK                           | A3PJ-90CG2-24EK   | A3PJ-90DG1-24EK                    | A3PJ-90DG2-24EK   |                         |
|        |           |            |   |                   |                                    |                   |                         |

Note: Enter the desired color symbol for the Pushbutton in (1). (R) = Red, (O) = Orange, (G) = Green, (W) = White.

Example: Red A3PJ-90A11-24ER

\* You can change the screen colors of chameleon models between red, green, and orange, by changing the terminal wiring. Refer to page 18 for details.

### Microloads

| Output | Lighting  | Case color | Microload (125 VAC, 0.1 A; 30 VDC, 0.1 A) |                   | Pushbutton color symbol |
|--------|-----------|------------|---|-------------------|-------------------------|
|        |           |            | Momentary operation (Self-resetting)      |                   |                         |
|        |           |            | Black                                     | Light gray        |                         |
| SPDT   | LED       | 5 VDC      | A3PJ-90E11-05E(1)                         | A3PJ-90E12-05E(1) | R<br>O<br>G<br>W        |
|        |           | 12 VAC/VDC | A3PJ-90E11-12E(1)                         | A3PJ-90E12-12E(1) |                         |
|        |           | 24 VAC/VDC | A3PJ-90E11-24E(1)                         | A3PJ-90E12-24E(1) |                         |
|        | Chameleon | 12 VDC     | A3PJ-90EG1-12EK                           | ---               | *                       |
|        |           | 24 VDC     | A3PJ-90EG1-24EK                           | A3PJ-90EG2-24EK   |                         |
|        |           |            |   |                   |                         |
| DPDT   | LED       | 5 VDC      | A3PJ-90G11-05E(1)                         | ---               | R<br>O<br>G<br>W        |
|        |           | 12 VAC/VDC | A3PJ-90G11-12E(1)                         | A3PJ-90G12-12E(1) |                         |
|        |           | 24 VAC/VDC | A3PJ-90G11-24E(1)                         | A3PJ-90G12-24E(1) |                         |
|        | Chameleon | 12 VDC     | A3PJ-90GG1-12EK                           | ---               | *                       |
|        |           | 24 VDC     | A3PJ-90GG1-24EK                           |                   |                         |
|        |           |            |   |                   |                         |

Note: Enter the desired color symbol for the Pushbutton in (1). (R) = Red, (O) = Orange, (G) = Green, (W) = White.

Example: Red A3PJ-90E11-24ER

\* You can change the screen colors of chameleon models between red, green, and orange, by changing the terminal wiring. Refer to page 18 for details.

Individual models: Refer to pages 7 to 11.  
(The Pushbutton, Lamp, and Switch can be ordered separately.)

■ Specifications: Refer to page 12. ■ Dimensions: Refer to page 16.  
■ Accessories: Refer to pages 10 to 11.

## Ordering Information

**Ordering as a Set**.....The model numbers used to order sets of Units are given in the following tables. One set comprises the Pushbutton, Lamp, and Switch.  
(Not all combinations are possible. Ask your OMRON representative for details.)



### Standard Loads

| Output | Lighting  | Contact type<br>Operation<br>Case color | Standard load (250 VAC, 3 A; 30 VDC, 4 A) |                   |                                    |                   | Pushbutton<br>color symbol |
|--------|-----------|---|---|-------------------|------------------------------------|-------------------|----------------------------|
|        |           |   | Momentary operation (Self-resetting)      |                   | Alternate operation (Self-holding) |                   |                            |
|        |           |   | Black                                     | Light gray        | Black                              | Light gray        |                            |
| SPDT   | LED       | 5 VDC                                   | A3PA-90A11-05E(1)                         | A3PA-90A12-05E(1) | A3PA-90B11-05E(1)                  | A3PA-90B12-05E(1) | R<br>O<br>G<br>W           |
|        |           | 12 VAC/VDC                              | A3PA-90A11-12E(1)                         | A3PA-90A12-12E(1) | A3PA-90B11-12E(1)                  | A3PA-90B12-12E(1) |                            |
|        |           | 24 VAC/VDC                              | A3PA-90A11-24E(1)                         | A3PA-90A12-24E(1) | A3PA-90B11-24E(1)                  | A3PA-90B12-24E(1) |                            |
|        | Chameleon | 12 VDC                                  | A3PA-90AG1-12EK                           | A3PA-90AG2-12EK   | A3PA-90BG1-12EK                    | A3PA-90BG2-12EK   | *                          |
| 24 VDC |           | A3PA-90AG1-24EK                         | A3PA-90AG2-24EK                           | A3PA-90BG1-24EK   | A3PA-90BG2-24EK                    |                   |                            |
| DPDT   | LED       | 5 VDC                                   | A3PA-90C11-05E(1)                         | A3PA-90C12-05E(1) | A3PA-90D11-05E(1)                  | A3PA-90D12-05E(1) | R<br>O<br>G<br>W           |
|        |           | 12 VAC/VDC                              | A3PA-90C11-12E(1)                         | A3PA-90C12-12E(1) | A3PA-90D11-12E(1)                  | A3PA-90D12-12E(1) |                            |
|        |           | 24 VAC/VDC                              | A3PA-90C11-24E(1)                         | A3PA-90C12-24E(1) | A3PA-90D11-24E(1)                  | A3PA-90D12-24E(1) |                            |
|        | Chameleon | 12 VDC                                  | A3PA-90CG1-12EK                           | A3PA-90CG2-12EK   | A3PA-90DG1-12EK                    | A3PA-90DG2-12EK   | *                          |
| 24 VDC |           | A3PA-90CG1-24EK                         | A3PA-90CG2-24EK                           | A3PA-90DG1-24EK   | A3PA-90DG2-24EK                    |                   |                            |

Note: Enter the desired color symbol for the Pushbutton in (1). (R) = Red, (O) = Orange, (G) = Green, (W) = White.

Example:  A3PA-90A11-24E

\* You can change the screen colors of chameleon models between red, green, and orange, by changing the terminal wiring. Refer to page 18 for details.

### Microloads

| Output | Lighting  | Contact type<br>Operation<br>Case color | Microload (125 VAC, 0.1 A; 30 VDC, 0.1 A) |                   | Pushbutton<br>color symbol |
|--------|-----------|---|---|-------------------|----------------------------|
|        |           |   | Momentary operation (Self-resetting)      |                   |                            |
|        |           |   | Black                                     | Light gray        |                            |
| SPDT   | LED       | 5 VDC                                   | A3PA-90E11-05E(1)                         | A3PA-90E12-05E(1) | R<br>O<br>G<br>W           |
|        |           | 12 VAC/VDC                              | A3PA-90E11-12E(1)                         | A3PA-90E12-12E(1) |                            |
|        |           | 24 VAC/VDC                              | A3PA-90E11-24E(1)                         | A3PA-90E12-24E(1) |                            |
|        | Chameleon | 12 VDC                                  | A3PA-90EG1-12EK                           | ---               | *                          |
| 24 VDC |           | A3PA-90EG1-24EK                         | A3PA-90EG2-24EK                           |                   |                            |
| DPDT   | LED       | 5 VDC                                   | ---                                       | ---               | R<br>O<br>G<br>W           |
|        |           | 12 VAC/VDC                              | A3PA-90G11-12E(1)                         | A3PA-90G12-12E(1) |                            |
|        |           | 24 VAC/VDC                              | A3PA-90G11-24E(1)                         | A3PA-90G12-24E(1) |                            |
|        | Chameleon | 12 VDC                                  | A3PA-90GG1-12EK                           | ---               | *                          |
| 24 VDC |           | A3PA-90GG1-24EK                         | ---                                       |                   |                            |

Note: Enter the desired color symbol for the Pushbutton in (1). (R) = Red, (O) = Orange, (G) = Green, (W) = White.

Example:  A3PA-90E11-24E

\* You can change the screen colors of chameleon models between red, green, and orange, by changing the terminal wiring. Refer to page 18 for details.

Individual models: Refer to pages 7 to 11.  
(The Pushbutton, Lamp, and Switch can be ordered separately.)

■ Specifications: Refer to page 12. ■ Dimensions: Refer to page 16.  
■ Accessories: Refer to pages 10 to 11.

## Ordering Information

**Ordering as a Set** ..... The model numbers used to order sets of Units are given in the following tables. One set comprises the Pushbutton, Lamp, and Switch.



### Standard Loads

| Output | Lighting | Case color | Standard load (250 VAC, 3 A; 30 VDC, 4 A) |                   | Pushbutton color symbol |
|--------|----------|------------|---|-------------------|-------------------------|
|        |          |            | Contact type                              | Operation         |                         |
|        |          |            | Light gray                                | Light gray        |                         |
| SPDT   | LED lamp | 24 VDC     | A3PT-90A12-24C(1)                         | A3PT-90B12-24C(1) | R O G W                 |
| DPDT   | LED lamp | 24 VDC     | A3PT-90C12-24C(1)                         | A3PT-90D12-24C(1) | R O G W                 |

Note: Enter the desired color symbols for the Pushbutton in (1) and (2). (R) = Red, (O) = Orange, (G) = Green, (W) = White.

Example: (Red) A3PT-90A12-24C(R)



### Microloads

| Output | Lighting | Case color | Microload (125 VAC, 0.1 A; 30 VDC, 0.1 A) |            |
|--------|----------|------------|---|------------|
|        |          |            | Contact type                              | Operation  |
|        |          |            | Light gray                                | Light gray |
| SPDT   | LED lamp | 24 VDC     | A3PT-90E12-24C(1)                         | R O G W    |
| DPDT   | LED lamp | 24 VDC     | A3PT-90G12-24C(1)                         | G W        |

Note: Enter the desired color symbols for the Pushbutton in (1). (R) = Red, (O) = Orange, (G) = Green, (W) = White.

Example: (Red) A3PT-90E12-24C(R)

Individual models: Refer to pages 7 to 11.  
(The Pushbutton, Lamp, and Switch can be ordered separately.)

■ Specifications: Refer to page 12. ■ Dimensions: Refer to page 16.  
■ Accessories: Refer to pages 10 to 11.

## Ordering Information

### Illumination-only and Colored-illumination LED Models

“Illumination only” describes LED models for which the screen color is the same whether the LED is lit or not. The screen simply becomes brighter when the LED lights.

Example: Red LED

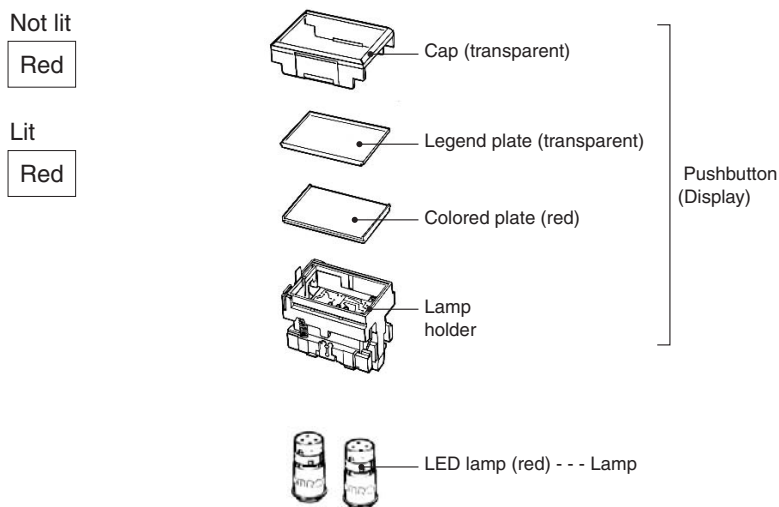

“Colored illumination” describes LED models for which the screen color is white when the LED is not lit and changes to the color of the LED lamp when the LED is lit.

Example: Red LED

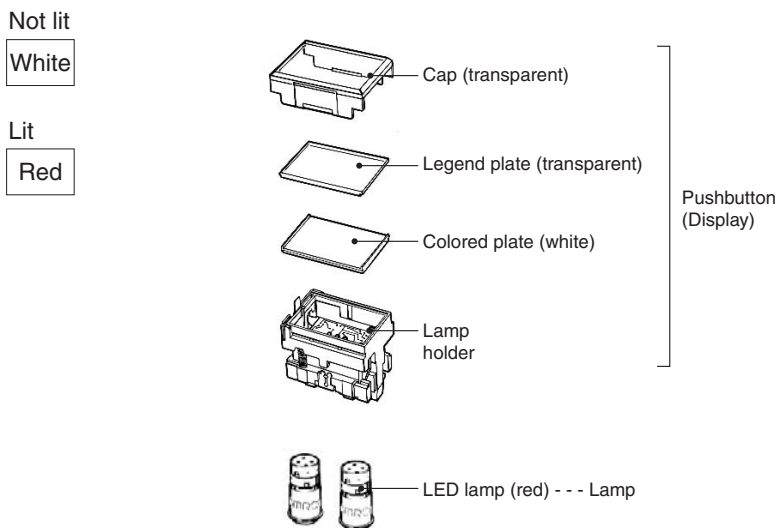

**Ordering: With colored-illumination models, order the Pushbutton, Lamp, and Switch as shown in the following table.**

| Pushbutton  | Lamp  | Switch                              |
|---|---|-------------------------------------|
| Select the LED lamp-lighted model required from the selection on page 8. Each assembly includes the number of white colored plates required to enable colored illumination for the corresponding screen-split configuration. For example, 4-split screen models include 4 white colored plates. | Select the LED lamps to suit your desired coloration from the selection on page 9. Number of necessary LED lamps (standard)<br>A3PJ (rectangular): 4<br>A3PA (square): 2<br>A3PT (round): 2 | Select from the Switches on page 9. |

## Ordering Information

**Ordering Individually** ..... Pushbuttons, Lamps, and Switches can be ordered separately. Combinations that are not available as sets can be created using individual Units. Also, store the parts as spares for maintenance and repairs.

### LED-lighted (Single screen models only)/

#### Chameleon Models

(LED is built into the Pushbutton.)

**Pushbutton**

Round (A3PT) models not available.

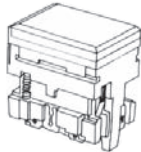

· For Pushbutton Switch  
A3P□-5□□□-□□E

### LED Lamp-lighted Models

(LED lamp and Pushbutton are separate.)

**Pushbutton**

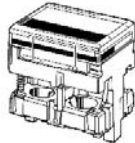

· For Pushbutton Switch  
A3P□-502□

**Lamp (LED Lamp) \*2**



SLL-□□E□

**Switch \*1**

Round (A3PT) models not available.

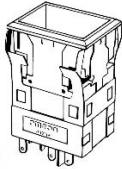

· For Pushbutton Switch  
A3P□-7□□□-□

**Switch \*1**

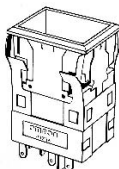

· For Pushbutton Switch  
A3P□-7□□□-□

\*1. The Switch is compatible with LED-lighted models and LED lamp-lighted models.  
\*2. Number of necessary LED lamps.

| Screen pattern            | A3PJ | A3PA | A3PT |
|---------------------------|------|------|------|
| Single screen             | 4    | 2    | 2    |
| Horizontal 2-split screen |      | 2    | ---  |
| Vertical 2-split screen   |      | /    |      |
| Vertical 3-split screen   |      |      |      |
| Horizontal 3-split screen |      |      |      |
| 4-split screen            |      |      |      |

Ordering set combinations: Refer to page 3 to 5.





■ Specifications: Refer to page 12. ■ Dimensions: Refer to page 16.  
■ Accessories: Refer to pages 10 to 11.

## Ordering Information

**Ordering Individually** .....Pushbuttons, Lamps, and Switches can be ordered separately. Combinations that are not available as sets can be created using individual Units. Also, store the parts as spares for maintenance and repairs.

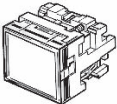







Pushbutton

### LED-lighted Models (LED is built-in.)

| Appearance  | Split-screen color (color symbol) |   | White (W)                | Red (R)                  | Green (G)                | Orange (O)               | Selection precautions  |
|---|-----------------------------------|---|--------------------------|--------------------------|--------------------------|--------------------------|--|
| Rectangular models<br> | Single screen                     |  | <b>A3PJ-5701</b><br>-□□E | <b>A3PJ-5702</b><br>-□□E | <b>A3PJ-5703</b><br>-□□E | <b>A3PJ-5706</b><br>-□□E | <ul style="list-style-type: none"> <li>Enter the voltage to be used in the□□at the end of the model number.</li> <li>Examples of voltages used:<br/>5V=0 5 E<br/>12V=1 2 E<br/>24V=2 4 E</li> <li>For the color of the shaded part, select the model according to the colors given at the top of the table.</li> </ul> |
| Square models<br>      | Single screen                     |  | <b>A3PA-5701</b><br>-□□E | <b>A3PA-5702</b><br>-□□E | <b>A3PA-5703</b><br>-□□E | <b>A3PA-5706</b><br>-□□E |  |

Note: 1. A cap, legend plate (transparent), colored plate, white plunger case, and LED (with a current-limiting resistor) are built into the standard lighting unit.  
 2. Split-screen coloring configurations are given with the OMRON mark on the Switch facing down.  
 3. The LED is built-in and cannot be replaced individually.

### LED Lamp-lighted Models (LED is not built-in.)

| Appearance                 | Rectangular models  |                  | Square models   |                  | Round models  |                  | Selection precautions  |                |       |     |       |        |               |   |   |   |   |                            |   |   |   |   |                          |   |   |   |   |                            |   |   |   |   |                          |   |   |   |   |                |   |   |   |   |
|----------------------------|---|------------------|---|------------------|---|------------------|--|----------------|-------|-----|-------|--------|---------------|---|---|---|---|----------------------------|---|---|---|---|--------------------------|---|---|---|---|----------------------------|---|---|---|---|--------------------------|---|---|---|---|----------------|---|---|---|---|
|                            | Screen  | Model            | Screen  | Model            | Screen  | Model            |  |                |       |     |       |        |               |   |   |   |   |                            |   |   |   |   |                          |   |   |   |   |                            |   |   |   |   |                          |   |   |   |   |                |   |   |   |   |
| Single screen              |  | <b>A3PJ-5021</b> |  | <b>A3PA-5021</b> |  | <b>A3PT-5021</b> | <ul style="list-style-type: none"> <li>Parts included: Colored plates (white, red, green, and orange), a legend plate (transparent), and a light baffle (split-screen models only) are included. Use the appropriate combination for the LED coloring required.</li> <li>The number of white colored plates required to enable colored illumination for the corresponding screen-split configuration is included. (For example, 4-split screen models include 4 white colored plates).</li> <li>The number of colored plates included for each model are shown in the following table.</li> </ul> <table border="1"> <thead> <tr> <th>Screen pattern</th> <th>White</th> <th>Red</th> <th>Green</th> <th>Orange</th> </tr> </thead> <tbody> <tr> <td>Single screen</td> <td>1</td> <td>1</td> <td>1</td> <td>1</td> </tr> <tr> <td>Horizontal 2-split screens</td> <td>2</td> <td>1</td> <td>1</td> <td>1</td> </tr> <tr> <td>Vertical 2-split screens</td> <td>2</td> <td>1</td> <td>1</td> <td>1</td> </tr> <tr> <td>Horizontal 3-split screens</td> <td>3</td> <td>2</td> <td>2</td> <td>2</td> </tr> <tr> <td>Vertical 3-split screens</td> <td>3</td> <td>2</td> <td>2</td> <td>2</td> </tr> <tr> <td>4-split screen</td> <td>4</td> <td>1</td> <td>1</td> <td>1</td> </tr> </tbody> </table> | Screen pattern | White | Red | Green | Orange | Single screen | 1 | 1 | 1 | 1 | Horizontal 2-split screens | 2 | 1 | 1 | 1 | Vertical 2-split screens | 2 | 1 | 1 | 1 | Horizontal 3-split screens | 3 | 2 | 2 | 2 | Vertical 3-split screens | 3 | 2 | 2 | 2 | 4-split screen | 4 | 1 | 1 | 1 |
| Screen pattern             | White   | Red              | Green   | Orange           |   |                  |  |                |       |     |       |        |               |   |   |   |   |                            |   |   |   |   |                          |   |   |   |   |                            |   |   |   |   |                          |   |   |   |   |                |   |   |   |   |
| Single screen              | 1   | 1                | 1   | 1                |   |                  |  |                |       |     |       |        |               |   |   |   |   |                            |   |   |   |   |                          |   |   |   |   |                            |   |   |   |   |                          |   |   |   |   |                |   |   |   |   |
| Horizontal 2-split screens | 2   | 1                | 1   | 1                |   |                  |  |                |       |     |       |        |               |   |   |   |   |                            |   |   |   |   |                          |   |   |   |   |                            |   |   |   |   |                          |   |   |   |   |                |   |   |   |   |
| Vertical 2-split screens   | 2   | 1                | 1   | 1                |   |                  |  |                |       |     |       |        |               |   |   |   |   |                            |   |   |   |   |                          |   |   |   |   |                            |   |   |   |   |                          |   |   |   |   |                |   |   |   |   |
| Horizontal 3-split screens | 3   | 2                | 2   | 2                |   |                  |  |                |       |     |       |        |               |   |   |   |   |                            |   |   |   |   |                          |   |   |   |   |                            |   |   |   |   |                          |   |   |   |   |                |   |   |   |   |
| Vertical 3-split screens   | 3   | 2                | 2   | 2                |   |                  |  |                |       |     |       |        |               |   |   |   |   |                            |   |   |   |   |                          |   |   |   |   |                            |   |   |   |   |                          |   |   |   |   |                |   |   |   |   |
| 4-split screen             | 4   | 1                | 1   | 1                |   |                  |  |                |       |     |       |        |               |   |   |   |   |                            |   |   |   |   |                          |   |   |   |   |                            |   |   |   |   |                          |   |   |   |   |                |   |   |   |   |
| Horizontal 2-split screen  |  | <b>A3PJ-5022</b> |  | <b>A3PA-5022</b> | ---   | ---              |  |                |       |     |       |        |               |   |   |   |   |                            |   |   |   |   |                          |   |   |   |   |                            |   |   |   |   |                          |   |   |   |   |                |   |   |   |   |
| Vertical 2-split screen    |  | <b>A3PJ-5023</b> | ---   | ---              | ---   | ---              |  |                |       |     |       |        |               |   |   |   |   |                            |   |   |   |   |                          |   |   |   |   |                            |   |   |   |   |                          |   |   |   |   |                |   |   |   |   |
| Horizontal 3-split screen  |  | <b>A3PJ-5024</b> | ---   | ---              | ---   | ---              |  |                |       |     |       |        |               |   |   |   |   |                            |   |   |   |   |                          |   |   |   |   |                            |   |   |   |   |                          |   |   |   |   |                |   |   |   |   |
| Vertical 3-split screen    |  | <b>A3PJ-5025</b> | ---   | ---              | ---   | ---              |  |                |       |     |       |        |               |   |   |   |   |                            |   |   |   |   |                          |   |   |   |   |                            |   |   |   |   |                          |   |   |   |   |                |   |   |   |   |
| 4-split screen             |  | <b>A3PJ-5026</b> | ---   | ---              | ---   | ---              |  |                |       |     |       |        |               |   |   |   |   |                            |   |   |   |   |                          |   |   |   |   |                            |   |   |   |   |                          |   |   |   |   |                |   |   |   |   |

\* The following types of colored plates are included with Horizontal and Vertical 3-split Screen Switches.  
 White: One colored plate for a 2-split screen and two colored plates for a 4-split screen.  
 Red, green, or orange: One colored plate for a 2-split screen and one colored plates for a 4-split screen.

Ordering set combinations: Refer to page 3 to 5.

■ Specifications: Refer to page 12. ■ Dimensions: Refer to page 16.  
 ■ Accessories: Refer to pages 10 to 11.





## Ordering Information

**Ordering Individually** ..... Pushbuttons, Lamps, and Switches can be ordered separately. Combinations that are not available as sets can be created using individual Units. Also, store the parts as spares for maintenance and repairs.

**Pushbutton** (For information on mounting of LED lamps, refer to page 23.)

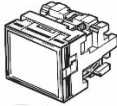
### Chameleon Models (with Built-in LED)

| Appearance   | Rated voltage | Chameleon pushbutton switch |
|--|---------------|-----------------------------|
| <br>Rectangular | 12 VDC        | <b>A3PJ-5800-12E</b>        |
|  | 24 VDC        | <b>A3PJ-5800-24E</b>        |
| <br>Square      | 12 VDC        | <b>A3PA-5800-12E</b>        |
|  | 24 VDC        | <b>A3PA-5800-24E</b>        |

Note: 1. With chameleon models the whole screen lights red, green, or orange (i.e., red and green simultaneously).  
 2. A cap, legend plate (transparent), white colored plate, and LED (with a current-limiting resistor) are built into the Pushbutton.

### LED Lamp

| Color  | Voltage | 5 VDC           | 12 VDC          | 24 VDC          | Applicable cap (color)<br>(colored plate) | Selection precautions  |
|--------|---------|-----------------|-----------------|-----------------|---|--|
|        |         | Model (DC only) | Model (DC only) | Model (DC only) |   |  |
| Red    |         | SLL-05ER        | SLL-12ER        | SLL-24ER        | Red                                       | In the standard setup, 4 LED lamps are used with A3PJ models and 2 LED lamps are used with A3PA and A3PT models. |
| Yellow |         | SLL-05EY        | SLL-12EY        | SLL-24EY        | Orange                                    |  |
| Green  |         | SLL-05EG        | SLL-12EG        | SLL-24EG        | Green                                     |  |
| White  |         | SLL-05EW        | SLL-12EW        | SLL-24EW        | White                                     |  |

**Switch** (LED models)

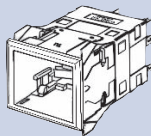
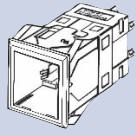
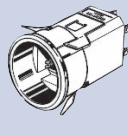
| Appearance          |                          |                     |                     | Rectangular models  | Square models  | Round models  | Selection precautions |
|---------------------|--------------------------|---------------------|---------------------|---|--|---|-----------------------|
|                     |                          |                     |                     |  |  |  |                       |
| Contact type        | Switch Number of outputs | Operation           | Model               | Model   | Model  |   |                       |
|                     |                          |                     | Standard load       | Silver alloy contact  | 1c   |   | Momentary operation   |
| Alternate operation | A3PJ-7020-1              | A3PA-7020-1         |                     |   |  | A3PT-7020-2   |                       |
| 2c                  | Momentary operation      | A3PJ-7030-1         |                     |   | A3PA-7030-1  | A3PT-7030-2   |                       |
|                     | Alternate operation      | A3PJ-7040-1         |                     |   | A3PA-7040-1  | A3PT-7040-2   |                       |
| 3c                  | Momentary operation      | A3PJ-7150-1         |                     | ---   | ---  |   |                       |
|                     | Alternate operation      | A3PJ-7160-1         |                     | ---   | ---  |   |                       |
| Microload           | Gold alloy contact       | 1c                  | Momentary operation | A3PJ-7050-1   | A3PA-7050-1  | A3PT-7050-2   |                       |
|                     |                          |                     | Alternate operation | A3PJ-7060-1   | A3PA-7060-1  | A3PT-7060-2   |                       |
|                     |                          | 2c                  | Momentary operation | A3PJ-7070-1   | A3PA-7070-1  | A3PT-7070-2   |                       |
|                     |                          |                     | Alternate operation | A3PJ-7080-1   | A3PA-7080-1  | A3PT-7080-2   |                       |
|                     | 3c                       | Momentary operation | A3PJ-7170-1         | ---   | ---  |   |                       |
|                     |                          | Alternate operation | A3PJ-7180-1         | ---   | ---  |   |                       |







Ordering set combinations: Refer to page 3 to 5.

■ Specifications: Refer to page 12. ■ Dimensions: Refer to page 16.  
 ■ Accessories: Refer to pages 10 to 11.

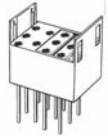
## Ordering Information



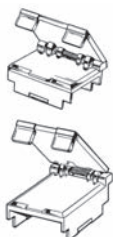





### Accessories, Replacements, and Tools

#### Accessories

| Name                | Appearance  | Classification  |            | Rectangular       | Square            | Application precautions   |
|---------------------|---|---|------------|-------------------|-------------------|---|
| Socket              |    | Wire-wrap terminal  |            | <b>A3PJ-4101</b>  | <b>A3PA-4101</b>  | <ul style="list-style-type: none"> <li>The Socket cannot be used with when mounting multiple Switches or with 3C models.</li> <li>You can use the same Sockets for the A3P Ultra Bright Lighted Pushbutton Switches.</li> </ul>   |
|                     |   | PCB terminal  |            | <b>A3PJ-4102</b>  | <b>A3PA-4102</b>  |   |
|                     |   | Solder terminal   |            | <b>A3PJ-4103</b>  | <b>A3PA-4103</b>  |   |
| Barrier             |    | Short edge barrier (Horizontal mounting) (1 pair)           | Black      | <b>A3PJ-4001</b>  | <b>A3PA-4001</b>  | <ul style="list-style-type: none"> <li>The purpose of the barrier is to prevent malfunctioning and to improve design image of the mounting panel.</li> <li>Intermediate barrier × 1.</li> <li>Edge barriers × 1 pair (2 Units).</li> <li>Mount short barriers horizontally.</li> <li>Mount long barriers vertically.</li> <li>For details on mounting, refer to page 23.</li> <li>You can use the same Sockets for the A3P Ultra Bright Lighted Pushbutton Switches.</li> </ul> |
|                     |   |   | Light gray | <b>A3PJ-4002</b>  | <b>A3PA-4002</b>  |   |
|                     |    | Long edge barrier (Vertical mounting) (1 pair)              | Black      | <b>A3PJ-4004</b>  | ---               |   |
|                     |   |   | Light gray | <b>A3PJ-4005</b>  | ---               |   |
|                     |    | Short intermediate barrier (Horizontal mounting)            | Black      | <b>A3PJ-4007</b>  | <b>A3PA-4007</b>  |   |
|                     |   |   | Light gray | <b>A3PJ-4008</b>  | <b>A3PA-4008</b>  |   |
|                     |    | Long intermediate barrier (Vertical mounting)               | Black      | <b>A3PJ-4010</b>  | ---               |   |
|                     |   |   | Light gray | <b>A3PJ-4011</b>  | ---               |   |
| Switch guard        |   | For horizontal mounting (with OMRON logo facing down)       |            | <b>A3PJN-5050</b> | <b>A3PAN-5050</b> | <ul style="list-style-type: none"> <li>Can be used by exchanging with the cap.</li> <li>Cannot be used with seal cover.</li> <li>Can be used with barrier.</li> <li>Use horizontal mounting guard for consecutive horizontal mounting, and use vertical mounting guard for consecutive vertical mounting.</li> <li>You can use the same Sockets for the A3P Ultra Bright Lighted Pushbutton Switches.</li> </ul>  |
|                     |   | For vertical mounting (with OMRON logo facing to the right) |            | <b>A3PJN-5055</b> | <b>A3PAN-5055</b> |   |
| Seal cover          |  | ---   | ---        | <b>A3PJ-5060</b>  | <b>A3PA-5060</b>  | <ul style="list-style-type: none"> <li>Cannot be used with barrier and/or switch guard.</li> <li>For details on mounting, refer to page 23.</li> <li>Cap is manufactured from vinyl chloride.</li> <li>You can use the same Sockets for the A3P Ultra Bright Lighted Pushbutton Switches.</li> </ul>  |
| Long mounting plate |  | ---   | ---        | <b>A3PJ-3002</b>  | ---               | <ul style="list-style-type: none"> <li>Use when vertically mounting individual (with barrier) or multiple Switches (in standard mounting style and with barrier). Since a short mounting plate is attached to the Switch, replace it with the long one.</li> <li>You can use the same Sockets for the A3P Ultra Bright Lighted Pushbutton Switches.</li> </ul>  |

## Ordering Information

### Accessories

| Name                  | Appearances   | Classification   | A3PJ       | A3PA        | Application precautions |  |
|-----------------------|---|--|------------|-------------|-------------------------|--|
| Colored plate for LED |    | Single screen<br>             | White      | A3PJ-5301   | A3PA-5301               | <ul style="list-style-type: none"> <li>• Keep mounted at all times. If the colored plate is lost or damaged, contact OMRON.</li> <li>• Use in accordance with coloring of the built-in LED.</li> <li>• For details on mounting, refer to page 23.</li> <li>• You cannot use the same Colored Plates for Incandescent Lamps for the A3P Ultra Bright Lighted Push-button Switches.</li> </ul> |
|                       |   |  | Red        | A3PJ-5302   | A3PA-5302               |  |
|                       |   |  | Green      | A3PJ-5303   | A3PA-5303               |  |
|                       |   |  | Yellow     | A3PJ-5305   | A3PA-5305               |  |
|                       |   |  | Orange     | A3PJ-5306   | A3PA-5306               |  |
|                       |   | Horizontal 2-split screen<br> | White      | A3PJ-5321   | A3PA-5321               |  |
|                       |   |  | Red        | A3PJ-5322   | A3PA-5322               |  |
|                       |   |  | Green      | A3PJ-5323   | A3PA-5323               |  |
|                       |   |  | Yellow     | A3PJ-5325   | A3PA-5325               |  |
|                       |   |  | Orange     | A3PJ-5326   | A3PA-5326               |  |
|                       |   | Vertical 2-split screen<br>   | White      | A3PJ-5331   | ---                     |  |
|                       |   |  | Red        | A3PJ-5332   | ---                     |  |
|                       |   |  | Yellow     | A3PJ-5335   | ---                     |  |
|                       |   |  | Orange     | A3PJ-5336   | ---                     |  |
|                       |   | 4-split screen<br>            | White      | A3PJ-5361   | ---                     |  |
|                       |   |  | Red        | A3PJ-5362   | ---                     |  |
| Green                 | A3PJ-5363   |  | ---        |             |                         |  |
| Orange                | A3PJ-5366   |  | ---        |             |                         |  |
| Light baffle          |   | Horizontal 2-split screen  |            | A3PJ-4302   | A3PA-4302               | <ul style="list-style-type: none"> <li>• Keep mounted at all times. If the light baffle is lost, contact OMRON.</li> <li>• Used in LED lamp-lighted models. Cannot be used in LED-lighted models.</li> <li>• You cannot use the same Colored Plates for Incandescent Lamps for the A3P Ultra Bright Lighted Push-button Switches.</li> </ul>   |
|                       |   | Vertical 2-split screen  |            | A3PJ-4303   | ---                     |  |
|                       |   | Horizontal 3-split screen<br> | Long axis  | A3PJ-4304   | ---                     |  |
|                       |   |  | Short axis | A3PJ-4305   | ---                     |  |
|                       |   | Vertical 3-split screen  | Long axis  | A3PJ-4306   | ---                     |  |
|                       |   | 4-split screen   | Long axis  | A3PJ-4304   | ---                     |  |
| Legend plate          |  | Transparent legend plate   |            | A3PJ-5202   | A3PA-5202               | <ul style="list-style-type: none"> <li>• A transparent legend plate is mounted on the Pushbutton.</li> <li>• You cannot use the same Colored Plates for Incandescent Lamps for the A3P Ultra Bright Lighted Push-button Switches.</li> </ul>   |
|                       |   | Milk-white legend plate  |            | A3PJ-5201   | A3PA-5201               |  |
| Cap                   |  | Transparent cap  |            | A3PJ-5600   | A3PA-5600               | <ul style="list-style-type: none"> <li>• You can use the same Sockets for the A3P Ultra Bright Lighted Push-button Switches.</li> <li>• The surface is crimp-processed, so there is no reflection.</li> <li>• You can use the same Sockets for the A3P Ultra Bright Lighted Push-button Switches.</li> </ul>   |
|                       |   | Crimp-processed transparent cap  |            | A3PJ-5600-A | A3PA-5600-A             |  |

### Tools

| Name      | Appearance  | Classification | Model     | Application precautions   |
|-----------|---|----------------|-----------|---|
| Extractor |  | ---            | A3PJ-5080 | <ul style="list-style-type: none"> <li>• Use to extract components when replacing the Pushbutton.</li> <li>• You can use the same Sockets for the A3P Ultra Bright Lighted Push-button Switches.</li> </ul> |

## Specifications

### Approved Standard Ratings

UL (File No. E41515), CSA (File No. LR45258)

Standard Load: 5 A at 125 VAC  
3 A at 250 VAC  
Microload: 0.1 A at 125 VAC  
0.1 A at 30 VDC

Note: 1. Certification has been obtained for the Switch Unit.  
For detailed information on individual products that have received certification, consult your supplier.  
2. Only Switch output 1c and 2c are certified.

### CCC (GB/T14048.5)

Standard Load: 3 A at 250 VAC  
4 A at 30 VDC  
Microload: 0.1 A at 125 VAC  
0.1 A at 30 VDC

Note: Only Switch output 1c and 2c are certified.

## Ratings

### Contact Ratings

#### Silver Alloy Contacts (for Standard Loads)

| Rated voltage (V) | Non-inductive load (A) |    |           |    | Inductive load (A) |    |            |    |
|-------------------|------------------------|----|-----------|----|--------------------|----|------------|----|
|                   | Resistive load         |    | Lamp load |    | Inductive load     |    | Motor load |    |
|                   | NC                     | NO | NC        | NO | NC                 | NO | NC         | NO |
| 125 VAC           | 5                      |    | 0.7       |    | 3                  |    | 1.3        |    |
| 250 VAC           | 3                      |    | 0.5       |    | 2                  |    | 0.8        |    |
| 8 VDC             | 5                      |    | 2         |    | 4                  |    | 3          |    |
| 14 VDC            | 5                      |    | 2         |    | 4                  |    | 3          |    |
| 30 VDC            | 4                      |    | 2         |    | 3                  |    | 3          |    |
| 125 VDC           | 0.4                    |    | 0.05      |    | 0.4                |    | 0.05       |    |
| 250 VDC           | 0.2                    |    | 0.03      |    | 0.2                |    | 0.03       |    |

Note: 1. The above values are for steady-state currents.  
2. Inductive load: Power factor = 0.4; time constant = 7 ms.  
3. The lamp load has an inrush current of 10 times the steady-state current.  
4. The motor load has an inrush current of 6 times the steady-state current.

Standard testing condition

- (1) Ambient temperature: 20 ± 2°C
- (2) Ambient humidity: 65 ± 5%RH
- (3) Operating frequency: 20 times/min.

#### Gold Alloy Contacts (for Microloads)

|                         |  |
|-------------------------|--|
| Rated voltage (V)       | 0.1 A at 30 VDC (resistive load);<br>0.1 A at 125 VAC (resistive load) |
| Minimum applicable load | 1 mA at 5 VDC  |

## LED Ratings

### LED for LED-lighted Models

#### Single screen

| Model           |               | A3PJ/M2PJ     |               |               | A3PA/M2PA     |               |              |
|-----------------|---------------|---------------|---------------|---------------|---------------|---------------|--------------|
| Applied voltage | Rated voltage | Current       |               |               | Current       |               |              |
|                 |               | Red, white    | Orange        | Green         | Red, white    | Orange        | Green        |
| 5 VDC±5%        | 5 VDC         | Approx. 40 mA | Approx. 20 mA | Approx. 18 mA | Approx. 20 mA | Approx. 10 mA | Approx. 9 mA |
| 12 VAC/VDC ±5%  | 12 VAC/VDC    | Approx. 20 mA | Approx. 10 mA | Approx. 8 mA  | Approx. 10 mA | Approx. 5 mA  | Approx. 4 mA |
| 24 VAC/VDC ±5%  | 24 VAC/VDC    | Approx. 10 mA | Approx. 5 mA  | Approx. 4 mA  | Approx. 10 mA | Approx. 5 mA  | Approx. 4 mA |

### LED for Chameleon Models

| Applied voltage | Rated voltage | Current       |               |
|-----------------|---------------|---------------|---------------|
|                 |               | Green         | Red           |
| 12 VDC±5%       | 12 VDC        | Approx. 26 mA | Approx. 20 mA |
| 24 VDC±5%       | 24 VDC        | Approx. 13 mA | Approx. 10 mA |

### LED Lamp (for LED Lamp-lighted Models)

| Type    | Applied voltage | Rated voltage | Current         | Model    |
|---------|-----------------|---------------|-----------------|----------|
| DC only | 5 VDC±5%        | 5 VDC         | Approx. 30 mA   | SLL-05E□ |
|         | 12 VDC±5%       | 12 VDC        | Approx. 15 mA   | SLL-12E□ |
|         | 24 VDC±5%       | 24 VDC        | Approx. 12.5 mA | SLL-24E□ |

#### • Mis-lighting of the LED

The LED lights with approx. 0.1 mA or less of micro-current. Take a countermeasure like adding a resistor to prevent mis-lighting in parallel to the LED.

The micro-current varies with the machine (leak current or stray capacity between cables, etc.). Select resistance value and allowable power consumption that meet the actual current.

#### (Circuit example)

In case of using 24 VAC/VDC, Direct lighting

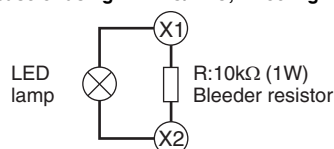

## Characteristics

|                                 |   |   |
|---------------------------------|---|---|
| Operating frequency             | Mechanical  | 120 operations/minute max. *1   |
|                                 | Electrical  | 30 operations/minute max.   |
| Insulation resistance           |   | 100 MΩ min. (at 500 VDC)  |
| Contact resistance              | Standard load   | 40 mΩ max. (initial value)  |
|                                 | Microload   | 40 mΩ max. (initial value)  |
| Dielectric strength             | Between terminals of same polarity                        | 1,000 VAC, 50/60 Hz for 1 minute *2   |
|                                 | Between terminals of different polarity                   | 2,000 VAC, 50/60 Hz for 1 minute  |
|                                 | Between current-carrying metal part and ground            | 2,000 VAC, 50/60 Hz for 1 minute  |
|                                 | Between each terminal and non-current-carrying metal part | 2,000 VAC, 50/60 Hz for 1 minute  |
|                                 | Between lamp terminals                                    | 1,000 VAC, 50/60 Hz for 1 minute *3   |
| Vibration resistance            | Malfunction   | 10 to 55 Hz, 1.5 mm double amplitude (1 ms max.)  |
| Shock resistance                | Destruction   | 500 m/s <sup>2</sup> max.   |
|                                 | Malfunction   | 200 m/s <sup>2</sup> max. (1 ms max.)   |
| Life expectancy                 | Mechanical  | Momentary operation models: 1,000,000 operations min.<br>Alternate operation models: 200,000 operations min.<br>(One operation consists of set and reset operations.) |
|                                 | Electrical  | 100,000 operations min.   |
| Weight                          |   | Approx. 30 g  |
| Inrush current                  | NC  | Silver contact: 10 A max.   |
|                                 | NO  | Silver contact: 10 A max.   |
| Ambient operating temperature   |   | LED-lighted models: -10°C to 40°C<br>(with no icing or condensation)  |
| Ambient operating humidity      |   | 35% to 85%RH  |
| Ambient storage temperature     |   | -25°C to 65°C   |
| Degree of protection            |   | IP40  |
| Electric shock protection class |   | Class II  |
| PTI (proof tracking index)      |   | 175   |
| Pollution degree                |   | 3 (IEC947-5-1)  |

\*1. With alternate operation models, 60 operations/minute max. One operation cycle consists of set and reset operations.

\*2. 600 VAC for microloads.

\*3. With no LED lamp mounted.

## Operating Characteristics

| Operating Characteristics | Model    | A3PJ series                |                            | A3PA series                |                            | A3PT series                |                            |
|---------------------------|----------|----------------------------|----------------------------|----------------------------|----------------------------|----------------------------|----------------------------|
|                           |          | Momentary operation models | Alternate operation models | Momentary operation models | Alternate operation models | Momentary operation models | Alternate operation models |
| Operating force           | OF max.  | 5.88 N                     | 6.86 N                     | 5.88 N                     | 6.86 N                     | 3.92 N                     | 4.90 N                     |
| Releasing force           | RF min.  | 0.39 N                     | 0.29 N                     | 0.39 N                     | 0.29 N                     | 0.39 N                     | 0.29 N                     |
| Total travel              | TT       | Approx. 3.5 mm             | Approx. 3.5 mm             | Approx. 3.5 mm             | Approx. 3.5 mm             | Approx. 3.5 mm             | Approx. 3.5 mm             |
| Pretravel                 | PT max.  | 3 mm                       | 3 mm                       | 3 mm                       | 3 mm                       | 3 mm                       | 3 mm                       |
| Lock travel alternate     | LTA min. | ---                        | 0.5 mm                     | ---                        | 0.5 mm                     | ---                        | 0.5 mm                     |

# Nomenclature

## Model Structure

| Lighting method | LED-lighted models<br>(LED is built-in.) |                     | LED lamp-lighted models<br>(LED lamp is not built-in.) |                           |                           |               |
|-----------------|--|---------------------|--|---------------------------|---------------------------|---------------|
|                 | Models                                   | A3PJ                | A3PA   | A3PJ                      | A3PA                      | A3PT          |
| Screen patterns | Single screen                            | Single screen       | Single screen  | Vertical 3-split screen   | Single screen             | Single screen |
|                 | Chameleon (3-color)                      | Chameleon (3-color) | Horizontal 2-split screen                              | Horizontal 3-split screen | Horizontal 2-split screen |               |
|                 |  |                     | Vertical 2-split screen                                | 4-split screen            |                           |               |
|                 |  |                     |  |                           |                           |               |

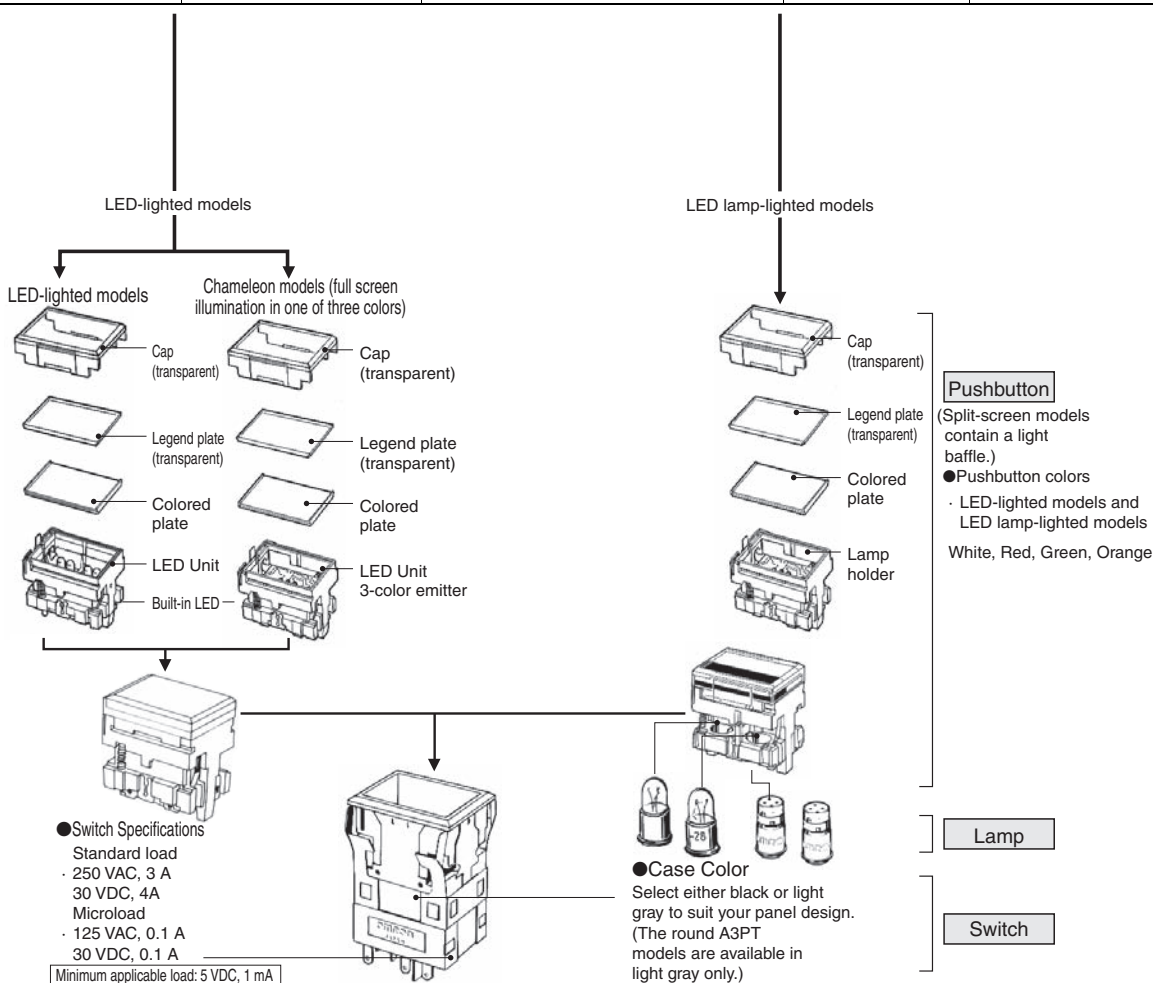

# Nomenclature

## A3P Lighting Method Diagram

The following diagram shows the Switches with the **OMRON** mark facing down.

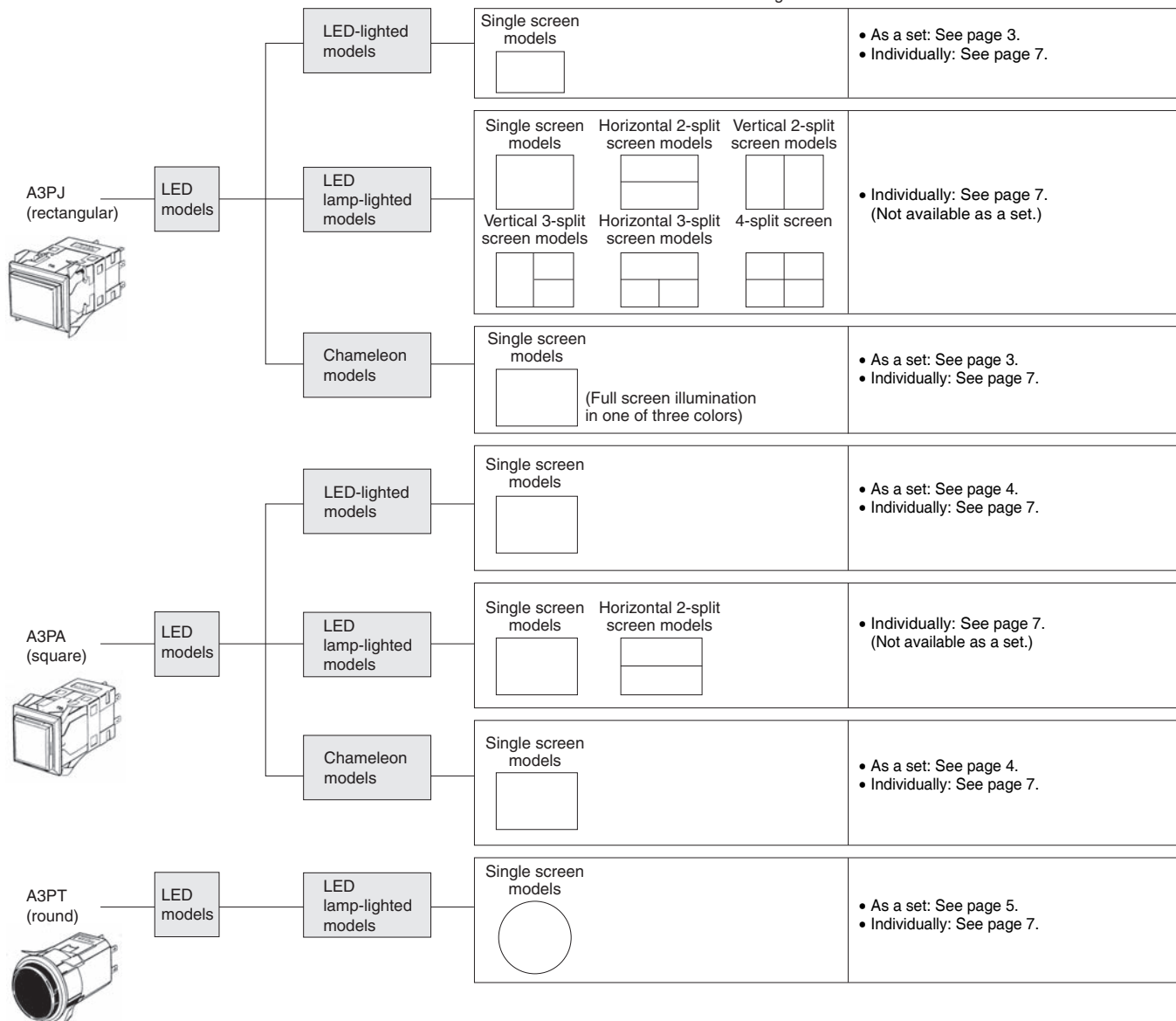

## Dimensions The Dimension shows switch output 2c.

(Unit: mm)

### A3PJ (Rectangular) Models

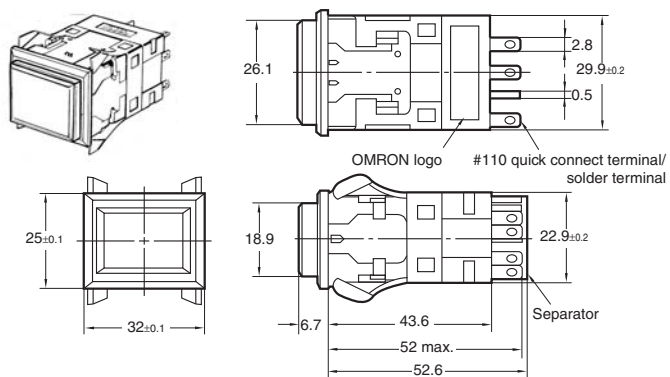

### A3PA (Square) Models

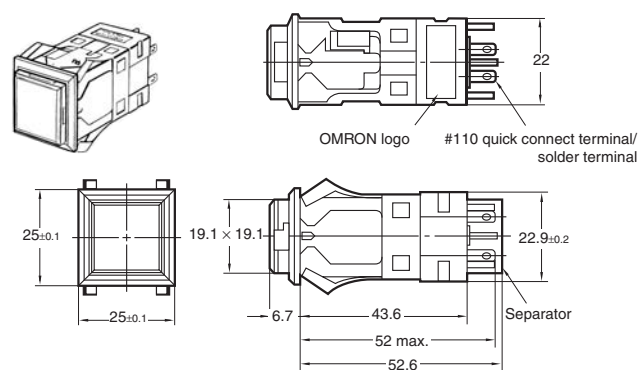

### A3PT (Round) Models

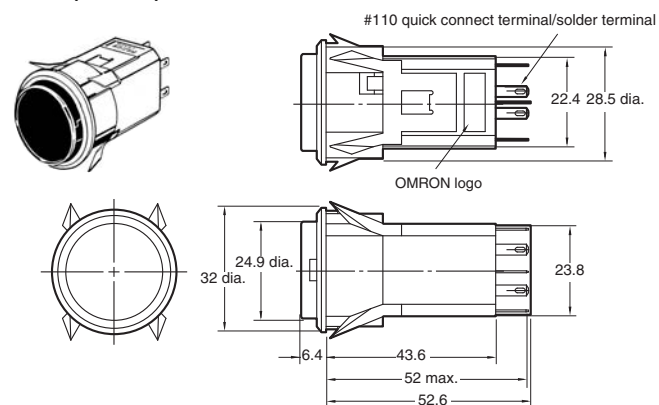

Note: The thickness of tab terminals #110 and solder terminals is 0.5 mm.







## Dimensions

### Terminal connections

#### LED-lighted Models

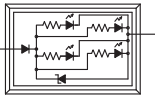
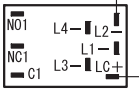
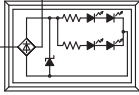
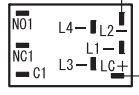
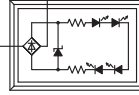
(The terminal arrangement diagram shows switch output 1c. Connections to terminals from the lighting block are the same for switch output 2c.)

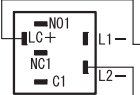
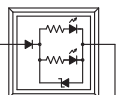
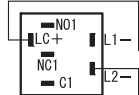
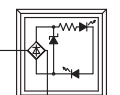
| Rated voltage<br>Model |  | 5 VDC   |   | 12 VAC/VDC   |   | 24 VAC/VDC  |   |
|------------------------|--|---|---|--|---|---|---|
| Screen pattern         |  |   |   |  |   |   |   |
| A3PJ                   | Single screen<br> | Bottom view   | Top view  | Bottom view  | Top view  | Bottom view   | Top view  |
|                        |  |  |  |   |   |  |  |
| A3PA                   | Single screen<br> | Bottom view   | Top view  | Bottom view  | Top view  |   |   |
|                        |  |  |  |  |  |   |   |

## Dimensions

### LED Lamp-lighted Models

(All are shown with the OMRON logo facing down.)

| Output | Model | Rectangular A3PJ models  | Square A3PA models   | Round A3PT models  |
|--------|-------|--|--|--|
| SPDT   |       | <p>Bottom view    Top view</p> <p>Terminal arrangement    Lighting block</p> | <p>Bottom view    Top view</p> <p>Terminal arrangement    Lighting block</p> | <p>Bottom view    Top view</p> <p>Terminal arrangement    Lighting block</p> |
| PPDT   |       | <p>Bottom view    Top view</p> <p>Terminal arrangement    Lighting block</p> | <p>Bottom view    Top view</p> <p>Terminal arrangement    Lighting block</p> | <p>Bottom view    Top view</p> <p>Terminal arrangement    Lighting block</p> |
| 3PDT   |       | <p>Bottom view    Top view</p> <p>Terminal arrangement    Lighting block</p> | ---  | ---  |

### LED Chameleon Models

(The terminal arrangement diagram shows switch output 1c. Connections to terminals from the lighting block are the same for switch output 2c.)

| Rated voltage                     | 24 VDC |
|-----------------------------------|--------|
| <b>Rectangular A3PJ model</b><br> |        |
| <b>Square A3PA model</b><br>      |        |

### Terminal Arrangement and Coloring

#### Chameleon Models

|          |       |     |                        |
|----------|-------|-----|------------------------|
| Wiring   | LC+   | LC+ | LC+                    |
|          | L1-   | L2- | L1- and L2-<br>shorted |
| Coloring | Green | Red | Orange                 |

Dimensions

Panel Cutout (If using a Switch Guard or Seal Cover, refer to the panel cutout diagrams on page 21.)

A3PJ (Rectangular) Models

| Classification       | Mounting design                  | Panel cutout | Remarks |
|----------------------|----------------------------------|--------------|---------|
| Flange mount models  | Individual mounting (Horizontal) |              |         |
|                      | Multiple mounting (Horizontal)   |              |         |
|                      | Individual mounting (Vertical)   |              |         |
|                      | Multiple mounting (Vertical)     |              |         |
| Barrier mount models | Individual mounting (Horizontal) |              |         |
|                      | Multiple mounting (Horizontal)   |              |         |
|                      | Individual mounting (Vertical)   |              |         |
|                      | Multiple mounting (Vertical)     |              |         |

Panel cutout spacing between rows of Units:

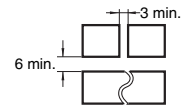

For barrier mount models, refer to Accessories on page 10. Panel cutout spacing between rows of Units: (Dotted line indicates the position of each mounting barrier.)

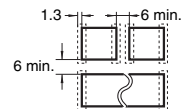

- Note: 1. n: Number of Units  
 2. Recommended panel thickness: 1 to 5 mm  
 3. Mount the panel before mounting the Switch Guard.  
 4. If the panel is to be finished (e.g., coated), make sure that the panel meets the specified dimensions after the coating.

A3PA (Square) Models

| Classification       | Mounting design     | Panel cutout | Remarks |
|----------------------|---------------------|--------------|---------|
| Flange mount models  | Individual mounting |              |         |
|                      | Multiple mounting   |              |         |
| Barrier mount models | Individual mounting |              |         |
|                      | Multiple mounting   |              |         |

Panel cutout spacing between rows of Units:

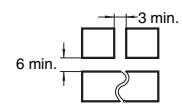

Panel cutout spacing between rows of Units: (Dotted line indicates the position of each mounting barrier.)

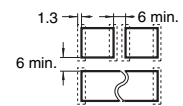

- Note: 1. n: Number of Units  
 2. Recommended panel thickness: 1 to 5 mm  
 3. Mount the panel before mounting the Switch Guard.  
 4. If the panel is to be finished (e.g., coated), make sure that the panel meets the specified dimensions after the coating.

A3PT (Round) Models

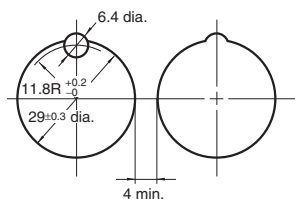

- Note: 1. Recommended panel thickness: 1 to 5 mm  
 2. If the panel is to be finished (e.g., coated), make sure that the panel meets the specified dimensions after the coating.

## Dimensions

### Accessory Mounting Dimensions

#### Legend Plate

#### Rectangular Models

#### A3PJ-5201/-5202

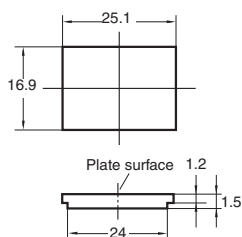

#### Square Models

#### A3PA-5201/-5202

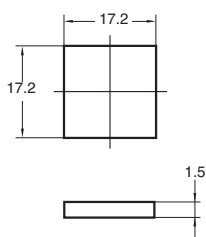

#### Extractor

#### A3PJ-5080

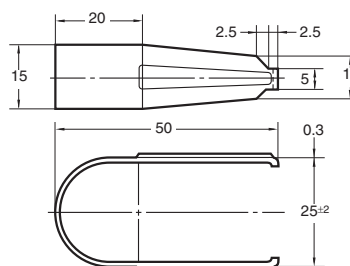

Note: Made from stainless steel.

### Socket-mounting Dimensions

#### Rectangular Models A3PJ (M2PJ)

#### Wire-wrap Terminal A3PJ-4101

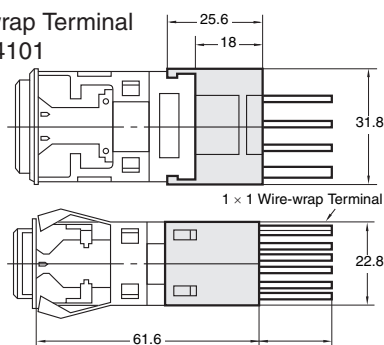

#### PCB Terminal A3PJ-4102

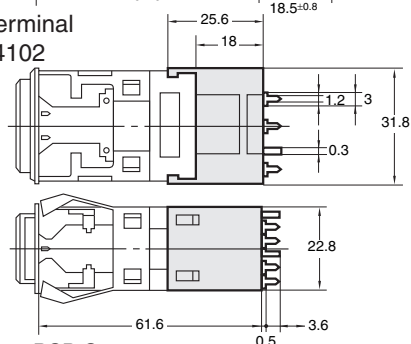

#### PCB Cutout (bottom view)

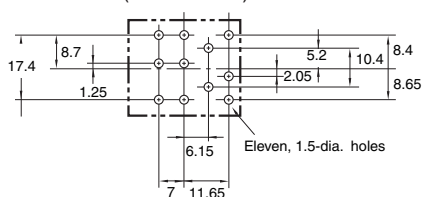

#### Solder Terminal A3PJ-4103

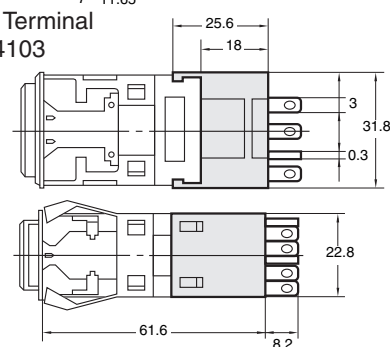

#### Terminal Hole Dimensions

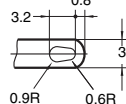

#### Square Models A3PA (M2PA)

#### Wire-wrap Terminal A3PA-4101

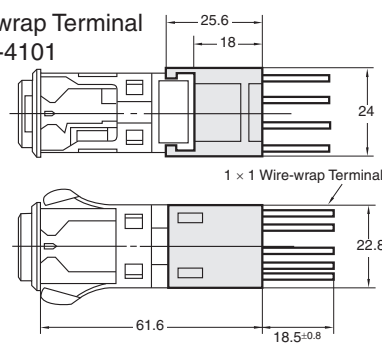

#### PCB Terminal A3PA-4102

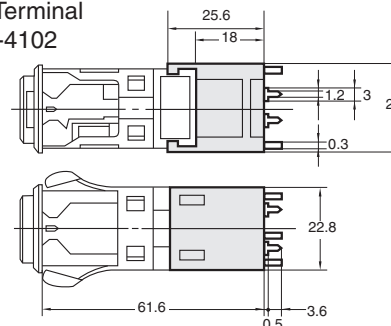

#### PCB Cutout (bottom view)

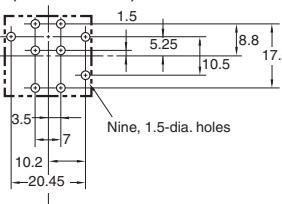

#### Solder Terminal A3PA-4103

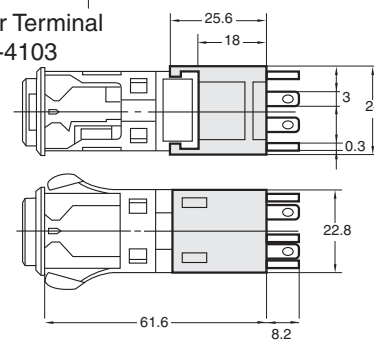

#### Terminal Hole Dimensions

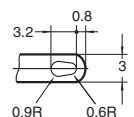

Note: PCB cutout dimensions show the switch mounted to the socket with the OMRON logo facing down.

**Dimensions**

**Switch and Guard Mounting Dimensions**

**Rectangular Models**

**A3PJN-5050 (Horizontal Mounting)**  
**A3PJN-5055 (Vertical Mounting)**

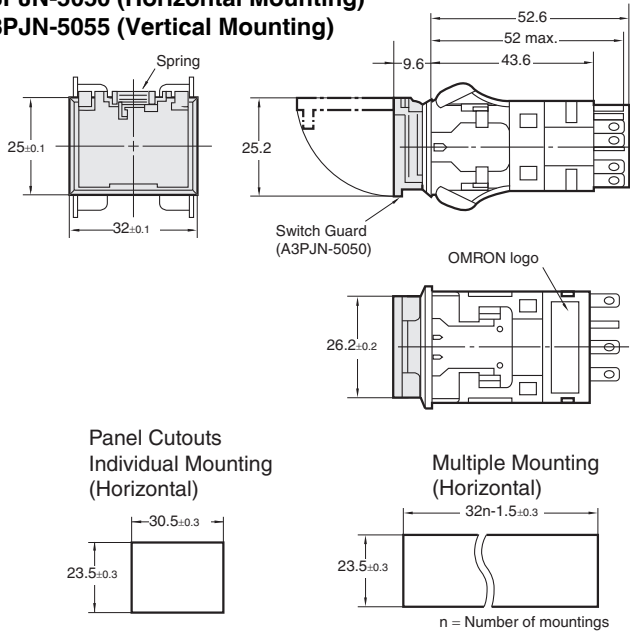

Note: Multiple vertical mounting is not possible.

**Square Models**

**A3PAN-5050 (Horizontal Mounting)**  
**A3PAN-5055 (Vertical Mounting)**

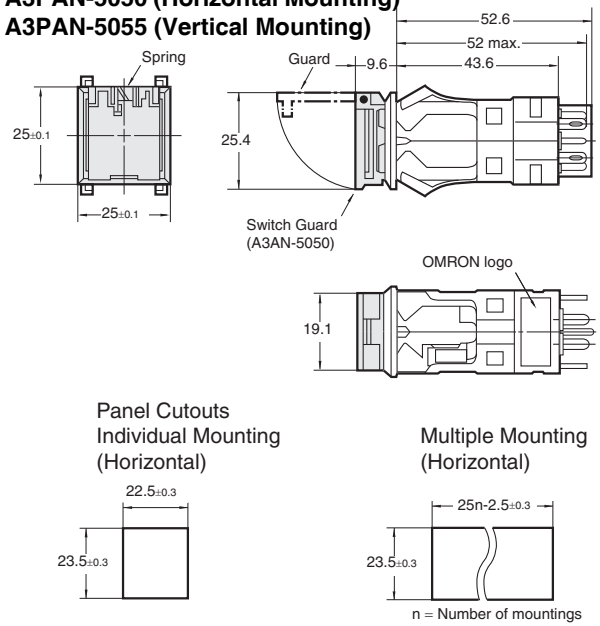

Note: Multiple vertical mounting is not possible.

**Seal Cover Mounting Dimensions**

**Rectangular Models**

**A3PJ-5060**

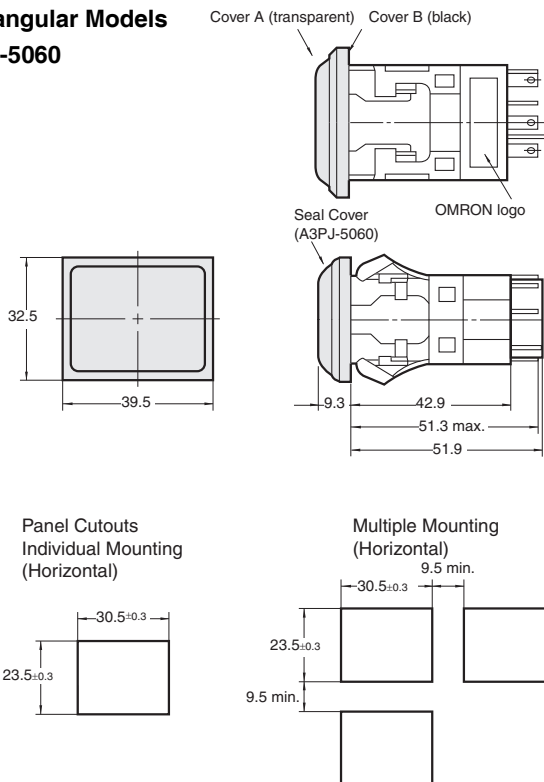

Note: 1. Recommended panel thickness: 1 to 5 mm  
 2. Unless otherwise specified, a tolerance of ± 0.4 mm applies to all dimensions.

**Square Models**

**A3PA-5060**

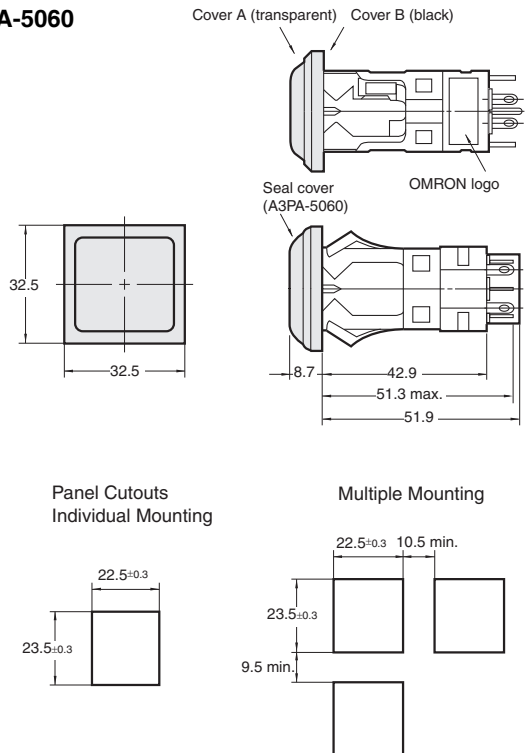

## Safety Precautions

Refer to *Safety Precautions for all Pushbutton Switches/Indicators*.

### Caution

Do not apply a voltage higher than the maximum rated operating voltage between the lamp terminals, as there is a risk that LED will be damaged, and the Pushbutton will be ejected.



### Precautions for Correct Use

1. Always make sure that the power is turned OFF before mounting, removing, or wiring the Switch, or performing maintenance. Electric shock or fire may occur.
2. After wiring the Switch, make sure that there is a suitable isolation distance.

### Wiring

- Solder quickly and correctly at 350°C max and for 3 s or less. Wait for one minute after soldering before exerting any external force on the solder.

### Operating Environment

- Do not use in locations that are subject to dust, oil, or metal filings as these may penetrate the interior of the Switch and cause malfunction.

### LED (for VDC)

- Check the terminal polarity when wiring.
- The rated voltage is shown on the plate on the back of the lighting unit, so be sure to use within the voltage shown.
- An LED current-limiting resistor is built in, so there is no need to mount an external resistor.

### Character Plate (Character Film)

- If preparing the character plate separately, use a heat-resistant film with a thickness of 0.1 to 0.3 mm.

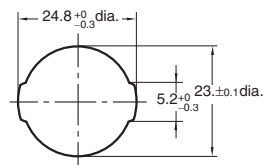
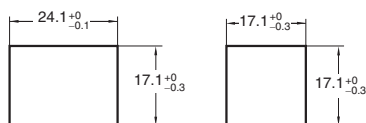

### Using Microloads

- Using a standard load switch when a microload circuit is opened or closed may cause contact failure on the contacts. Use the switch within the operating range. (Refer to the diagram below.) Even when using microload models within the operating range shown below, if inrush current occurs when the contact is opened or closed, it may cause the contact surface to become rough, and so decrease life expectancy. Therefore, insert a contact protection circuit where necessary. The minimum applicable load is the N-level reference value. This value indicates the malfunction reference level for the reliability level of 60% ( $\lambda 60$ ) (conforming to JIS C5003). The equation,  $\lambda 60 = 0.5 \times 10^{-6}/\text{time}$  indicates that the estimated malfunction rate is less than 1/2,000,000 with a reliability level of 60%.

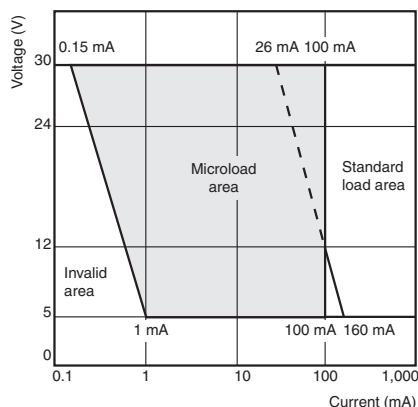

### Others

- If the panel is to be finished (e.g., coated), make sure that the panel meets the specified dimensions after the coating.

## Assembly/Disassembly

### A3PJ/M2PJ (Rectangular Models), A3PA/M2PA (Square Models)

#### Locking/Unlocking Positive Cap Lock Mechanism

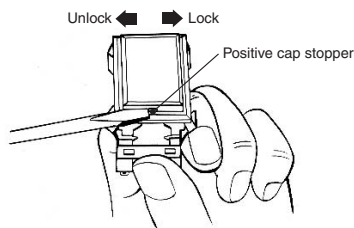

#### Mounting Pushbutton

- Be sure to mount the Pushbutton with the correct orientation. Align the groove on the Pushbutton, the projections in the Switch, and the LED contact piece before pushing the Pushbutton into the Switch.
- When dismantling the Pushbutton, use the Extractor (A3PJ-5080) for easy dismantling.

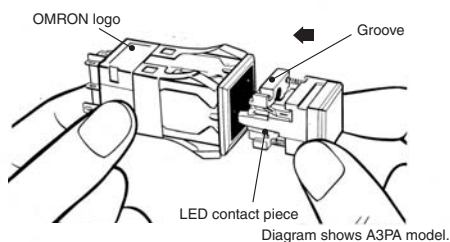

#### Removing/Mounting Cap

Insert the A3PA from the open side into the theft-prevention stopper.

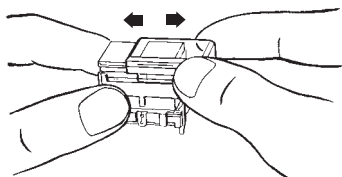

#### Mounting Colored Plate

Place the colored plate on the plunger case with the dull side of the colored plate facing downward.

With A3PJ split-screen models, be sure that the projections on the upper surface of the colored plate face outward. For the A3PA, make sure that the flat plate is facing upwards.

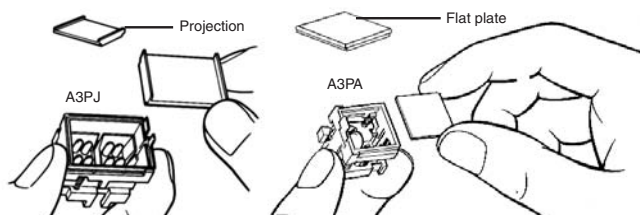

#### Mounting Character Plate (Character Frame) and Legend Plate

Mount the legend plate for the A3PJ under the layered surfaces and mount the cap, as shown below.

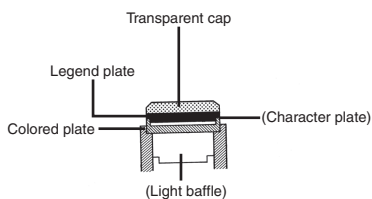

#### Mounting and Replacing LED Lamps

If using a square model with one LED lamp, insert the lamp in the center hole.

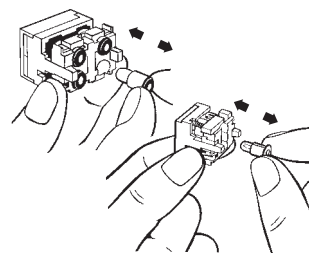

Note: Built-in LEDs cannot be replaced.

#### LED Rated Voltage Display (LED Models Only)

The LED rated voltage is shown between the built-in resistors on the back of the lighting unit. Use within a range of  $\pm 5\%$ .

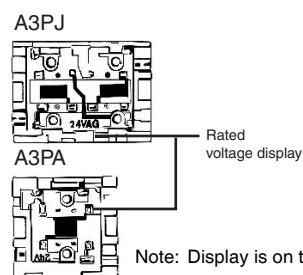

Note: Display is on the back.

#### Mounting Switch onto Panel

- **Individual Mounting and Barrier Mounting**  
When mounting the Switch, push it into the panel cutout from the front of the mounting panel by holding it with the logo mark "OMRON" facing downward.
- **Multiple Barrier Mounting (A3PJ)**  
When mounting a number of Switches in line on the panel, link the Switches with spacing barriers in between, attach mounting barriers at both sides of this block of Switches and, pushing in on the mounting barriers at the side, insert the Switches into the panel cutout together.

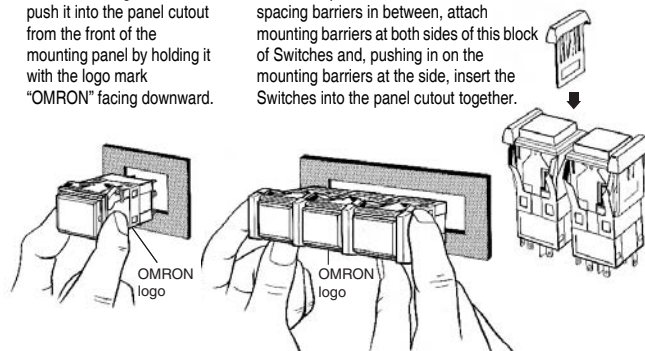

#### Mounting Barriers

Mount each part by pushing it in the direction of the arrow shown in the corresponding illustration below.

Barrier mounting

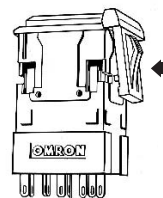

### Mounting Seal Cover

After mounting the seal cover onto the flange of the Switch, push the Switch into the panel cutout.

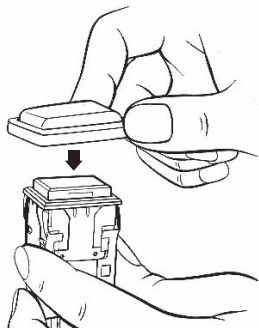

### Inscribing the Legend Plate

- Inscribe the legend plate to a depth of 0.5 mm max.
- The legend plate is made from polycarbonate resin. To coat the legend plate, use an alcohol-based coating such as melamine, phthalic acid, or acrylic.

### Maintenance Lock

1. First, when you insert the transparent lens while pressing the center, the maintenance lock mechanism will be activated, and the Switch will not operate. Lamp replacement and other maintenance can be performed without turning OFF the power supply to devices and equipment. Use an insertion force of 4 kg.

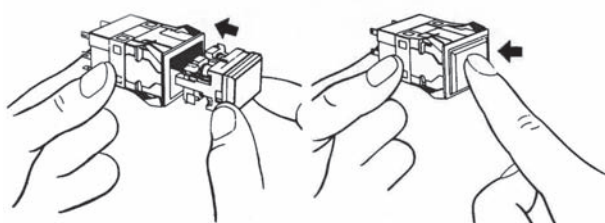

2. Next, when you remove your finger from the Switch, the lock will be released.

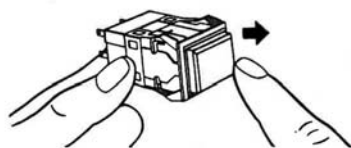

3. The Switch will start to operate when the lighting unit is pressed the second time.

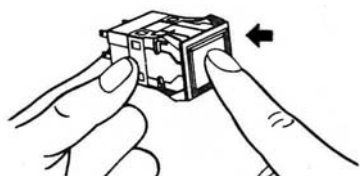



## Terms and Conditions Agreement

### Read and understand this catalog.

Please read and understand this catalog before purchasing the products. Please consult your OMRON representative if you have any questions or comments.

### Warranties.

(a) Exclusive Warranty. Omron's exclusive warranty is that the Products will be free from defects in materials and workmanship for a period of twelve months from the date of sale by Omron (or such other period expressed in writing by Omron). Omron disclaims all other warranties, express or implied.

(b) Limitations. OMRON MAKES NO WARRANTY OR REPRESENTATION, EXPRESS OR IMPLIED, ABOUT NON-INFRINGEMENT, MERCHANTABILITY OR FITNESS FOR A PARTICULAR PURPOSE OF THE PRODUCTS. BUYER ACKNOWLEDGES THAT IT ALONE HAS DETERMINED THAT THE PRODUCTS WILL SUITABLY MEET THE REQUIREMENTS OF THEIR INTENDED USE.

Omron further disclaims all warranties and responsibility of any type for claims or expenses based on infringement by the Products or otherwise of any intellectual property right. (c) Buyer Remedy. Omron's sole obligation hereunder shall be, at Omron's election, to (i) replace (in the form originally shipped with Buyer responsible for labor charges for removal or replacement thereof) the non-complying Product, (ii) repair the non-complying Product, or (iii) repay or credit Buyer an amount equal to the purchase price of the non-complying Product; provided that in no event shall Omron be responsible for warranty, repair, indemnity or any other claims or expenses regarding the Products unless Omron's analysis confirms that the Products were properly handled, stored, installed and maintained and not subject to contamination, abuse, misuse or inappropriate modification. Return of any Products by Buyer must be approved in writing by Omron before shipment. Omron Companies shall not be liable for the suitability or unsuitability or the results from the use of Products in combination with any electrical or electronic components, circuits, system assemblies or any other materials or substances or environments. Any advice, recommendations or information given orally or in writing, are not to be construed as an amendment or addition to the above warranty.

See <http://www.omron.com/global/> or contact your Omron representative for published information.

### Limitation on Liability; Etc.

OMRON COMPANIES SHALL NOT BE LIABLE FOR SPECIAL, INDIRECT, INCIDENTAL, OR CONSEQUENTIAL DAMAGES, LOSS OF PROFITS OR PRODUCTION OR COMMERCIAL LOSS IN ANY WAY CONNECTED WITH THE PRODUCTS, WHETHER SUCH CLAIM IS BASED IN CONTRACT, WARRANTY, NEGLIGENCE OR STRICT LIABILITY.

Further, in no event shall liability of Omron Companies exceed the individual price of the Product on which liability is asserted.

### Suitability of Use.

Omron Companies shall not be responsible for conformity with any standards, codes or regulations which apply to the combination of the Product in the Buyer's application or use of the Product. At Buyer's request, Omron will provide applicable third party certification documents identifying ratings and limitations of use which apply to the Product. This information by itself is not sufficient for a complete determination of the suitability of the Product in combination with the end product, machine, system, or other application or use. Buyer shall be solely responsible for determining appropriateness of the particular Product with respect to Buyer's application, product or system. Buyer shall take application responsibility in all cases.

NEVER USE THE PRODUCT FOR AN APPLICATION INVOLVING SERIOUS RISK TO LIFE OR PROPERTY OR IN LARGE QUANTITIES WITHOUT ENSURING THAT THE SYSTEM AS A WHOLE HAS BEEN DESIGNED TO ADDRESS THE RISKS, AND THAT THE OMRON PRODUCT(S) IS PROPERLY RATED AND INSTALLED FOR THE INTENDED USE WITHIN THE OVERALL EQUIPMENT OR SYSTEM.

### Programmable Products.

Omron Companies shall not be responsible for the user's programming of a programmable Product, or any consequence thereof.

### Performance Data.

Data presented in Omron Company websites, catalogs and other materials is provided as a guide for the user in determining suitability and does not constitute a warranty. It may represent the result of Omron's test conditions, and the user must correlate it to actual application requirements. Actual performance is subject to the Omron's Warranty and Limitations of Liability.

### Change in Specifications.

Product specifications and accessories may be changed at any time based on improvements and other reasons. It is our practice to change part numbers when published ratings or features are changed, or when significant construction changes are made. However, some specifications of the Product may be changed without any notice. When in doubt, special part numbers may be assigned to fix or establish key specifications for your application. Please consult with your Omron's representative at any time to confirm actual specifications of purchased Product.

### Errors and Omissions.

Information presented by Omron Companies has been checked and is believed to be accurate; however, no responsibility is assumed for clerical, typographical or proofreading errors or omissions.

2022.1

In the interest of product improvement, specifications are subject to change without notice.

**OMRON Corporation**  
Industrial Automation Company

<http://www.ia.omron.com/>

(c)Copyright OMRON Corporation 2022 All Right Reserved.

## X-ON Electronics

Largest Supplier of Electrical and Electronic Components

*Click to view similar products for [Lamps category](#):*

*Click to view products by [Omron manufacturer](#):*

Other Similar products are found below :

[5AB](#) [6180](#) [8111](#) [8623](#) [912](#) [120PS](#) [1224](#) [DE603](#) [DW50](#) [IFL-LX2162-16T](#) [C9A](#) [C9A](#) [3015](#) [303](#) [19](#) [PR13](#) [268](#) [GT-NE6H1225T](#)  
[CM5004WW](#) [32-2211T](#) [323](#) [509K](#) [5314N1](#) [5314N2](#) [WWT1-EW10/GRN](#) [4925H1](#) [DW07](#) [10C7DC-120V](#) [1141](#) [MS25231-313](#) [E73](#) [CM2](#)  
[7683EBP](#) [8553](#) [XE135B](#) [WWT2-EW34BLA](#) [6S6/30V](#) [7367](#) [1301910036](#) [7A1H](#) [8630FBBB](#) [85](#) [106](#) [105](#) [BGF717-UV1](#) [1974D](#) [1495](#) [373](#)  
[400](#) [502](#)