

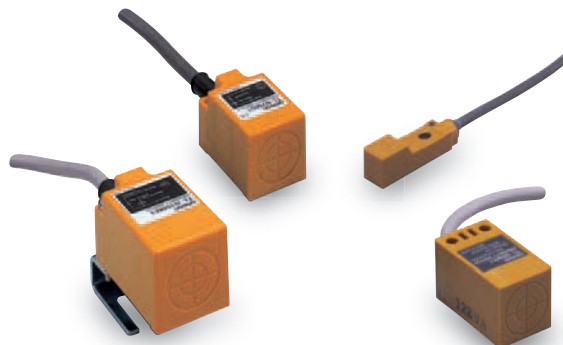

## A Wealth of Models for All Types of Applications

- Easy installation, high-speed pulse generator, high-speed rotation control, and more.
- Direct mounted to metal (-N Models).
- A wealth of models ideal for limit control, counting control, and other applications (-N Models).



Be sure to read *Safety Precautions* on page 9.

For the most recent information on models that have been certified for safety standards, refer to your OMRON website.

## Ordering Information

**Sensors** [Refer to *Dimensions* on page 10.]

### DC 2-Wire Models

Appearance	Sensing distance			Model	
				Operation mode	
				NO	NC
Unshielded 	17 × 17	5 mm		TL-Q5MD1 2M *	TL-Q5MD2 2M *
	25 × 25	7 mm		TL-N7MD1 2M *	TL-N7MD2 2M *
	30 × 30	12 mm		TL-N12MD1 2M *	TL-N12MD2 2M *
	40 × 40	20 mm		TL-N20MD1 2M *	TL-N20MD2 2M *

\* Models with a different frequency are available to prevent mutual interference. The model numbers are TL-N□MD□5 and TL-Q5MD□5 (e.g., TL-N7MD15).

### DC 3-Wire and AC 2-Wire Models

Appearance	Sensing distance			Output configuration	Model	
					Operation mode	
					NO	NC
Unshielded 	8 × 9	2 mm		DC 3-wire, NPN	TL-Q2MC1 2M	—
	17 × 17	5 mm			TL-Q5MC1 2M *	TL-Q5MC2 2M
	25 × 25	5 mm		DC 3-wire, NPN	TL-N5ME1 2M *	TL-N5ME2 2M *
				AC 2-wire	TL-N5MY1 2M *	TL-N5MY2 2M *
	30 × 30	10 mm		DC 3-wire, NPN	TL-N10ME1 2M *	TL-N10ME2 2M *
				AC 2-wire	TL-N10MY1 2M *	TL-N10MY2 2M *
	40 × 40	20 mm		DC 3-wire, NPN	TL-N20ME1 2M *	TL-N20ME2 2M *
				AC 2-wire	TL-N20MY1 2M *	TL-N20MY2 2M *

\* Models with a different frequency are available to prevent mutual interference. The model numbers are TL-□□M□□5 (e.g., TL-N5ME15).

## Accessories (Order Separately)

**Mounting Brackets** A Mounting Bracket is provided with the Sensor depending on the model number. Check the column for the applicable Sensor.  
**[Refer to Dimensions on page 11.]**

Type	Model	Applicable Sensors	
		Provided with these Sensors	Order separately
Mounting Brackets	Y92E-C5	TL-N5ME□, TL-N7MD□	TL-N5MY□
	Y92E-C10	TL-N10ME□, TL-N12MD□	TL-N10MY□
	Y92E-C20	TL-N20ME□, TL-N20MD□	TL-N20MY□
Mounting Brackets for Conduits	Y92E-N5C15	---	TL-N5ME□, TL-N5MY□
	Y92E-N10C15	---	TL-N10ME□, TL-N10MY□

## Ratings and Specifications

### DC 2-Wire Models

Item	Model	TL-Q5MD□	TL-N7MD□	TL-N12MD□	TL-N20MD□
Sensing distance		5 mm ±10%	7 mm ±10%	12 mm ±10%	20 mm ±10%
Set distance		0 to 4 mm	0 to 5.6 mm	0 to 9.6 mm	0 to 16 mm
Differential travel		10% max. of sensing distance			
Detectable object		Ferrous metal (The sensing distance decreases with non-ferrous metal. Refer to <i>Engineering Data</i> on page 5.)			
Standard sensing object		Iron, 18 × 18 × 1 mm	Iron, 30 × 30 × 1 mm	Iron, 40 × 40 × 1 mm	Iron, 50 × 50 × 1 mm
Response frequency *		500 Hz			300 Hz
Power supply voltage (operating voltage range)		12 to 24 VDC (10 to 30 VDC), ripple (p-p): 10% max.			
Leakage current		0.8 mA max.			
Control output	Load current	3 to 100 mA			
	Residual voltage	3.3 V max. (Load current: 100 mA, Cable length: 2 m)			
Indicators		D1 Models: Operation indicator (red), Setting indicator (green) D2 Models: Operation indicator (red)			
Operation mode (with sensing object approaching)		D1 Models: NO D2 Models: NC Refer to the timing charts under <i>I/O Circuit Diagrams</i> on page 7 for details.			
Protection circuits		Load short-circuit protection, Surge suppressor			
Ambient temperature range		Operating/Storage: -25 to 70°C (with no icing or condensation)			
Ambient humidity range		Operating/Storage: 35% to 95% (with no condensation)			
Temperature influence		±10% max. of sensing distance at 23°C in the temperature range of -25 to 70°C			
Voltage influence		±2.5% max. of sensing distance at rated voltage in the rated voltage ±15% range			
Insulation resistance		50 MΩ min. (at 500 VDC) between current-carrying parts and case			
Dielectric strength		1,000 VAC for 1 min between current-carrying parts and case			
Vibration resistance		Destruction: 10 to 55 Hz, 1.5-mm double amplitude for 2 hours each in X, Y, and Z directions			
Shock resistance		Destruction: 500 m/s <sup>2</sup> 3 times each in X, Y, and Z directions	Destruction: 1,000 m/s <sup>2</sup> 10 times each in X, Y, and Z directions		
Degree of protection		IEC 60529 IP67, in-house standards: oil-resistant			
Connection method		Pre-wired Models (Standard cable length: 2 m)			
Weight (packed state)		Approx. 85 g	Approx. 165 g	Approx. 235 g	Approx. 330 g
Materials	Case	Heat-resistant ABS			
	Sensing surface				
Accessories		Instruction manual	Mounting Bracket, Mounting phillips screws (M4 × 25), Instruction manual	Mounting Bracket, Mounting phillips screws (M4 × 30), Instruction manual	Mounting Bracket, Mounting phillips screws (M5 × 40), Instruction manual

\* The response frequency is an average value.

Measurement conditions are as follows: standard sensing object, a distance of twice the standard sensing object, and a set distance of half the sensing distance.

DC 3-Wire Models

Item	Model	TL-Q2MC1	TL-Q5MC□
Sensing distance		2 mm ±15%	5 mm ±10%
Set distance		0 to 1.5 mm	0 to 4 mm
Differential travel		10% max. of sensing distance	
Detectable object		Ferrous metal (The sensing distance decreases with non-ferrous metal. Refer to <i>Engineering Data</i> on page 6.)	
Standard sensing object		Iron, 8 × 8 × 1 mm	Iron, 15 × 15 × 1 mm
Response time		---	2 ms max.
Response frequency *		500 Hz	
Power supply voltage (operating voltage range)		12 to 24 VDC (10 to 30 VDC), ripple (p-p): 10% max.	
Current consumption		15 mA max. at 24 VDC (no-load)	10 mA max. at 24 VDC
Control output	Load current	NPN open collector 100 mA max. at 30 VDC max.	NPN open collector 50 mA max. at 30 VDC max.
	Residual voltage	1 V max. (under load current of 100 mA with cable length of 2 m)	1 V max. (under load current of 50 mA with cable length of 2 m)
Indicators		Detection indicator (red)	
Operation mode (with sensing object approaching)		NO	C1 Models: NO C2 Models: NC
		Refer to the timing charts under <i>DC 3-Wire Models</i> on page 8 for details.	
Protection circuits		Reverse polarity protection, Surge suppressor	
Ambient temperature range		Operating/Storage: -10 to 60°C (with no icing or condensation)	Operating/Storage: -25 to 70°C (with no icing or condensation)
Ambient humidity range		Operating/Storage: 35% to 95% (with no condensation)	
Temperature influence		±10% max. of sensing distance at 23°C in the temperature range of -10 to 60°C	±20% max. of sensing distance at 23°C in the temperature range of -25 to 70°C
Voltage influence		±2.5% max. of sensing distance at rated voltage in rated voltage ±10% range	
Insulation resistance		50 MΩ min. (at 500 VDC) between current-carrying parts and case	5 MΩ min. (at 500 VDC) between current-carrying parts and case
Dielectric strength		1,000 VAC for 1 min between current-carrying parts and case	500 VAC, 50/60 Hz for 1 min between current-carrying parts and case
Vibration resistance		Destruction: 10 to 55 Hz, 1.5-mm double amplitude for 2 hours each in X, Y, and Z directions	
Shock resistance		Destruction: 1,000 m/s <sup>2</sup> 10 times each in X, Y, and Z directions	Destruction: 200 m/s <sup>2</sup> 10 times each in X, Y, and Z directions
Degree of protection		IEC 60529 IP67, in-house standards: oil-resistant	IEC IP67
Connection method		Pre-wired Models (Standard cable length: 2 m)	
Weight (packed state)		Approx. 60 g	Approx. 90 g
Materials	Case	Heat-resistant ABS	
	Sensing surface		
Accessories		Instruction manual	---

\* The response frequency is an average value. Measurement conditions are as follows: standard sensing object, a distance of twice the standard sensing object, and a set distance of half the sensing distance.

Item	Model	TL-N5ME□, TL-N5MY□	TL-N10ME□, TL-N10MY□	TL-N20ME□, TL-N20MY□
Sensing distance		5 mm ±10%	10 mm ±10%	20 mm ±10%
Set distance		0 to 4 mm	0 to 8 mm	0 to 16 mm
Differential travel		15% max. of sensing distance		
Detectable object		Ferrous metal (The sensing distance decreases with non-ferrous metal. Refer to <i>Engineering Data</i> on pages 6 and 7.)		
Standard sensing object		Iron, 30 × 30 × 1 mm	Iron, 40 × 40 × 1 mm	Iron, 50 × 50 × 1 mm
Response frequency *1		E Models: 500 Hz Y Models: 10 Hz		E Models: 40 Hz Y Models: 10 Hz
Power supply voltage *2 (operating voltage range)		E Models: 12 to 24 VDC (10 to 30 VDC), ripple (p-p): 10% max. Y Models: 100 to 220 VAC (90 to 250 VAC), 50/60 Hz		
Current consumption		E Models: 8 mA max. at 12 VDC, 15 mA max. at 24 VDC		
Leakage current		Y Models: Refer to <i>Engineering Data</i> on page 5.		
Control output	Load current	E Models: 100 mA max. at 12 VDC, 200 mA max. at 24 VDC Y Models: 10 to 200 mA		
	Residual voltage	E Models: 1 V max. (load current: 200 mA) Y Models: Refer to <i>Engineering Data</i> on page 5.		
Indicators		E Models: Detection indicator (red) Y Models: Operation indicator (red)		
Operation mode (with sensing object approaching)		E1/Y1 Models: NO E2/Y2 Models: NC Refer to the timing charts under <i>I/O Circuit Diagrams</i> on page 8 for details.		
Protection circuits		E Models: Reverse polarity protection, Surge suppressor Y Models: Surge suppressor		
Ambient temperature range		Operating/Storage: -25 to 70°C (with no icing or condensation)		
Ambient humidity range		Operating/Storage: 35% to 95% (with no condensation)		
Temperature influence		±10% max. of sensing distance at 23°C in the temperature range of -25 to 70°C		
Voltage influence		E Models: ±2.5% max. of sensing distance at rated voltage in rated voltage ±10% range Y Models: ±1% max. of sensing distance at rated voltage in rated voltage ±10% range		
Insulation resistance		50 MΩ min. (at 500 VDC) between current-carrying parts and case		
Dielectric strength		E Models: 1,000 VAC, 50/60 Hz for 1 min between current-carrying parts and case Y Models: 2,000 VAC, 50/60 Hz for 1 min between current-carrying parts and case		
Vibration resistance		Destruction: 10 to 55 Hz, 1.5-mm double amplitude for 2 hours each in X, Y, and Z directions		
Shock resistance		Destruction: 500 m/s <sup>2</sup> 10 times each in X, Y, and Z directions		
Degree of protection		IEC 60529 IP67, in-house standards: oil-resistant		
Connection method		Pre-wired Models (Standard cable length: 2 m)		
Weight (packed state)		Approx. 190 g	Approx. 240 g	Approx. 340 g
Materials	Case	Heat-resistant ABS		
	Sensing surface			
Accessories		E Models: Mounting Bracket, Mounting phillips screws (M4 × 25), Instruction manual Y Models: Instruction manual	E Models: Mounting Bracket, Mounting phillips screws (M4 × 30), Instruction manual Y Models: Instruction manual	E Models: Mounting Bracket, Mounting phillips screws (M5 × 40), Instruction manual Y Models: Instruction manual

\*1. The response frequency is an average value. Measurement conditions are as follows: standard sensing object, a distance of twice the standard sensing object, and a set distance of half the sensing distance.

\*2. E Models (DC switching models): A full-wave rectification power supply of 24 VDC ±10% (average value) can be used.

## Engineering Data (Reference Value)

### Sensing Area

TL-Q2MC1

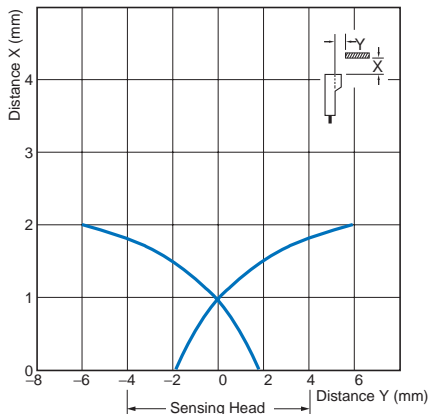

TL-Q5M□□

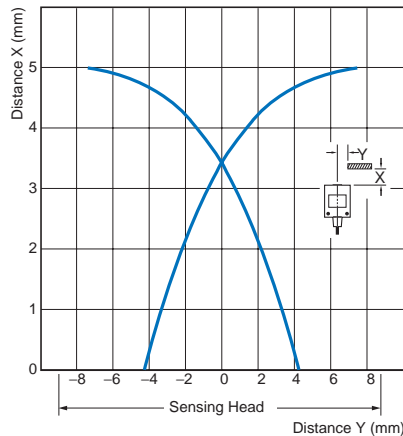

TL-N□ME□  
TL-N□MY□

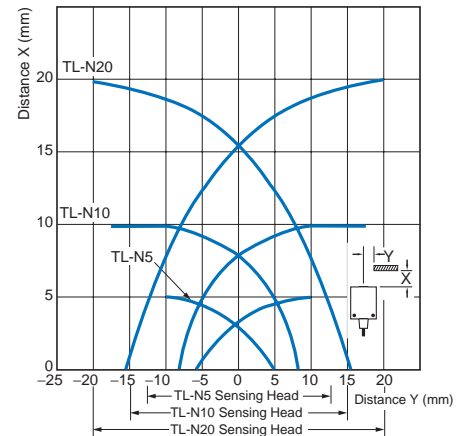

TL-N□MD□

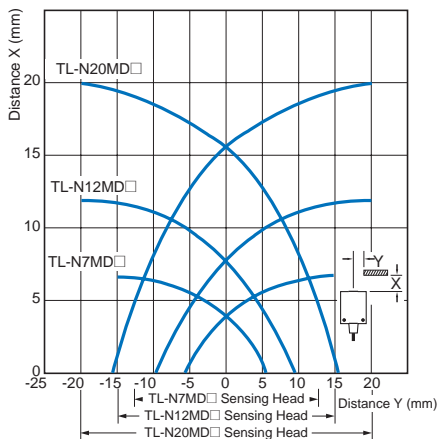

### Leakage Current

TL-N□MY

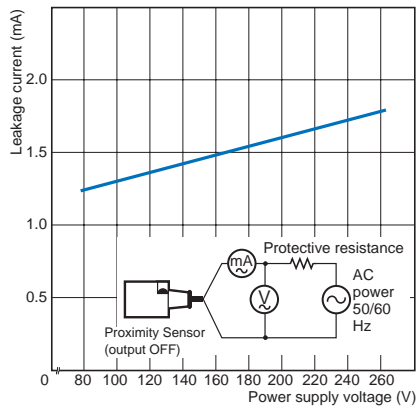

### Residual Output Voltage

TL-N□MD

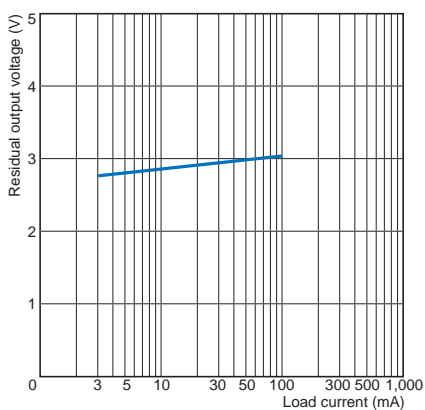

TL-N□MY at 100 VAC

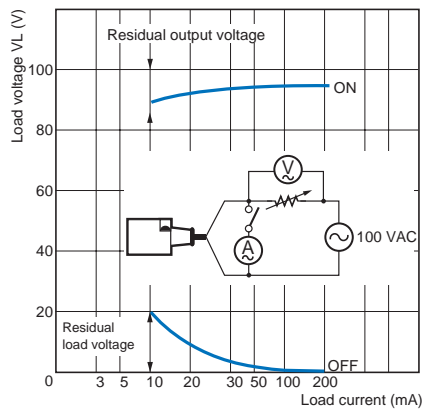

TL-N□MY at 200 VAC

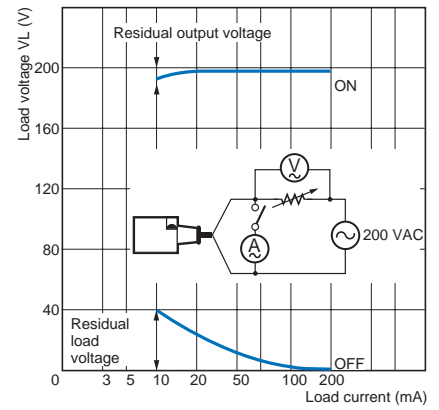

Sensing Object Size vs. Sensing Distance

TL-Q5MC

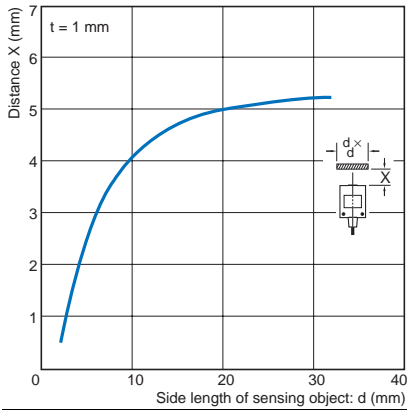

Influence of Sensing Object Size and Material

TL-Q2MC1

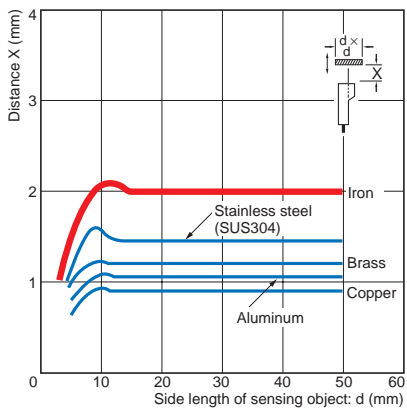

TL-Q5M

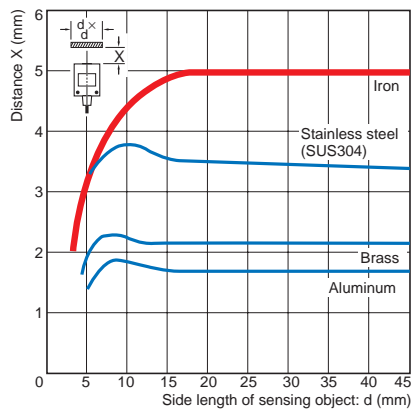

TL-N5

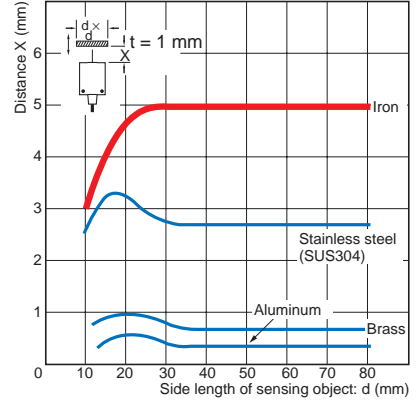

TL-N7MD

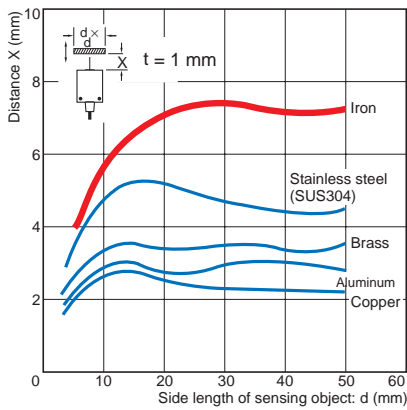

TL-N12MD

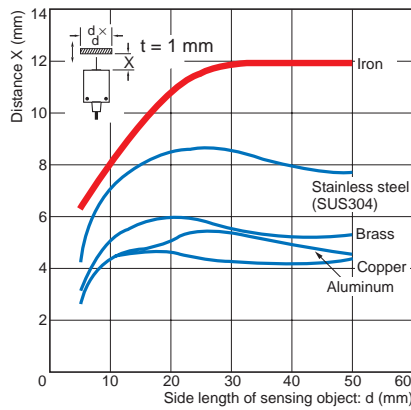

TL-N20MD

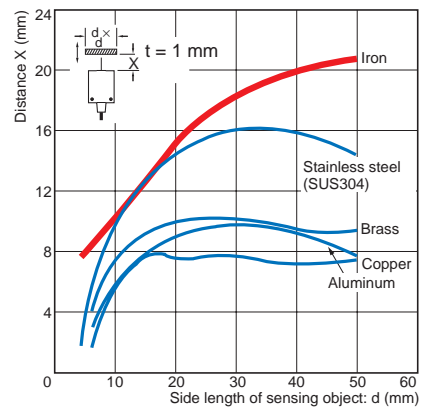

TL-N10□

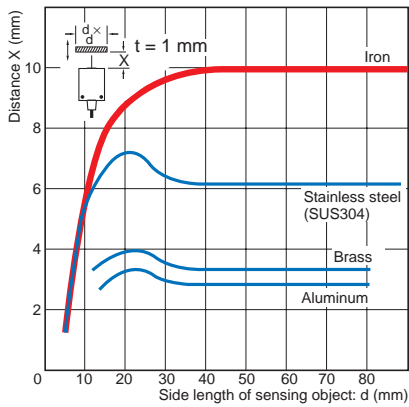

TL-N20□

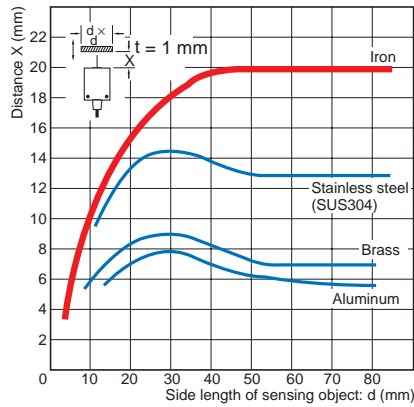

I/O Circuit Diagrams



DC 2-Wire Models

Operation mode	Model	Timing chart	Output circuit
NO	TL-Q5MD1 TL-N7MD1 TL-N12MD1 TL-N20MD1	<p>Non-sensing area    Unstable sensing area    Stable sensing area</p> <p>Sensing object</p> <p>(%)    100    80 (TYP)    0</p> <p>Rated sensing distance</p> <p>ON Setting indicator (green) OFF</p> <p>ON Operation indicator (red) OFF</p> <p>ON Control output OFF</p>	<p>Proximity Sensor main circuit</p> <p>Brown Load +V</p> <p>Blue 0V</p>
NC	TL-Q5MD2 TL-N7MD2 TL-N12MD2 TL-N20MD2	<p>Non-sensing area    Sensing area</p> <p>Sensing object</p> <p>(%)    100    0</p> <p>Rated sensing distance</p> <p>ON Operation indicator (red) OFF</p> <p>ON Control output OFF</p>	<p>Note: The load can be connected to either the +V or 0 V side.</p>

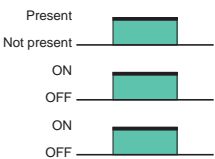
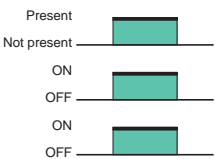
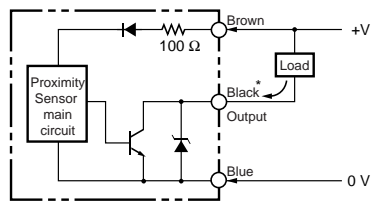
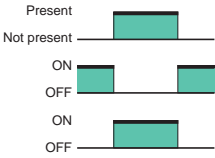
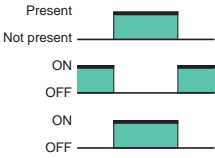
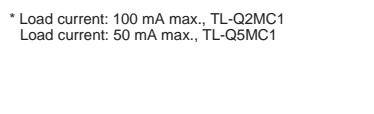
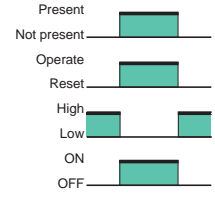
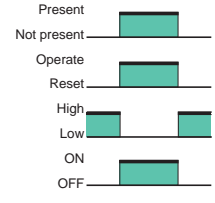
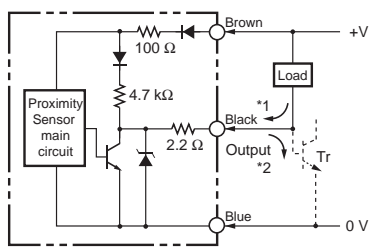
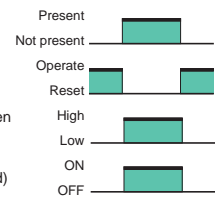
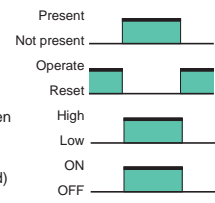
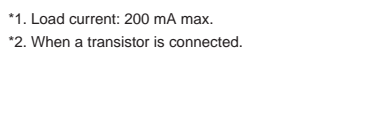
DC 3-Wire Models

Operation mode	Model	Timing chart	Output circuit
NO	TL-Q2MC1 TL-Q5MC1	<p>Sensing object</p> <p>Present </p> <p>Not present </p> <p>Output transistor (load)</p> <p>ON</p> <p>OFF</p> <p>Detection indicator (red)</p> <p>ON</p> <p>OFF</p>	 <p>* Load current: 100 mA max., TL-Q2MC1 Load current: 50 mA max., TL-Q5MC1</p>
NC	TL-Q5MC2	<p>Sensing object</p> <p>Present </p> <p>Not present </p> <p>Output transistor (load)</p> <p>ON</p> <p>OFF</p> <p>Detection indicator (red)</p> <p>ON</p> <p>OFF</p>	
NO	TL-N5ME1 TL-N10ME1 TL-N20ME1	<p>Sensing object</p> <p>Present </p> <p>Not present </p> <p>Load (between brown and black leads)</p> <p>Operate</p> <p>Reset</p> <p>Output voltage (between black and blue leads)</p> <p>High</p> <p>Low</p> <p>Detection indicator (red)</p> <p>ON</p> <p>OFF</p>	 <p>*1. Load current: 200 mA max. *2. When a transistor is connected.</p>
NC	TL-N5ME2 TL-N10ME2 TL-N20ME2	<p>Sensing object</p> <p>Present </p> <p>Not present </p> <p>Load (between brown and black leads)</p> <p>Operate</p> <p>Reset</p> <p>Output voltage (between black and blue leads)</p> <p>High</p> <p>Low</p> <p>Detection indicator (red)</p> <p>ON</p> <p>OFF</p>	

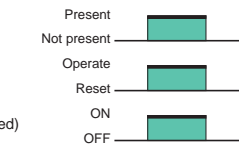
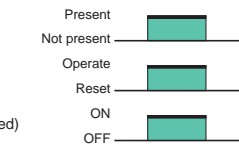
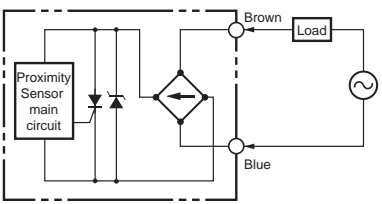
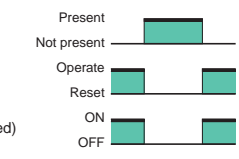
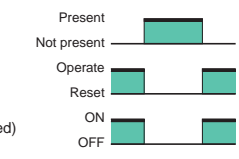
AC 2-Wire Models

Operation mode	Model	Timing chart	Output circuit
NO	TL-N5MY1 TL-N10MY1 TL-N20MY1	<p>Sensing object</p> <p>Present </p> <p>Not present </p> <p>Load</p> <p>Operate</p> <p>Reset</p> <p>Operation indicator (red)</p> <p>ON</p> <p>OFF</p>	
NC	TL-N5MY2 TL-N10MY2 TL-N20MY2	<p>Sensing object</p> <p>Present </p> <p>Not present </p> <p>Load</p> <p>Operate</p> <p>Reset</p> <p>Operation indicator (red)</p> <p>ON</p> <p>OFF</p>	



## Safety Precautions

Refer to *Warranty and Limitations of Liability*.

### ⚠ WARNING

This product is not designed or rated for ensuring safety of persons either directly or indirectly. Do not use it for such purposes.



- Do not short-circuit the load, otherwise the Sensor may be damaged.
- Do not supply power to the Sensor with no load, otherwise the Sensor may be damaged.  
Applicable Models: AC 2-Wire Models



### Precautions for Correct Use

Do not use this product under ambient conditions that exceed the ratings.

#### ● Design

#### Influence of Surrounding Metal

When mounting the Sensor within a metal panel, ensure that the clearances given in the following table are maintained. Failure to maintain these distances may cause deterioration in the performance of the Sensor.

#### Rectangular Models TL-N\*2

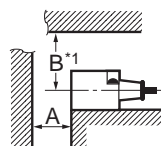

#### TL-Q

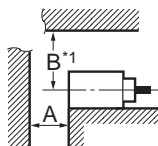

#### Influence of Surrounding Metal (Unit: mm)

Model	Distance	A	B *1
TL-Q5M□□		20	20
TL-N7MD□		40	35
TL-N12MD□		50	40
TL-N20MD□		70	60
TL-N5ME□, TL-N5MY□		20	23
TL-N10ME□, TL-N10MY□		40	30
TL-N20ME□, TL-N20MY□		80	45

\*1. The B dimension applies to the top, right-side, and left-side surfaces.

\*2. The values for A or B for the TL-N apply when there is metal on only one side of the sensor. If there is metal on two or more sides of the sensor, the value must be multiplied by two or more.

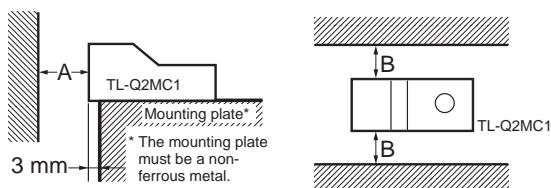

#### Influence of Surrounding Metal (Unit: mm)

Model	Distance	A	B
TL-Q2MC1		12	3

#### ● Mounting

When tightening the mounting screws, do not exceed the torque in the following table.

Model	Torque
TL-Q2MC1	0.59 N·m
TL-Q5M□□	
TL-N□M□□	0.9 to 1.5 N·m

#### Mutual Interference

When installing Sensors face-to-face or side-by-side, ensure that the minimum distances given in the following table are maintained.

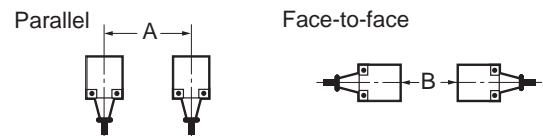

#### Mutual Interference (Unit: mm)

Model	Distance	A *	B *
TL-Q5MC□		60 (17)	120 (60)
TL-Q5MD□		60 (30)	120 (80)
TL-N7MD□		100 (50)	120 (60)
TL-N12MD□		120 (60)	200 (100)
TL-N20MD□		200 (100)	200 (100)
TL-N5ME□		80 (40)	80 (40)
TL-N5MY□		80 (40)	90 (40)
TL-N10ME□, TL-N10MY□		120 (60)	120 (60)
TL-N20ME□, TL-N20MY□		200 (100)	120 (60)

\* Values in parentheses apply to Sensors operating at different frequencies.

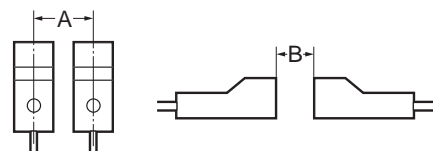

#### Mutual Interference (Unit: mm)

Model	Distance	A *	B *
TL-Q2MC1		30 (8)	90 (45)

\* Values in parentheses apply to Sensors operating at different frequencies.

## Dimensions

### Sensors

#### TL-Q2MC1

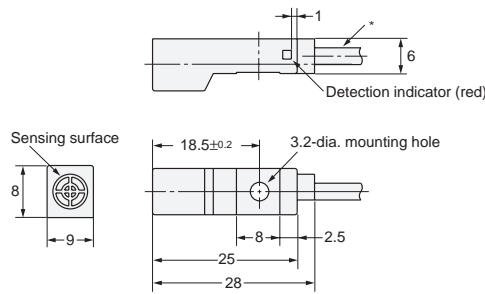
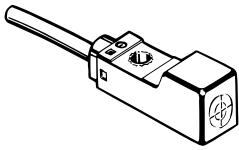

\* 2.9-dia. vinyl-insulated round cable with 3 conductors (Conductor cross section: 0.15 mm<sup>2</sup>, Insulator diameter: 0.9 mm), Standard length: 2 m

#### TL-Q5M□□

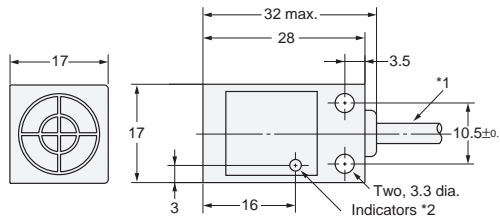
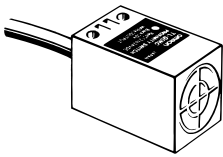

#### Mounting Hole Dimensions

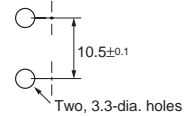

- \*1. C Models: 4-dia. vinyl-insulated round cable with 3 conductors (Conductor cross section: 0.2 mm<sup>2</sup>, Insulator diameter: 1.2 mm), Standard length: 2 m
- D Models: 4-dia. vinyl-insulated round cable with 2 conductors (Conductor cross section: 0.3 mm<sup>2</sup>, Insulator diameter: 1.3 mm), Standard length: 2 m
- \*2. C Models: Detection indicator (red)
- D Models: Operation indicator (red), Setting indicator (green)

#### TL-N7MD□, TL-N5ME□

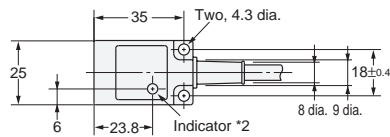
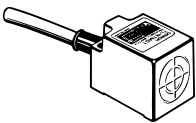

#### Mounting Hole Dimensions

Two, 4.5-dia. or M4 holes

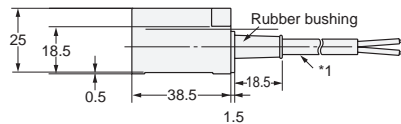
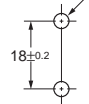

- \*1. D Models: 6-dia. vinyl-insulated round cable with 2 conductors (Conductor cross section: 0.5 mm<sup>2</sup>, Insulator diameter: 1.9 mm), Standard length: 2 m
- E Models: 6-dia. vinyl-insulated round cable with 3 conductors (Conductor cross section: 0.5 mm<sup>2</sup>, Insulator diameter: 1.9 mm), Standard length: 2 m
- \*2. D1 Models: Operation indicator (red), Setting indicator (green)
- D2 Models: Operation indicator (red)
- E Models: Detection indicator (red)

#### TL-N5MY□

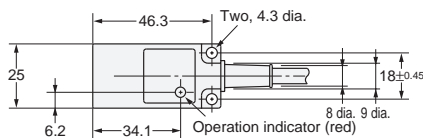
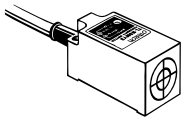

#### Mounting Hole Dimensions

Two, 4.5-dia. or M4 holes

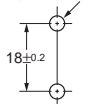

\* 6-dia. vinyl-insulated round cable with 2 conductors (Conductor cross section: 0.5 mm<sup>2</sup>, Insulator diameter: 1.9 mm), Standard length: 2 m

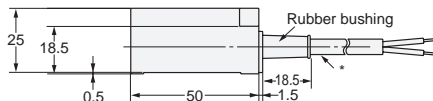

#### TL-N12MD□, TL-N10ME□, TL-N10MY□

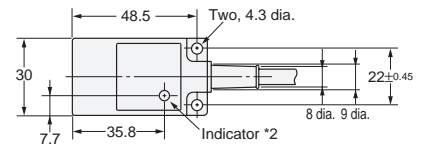
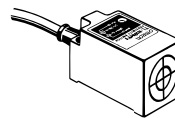

#### Mounting Hole Dimensions

Two, 4.5-dia. or M4 holes

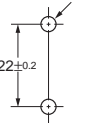

\*1. D/Y Models: 6-dia. vinyl-insulated round cable with 2 conductors (Conductor cross section: 0.5 mm<sup>2</sup>, Insulator diameter: 1.9 mm), Standard length: 2 m

E Models: 6-dia. vinyl-insulated round cable with 3 conductors (Conductor cross section: 0.5 mm<sup>2</sup>, Insulator diameter: 1.9 mm), Standard length: 2 m

\*2. D1 Models: Operation indicator (red) and Setting indicator (green)

D2 Models: Operation indicator (red)

E Models: Detection indicator (red)

Y Models: Operation indicator (red)

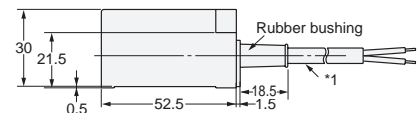

## TL-N20MD□, TL-N20ME□, TL-N20MY□

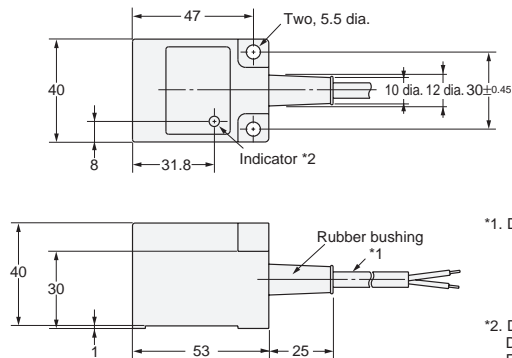
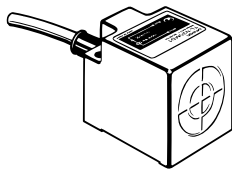

### Mounting Hole Dimensions

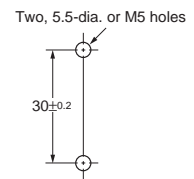

- \*1. D/Y Models: 6-dia. vinyl-insulated round cable with 2 conductors (Conductor cross section: 0.5 mm<sup>2</sup>, Insulator diameter: 1.9 mm), Standard length: 2 m  
E Models: 6-dia. vinyl-insulated round cable with 3 conductors (Conductor cross section: 0.5 mm<sup>2</sup>, Insulator diameter: 1.9 mm), Standard length: 2 m
- \*2. D1 Models: Operation indicator (red) and Setting indicator (green)  
D2 Models: Operation indicator (red)  
E Models: Detection indicator (red)  
Y Models: Operation indicator (red)

## Accessories (Order Separately)

### Mounting Bracket

#### Y92E-C5

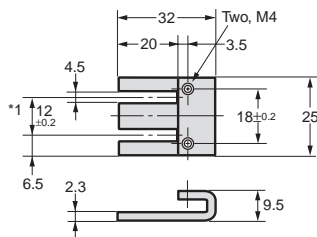

Applicable Models: TL-N5ME□ \*2  
Applicable Models: TL-N5MY□  
Applicable Models: TL-N7MD□ \*2  
Material: Mounting Bracket: Zinc-plated iron  
Mounting phillips Screws: Nickel-plated iron

#### Y92E-C10

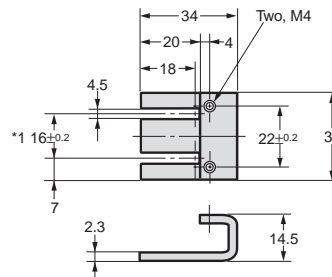

Applicable Models: TL-N10ME□ \*2  
Applicable Models: TL-N10MY□  
Applicable Models: TL-N12MD□ \*2  
Material: Mounting Bracket: Zinc-plated iron  
Mounting phillips Screws: Nickel-plated iron

#### Y92E-C20

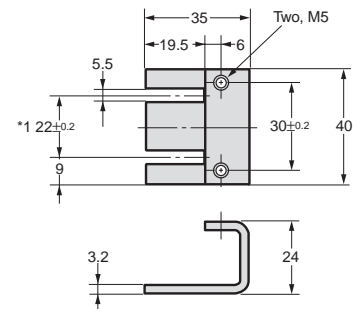

Applicable Models: TL-N20ME□ \*2  
Applicable Models: TL-N20MY□  
Applicable Models: TL-N20MD□ \*2  
Material: Mounting Bracket: Zinc-plated iron  
Mounting phillips Screws: Nickel-plated iron

\*1. These are the mounting dimensions of the base of the Mounting Bracket.

\*2. Provided with the product.

### Mounting Brackets for Wiring Conduit Use (Sold Separately)

#### Y92E-N5C15

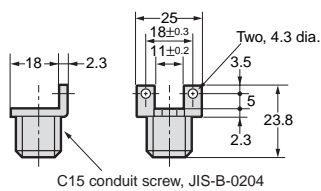

C15 conduit screw, JIS-B-0204  
Applicable Models: TL-N5ME□  
Applicable Models: TL-N5MY□  
Applicable Models: TL-N7MD□  
Material: Zinc-plated iron

#### Y92E-N10C15

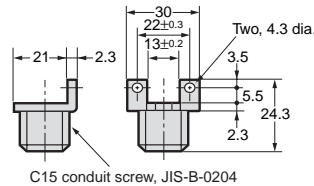

C15 conduit screw, JIS-B-0204  
Applicable Models: TL-N10ME□  
Applicable Models: TL-N10MY□  
Applicable Models: TL-N12MD□  
Material: Zinc-plated iron

## Read and Understand This Catalog

Please read and understand this catalog before purchasing the products. Please consult your OMRON representative if you have any questions or comments.

## Warranty and Limitations of Liability

### WARRANTY

OMRON's exclusive warranty is that the products are free from defects in materials and workmanship for a period of one year (or other period if specified) from date of sale by OMRON.

OMRON MAKES NO WARRANTY OR REPRESENTATION, EXPRESS OR IMPLIED, REGARDING NON-INFRINGEMENT, MERCHANTABILITY, OR FITNESS FOR PARTICULAR PURPOSE OF THE PRODUCTS. ANY BUYER OR USER ACKNOWLEDGES THAT THE BUYER OR USER ALONE HAS DETERMINED THAT THE PRODUCTS WILL SUITABLY MEET THE REQUIREMENTS OF THEIR INTENDED USE. OMRON DISCLAIMS ALL OTHER WARRANTIES, EXPRESS OR IMPLIED.

### LIMITATIONS OF LIABILITY

OMRON SHALL NOT BE RESPONSIBLE FOR SPECIAL, INDIRECT, OR CONSEQUENTIAL DAMAGES, LOSS OF PROFITS OR COMMERCIAL LOSS IN ANY WAY CONNECTED WITH THE PRODUCTS, WHETHER SUCH CLAIM IS BASED ON CONTRACT, WARRANTY, NEGLIGENCE, OR STRICT LIABILITY.

In no event shall the responsibility of OMRON for any act exceed the individual price of the product on which liability is asserted.

IN NO EVENT SHALL OMRON BE RESPONSIBLE FOR WARRANTY, REPAIR, OR OTHER CLAIMS REGARDING THE PRODUCTS UNLESS OMRON'S ANALYSIS CONFIRMS THAT THE PRODUCTS WERE PROPERLY HANDLED, STORED, INSTALLED, AND MAINTAINED AND NOT SUBJECT TO CONTAMINATION, ABUSE, MISUSE, OR INAPPROPRIATE MODIFICATION OR REPAIR.

## Application Considerations

### SUITABILITY FOR USE

OMRON shall not be responsible for conformity with any standards, codes, or regulations that apply to the combination of products in the customer's application or use of the products.

At the customer's request, OMRON will provide applicable third party certification documents identifying ratings and limitations of use that apply to the products. This information by itself is not sufficient for a complete determination of the suitability of the products in combination with the end product, machine, system, or other application or use.

The following are some examples of applications for which particular attention must be given. This is not intended to be an exhaustive list of all possible uses of the products, nor is it intended to imply that the uses listed may be suitable for the products:

- Outdoor use, uses involving potential chemical contamination or electrical interference, or conditions or uses not described in this catalog.
- Nuclear energy control systems, combustion systems, railroad systems, aviation systems, medical equipment, amusement machines, vehicles, safety equipment, and installations subject to separate industry or government regulations.
- Systems, machines, and equipment that could present a risk to life or property.

Please know and observe all prohibitions of use applicable to the products.

NEVER USE THE PRODUCTS FOR AN APPLICATION INVOLVING SERIOUS RISK TO LIFE OR PROPERTY WITHOUT ENSURING THAT THE SYSTEM AS A WHOLE HAS BEEN DESIGNED TO ADDRESS THE RISKS, AND THAT THE OMRON PRODUCTS ARE PROPERLY RATED AND INSTALLED FOR THE INTENDED USE WITHIN THE OVERALL EQUIPMENT OR SYSTEM.

### PROGRAMMABLE PRODUCTS

OMRON shall not be responsible for the user's programming of a programmable product, or any consequence thereof.

## Disclaimers

### CHANGE IN SPECIFICATIONS

Product specifications and accessories may be changed at any time based on improvements and other reasons.

It is our practice to change model numbers when published ratings or features are changed, or when significant construction changes are made. However, some specifications of the products may be changed without any notice. When in doubt, special model numbers may be assigned to fix or establish key specifications for your application on your request. Please consult with your OMRON representative at any time to confirm actual specifications of purchased products.

### DIMENSIONS AND WEIGHTS

Dimensions and weights are nominal and are not to be used for manufacturing purposes, even when tolerances are shown.

### PERFORMANCE DATA

Performance data given in this catalog is provided as a guide for the user in determining suitability and does not constitute a warranty. It may represent the result of OMRON's test conditions, and the users must correlate it to actual application requirements. Actual performance is subject to the OMRON Warranty and Limitations of Liability.

### ERRORS AND OMISSIONS

The information in this document has been carefully checked and is believed to be accurate; however, no responsibility is assumed for clerical, typographical, or proofreading errors, or omissions.

2012.9

In the interest of product improvement, specifications are subject to change without notice.

**OMRON Corporation**  
Industrial Automation Company

<http://www.ia.omron.com/>

(c)Copyright OMRON Corporation 2012 All Right Reserved.

## X-ON Electronics

Largest Supplier of Electrical and Electronic Components

*Click to view similar products for [Proximity Sensors](#) category:*

*Click to view products by [Omron](#) manufacturer:*

Other Similar products are found below :

[01.001.5653.1](#) [70.340.1028.0](#) [70.360.2428.0](#) [70.364.4828.0](#) [70.810.1053.0](#) [72.360.1628.0](#) [73.363.6428.0](#) [8027AL20NL2CPXX](#) [FYCC8E1-2](#)  
[9221350022](#) [922AA2W-A9P-L](#) [PLS2](#) [GL-12F-C2.5X10\(LOT3\)](#) [972AB2XM-A3N-L](#) [972AB3XM-A3P-L](#) [PS3251](#) [980659-1](#) [QT-12](#) [E2E2-](#)  
[X5M41-M4](#) [E2E-X14MD1-G](#) [E2E-X2D1-G](#) [E2EX2ME2N](#) [E2EX3D1SM1N](#) [E2E-X4MD1-G](#) [E2E-X5E1-5M-N](#) [E2E-X5Y2-N](#) [E2E-X7D1-](#)  
[M1J-T-0.3M-N](#) [E2FMX1R5D12M](#) [E2K-F10MC1](#) [5M](#) [EH-302](#) [EI3010TBOP](#) [EI5515NPAP](#) [MS605AU](#) [EP175-32000](#) [IFRM04N35B1/L](#)  
[IFRM04P1513/S35L](#) [IFRM06P1703/S35L](#) [IFRM08P1501/S35L](#) [IFRM12N17G3/L](#) [IFRM12P17G3/L](#) [IFRM12P3502/L](#) [IFRM12P37G1/S14L](#)  
[ILFK12E9189/I02](#) [ILFK12E9193/I02](#) [IMM2582C](#) [OISN-013](#) [25.161.3253.0](#) [25.332.0653.1](#) [25.352.0653.0](#) [25.352.0753.0](#)