

# V680 Series

## RFID Systems with ISO/IEC 18000-3 (15693) Compliance

- High-speed communications and highly reliable communications provided with an electromagnetic induction system and unique technology.
- Antennas and RF Tags with excellent environmental resistance.
- Wide line-up of ultra-compact, long-life RF Tags, with capacities from 1 to 8 kbytes.
- Visualizes the communications status for simple analysis of the operating environment.
- Complies with FCC Rules and R&TTE Directive.



## System Configuration

Connect V680 Antennas and Amplifier Units to a V680-series Controller, and read or write data from or to RF Tags.



\* For information on the combinations that can be used, refer to *Combinations of Amplifier Units, Antennas, and RF Tags* on page 3.

# V680 Series

## Handheld Type

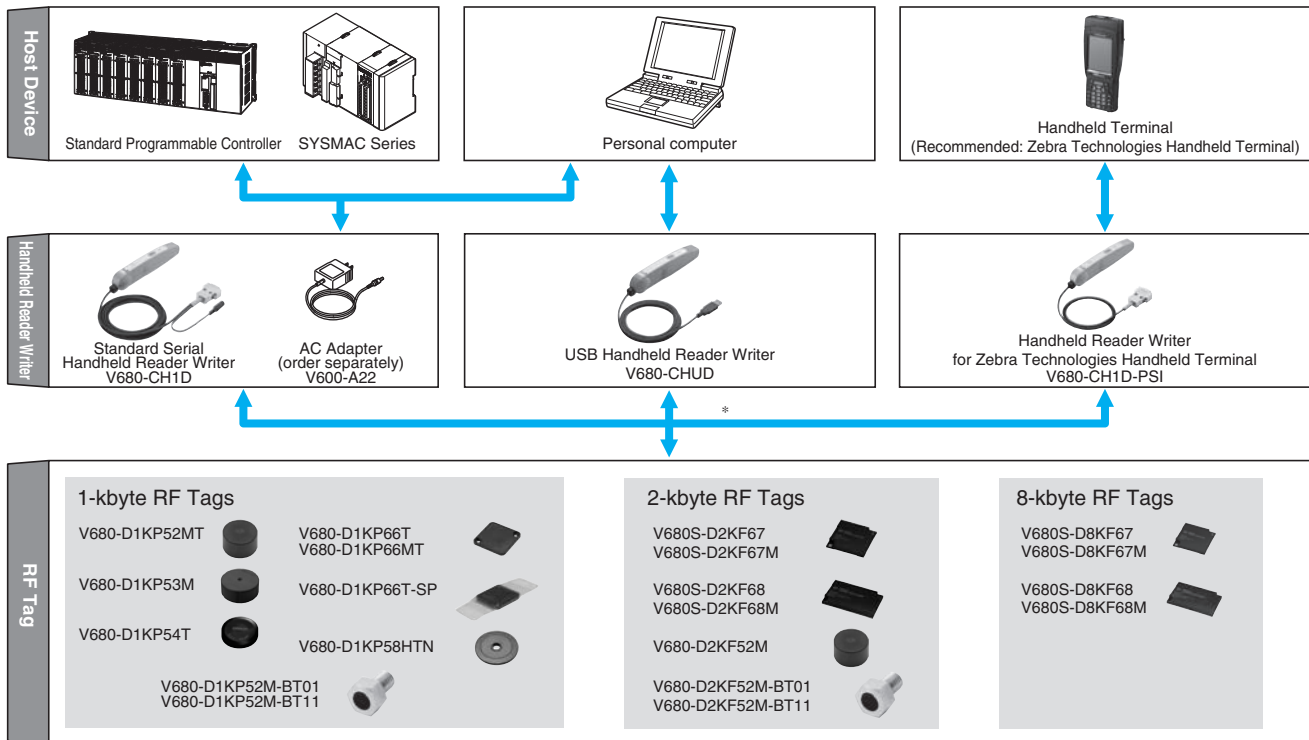

**Note:** Certificated as type approval of radio in 51 countries including Japan, European countries and the USA . However, some models cannot be used. Contact your OMRON sales representative for details on whether application is supported in other countries.  
The latest information on the status of certification for radio wave regulations in various countries can be confirmed on the OMRON website.

\* For information on the combinations that can be used, refer to *Combinations of Amplifier Units, Antennas, and RF Tags* on page 3.

### Combinations of Amplifier Units, Antennas, and RF Tags

#### 1-kbyte RF Tags

Amplifier Unit	Antenna	EEP-ROM							
		1-kbyte							
		V680-D1KP52MT	V680-D1KP53M	V680-D1KP54T	V680-D1KP66T	V680-D1KP66MT	V680-D1KP66T-SP	V680-D1KP58HTN	V680-D1KP52M-BT□1
V680-HA63A V680-HAM42-DRT V680-HAM□1	V680-HS51	Yes	Yes						Yes
	V680-HS52-□	Yes	Yes	Yes	Yes	Yes	Yes		Yes
	V680-HS63-□	Yes*		Yes	Yes	Yes	Yes		
	V680-HS65-□			Yes	Yes	Yes	Yes	Yes	
V680-HAM42-PRT	V680-HS63-W	Yes*			Yes	Yes	Yes		
	V680-HS65-W				Yes	Yes	Yes		
V680-H01-V2 (Antenna with Built-in Amplifier)					Yes			Yes	
V680-CH□D (Handheld Reader Writer)		Yes	Yes		Yes	Yes	Yes	Yes	

#### 2-kbyte RF Tags

Amplifier Unit	Antenna	FRAM					
		2-kbyte					
		V680-D2KF52M	V680-D2KF52M-BT□1	V680S-D2KF67	V680S-D2KF67M	V680S-D2KF68	V680S-D2KF68M
V680-HA63B V680-HAM42-DRT V680-HAM□1	V680-HS51	Yes	Yes				
	V680-HS52-□	Yes	Yes	Yes	Yes		
	V680-HS63-□	Yes*		Yes	Yes	Yes	Yes
	V680-HS65-□			Yes	Yes	Yes	Yes
V680-HAM42-PRT	V680-HS63-W			Yes	Yes	Yes	Yes
	V680-HS65-W			Yes	Yes	Yes	Yes
V680-H01-V2 (Antenna with Built-in Amplifier)				Yes		Yes	
V680-CH□D (Handheld Reader Writer)		Yes		Yes	Yes	Yes	Yes

#### 8-kbyte RF Tags

Amplifier Unit	Antenna	FRAM			
		8-kbyte			
		V680S-D8KF67	V680S-D8KF67M	V680S-D8KF68	V680S-D8KF68M
V680-HA63B V680-HAM42-DRT V680-HAM□1	V680-HS51				
	V680-HS52-□	Yes	Yes		
	V680-HS63-□	Yes	Yes	Yes	Yes
	V680-HS65-□	Yes	Yes	Yes	Yes
V680-HAM42-PRT	V680-HS63-W	Yes	Yes	Yes	Yes
	V680-HS65-W	Yes	Yes	Yes	Yes
V680-H01-V2 (Antenna with Built-in Amplifier)		Yes		Yes	
V680-CH□D (Handheld Reader Writer)		Yes	Yes	Yes	Yes

**Note:** For details, refer to the relevant user's manual (Z248, Z249, Z262, Z271, Z272, Z278, Z279, and Z339).

\* When using the V680-D1KP52MT or V680-D2KF52M embedded in metal, use the V680-HS51/-HS52 Antenna.

Communications will not be possible if the V680-HS63 Antenna is used.

Communications will not be possible if the V680-HS65 Antenna is used with the V680-D1KP52MT, V680-D1KP53M, or V680-D2KF52M.

Communication is also possible with RF Tags other than those of the V680 Series as long as they comply with ISO/IEC 18000-3 (ISO/IEC 15693). However, communication with RF Tags other than those of the V680 Series cannot be assured. The user must confirm communication capabilities carefully prior to use.

# V680 Series





## Ordering Information

### RF Tag

Type	Memory capacity	Appearance	Size	Metallic compatibility	Model	
Battery-less	1 kbyte		8 dia. × 5 mm	For embedding in metallic or non-metallic surface	V680-D1KP52MT	
			10 dia. × 4.5 mm	For embedding in metallic or non-metallic surface	V680-D1KP53M	
			20 dia. × 2.7 mm	For flush mounting on non-metallic surface	V680-D1KP54T	
			34 × 34 × 3.5 mm	For flush mounting on metallic surface	V680-D1KP66MT	
				For flush mounting on non-metallic surface	V680-D1KP66T	
			95 × 36.5 × 6.5 mm	For flush mounting on non-metallic surface	V680-D1KP66T-SP	
			80 dia. × t10 mm	For flush mounting on non-metallic surface	V680-D1KP58HTN	
		M10 × 12 mm	For mounting as bolts	V680-D1KP52M-BT01 *		
		M8 × 12 mm		V680-D1KP52M-BT11 *		
	2 kbytes	8 kbytes		8 dia. × 5 mm	For embedding in metallic or non-metallic surface	V680-D2KF52M
				40 × 40 × 5 mm	For flush mounting on metallic surface	V680S-D2KF67M
		For flush mounting on non-metallic surface			V680S-D2KF67	
			86 × 54 × 10 mm	For flush mounting on metallic surface	V680S-D2KF68M	
				For flush mounting on nonmetallic surface	V680S-D2KF68	
			M10 × 12 mm	For mounting as bolts	V680-D2KF52M-BT01 *	
			M8 × 12 mm		V680-D2KF52M-BT11 *	
	8 kbytes		40 × 40 × 5 mm	For flush mounting on metallic surface	V680S-D8KF67M	
				For flush mounting on non-metallic surface	V680S-D8KF67	
		86 × 54 × 10 mm	For flush mounting on metallic surface	V680S-D8KF68M		
			For flush mounting on nonmetallic surface	V680S-D8KF68		

\* Place orders in units of boxes (containing 20 units).

**Antenna (Detachable Amplifier Unit Type)**



Type	Appearance	Size	Cable length	Model		
Cylindrical	Standard cable, waterproof connector 	M22 × 65 mm	2 m	V680-HS52-W 2M		
			12.5 m	V680-HS52-W 12.5M		
	Flexible cable, nonwaterproof connector		2 m	V680-HS52-R 2M		
			12.5 m	V680-HS52-R 12.5M		
Standard cable, nonwaterproof connector 	M12 × 35 mm	2 m	V680-HS51 2M			
Square	Standard cable, waterproof connector 	40 × 53 × 23 mm	2 m	V680-HS63-W 2M		
			12.5 m	V680-HS63-W 12.5M		
			Flexible cable, nonwaterproof connector	2 m	V680-HS63-R 2M	
				12.5 m	V680-HS63-R 12.5M	
	Standard cable, waterproof connector 		100 × 100 × 30 mm	2 m	V680-HS65-W 2M	
				12.5 m	V680-HS65-W 12.5M	
				Flexible cable, nonwaterproof connector	2 m	V680-HS65-R 2M
					12.5 m	V680-HS65-R 12.5M

**Antenna with Built-in Amplifier**



Type	Appearance	Size	Cable length	Model
Square		250 × 200 × 35 mm	0.5 m *	V680-H01-V2

\* Use an Antenna Cable to connect the Antenna to the Controller.  
The maximum cable length is 30.5 m.

**Amplifier Unit**



Type	Appearance	Size	Cable length	Model		
For 1-kbyte memory		25 × 40 × 65 mm	0.5 m	V680-HA63A 0.5M		
			5 m	V680-HA63A 5M		
			10 m	V680-HA63A 10M		
For 2-/8-kbyte memory				25 × 40 × 65 mm	0.5 m	V680-HA63B 0.5M
					5 m	V680-HA63B 5M
					10 m	V680-HA63B 10M

**ID Controller**

Type	No. of connectable Amplifiers	Appearance	Size	Communication interface	Model
DC power supply	Single		105 × 90 × 65 mm	RS232C, RS422/RS485	V680-CA5D01-V2
	Dual				V680-CA5D02-V2

# V680 Series

## RFID Units

RFID Units	Appearance	Product name	Amplifier/Antenna	No. of unit numbers used	Model
NX-series RFID Units		RFID Units	V680 series	1	<b>NX-V680C1</b>
				2	<b>NX-V680C2</b>

## ID Sensor Units

Type	Appearance	Connected ID System	External power supply	No. of unit numbers used	Current consumption (A)			Model	
					5 V	24 V	External		
CJ Special I/O Unit		V680 Series	-	1 Head	1 unit number	0.26	0.13 *	-	<b>CJ1W-V680C11</b>
				2 Heads	2 unit number	0.32	0.26	-	<b>CJ1W-V680C12</b>



Type	Appearance	Connected ID System	External power supply	No. of unit numbers used	Current consumption (A)			Model	
					5 V	26 V	External		
CS Special I/O Unit		V680 Series	-	1 Head	1 unit number	0.26	0.13 *	-	<b>CS1W-V680C11</b>
				2 Heads	2 unit number	0.32	-	0.36	<b>CS1W-V680C12</b>

\* When connected to the V680-H01: 0.28 A

## Amplifier-integrated Controller (DeviceNet ID Slave/PROFIBUS ID Slave)

Appearance	Size	Network Compatibility	Model
	65 × 65 × 65 mm	DeviceNet	<b>V680-HAM42-DRT</b>
		PROFIBUS	<b>V680-HAM42-PRT</b>

## Amplifier-integrated Controllers (ID Flag Sensors)

Type	Appearance	Size	Model
NPN output		90 × 30 × 65 mm	<b>V680-HAM91</b>
PNP output			<b>V680-HAM81</b>

## Special Interface Cables (for V680-HAM91 and V680-HAM81)

Cable length	Model	Appearance
2 m	<b>V680-A60 2M</b>	
5 m	<b>V680-A60 5M</b>	
10 m	<b>V680-A60 10M</b>	

**Note:** 1. The connectors are not waterproof.

2. The cable length can be extended to a maximum of 10 m.





3. Normally two Interface Cables are required for 1 Unit. If you do not need to write to ID Tags, or use the address shift or noise check functions, then one Interface Cable is sufficient.

## Handheld Reader Writers

Name	Appearance	Model
Model with standard serial connector		V680-CH1D
Model with USB connector and 0.8-m cable		V680-CHUD 0.8M
Model with USB connector and 1.9-m cable		V680-CHUD 1.9M
Models for Zebra Technologies Handheld Terminal		V680-CH1D-PSI
AC Adapter (for V680-CH1D)		V600-A22

## Accessories (Order Separately)

## RF Tag Attachment

Type	Appearance	Model
For the V680-D1KP66T		V600-A86
For the V680-D□KF68		V680-A81
To mount the V680-D1KP58HTN		V680-A80
For the V680-D1KP54T		V700-A80

## Amplifier Unit Special Extension Cable (Amplifier Unit to Controller)

Cable length	Appearance	Model
2 m		V700-A40 2M
3 m		V700-A41 3M
5 m		V700-A42 5M
10 m		V700-A43 10M
20 m		V700-A44 20M
30 m		V700-A45 30M

**Note:** The cable can be extended up to 40 m. Up to two extension cables can be used.

## V680-H01 Antenna Special Cable (Antenna to Controller)

Cable length	Appearance	Model
2 m		V700-A40-W 2M
5 m		V700-A40-W 5M
10 m		V700-A40-W 10M
20 m		V700-A40-W 20M
30 m		V700-A40-W 30M

**Note:** The cable can be extended up to 30 m. Only one extension cable can be used.

## RS-232C Communications Connector

Name	Model
Connector Plug	XM3B-0922-111
Connector Hood	XM2S-0911

\* An RS422/RS485 Communications Connector is attached to the Controller.

## ID Map Manager

Type	Model
Japanese version	V680-A-IMMJJP-P03 *
English version	V680-A-IMMEG-P03 *
Chinese version	V680-A-IMMCN-P03 *

\* Supported operating system: Windows 7, Windows10  
For details, consult your OMRON representative.

# V680 Series

## Ratings and Performance

### RF Tag (1-kbyte Memory)

Item	Model	V680-D1KP52MT	V680-D1KP54T	V680-D1KP66T	V680-D1KP66MT	V680-D1KP53M	V680-D1KP66T-SP
Memory capacity		1,000 byte (user area)					
Memory type		EEPROM					
Data retention time *1		10 years after writing (85°C max.)					
Write endurance		100,000 times per block (at 25°C)					
Ambient operating temperature (during communication)		-25 to 85°C (with no icing)				-25 to 70°C (with no icing)	
Ambient storage temperature (during data backup)		-40 to 125°C (with no icing) Heat resistance: 1,000 thermal cycles each of 30 minutes at -10°C/150°C, High-temperature storage: 1,000 hours at 150°C *2 200 thermal cycles each of 30 minutes at -10°C/180°C, High-temperature storage: 200 hours at 180°C *3			-40 to 125°C (with no icing)		-40 to 110°C (with no icing)
Ambient operating humidity		35 to 95%					
Degree of protection		IP68 (IEC 60529:2001) Oil resistance equivalent to IP67G (JIS C 0920:2003, Appendix 1) *4	IP67 (IEC 60529:2001) Oil resistance equivalent to IP67G (JIS C 0920:2003, Appendix 1) *4	IP68 (IEC 60529:2001) Oil resistance equivalent to IP67G (JIS C 0920:2003, Appendix 1) *4			IP67
Vibration resistance		10 to 2,000 Hz, 1.5-mm double amplitude at 150 m/s <sup>2</sup> acceleration with 10 sweeps in X, Y, and Z directions for 15 minutes each					
Shock resistance		500 m/s <sup>2</sup> in X, Y, and Z directions 3 times each (18 times in total)					
Appearance		8 dia. × 5 mm	20 dia. × 2.7 mm	34 × 34 × 3.5 mm		10 dia. × 4.5 mm (DIN698373)	95 × 36.5 × 6.5 mm (excluding protrusions)
Materials		Case: PPS resin Filling: Epoxy resin	Molding: PPS resin			Case: PPS resin Filling: Epoxy resin	External resin: PFA Tag body: PPS resin
Weight		Approx. 0.5 g	Approx. 2 g	Approx. 6 g	Approx. 7.5 g	Approx. 1 g	Approx. 20 g
Metallic compatibility		Yes	No	No	Yes	Yes	No

**Note:** For details, refer to the User's Manual (Cat. No. Z262).

- \*1. Refer to the User's Manual (Cat. No. Z262) for data retention time for temperatures of 85°C or higher. If the V680 has been stored at 125°C or higher, write the data again even if the data does not need to be changed.
- \*2. 150°C heat resistance: The heat resistance has been checked at 150°C for up to 1,000 hours, and thermal shock has been checked through testing 1,000 thermal cycles each of 30 minutes at -10/150°C. (Test samples: 22, defects: 0)
- \*3. 180°C heat resistance: The heat resistance has been checked at 180°C for up to 200 hours, and thermal shock has been checked through testing 200 thermal cycles each of 30 minutes at -10°C/180°C. (Test samples: 22, defects: 0)
- \*4. Oil resistance has been tested using a specific oil as defined in the OMRON test method.

### RF Tag with 1-kbyte Memory with High-temperature Capability

Item	Model	V680-D1KP58HTN
Memory capacity		1,000 bytes (user area)
Memory type		EEPROM
Data Retention		10 years after writing (85°C or less), 0.5 year after writing (85°C to 125°C) Total data retention at high temperatures exceeding 125°C is 10 hours *1
Write Endurance		100,000 times per block (25°C)
Ambient operating temperature		-25°C to 85°C (with no icing)
Ambient storage temperature		-40 to 250°C (with no icing) *2 (Data retention: -40 to 125°C) 1. 2,000 cycles of 30 minutes each between room temperature and 200°C 2. 500 hours at 250°C
Ambient storage humidity		No restrictions.
Degree of protection		IP67 (IEC 60529:2001) Oil resistance equivalent to IP67G (JIS C 0920:2003, Appendix 1) *3
Vibration resistance		10 to 2,000 Hz, 1.5-mm double amplitude, acceleration: 150 m/s <sup>2</sup> , 10 sweeps each in X, Y, and Z directions for 15 minutes each
Shock resistance		500 m/s <sup>2</sup> , 3 times each in X, Y, and Z directions (total: 18 times)
Materials		PPS resin
Weight		Approx. 70 g

- \*1 After storing data at high temperatures, rewrite the data even if changes are not required. High temperatures are those exceeding 125°C up to 250°C.
- \*2 Storing RF Tags under high temperatures or under heat cycles will adversely affect the performance of the internal parts and the service life of the RF Tags. The RF Tag were placed in the following high temperatures and then evaluated in-house. It was confirmed that no problems occurred.
  1. 2,000 cycles of 30 minutes each between room temperature and 200°C.
  2. 500 hours at 250°C.
- \*3 Oil resistance has been tested using a specific oil as defined in the OMRON test method.



## RF Tag (2-kbyte Memory)

Item	Model	V680S-D2KF67	V680S-D2KF67M	V680S-D2KF68	V680S-D2KF68M	V680-D2KF52M
Memory capacity		2,000 bytes (user area)				
Memory type		FRAM				
Data retention time *1		10 years after writing at 85°C				10 years after writing (55°C max.)
Write endurance		One trillion writes for each block(85°C or less), Number of accesses *2: One trillion writes				Access frequency per block *2: 10 billion times
Ambient operating temperature		-20 to 85°C (with no icing)				-25 to 85°C (with no icing)
Ambient storage temperature		-40 to 125°C (with no icing)				-40 to 125°C (with no icing)
Ambient operating humidity		35 to 85%				35 to 95%
Degree of protection		IP68 (IEC 60529:2001), Oil resistance equivalent to IP67G (JIS C 0920:2003, Appendix 1) *3 IPX9K (DIN 40 050)				IP67 (IEC 60529:2001) Oil resistance equivalent to IP67G (JIS C 0920:2003, Appendix 1) *3
Vibration resistance		10 to 2,000 Hz, 1.5-mm double amplitude at 150 m/s <sup>2</sup> acceleration with 10 sweeps in X, Y, and Z directions for 15 minutes each		No abnormality after application of 10 to 500 Hz, 1.5-mm double amplitude, acceleration: 100 m/s <sup>2</sup> , 10 sweeps each in X, Y, and Z directions for 11 minutes each		10 to 2,000 Hz, 1.5-mm double amplitude at 150 m/s <sup>2</sup> acceleration with 10 sweeps in X, Y, and Z directions for 15 minutes each
Shock resistance		500 m/s <sup>2</sup> in X, Y, and Z directions 3 times each (Total:18 times)				
Appearance		40 × 40 × 5 mm		86 × 54 × 10 mm		8 dia. × 5 mm
Materials		Exterior: PPS resin				Case: PPS resin Filling: Epoxy resin
Weight		Approx. 12 g	Approx. 11.5 g	Approx. 44 g	Approx. 46 g	Approx. 0.5 g
Metallic compatibility		No	Yes	No	Yes	Yes

**Note:** For details, refer to the User's Manual (Cat. No. Z248 or Z339).

\*1. Refer to the User's Manual (Cat. No. Z248) for data retention time for temperatures of 55°C or higher.

\*2. The total Read or Write communication frequency is called the access frequency.

\*3. Oil resistance has been tested using a specific oil as defined in the OMRON test method.

## RF Tag with 8-kbyte Memory

Item	Model	V680S-D8KF67	V680S-D8KF67M	V680S-D8KF68	V680S-D32KF68M	
Memory capacity		8,192 bytes (user area)				
Memory type		FRAM				
Data retention time		10 years after writing (85°C or less)				
Write endurance		1 trillion times per block. *1 Access frequency : 1 trillion times:				
Ambient operating temperature		-20 to 85°C (with no icing)				
Ambient storage temperature		-40 to 125°C (with no icing)				
Ambient operating humidity		35 to 85%				
Degree of protection		IP68 (IEC 60529:2001), Oil resistance equivalent to IP67G (JIS C 0920:2003, Appendix 1) *2 IPX9K (DIN 40 050)				
Vibration resistance		10 to 2,000 Hz, 1.5-mm double amplitude at 150 m/s <sup>2</sup> acceleration with 10 sweeps in X, Y, and Z directions for 15 minutes each		10 to 500 Hz, 1.5-mm double amplitude at 100 m/s <sup>2</sup> acceleration with 10 sweeps in X, Y, and Z directions for 11 minutes each		
Shock resistance		500 m/s <sup>2</sup> in X, Y, and Z directions 3 times each (18 times in total)				
Dimensions		40 × 40 × 4.5 mm		86 × 54 × 10 mm		
Materials		Molding: PPS resin				
Weight		Approx. 11.5 g	Approx. 12 g	Approx. 44 g	Approx. 46 g	
Metallic compatibility		No	Yes	No	Yes	

**Note:** For details, refer to the User's Manual (Cat. No. Z339).

\*1. The total Read or Write communication frequency is called the access frequency.

\*2. Oil resistance has been tested using a specific oil as defined in the OMRON test method.

# V680 Series

## Bolt RF Tags (1-kbyte Memory)

Item	Model	V680-D1KP52M-BT01	V680-D1KP52M-BT11
Memory capacity		1,000 bytes (user area)	
Memory type		EEPROM	
Data retention time		10 years after writing (85°C or less), 0.5 years after writing (85 to 125°C) Total data retention at high temperatures exceeding 125°C is 10 hours	
Write endurance		100,000 times per block (at 25°C)	
Ambient operating temperature (during communication)		-25 to 85°C (with no icing)	
Ambient storage temperature (during data backup)		-40 to 125°C (with no icing)	
Ambient operating humidity		35 to 95%	
Degree of protection		IP68 (IEC 60529:2001) Oil resistance equivalent to IP67G (JIS C 0920:2003, Appendix 1) *	
Vibration resistance		10 to 2,000 Hz, 1.5-mm double amplitude at 150 m/s <sup>2</sup> acceleration with 10 sweeps in X, Y, and Z directions for 15 minutes each	
Shock resistance		500 m/s <sup>2</sup> in X, Y, and Z directions 3 times each (18 times in total)	
Materials		Bolt: SUS303, Case (RF Tag): PPS resin, Filling (RF Tag): Epoxy resin	
Weight		Approx. 25 g	Approx. 10 g

\* Oil resistance has been tested using a specific oil as defined in the OMRON test method.

## Bolt RF Tags (2-kbyte Memory)

Item	Model	V680-D2KF52M-BT01	V680-D2KF52M-BT11
Memory capacity		2,000 bytes (user area)	
Memory type		FRAM	
Data retention time		10 years after writing (55°C or less), 2.9 years after writing (85°C max.)	
Write endurance		10 billion reads/writes per block, Number of accesses *1: 10 billion times	
Ambient operating temperature (during communication)		-25°C to 85°C (with no icing)	
Ambient storage temperature (during data backup)		-40°C to 85°C (with no icing)	
Ambient operating humidity		35 to 95%	
Degree of protection		IP67 (IEC 60529:2001) Oil resistance equivalent to IP67G (JIS C 0920:2003, Appendix 1) *2	
Vibration resistance		10 to 2,000 Hz, 1.5-mm double amplitude at 150 m/s <sup>2</sup> acceleration with 10 sweeps in X, Y, and Z directions for 15 minutes each	
Shock resistance		500 m/s <sup>2</sup> in X, Y, and Z directions 3 times each (18 times in total)	
Materials		Bolt: SUS303, Case (RF Tag): PPS resin, Filling (RF Tag): Epoxy resin	
Weight		Approx. 25 g	Approx. 10 g

\*1 The number of accesses is the total number of communications for reading or writing.

\*2 Oil resistance has been tested using a specific oil as defined in the OMRON test method.

## Cylindrical Antenna (Detachable Amplifier Unit Type)

Item	Model	V680-HS51 (Standard Cable, Non-waterproof Connector)	V680-HS52-W (Standard Cable, Waterproof Connector)	V680-HS52-R (Standard Cable, Non-waterproof Connector)
Ambient operating temperature		-10°C to 60°C (with no icing)		
Ambient storage temperature		-25°C to 75°C (with no icing)		
Ambient operating humidity		35% to 95% (with no condensation)		
Insulation resistance		20 MΩ min. (at 500 VDC) between the cable terminals and the case		
Dielectric strength		1,000 VAC (50/60 Hz) for 1 minute between the cable terminals and the case with a current leakage of 5 mA max.		
Degree of protection		IP67 (IEC 60529:2001) Oil resistance equivalent to IP67G (JIS C 0920:2003, Appendix 1) (Antenna portion) *2	IP67 (IEC 60529:2001) Oil resistance equivalent to IP67G (JIS C 0920:2003, Appendix 1) (Antenna portion) *1	IP67 (IEC 60529:2001) Oil resistance equivalent to IP67G (JIS C 0920:2003, Appendix 1) (Antenna portion) *2
Vibration resistance		10 to 2,000 Hz variable vibration, 1.5-mm double amplitude at 150 m/s <sup>2</sup> acceleration, with 10 sweeps in X, Y, and Z directions for 15 minutes each	10 to 500 Hz variable vibration, 1.5-mm double amplitude at 100 m/s <sup>2</sup> acceleration, with 10 sweeps in X, Y, and Z directions for 8 minutes each	
Shock resistance		1,000 m/s <sup>2</sup> in X, Y, and Z directions 3 times each (18 times in total)	500 m/s <sup>2</sup> in X, Y, and Z directions 3 times each (18 times in total)	
Appearance		M12 × 35 mm	M22 × 65 mm	
Materials		ABS, brass, epoxy resin filling		
Weight		Approx. 55 g (with 2-m cable)	Approx. 850 g (with 12.5-m cable)	

**Note:** For details, refer to the User's Manual (Cat. No. Z248 or Z262).

\*1. The degree of protection for the Connector is IP67/IP65. This OMRON in-house standard confirms resistance to cutting and other oils. It is equivalent to the former JEM1030 standard.

\*2. The Connector is not waterproof. Oil resistance has been tested using a specific oil as defined in the OMRON test method.

## Square Antenna (Detachable Amplifier Unit Type)

Item	Model	V680-HS63-W (Standard Cable, Waterproof Connector)	V680-HS63-R (Flexible Cable, Non-waterproof Connector)
Ambient operating temperature		-10°C to 60°C (with no icing)	
Ambient storage temperature		-25°C to 75°C (with no icing)	
Ambient operating humidity		35% to 95% (with no condensation)	
Insulation resistance		20 MΩ min. (at 500 VDC) between the cable terminals and the case	
Dielectric strength		1,000 VAC (50/60 Hz) for 1 minute between the cable terminals and the case with a current leakage of 5 mA max.	
Degree of protection		IP67 (IEC 60529:2001) Oil resistance equivalent to IP67G (JIS C 0920:2003, Appendix 1) (Antenna portion) *1	IP67 (IEC 60529:2001) Oil resistance equivalent to IP67G (JIS C 0920:2003, Appendix 1) (Antenna portion) *2
Vibration resistance		10 to 500 Hz variable vibration, 1.5-mm double amplitude at 100 m/s <sup>2</sup> acceleration, with 10 sweeps in X, Y, and Z directions for 11 minutes each	
Shock resistance		500 m/s <sup>2</sup> in X, Y, and Z directions 3 times each (18 times in total)	
Appearance		40 × 53 × 23 mm	
Materials		ABS, epoxy resin filling	
Weight		Approx. 850 g (with 12.5-m cable)	

Item	Model	V680-HS65-W (Standard Cable, Waterproof Connector)	V680-HS65-R (Flexible Cable, Non-waterproof Connector)
Ambient operating temperature		-25°C to 70°C (with no icing)	
Ambient storage temperature		-40°C to 85°C (with no icing)	
Ambient operating humidity		35% to 95% (with no condensation)	
Insulation resistance		20 MΩ min. (at 500 VDC) between the cable terminals and the case	
Dielectric strength		1,000 VAC (50/60 Hz) for 1 minute between the cable terminals and the case with a current leakage of 5 mA max.	
Degree of protection		IP67 (IEC 60529:2001) Oil resistance equivalent to IP67G (JIS C 0920:2003, Appendix 1) (Antenna portion) *1	IP67 (IEC 60529:2001) Oil resistance equivalent to IP67G (JIS C 0920:2003, Appendix 1) (Antenna portion) *2
Vibration resistance		10 to 500 Hz variable vibration, 1.5-mm double amplitude at 100 m/s <sup>2</sup> acceleration, with 10 sweeps in X, Y, and Z directions for 11 minutes each	
Shock resistance		500 m/s <sup>2</sup> in X, Y, and Z directions 3 times each (18 times in total)	
Appearance		100 × 100 × 30 mm	
Materials		ABS, epoxy resin filling	
Weight		Approx. 1,100 g (with 12.5-m cable)	

**Note:** For details, refer to the User's Manual (Cat. No. Z248 or Z262).

\*1. The degree of protection for the Connector is IP67/IP65. Oil resistance has been tested using a specific oil as defined in the OMRON test method.

\*2. The Connector is not waterproof. Oil resistance has been tested using a specific oil as defined in the OMRON test method.

## V680 Series

### Square Antenna with Built-in Amplifier

Item	Model	V680-H01-V2
Ambient operating temperature		-10°C to 55°C (with no icing)
Ambient storage temperature		-35°C to 65°C (with no icing)
Ambient operating humidity		35% to 85% (with no condensation)
Insulation resistance		20 MΩ min. (at 100 VDC) between connector terminals and the rear plate
Dielectric strength		1,000 VAC, 50/60 Hz for 1 min between connector terminals and the rear plate
Degree of protection		IP63. (IEC60529); Mounting direction: Communications surface facing up
Vibration resistance		10 to 150 Hz, 0.35-mm single amplitude, acceleration: 50 m/s <sup>2</sup> , 10 sweeps in each of 3 axis directions (up/down, left/right, and forward/backward) for 8 minutes each
Shock resistance		150 m/s <sup>2</sup> , 3 times each in 6 directions (Total: 18 times)
Appearance		200 × 250 × 40 mm
Material		Polycarbonate (PC) resin, ASA resin / Rear Panel: Aluminum
Weight		Approx. 900 g
Cable length		0.5 m (use a relay cable to connect to the Controller up to 30.5 m)

Note: For details, refer to the User's Manual (Cat. No. Z248 or Z262).

### ID Controller

Item	Model	V680-CA5D01-V2	V680-CA5D02-V2
Power supply voltage (Power consumption)		24 VDC (-15% to +10%) 15 W max., 0.8 A max.	
Communications Specifications		RS-232C, RS-422, RS-485	
Input Specifications (Input voltage) RST, TRG1, and TRG2		24 VDC (+10% to -15%, including ripple) (PNP and NPN compatible)	
Output Specifications (Maximum switching capacity) RUN, BUSY/OUT3, ERROR/OUT4, OUT1, and OUT2		24 VDC (+10% to -15%, including ripple) PNP and NPN compatible	
Ambient operating temperature		-10 to 55°C (with no icing)	
Ambient storage temperature		-25 to 65°C (with no icing)	
Ambient operating humidity		25% to 85% (with no condensation)	
Insulation resistance		20 MΩ min. (at 500 VDC) applied as follows: (1) Between power supply terminals and grounded case (2) Between ground and terminals	
Dielectric strength		1,000 VAC (50/60 Hz) for 1 minute (1) Between power supply terminals and grounded case (2) Between ground and terminals	
Degree of protection		Panel mounted (equivalent to IP20)	
Vibration resistance		10 to 150 Hz variable vibration, 0.2-mm double amplitude at 15 m/s <sup>2</sup> acceleration, with 10 sweeps in X, Y, and Z directions for 8 minutes each	
Shock resistance		150 m/s <sup>2</sup>	
Appearance		105 × 90 × 65 mm (not including projections)	
Material		Polycarbonate (PC) resin, ABS resin	
Weight		Approx. 300 g	
Connectable Amplifier Units		1	2

Note: For details, refer to the User's Manual (Cat. No. Z249).

### USB Port

The USB port is used for a simple connection with a personal computer using a USB cable. The port complies with USB 1.1, and the USB cable uses a series A or series mini-B connector. A USB port driver must be separately provided. Consult with your OMRON representative for details. When connected to a host device via USB, the communications will use 1:1 protocol regardless of the setting of DIP switches 3 to 9.

The USB port is not used for control purposes. When building a system, be sure to provide an RS-232C port or RS-422/RS-485C port.

### Amplifier Unit

Item	Model	V680-HA63A	V680-HA63B
Ambient operating temperature		-10°C to 55°C (with no icing)	
Ambient storage temperature		-25°C to 65°C (with no icing)	
Ambient operating humidity		35% to 85% (with no condensation)	
Insulation resistance		20 MΩ min. (at 500 VDC) between the cable terminals and the case	
Dielectric strength		1,000 VAC (50/60 Hz) for 1 minute between the cable terminals and the case with a current leakage of 5 mA max.	
Degree of protection		IP40 (IEC60529) *1	IP67/IP65 (IEC60529) *2
Vibration resistance		10 to 500 Hz variable vibration, 1.5-mm double amplitude at 100 m/s <sup>2</sup> acceleration, with 10 sweeps in X, Y, and Z directions for 11 minutes each	
Shock resistance		500 m/s <sup>2</sup> in X, Y, and Z directions 3 times each (18 times in total)	
Appearance		25 × 40 × 65mm (not including projections)	
Material		Polycarbonate (PC) resin	
Weight		Approx. 650 g (with 10-m cable)	
Cable length		5 m, 10 m	
Transmittable RF Tags		1-kbyte memory	2-, 8-kbyte memory

Note: For details, refer to the User's Manual (Cat. No. Z248 or Z262).

\*1. When connected to the V680-HS□□-R or V680-HS52-R.

\*2. When connected to the V680-HS□□-W or V680-HS52-W. (Not including the Connector on the Controller.)

## RFID Units

Item	Model	NX-V680C1	NX-V680C2
<b>Enclosure</b>		Mounted in a panel	
<b>Grounding Methods</b>		Ground to less than 100 Ω	
<b>Operating environment</b>	<b>Ambient operating temperature</b>	0 to 55°C	
	<b>Ambient operating humidity</b>	10 to 95% (with no condensation or icing)	
	<b>Atmosphere</b>	Must be free from corrosive gases.	
	<b>Ambient storage temperature</b>	-25 to 70°C (with no condensation or icing)	
	<b>Altitude</b>	2,000 m max.	
	<b>Pollution degree</b>	2 or less: Conforms to JIS B3502 and IEC 61131-2	
	<b>Noise immunity</b>	2 kV on power supply line (Conforms to IEC61000-4-4.)	
	<b>Overvoltage category</b>	Category II: Conforms to JIS B3502 and IEC 61131-2	
	<b>EMC immunity level</b>	Zone B	
	<b>Vibration resistance</b>	Conforms to IEC 60068-2-6. 5 to 8.4 Hz with amplitude of 3.5 mm, 8.4 to 150 Hz, acceleration of 9.8 m/s <sup>2</sup> 100 min each in X, Y, and Z directions (10 sweeps of 10 min each = 100 min total)	
<b>Shock resistance</b>	Conforms to IEC 60068-2-27, 147 m/s <sup>2</sup> , 3 times each in X, Y, and Z directions		
<b>Applicable standards</b>		cULus: Listed (UL61010-2-201), ANSI/ISA12.12.01, EU: EN61131-2, RCM, KC: KC Registration, EAC	
<b>No. of Amplifier/Antenna connections</b>		1	2

## RFID Units Functions

Function name	Model	NX-V680C1/NX-V680C2
RF Communications option function		This function switches the operation sequence during communications with an RF Tag.
Communications command function		This function reads or writes the memory for a RF Tag on the antenna communications area.
Write protection function		This function prevents the loss of data due to overwriting by specifying the areas in which it is not possible to write to an RF Tag.
RF Tag service life detection function		This function records the number of times data is rewritten to an RF Tag, and determines the maximum rewrite count.
RF Tag memory error detection function		This function detects an error during reading by performing CRC calculation for the memory of an RF Tag.
RF Tag memory error correction function		This function detects an error during reading by performing ECC calculation for the memory of an RF Tag, and corrects the error to an appropriate value.
Test command function		This function checks the margin in communications with an RF Tag, and measures the surrounding noise.

# V680 Series

## ID Sensor Units

Item	Model	CJ1W-V680C11	CJ1W-V680C12	CS1W-V680C11	CS1W-V680C12
Current consumption	Internal: 5 V	260 mA	320 mA	260 mA	320 mA
	Internal: 24 V/26 V	130 mA *	260 mA	125 mA *	–
	External: 24 V	–	–	–	360 mA
Ambient operating temperature	0 to 55°C				
Ambient storage temperature	–20°C to 75°C				
Ambient operating humidity	10% to 90% (with no condensation)				
Insulation resistance	20 mΩ min. at 500 VDC				
Dielectric strength	1,000 VAC for 1 minute				
Degree of protection	Mounted in panel (IP30)				
Vibration resistance	10 to 57 Hz variable vibration, 0.075-mm double amplitude and 57 to 150 Hz variable vibration at 9.8 m/s <sup>2</sup> acceleration, with 10 sweeps in X, Y, and Z directions for 8 minutes each				
Shock resistance	147 m/s <sup>2</sup> in X, Y, and Z directions 3 times each				
Appearance	31 × 65 × 90 mm (excluding protrusions)			35 × 130 × 101 mm (excluding protrusions)	

\* When connected to the V680-H01: 280 mA. The V680-H01-V2 can be connected only to a 1-channel ID Sensor Unit. A 2-channel Unit cannot be used.

## Functional Specifications of ID Sensor Units

Item	Model	CJ1W-V680C11	CJ1W-V680C12	CS1W-V680C11	CS1W-V680C12
Communications control protocol	Special protocol for CS, CJ and NJ PLCs				
Number of Antenna connections	1	2	1	2	
Commands	Supported commands: Read, Write, Bit Set/Bit Clear, Mask Bit Write, Calculation Write, Data Fill, Data Check, Number of Writes Control, Copy (CJ1W-V680C12 and CS1W-V680C12 only), Read with Error Correction/Write with Error Correction, UID Read, and Noise Measurement. The following communications options are supported: Single trigger, Single auto, Repeat auto, FIFO trigger, FIFO repeat *, Multi-access trigger, and Multi-access repeat *				
Data transfer quantity	2,048 bytes max. (160 bytes/scan)				
Diagnostic function	(1) CPU watchdog timer (2) Communications error detection with RF Tag (3) Antenna power supply error				
Monitoring/testing functions	Tag communications can be tested in Test Mode. Status is displayed by LED indicators.				
Number of allocated words	10 words	20 words	10 words	20 words	

**Note:** For details, refer to the User's Manual (Cat. No. Z271).

\* Cannot be used for communications with the V680-D1KP□□.

## Amplifier-integrated Controller (DeviceNet ID Slave/PROFIBUS ID Slave)

Item	Model	V680-HAM42-DRT	V680-HAM42-PRT
Network compatibility		DeviceNet	PROFIBUS DP-V0
Connectable Antennas		One channel (V680-HS□□)	
Rated voltage		24 VDC (–15% to 10%) including 10% ripple (p-p)	
Power consumption		4 W max. (Current consumption of 200 mA max. at power supply voltage of 24 VDC)	
Ambient operating temperature		–10 to 55°C (with no icing)	
Ambient storage temperature		–25 to 65°C (with no icing)	
Ambient operating humidity		25% to 85% (with no condensation; ambient operating temperature is 40°C max. at humidity of 85%)	
Insulation resistance		20 MΩ min. (at 500 VDC) between all terminals excluding the ground terminal and the case	
Dielectric strength		1,000 VAC (50/60 Hz) for 1 minute between all terminals excluding the ground terminal and the case	
Vibration resistance		10 to 150 Hz, 0.2-mm double amplitude at 15 m/s <sup>2</sup> acceleration with 10 sweeps in X, Y and Z directions for 8 minutes each	
Shock resistance		150 m/s <sup>2</sup> in X, Y, and Z directions 3 times each (18 times in total)	
Appearance		65 × 65 × 65 mm (excluding protrusions)	
Degree of protection		IEC 60529, IP20	
Materials		Polycarbonate (PC) resin, ABS resin	
Weight		Approx. 150 g	
Mounting		DIN Track	

Note: 1. For details, refer to the *User's Manual* (Cat. No. Z278).

2. The number of words allocated in the master depends on the Access Mode.

## Amplifier-integrated Controllers (ID Flag Sensors)

Item	Model	V680-HAM91	V680-HAM81
Rated voltage		24 VDC (–15% to +10%) including 10% ripple (p-p)	
Power consumption		3.5 W (24 VDC, 150 mA max. except external I/O line current)	
Input specifications		Transistor output Short-circuit current: 3 mA (typical) (for short-circuit between IN terminal and 0 V), OFF voltage: 15 to 30 VDC, ON voltage: 0 to 5 VDC, Input impedance: 8.2 kΩ, Applied voltage: 30 VDC max.	
Output specifications		NPN open-collector output 30 VDC, 20 mA max., Residual voltage: 2 V max.	PNP open-collector output 30 VDC, 20 mA max., Residual voltage: 2 V max.
Ambient operating temperature		–10 to 55°C (with no icing)	
Ambient storage temperature		–25 to 65°C (with no icing)	
Ambient operating humidity		25% to 85% (with no condensation; ambient operating temperature is 40°C max. at humidity of 85%)	
Insulation resistance		20 MΩ min. (at 500 VDC) between all terminals excluding the FG terminal and the case	
Dielectric strength		1,000 VAC (50/60 Hz) applied for 1 minute between all terminals excluding the FG terminal and the case	
Vibration resistance		10 to 150 Hz, 0.2-mm double amplitude at 15 m/s <sup>2</sup> acceleration with 10 sweeps in X, Y and Z directions for 8 minutes each	
Shock resistance		150 m/s <sup>2</sup> in X, Y, and Z directions 3 times each (18 times in total)	
Appearance		90 × 30 × 65 mm (excluding protrusions)	
Degree of protection		IEC 60529, IP40	
Materials		Polycarbonate (PC) resin, ABS resin	
Weight		Approx. 130 g	
Mounting		DIN Track	

Note: 1. For details, refer to the *User's Manual* (Cat. No. Z279).

2. The connectors are not water resistant. If there is a possibility that water will be splashed onto the ID Sensor Unit, mount it inside of a control box. Also, be sure to use the V680 as a set with the V680-A60 Interface Cable (sold separately).

# V680 Series

## Handheld Reader Writers

Item	Model	V680-CHUD 0.8M	V680-CHUD 1.9M	V680-CH1D	V680-CH1D-PSI
Power supply voltage	5 VDC $\pm$ 5% (at the connector section of the product)				
Current consumption	500 mA max. (for a power supply voltage of 5.0 V)				
Communications specifications	USB (Series A plug) Ver.1.1		RS-232C (D-SUB 9-pin) compatible with IBM PC/AT)		RS-232C (D-SUB 9-pin)
Ambient operating temperature during communication	0 to +40°C				
Ambient storage temperature	-25 to +65°C				
Ambient operating humidity during communication	35% to 85% (with no condensation)				
Insulation resistance	50 M $\Omega$ min. (at 500 VDC) between connector and case				
Dielectric strength	1,000 VAC, 50/60 Hz for 1 min (leakage current: 1 mA max.) between connectors and case				
Degree of protection	IEC 60529: IP63 *				
Vibration resistance	Destruction: 10 to 150 Hz variable vibration, 0.2-mm double amplitude and 15 m/s <sup>2</sup> acceleration with 10 sweeps for 8 min each in 6 directions				
Shock resistance	Destruction: 150 m/s <sup>2</sup> , 3 times each in X, Y, and Z directions				
Weight	Approx. 110 g (including connector and cable)	Approx. 140 g (including connector and cable)	Approx. 170 g (including connector and cable)	Approx. 120 g (including connector and cable)	
Cable length	0.8 m	1.9 m	2.5 m	0.8 m	

**Note:** Refer to the User's Manual (Cat. No. Z272) for details.

Contact your OMRON sales representative for details on drivers for Windows.

\* This does not include the connector section. The main unit is not resistant to chemical or oils.













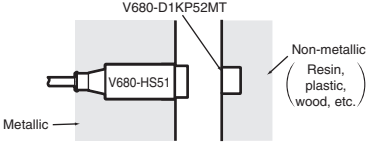

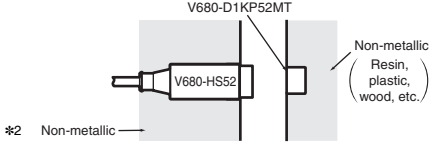

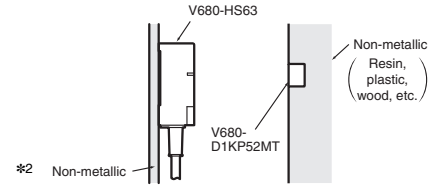

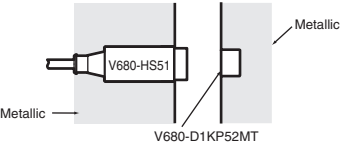
## AC Adapter (for V680-CH1D)

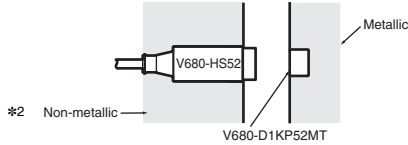
Item	Model	V600-A22
Input voltage	100 to 120 VAC at 50/60 Hz	
Input current	AC: 300 mA (at load current of 2.0 A)	
Output voltage	DC5V $\pm$ 0.25V	
Ambient operating temperature	0 to +40°C	
Ambient storage temperature	-20 to +85°C (with no icing)	
Ambient operating humidity	5% to 95% (with no condensation)	
Insulation resistance	100 M $\Omega$ min. (at 500 VDC) between input terminals and output terminals	
Dielectric strength	2,000 V for 1 minute between input terminals and output terminals with a current leakage of 10 mA max.	
Weight	Approx. 70 g	
Applicable standards	UL	

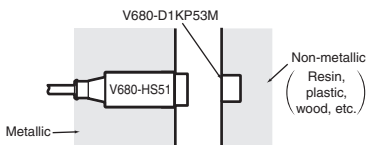

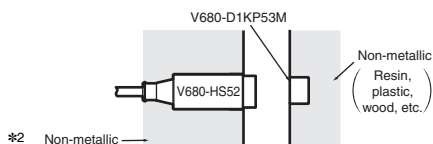
## Communication Specifications

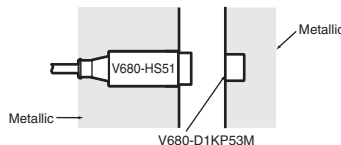

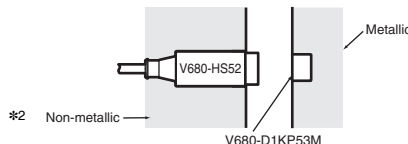









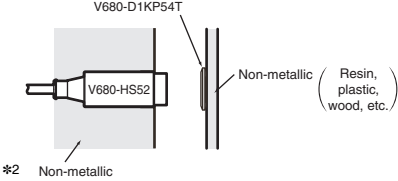

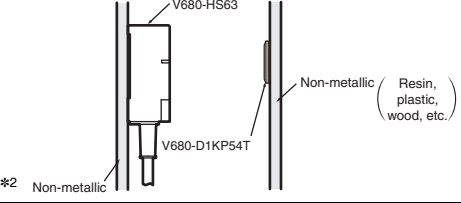
### ID Controllers (V680-CA5D0□-V2, NX-V680C1/C2, CJ1W-V680C11/C12, CS1W-V680C11/C12) RF Tag (1-kbyte Memory) Communication

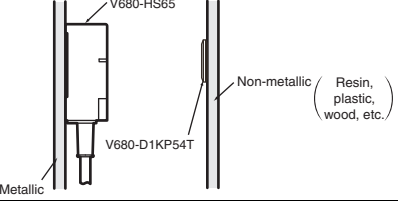
Recommended combination		Function	Communication range (unit: mm)	RF Tag and Antenna mounting conditions
RF Tag	Antenna			
	<b>V680-HS51</b> 	Read distance	0.5 to 6.5 (axis offset ±2)	
		Write distance	0.5 to 6.0 (axis offset ±2)	
	<b>V680-HS52</b> 	Read distance	0 to 9.0 (axis offset ±2)	
		Write distance	0 to 8.5 (axis offset ±2)	
	<b>V680-HS63</b> 	Read distance	0 to 12.0 (axis offset ±2)	
		Write distance	0 to 9.5 (axis offset ±2)	
<b>V680-D1KP52MT</b> (embedded in metallic surface: steel) 	<b>V680-HS51</b> 	Read distance	0.5 to 3.5 *1 (axis offset ±2)	
		Write distance	0.5 to 3.0 *1 (axis offset ±2)	
	<b>V680-HS52</b> 	Read distance	0 to 4.5 *1 (axis offset ±2)	
		Write distance	0 to 4.0 *1 (axis offset ±2)	
<b>V680-D1KP53M</b> 	<b>V680-HS51</b> 	Read distance	0.5 to 6.5 (axis offset ±2)	
		Write distance	0.5 to 6.0 (axis offset ±2)	
	<b>V680-HS52</b> 	Read distance	0 to 9.0 (axis offset ±2)	
		Write distance	0 to 8.5 (axis offset ±2)	
<b>V680-D1KP53M</b> (embedded in metallic surface : steel) 	<b>V680-HS51</b> 	Read distance	0.5 to 3.5 *1 (axis offset ±2)	
		Write distance	0.5 to 3.0 *1 (axis offset ±2)	
	<b>V680-HS52</b> 	Read distance	0 to 4.5 *1 (axis offset ±2)	
		Write distance	0 to 4.0 *1 (axis offset ±2)	

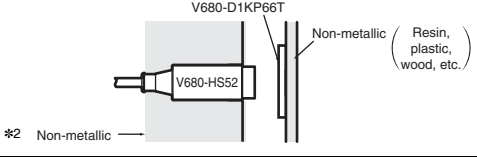
\*1. When using the V680-D1KP52MT/-D1KP53M embedded in metal, use the V680-HS51/-HS52 Antenna. Communications will not be possible with a V680-HS63 Antenna.

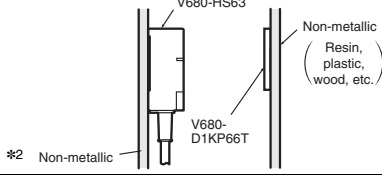
\*2. The Antenna can be mounted in metal, but the communications distance will decrease compared to mounting in nonmetal. Confirm performance using the actual devices before actual operation.

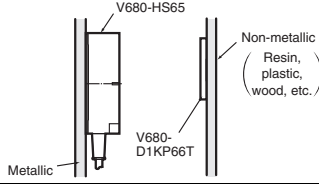
# V680 Series

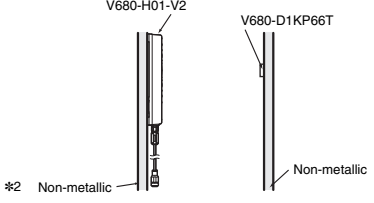
Recommended combination		Function	Communication range (unit: mm)	RF Tag and Antenna mounting conditions	
RF Tag	Antenna				
	<b>V680-HS52</b> 	Read distance	0 to 17.0 *1 (axis offset ±2)		
		Write distance	0 to 15.0 *1 (axis offset ±2)		
	<b>V680-HS63</b> 	Read distance	0 to 24.0 *1 (axis offset ±10)		
		Write distance	0 to 20.0 *1 (axis offset ±10)		
	<b>V680-HS65</b> 	Read distance	0 to 33.0 *1 (axis offset ±10)		
		Write distance	0 to 28.0 *1 (axis offset ±10)		
		<b>V680-HS52</b> 	Read distance	0 to 17.0 *1 (axis offset ±2)	
			Write distance	0 to 17.0 *1 (axis offset ±2)	
		<b>V680-HS63</b> 	Read distance	0 to 30.0 *1 (axis offset ±10)	
Write distance			0 to 25.0 *1 (axis offset ±10)		
<b>V680-HS65</b> 		Read distance	0 to 47.0 *1 (axis offset ±10)		
		Write distance	0 to 42.0 *1 (axis offset ±10)		
<b>V680-H01-V2</b> 		Read distance	0 to 100.0 *1 (axis offset ±2)		
		Write distance	0 to 100.0 *1 (axis offset ±2)		









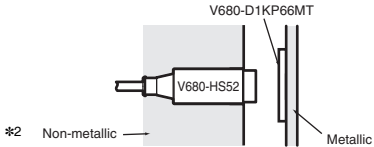

**Note:** When mounting the V680-HS65, be sure to attach the Mounting Brackets at the base of the Antenna.

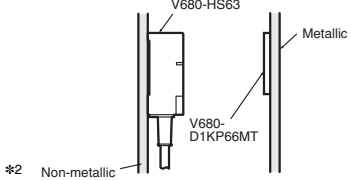
The enclosed Mounting Brackets do not need to be used, however, if the mounting brackets on the Antenna are metal plates and their dimensions are larger than the dimensions of the Antenna (100 × 100 mm).

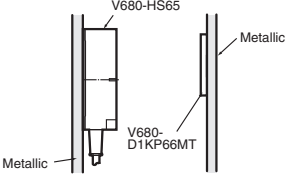
For details, refer to the User's Manual (Cat. No. Z248 or Z262).

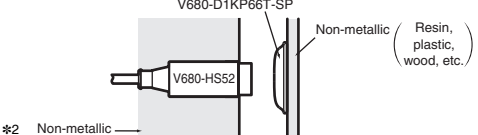
\*1. The communication range may be reduced if the V680-D1KP66T/D1KP54T is mounted onto a metallic surface. Refer to the User's Manual (Cat. No. Z262) for details.

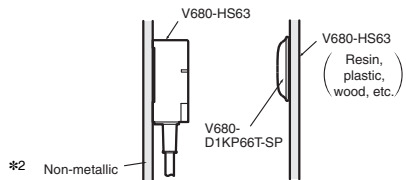

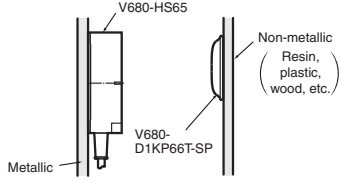
\*2. The Antenna can be mounted in metal, but the communication range will decrease compared to mounting in nonmetal. Confirm performance using the actual devices before actual operation.

Recommended combination		Function	Communication range (unit: mm)	RF Tag and Antenna mounting conditions	
RF Tag	Antenna				
<b>V680-D1KP66MT</b> (flush-mounted on metallic surface: steel)	<b>V680-HS52</b> 	Read distance	0 to 16.0 (axis offset ±2)		
		Write distance	0 to 14.0 (axis offset ±2)		
		<b>V680-HS63</b> 	Read distance	0 to 25.0 (axis offset ±10)	
			Write distance	0 to 20.0 (axis offset ±10)	
		<b>V680-HS65</b> 	Read distance	0 to 25.0 (axis offset ±10)	
			Write distance	0 to 20.0 (axis offset ±10)	
<b>V680-D1KP66T-SP</b>	<b>V680-HS52</b> 	Read distance	0 to 15.0 *1 (axis offset ±2)		
		Write distance	0 to 15.0 *1 (axis offset ±2)		
		<b>V680-HS63</b> 	Read distance	0 to 25.0 *1 (axis offset ±10)	
			Write distance	0 to 20.0 *1 (axis offset ±10)	
		<b>V680-HS65</b> 	Read distance	0 to 42.0 *1 (axis offset ±10)	
			Write distance	0 to 37.0 *1 (axis offset ±10)	

**Note:** When mounting the V680-HS65, be sure to attach the Mounting Brackets at the base of the Antenna. The enclosed Mounting Brackets do not need to be used, however, if the mounting brackets on the Antenna are metal plates and their dimensions are larger than the dimensions of the Antenna (100 × 100 mm). For details, refer to the User's Manual (Cat. No. Z248 or Z262).



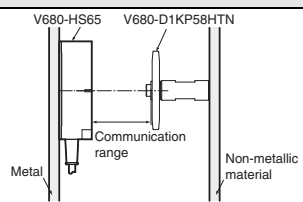

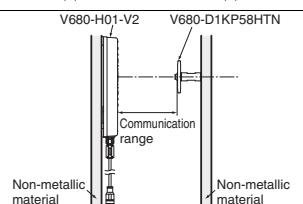







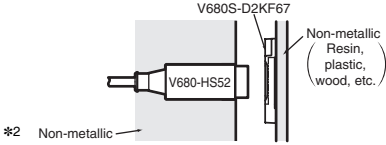

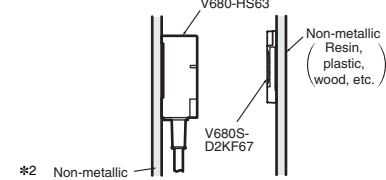
- \*1. The communication range may be reduced if the V680-D1KP66T-SP is mounted onto a metallic surface. Refer to the User's Manual (Cat. No. Z262) for details.
- \*2. The Antenna can be mounted in metal, but the communications distance will decrease compared to mounting in nonmetal. Confirm performance using the actual devices before actual operation.

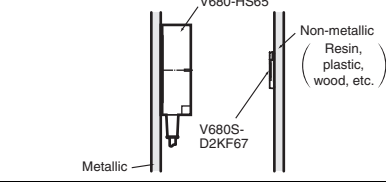
**High-temperature RF Tag (1-kbyte Memory) Communication**

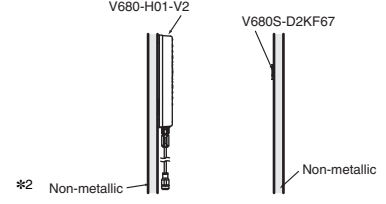
Recommended combination		Function	Communication range (unit: mm)	RF Tag and Antenna mounting conditions	
RF Tag	Antenna				
<b>V680-D1KP58HTN</b>	<b>V680-HS65</b> 	Read distance	0 to 55 (axis offset ±10)		
		Write distance	0 to 55 (axis offset ±10)		
		<b>V680-H01-V2</b> 	Read distance	0 to 150.0 (axis offset ±10)	
			Write distance	0 to 150.0 (axis offset ±10)	

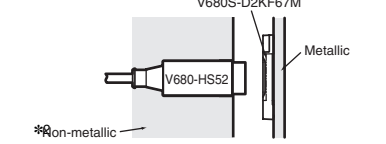
# V680 Series

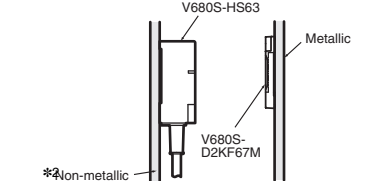
## RF Tag (2-kbyte Memory) Communication

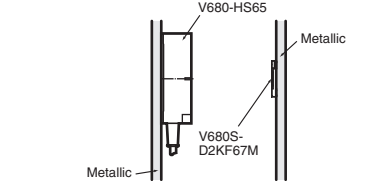
Recommended combination		Function	Communication range (unit: mm)	RF Tag and Antenna mounting conditions
RF Tag	Antenna			
 <b>V680S-D2KF67</b>	 <b>V680-HS52</b>	Read distance	0 to 17.0 *1 (axis offset ±2)	 *2 Non-metallic
		Write distance	0 to 17.0 *1 (axis offset ±2)	
	 <b>V680-HS63</b>	Read distance	7.0 to 30.0 *1 (axis offset ±10)	 *2 Non-metallic
		Write distance	7.0 to 30.0 *1 (axis offset ±10)	
 <b>V680-HS65</b>	Read distance	0 to 42.0 *1 (axis offset ±10)	 *2 Non-metallic	
	Write distance	0 to 42.0 *1 (axis offset ±10)		
 <b>V680-H01-V2</b>	Read distance	0 to 100.0 *1 (axis offset ±10)	 *2 Non-metallic	
	Write distance	0 to 100.0 *1 (axis offset ±10)		
 <b>V680S-D2KF67M</b> (flush-mounted on metallic surface: steel)	 <b>V680-HS52</b>	Read distance	0 to 16.0 (axis offset ±2)	 *2 Non-metallic
		Write distance	0 to 16.0 (axis offset ±2)	
	 <b>V680-HS63</b>	Read distance	6.0 to 25.0 (axis offset ±10)	 *2 Non-metallic
Write distance		6.0 to 25.0 (axis offset ±10)		
 <b>V680-HS65</b>	Read distance	0 to 25.0 (axis offset ±10)	 *2 Non-metallic	
	Write distance	0 to 25.0 (axis offset ±10)		

**Note:** When mounting the V680-HS65, be sure to attach the Mounting Brackets at the base of the Antenna.













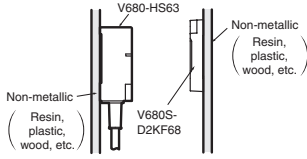

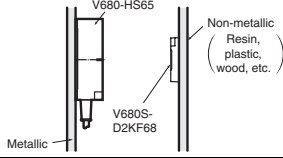

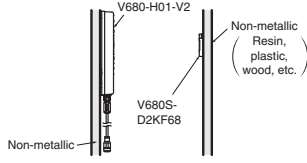

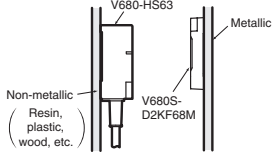

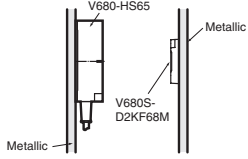
The enclosed Mounting Brackets do not need to be used, however, if the mounting brackets on the Antenna are metal plates and their dimensions are larger than the dimensions of the Antenna (100 × 100 mm).

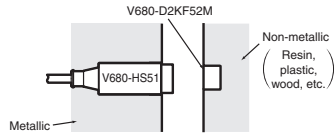
For details, refer to the User's Manual (Cat. No. Z248 or Z262).

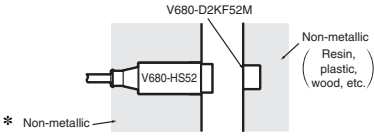
\*1. The communication range may be reduced if the V680S-D2KF67 is mounted onto a metallic surface. Refer to the User's Manual (Cat. No. Z248) for details.

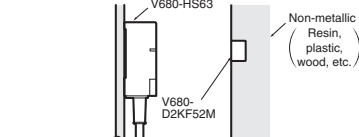
\*2. The Antenna can be mounted in metal, but the communications distance will decrease compared to mounting in nonmetal.

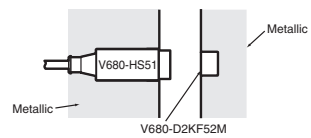
Confirm performance using the actual devices before actual operation.

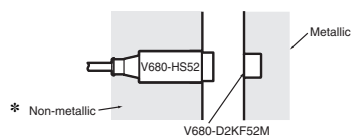











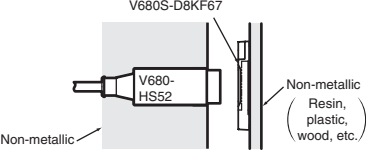

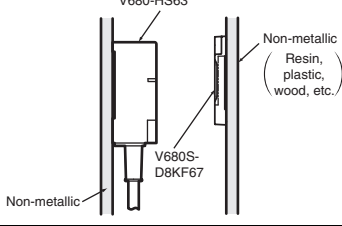
Recommended combination		Function	Communication range (unit: mm)	RF Tag and Antenna mounting conditions
RF Tag	Antenna			
	<b>V680-HS63</b> 	Read distance	0 to 45.0 (axis offset ±10)	
		Write distance	0 to 45.0 (axis offset ±10)	
	<b>V680-HS65</b> 	Read distance	0 to 75.0 (axis offset ±10)	
		Write distance	0 to 75.0 (axis offset ±10)	
	<b>V680-H01-V2</b> 	Read distance	0 to 150.0 (axis offset ±10)	
		Write distance	0 to 150.0 (axis offset ±10)	
	<b>V680-HS63</b> 	Read distance	0 to 35.0 (axis offset ±10)	
		Write distance	0 to 35.0 (axis offset ±10)	
	<b>V680-HS65</b> 	Read distance	0 to 55.0 (axis offset ±10)	
		Write distance	0 to 55.0 (axis offset ±10)	
	<b>V680-HS51</b> 	Read distance	0.5 to 5.5 (axis offset ±2)	
		Write distance	0.5 to 5.5 (axis offset ±2)	
	<b>V680-HS52</b> 	Read distance	0 to 8.0 (axis offset ±2)	
		Write distance	0 to 8.0 (axis offset ±2)	
	<b>V680-HS63</b> 	Read distance	0 to 9.5 (axis offset ±2)	
		Write distance	0 to 9.5 (axis offset ±2)	
	<b>V680-HS51</b> 	Read distance	0 to 3.5 (axis offset ±2)	
		Write distance	0 to 3.5 (axis offset ±2)	
	<b>V680-HS52</b> 	Read distance	0 to 3.0 (axis offset ±2)	
		Write distance	0 to 3.0 (axis offset ±2)	

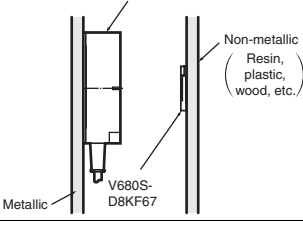
**Note:** When mounting the V680-HS65, be sure to attach the Mounting Brackets at the base of the Antenna. The enclosed Mounting Brackets do not need to be used, however, if the mounting brackets on the Antenna are metal plates and their dimensions are larger than the dimensions of the Antenna (100 × 100 mm). For details, refer to the User's Manual (Cat. No. Z248 or Z262).

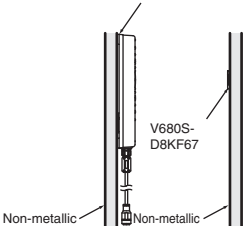
\* The Antenna can be mounted in metal, but the communications distance will decrease compared to mounting in nonmetal. Confirm performance using the actual devices before actual operation.

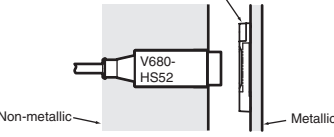

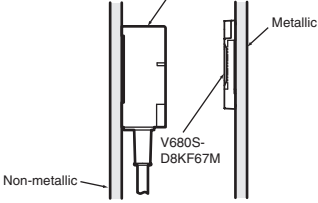

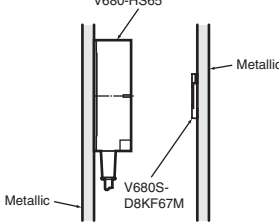



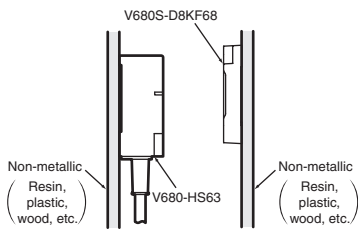

# V680 Series

## RF Tag (8-kbyte Memory) Communication

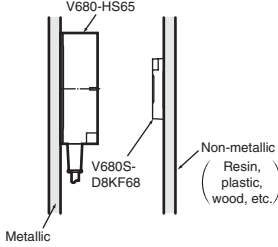
Recommended combination		Function	Communication range (unit: mm)	RF Tag and Antenna mounting conditions
RF Tag	Reader Writer			
	<b>V680-HS52</b> 	Read distance	0 to 17.0 (axis offset ±2)	
		Write distance	0 to 17.0 (axis offset ±2)	
	<b>V680-HS63</b> 	Read distance	7.0 to 30.0 (axis offset ±10)	
		Write distance	7.0 to 30.0 (axis offset ±10)	
	<b>V680-HS65</b> 	Read distance	0 to 42.0 (axis offset ±10)	
	Write distance	0 to 42.0 (axis offset ±10)		
	<b>V680-H01-V2</b> 	Read distance	0 to 100.0 (axis offset ±10)	
		Write distance	0 to 100.0 (axis offset ±10)	
	<b>V680-HS52</b> 	Read distance	0 to 16.0 (axis offset ±2)	
		Write distance	0 to 16.0 (axis offset ±2)	
	<b>V680-HS63</b> 	Read distance	6.0 to 25.0 (axis offset ±10)	
		Write distance	6.0 to 25.0 (axis offset ±10)	
	<b>V680-HS65</b> 	Read distance	0 to 25.0 (axis offset ±10)	
		Write distance	0 to 25.0 (axis offset ±10)	

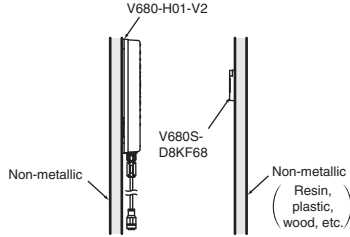
**Note:** When mounting the V680-HS65, be sure to attach the Mounting Brackets at the base of the Antenna.

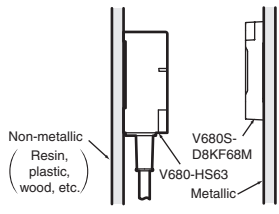

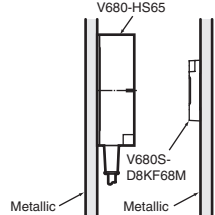





The enclosed Mounting Brackets do not need to be used, however, if the mounting brackets on the Antenna are metal plates and their dimensions are larger than the dimensions of the Antenna (100 × 100 mm). For details, refer to the User's Manual (Cat. No. Z248 or Z262).

Recommended combination		Function	Communication range (unit: mm)	RF Tag and Antenna mounting conditions
RF Tag	Reader Writer			
	<b>V680-HS63</b> 	Read distance	0 to 45.0 (axis offset ±10)	
		Write distance	0 to 45.0 (axis offset ±10)	
	<b>V680-HS65</b> 	Read distance	0 to 75.0 (axis offset ±10)	
		Write distance	0 to 75.0 (axis offset ±10)	
	<b>V680-H01-V2</b> 	Read distance	0 to 150.0 (axis offset ±10)	
		Write distance	0 to 150.0 (axis offset ±10)	
<b>V680S-D8KF68M</b> 	<b>V680-HS63</b> 	Read distance	0 to 35.0 (axis offset ±10)	
		Write distance	0 to 35.0 (axis offset ±10)	
	<b>V680-HS65</b> 	Read distance	0 to 55.0 (axis offset ±10)	
		Write distance	0 to 55.0 (axis offset ±10)	

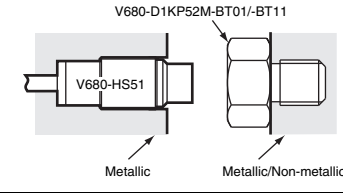
**Note:** When mounting the V680-HS65, be sure to attach the Mounting Brackets at the base of the Antenna.  
 The enclosed Mounting Brackets do not need to be used, however, if the mounting brackets on the Antenna are metal plates and their dimensions are larger than the dimensions of the Antenna (100 × 100 mm).  
 For details, refer to the User's Manual (Cat. No. Z248 or Z262).

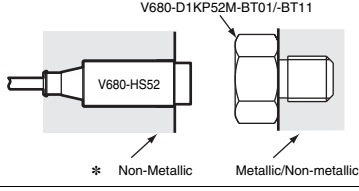
# V680 Series

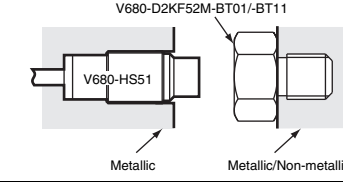











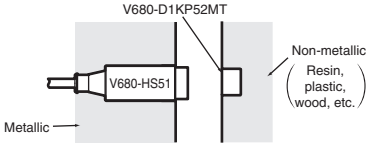

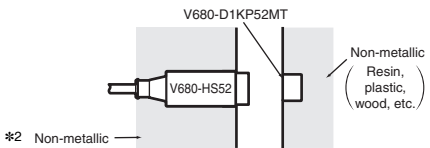

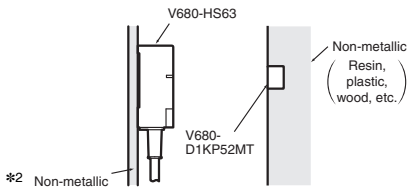

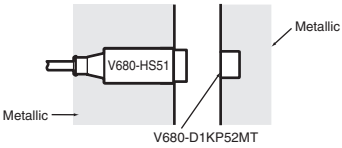
## Bolt RF Tag (1-kbyte or 2-kbyte Memory) Communication

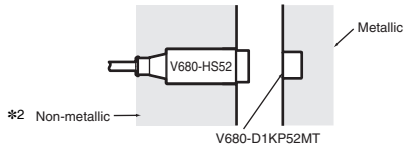
Recommended combination		Function	Communication range (unit: mm)	RF Tag and Antenna mounting conditions
RF Tag	Antenna			
<b>V680-D1KP52M-BT01/-BT11</b> 	<b>V680-HS51</b> 	Read distance	0.5 to 2.5 (axis offset ±2)	
		Write distance	0.5 to 2.0 (axis offset ±2)	
	<b>V680-HS52</b> 	Read distance	0.5 to 3.0 (axis offset ±2)	
		Write distance	0.5 to 2.5 (axis offset ±2)	
<b>V680-D2KF52M-BT01/-BT11</b> 	<b>V680-HS51</b> 	Read distance	0.5 to 2.5 (axis offset ±2)	
		Write distance	0.5 to 2.5 (axis offset ±2)	
	<b>V680-HS52</b> 	Read distance	0.5 to 2.0 (axis offset ±2)	
		Write distance	0.5 to 2.0 (axis offset ±2)	

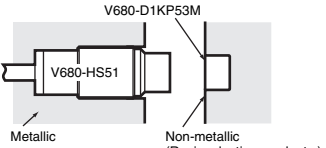

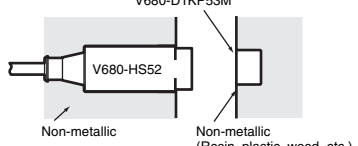

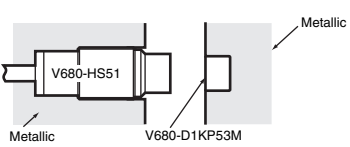

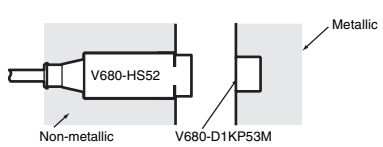
\* Mounting can be performed in metal, but the communications distance will decrease compared to mounting in nonmetal. Confirm performance using the actual devices before actual operation.

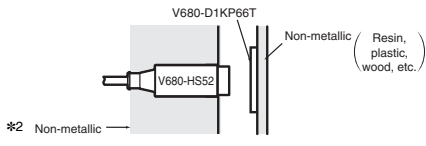

**DeviceNet ID Slave (V680-HAM42-DRT)  
PROFIBUS ID Slave (V680-HAM42-PRT)  
ID Flag Sensors (V680-HAM91/-HAM81)  
RF Tag (1-kbyte Memory) Communication**

Recommended combination		Function	Communication range (unit: mm)	RF Tag and Antenna mounting conditions
RF Tag	Antenna			
<b>V680-D1KP52MT</b>  	<b>V680-HS51</b>  	Read distance	0.5 to 6.5 (axis offset ±2)	
		Write distance	0.5 to 6.0 (axis offset ±2)	
	<b>V680-HS52</b>  	Read distance	0.5 to 9.0 (axis offset ±2)	
		Write distance	0.5 to 8.5 (axis offset ±2)	
	<b>V680-HS63</b>  	Read distance	0.5 to 12.0 (axis offset ±2)	
		Write distance	0.5 to 9.5 (axis offset ±2)	
<b>V680-D1KP52MT</b> (embedded in metallic surface: steel)  	<b>V680-HS51</b>  	Read distance	0.5 to 3.5 (axis offset ±2)	
		Write distance	0.5 to 3.0 (axis offset ±2)	
	<b>V680-HS52</b>  	Read distance	0.5 to 4.5 (axis offset ±2)	
		Write distance	0.5 to 4.0 (axis offset ±2)	
<b>V680-D1KP53M</b>  	<b>V680-HS51</b>  	Read distance	0.5 to 6.5 (axis offset ±2)	
		Write distance	0.5 to 6.0 (axis offset ±2)	
	<b>V680-HS52</b>  	Read distance	0.5 to 9.0 (axis offset ±2)	
		Write distance	0.5 to 8.5 (axis offset ±2)	
<b>V680-D1KP53M</b> (embedded in metallic surface : steel)  	<b>V680-HS51</b>  	Read distance	0.5 to 3.5 (axis offset ±2)	
		Write distance	0.5 to 3.0 (axis offset ±2)	
	<b>V680-HS52</b>  	Read distance	0.5 to 4.5 (axis offset ±2)	
		Write distance	0.5 to 4.0 (axis offset ±2)	

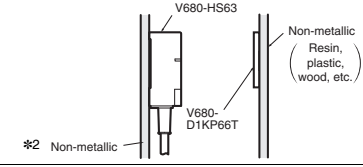
# V680 Series

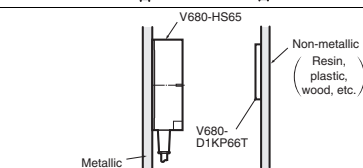
Recommended combination		Function	Communication range (unit: mm)	RF Tag and Antenna mounting conditions
RF Tag	Antenna			
<b>V680-D1KP66T</b>  	<b>V680-HS52</b> 	Read distance	1.0 to 17.0 *1 (axis offset ±2)	
		Write distance	1.0 to 17.0 *1 (axis offset ±2)	
	<b>V680-HS63</b> 	Read distance	5.0 to 30.0 *1 (axis offset ±10)	
		Write distance	5.0 to 25.0 *1 (axis offset ±10)	
	<b>V680-HS65</b> 	Read distance	5.0 to 47.0 *1 (axis offset ±10)	
		Write distance	5.0 to 42.0 *1 (axis offset ±10)	











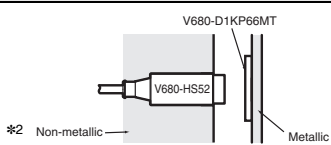

**Note:** When mounting the V680-HS65, be sure to attach the Mounting Brackets at the base of the Antenna.

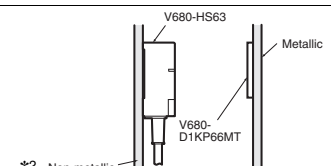
The enclosed Mounting Brackets do not need to be used, however, if the mounting brackets on the Antenna are metal plates and their dimensions are larger than the dimensions of the Antenna (100 × 100 mm).

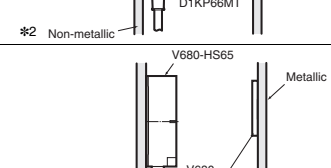
For details, refer to the User's Manual (Cat. No. Z278 or Z279).

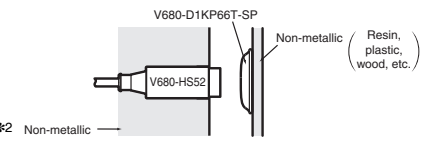
\*1. The communication range may be reduced if the V680-D1KP66T is mounted onto a metallic surface. Refer to the User's Manual (Cat. No. Z278 or Z279) for details.

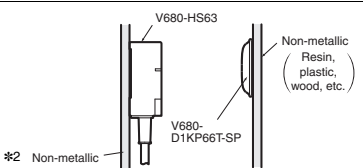
\*2. The Antenna can be mounted in metal, but the communications distance will decrease compared to mounting in nonmetal.

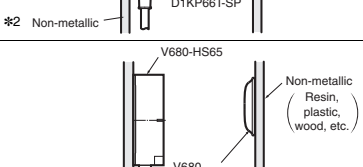
Recommended combination		Function	Communication range (unit: mm)	RF Tag and Antenna mounting conditions	
RF Tag	Antenna				
<b>V680-D1KP66MT</b> (flush-mounted on metallic surface: steel)  	<b>V680-HS52</b> 	Read distance	1.0 to 16.0 (axis offset ±2)		
		Write distance	1.0 to 14.0 (axis offset ±2)		
	<b>V680-HS63</b> 	Read distance	5.0 to 25.0 (axis offset ±2)		
		Write distance	5.0 to 20.0 (axis offset ±2)		
	<b>V680-HS65</b> 	Read distance	5.0 to 25.0 (axis offset ±10)		
		Write distance	5.0 to 20.0 (axis offset ±10)		
	<b>V680-D1KP66T-SP</b>  	<b>V680-HS52</b> 	Read distance	1.0 to 15.0 *1 (axis offset ±2)	
			Write distance	1.0 to 15.0 *1 (axis offset ±2)	
		<b>V680-HS63</b> 	Read distance	5.0 to 25.0 *1 (axis offset ±10)	
Write distance			5.0 to 20.0 *1 (axis offset ±10)		
<b>V680-HS65</b> 		Read distance	5.0 to 42.0 *1 (axis offset ±10)		
		Write distance	5.0 to 37.0 *1 (axis offset ±10)		

**Note:** When mounting the V680-HS65, be sure to attach the Mounting Brackets at the base of the Antenna.

The enclosed Mounting Brackets do not need to be used, however, if the mounting brackets on the Antenna are metal plates and their dimensions are larger than the dimensions of the Antenna (100 × 100 mm).













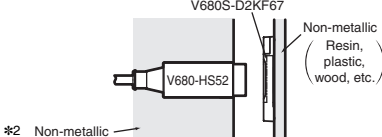

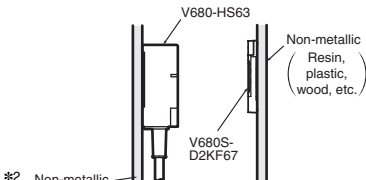

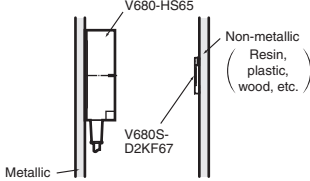
For details, refer to the User's Manual (Cat. No. Z278 or Z279).

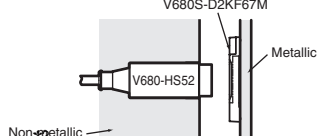
\*1. The communication range may be reduced if the V680-D1KP66T-SP is mounted onto a metallic surface. Refer to the User's Manual (Cat. No. Z278 or Z279) for details.

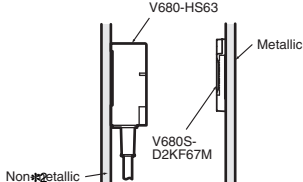
\*2. The Antenna can be mounted in metal, but the communications distance will decrease compared to mounting in nonmetal.

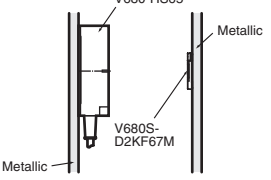

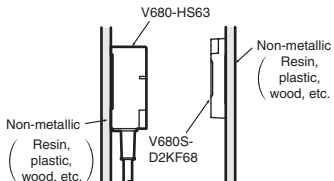

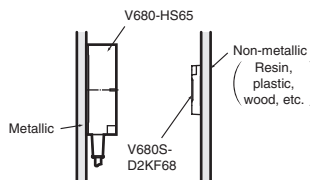







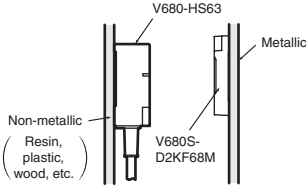

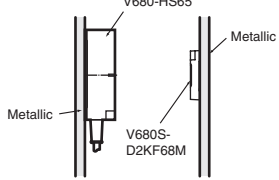
Confirm performance using the actual devices before actual operation.

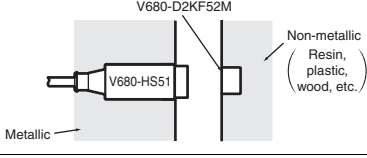
RF Tag (2-kbyte Memory) Communication

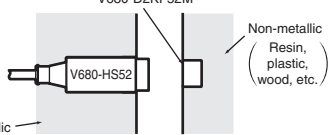
Recommended combination		Function	Communication range (unit: mm)	RF Tag and Antenna mounting conditions
RF Tag	Antenna			
	<b>V680-HS52</b> 	Read distance	1.0 to 17.0 *1 (axis offset ±2)	
		Write distance	1.0 to 17.0 *1 (axis offset ±2)	
	<b>V680-HS63</b> 	Read distance	7.0 to 30.0 *1 (axis offset ±10)	
		Write distance	7.0 to 30.0 *1 (axis offset ±10)	
	<b>V680-HS65</b> 	Read distance	5.0 to 42.0 *1 (axis offset ±10)	
		Write distance	5.0 to 42.0 *1 (axis offset ±10)	
<b>V680S-D2KF67M</b> (flush-mounted on metallic surface: steel)	<b>V680-HS52</b> 	Read distance	1.0 to 16.0 (axis offset ±2)	
		Write distance	1.0 to 16.0 (axis offset ±2)	
	<b>V680-HS63</b> 	Read distance	6.0 to 25.0 (axis offset ±10)	
		Write distance	6.0 to 25.0 (axis offset ±10)	
	<b>V680-HS65</b> 	Read distance	5.0 to 25.0 (axis offset ±10)	
		Write distance	5.0 to 25.0 (axis offset ±10)	
<b>V680S-D2KF68</b> 	<b>V680-HS63</b> 	Read distance	5.0 to 45.0 (axis offset ±10)	
		Write distance	5.0 to 45.0 (axis offset ±10)	
	<b>V680-HS65</b> 	Read distance	5.0 to 75.0 (axis offset ±10)	
		Write distance	5.0 to 75.0 (axis offset ±10)	

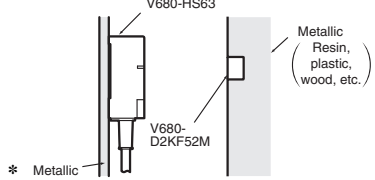

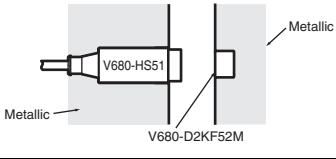

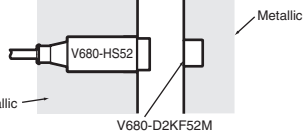







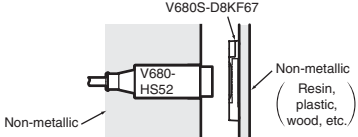

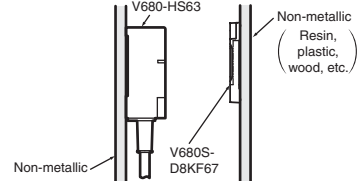

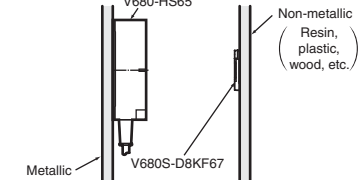
**Note:** When mounting the V680-HS65, be sure to attach the Mounting Brackets at the base of the Antenna.  
 The enclosed Mounting Brackets do not need to be used, however, if the mounting brackets on the Antenna are metal plates and their dimensions are larger than the dimensions of the Antenna (100 × 100 mm).  
 For details, refer to the User's Manual (Cat. No. Z278 or Z279).  
 \*1. The communication range may be reduced if the V680S-D2KF67 is mounted onto a metallic surface. Refer to the User's Manual (Cat. No. Z278 or Z279) for details.  
 \*2. The Antenna can be mounted in metal, but the communications distance will decrease compared to mounting in nonmetal.  
 Confirm performance using the actual devices before actual operation.

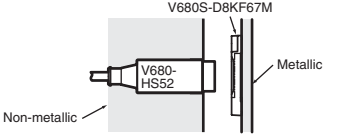
# V680 Series

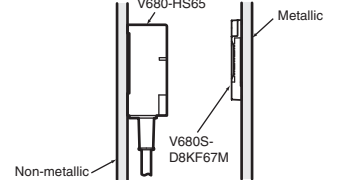

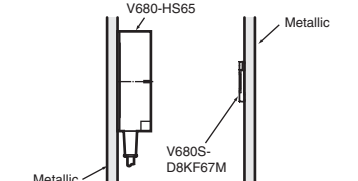

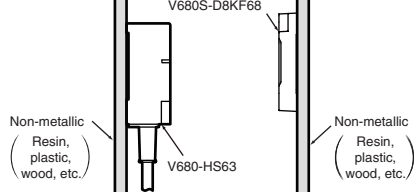
Recommended combination		Function	Communication range (unit: mm)	RF Tag and Antenna mounting conditions
RF Tag	Antenna			
V680S-D2KF68M 	V680-HS63 	Read distance	5.0 to 35.0 (axis offset ±10)	
	Write distance	5.0 to 35.0 (axis offset ±10)		
	V680-HS65 	Read distance	5.0 to 55.0 (axis offset ±10)	
	Write distance	5.0 to 55.0 (axis offset ±10)		
V680-D2KF52M 	V680-HS51 	Read distance	0.5 to 5.5 (axis offset ±2)	
	Write distance	0.5 to 5.5 (axis offset ±2)		
	V680-HS52 	Read distance	0.5 to 8.0 (axis offset ±2)	
Write distance	0.5 to 8.0 (axis offset ±2)			
	V680-HS63 	Read distance	0.5 to 9.5 (axis offset ±2)	
	Write distance	0.5 to 9.5 (axis offset ±2)		
V680-D2KF52M (embedded in metallic surface: steel) 	V680-HS51 	Read distance	0.5 to 3.5 (axis offset ±2)	
	Write distance	0.5 to 3.5 (axis offset ±2)		
	V680-HS52 	Read distance	0.5 to 3.0 (axis offset ±2)	
	Write distance	0.5 to 3.0 (axis offset ±2)		

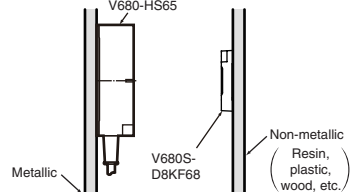
\* The Antenna can be mounted in metal, but the communications distance will decrease compared to mounting in nonmetal. Confirm performance using the actual devices before actual operation.

RF Tag (8-kbyte Memory) Communication



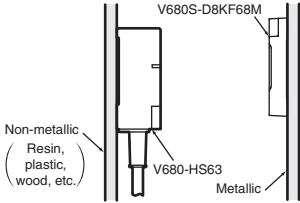

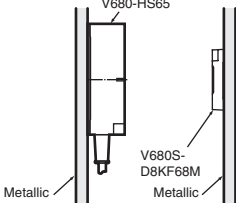



Recommended combination		Function	Communication range (unit: mm)	RF Tag and Antenna mounting conditions
RF Tag	Reader Writer			
<b>V680S-D8KF67</b>  	<b>V680-HS52</b> 	Read distance	1.0 to 17.0 (axis offset $\pm 2$ )	
		Write distance	1.0 to 17.0 (axis offset $\pm 2$ )	
	<b>V680-HS63</b> 	Read distance	7.0 to 30.0 (axis offset $\pm 10$ )	
		Write distance	7.0 to 30.0 (axis offset $\pm 10$ )	
	<b>V680-HS65</b> 	Read distance	5.0 to 42.0 (axis offset $\pm 10$ )	
		Write distance	5.0 to 42.0 (axis offset $\pm 10$ )	
<b>V680S-D8KF67M</b> (flush-mounted on metallic surface: steel)	<b>V680-HS52</b> 	Read distance	1.0 to 16.0 (axis offset $\pm 2$ )	
		Write distance	1.0 to 16.0 (axis offset $\pm 2$ )	
	<b>V680-HS63</b> 	Read distance	6.0 to 25.0 (axis offset $\pm 10$ )	
		Write distance	6.0 to 25.0 (axis offset $\pm 10$ )	
	<b>V680-HS65</b> 	Read distance	5.0 to 25.0 (axis offset $\pm 10$ )	
		Write distance	5.0 to 25.0 (axis offset $\pm 10$ )	
<b>V680S-D8KF68</b>  	<b>V680-HS63</b> 	Read distance	5.0 to 45.0 (axis offset $\pm 10$ )	
		Write distance	5.0 to 45.0 (axis offset $\pm 10$ )	
	<b>V680-HS65</b> 	Read distance	5.0 to 75.0 (axis offset $\pm 10$ )	
		Write distance	5.0 to 75.0 (axis offset $\pm 10$ )	

# V680 Series

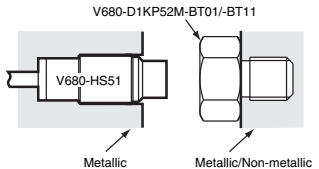
Recommended combination		Function	Communication range (unit: mm)	RF Tag and Antenna mounting conditions
RF Tag	Reader Writer			
		Read distance	5.0 to 35.0 (axis offset ±10)	
		Write distance	5.0 to 35.0 (axis offset ±10)	
		Read distance	5.0 to 55.0 (axis offset ±10)	
		Write distance	5.0 to 55.0 (axis offset ±10)	

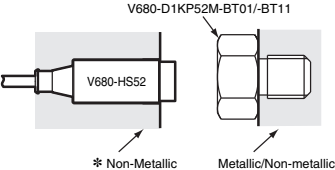
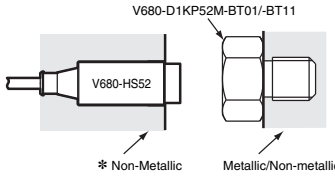
**Note:** When mounting the V680-HS65, be sure to attach the Mounting Brackets at the base of the Antenna. The enclosed Mounting Brackets do not need to be used, however, if the mounting brackets on the Antenna are metal plates and their dimensions are larger than the dimensions of the Antenna (100 × 100 mm). For details, refer to the User's Manual (Cat. No. Z248 or Z262).

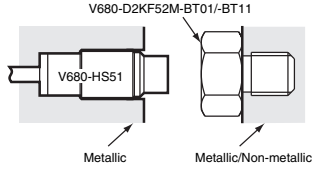
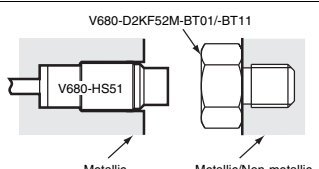
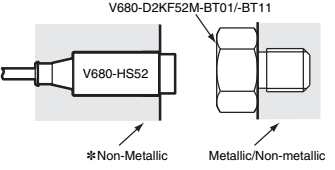
## Bolt RF Tag (1-kbyte or 2-kbyte Memory) Communication

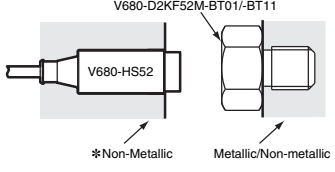
Recommended combination		Function	Communication range (unit: mm)	RF Tag and Antenna mounting conditions
RF Tag	Antenna			
		Read distance	0.5 to 2.5 (axis offset ±2)	
		Write distance	0.5 to 2.0 (axis offset ±2)	
		Read distance	0.5 to 3.0 (axis offset ±2)	
		Write distance	0.5 to 2.5 (axis offset ±2)	
		Read distance	0.5 to 2.5 (axis offset ±2)	
		Write distance	0.5 to 2.5 (axis offset ±2)	
		Read distance	0.5 to 2.0 (axis offset ±2)	
		Write distance	0.5 to 2.0 (axis offset ±2)	

\* Mounting can be performed in metal, but the communications distance will decrease compared to mounting in nonmetal. Confirm performance using the actual devices before actual operation.

## Characteristic Data (for Reference Only)

### Communication range (for Reference Only)

(unit: mm)

**ID Controller (using the V680-CA5D0□-V2, NX-V680C1/C2, CJ1W-V680C11/C12, or CS1W-V680C11/C12)**

#### 1-kbyte Memory RF Tag

The values given for communications ranges are reference values. Refer to pages 17 to 19, 24 for communications distance specifications. The communications distance will depend on the RF Tags, ambient temperature, surrounding metal, noise, and other factors. Test operation completely when installing a system.

**V680-HS52 (embedded in non-metallic material) & V680-D1KP52MT (embedded in non-metallic material)**

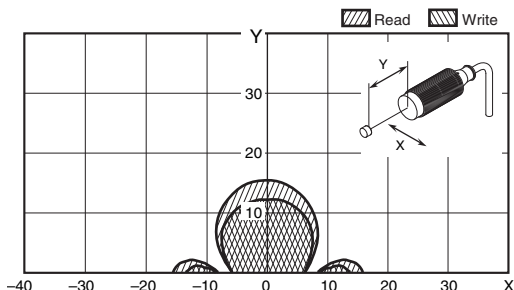

**V680-HS51 (embedded in metallic material) & V680-D1KP52MT (embedded in non-metallic material)**

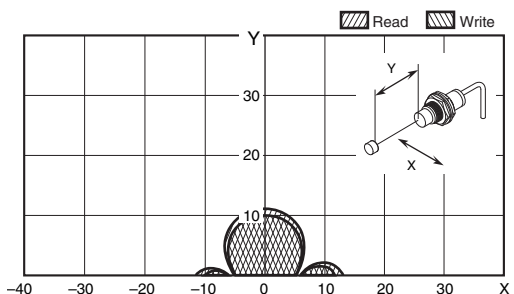

**V680-HS63 (mounted on non-metallic material) & V680-D1KP52MT (embedded in non-metallic material)**

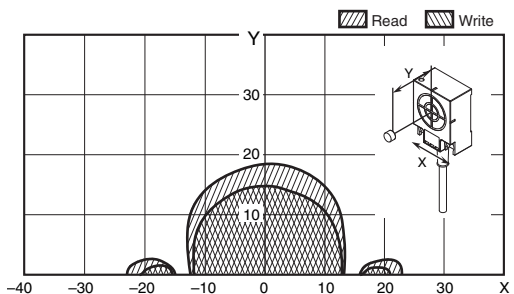

**V680-HS51 (embedded in metallic material) & V680-D1KP53M (embedded in non-metallic material)**

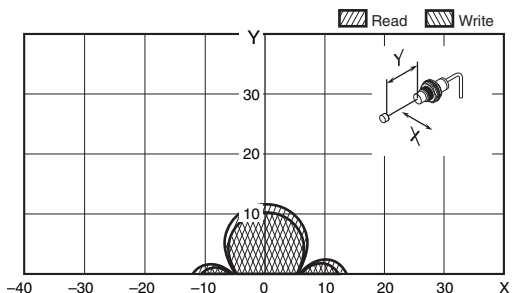

**V680-HS52 (embedded in non-metallic material) & V680-D1KP53M (embedded in non-metallic material)**

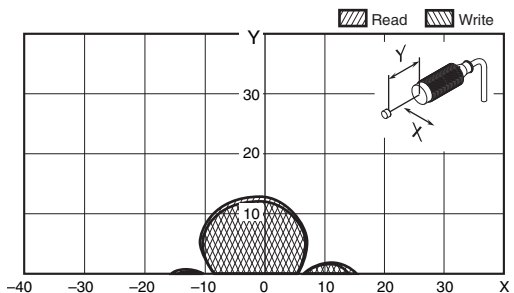

**V680-HS52 (embedded in non-metallic material) & V680-D1KP52MT (embedded in metallic surface: steel)**

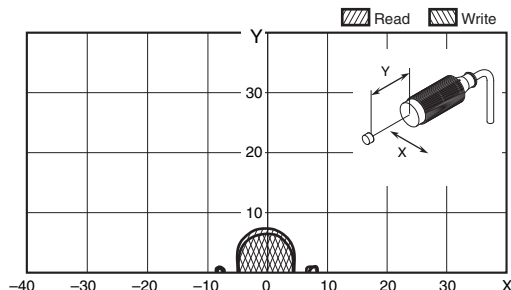

**V680-HS51 (embedded in metallic material) & V680-D1KP52MT (embedded in metallic surface: steel)**

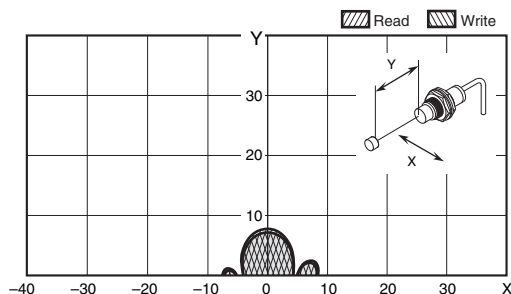

**V680-HS51 (embedded in metallic material) & V680-D1KP53M (embedded in metallic surface: steel)**

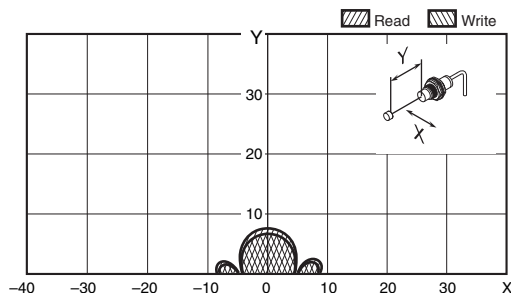

**V680-HS52 (embedded in non-metallic material) & V680-D1KP53M (embedded in metallic surface: steel)**

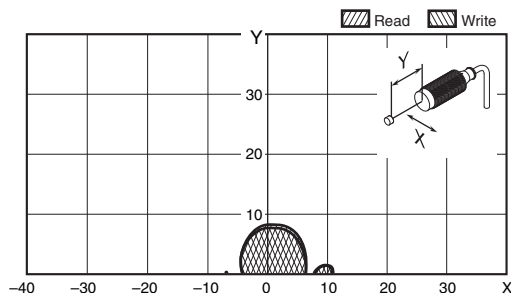

# V680 Series

**V680-HS52 (embedded in non-metallic material) & V680-D1KP54T (mounted on non-metallic material)**

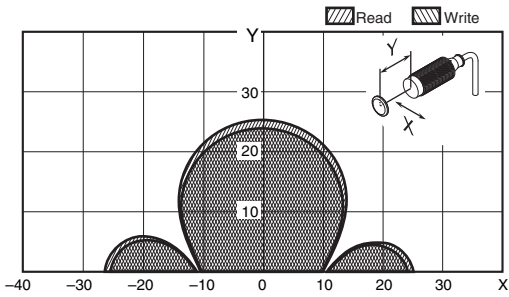

**V680-HS63 (mounted on non-metallic material) & V680-D1KP54T (mounted on non-metallic material)**

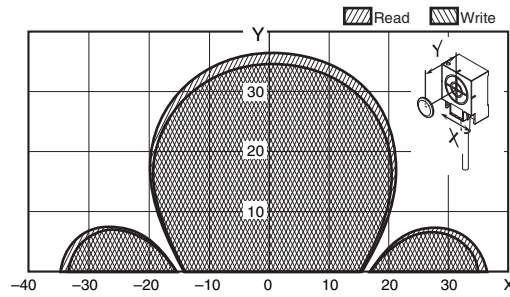

**V680-HS65 (mounted on metallic material) & V680-D1KP54T (mounted on non-metallic material)**

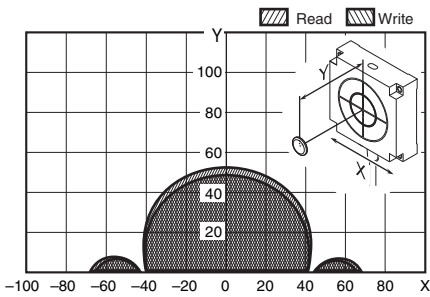

**V680-HS63 (mounted on non-metallic material) & V680-D1KP66T (mounted on non-metallic material)**

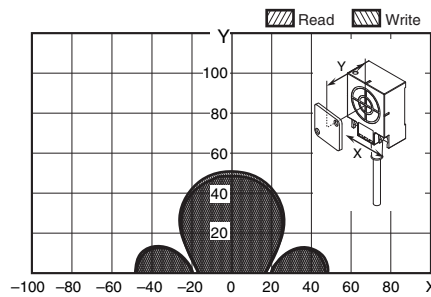

**V680-HS52 (embedded in non-metallic material) & V680-D1KP66T (mounted on non-metallic material)**

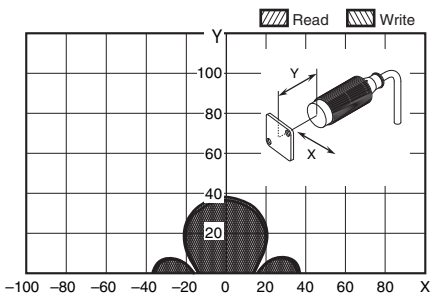

**V680-HS65 (mounted on metallic material) & V680-D1KP66T (mounted on non-metallic material)**

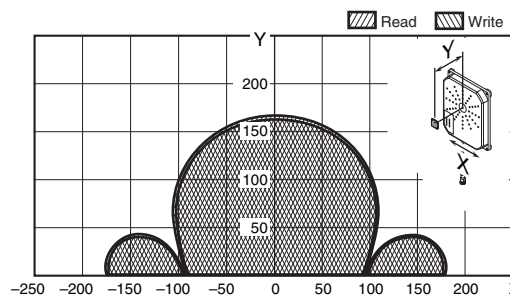

**V680-HS52 (mounted on metallic material) & V680-D1KP66T (mounted on non-metallic material)**

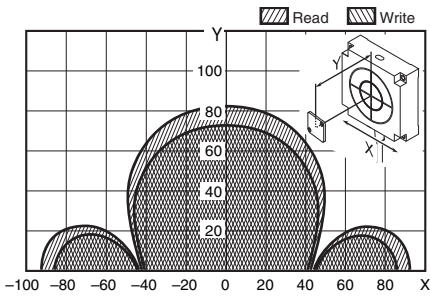

**V680-HS63 (mounted on non-metallic material) & V680-D1KP66T-SP (mounted on non-metallic material)**

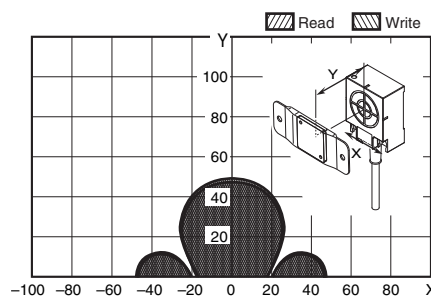

**V680-HS52 (embedded in non-metallic material) & V680-D1KP66T-SP (mounted on non-metallic material)**

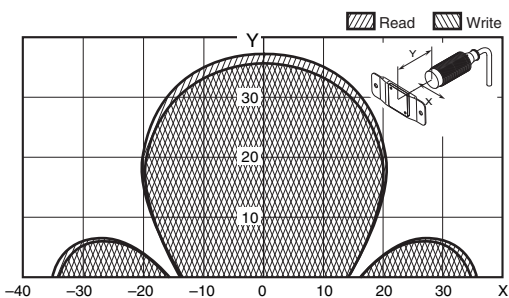



**V680-HS65 (mounted on metallic material) & V680-D1KP66T-SP (mounted on non-metallic material)**

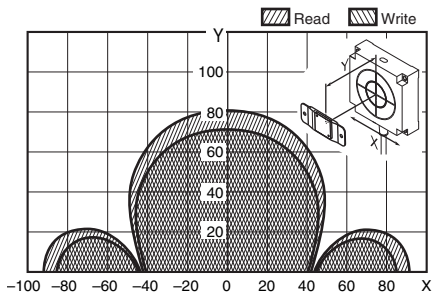

**V680-HS63 (mounted on non-metallic material) & V680-D1KP66MT (mounted on metallic surface: steel)**

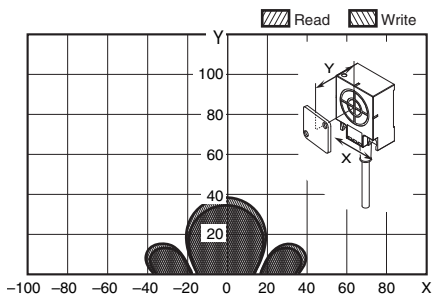

**V680-HS52 (embedded in non-metallic material) & V680-D1KP66MT (mounted on metallic surface: steel)**

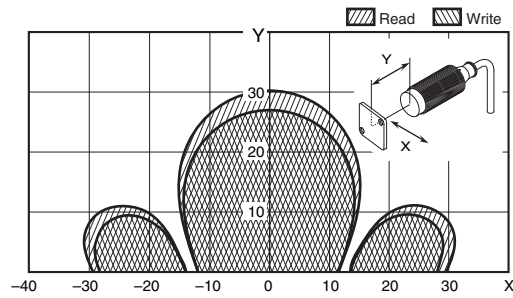

**V680-HS65 (mounted on metallic material) & V680-D1K66MT (mounted on metallic surface: steel)**

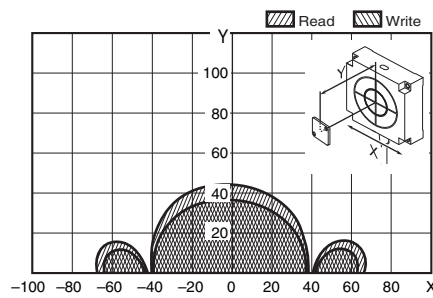

**1-kbyte Memory Bolt RF Tags**

**V680-HS51 (embedded in metallic material) & V680-D1KP52M-BT01 (mounted in metal/non-metallic material)**

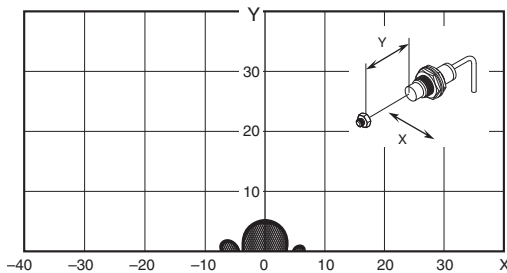

**V680-HS51 (embedded in metallic material) & V680-D1KP52M-BT11 (mounted in metal/non-metallic material)**

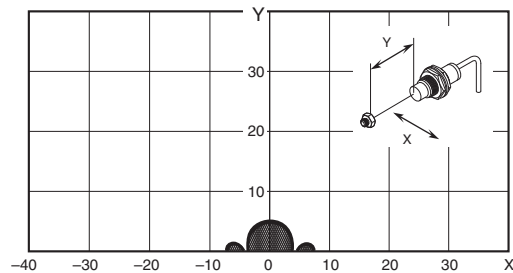

**V680-HS52 (embedded in non-metallic material) & V680-D1KP52M-BT01 (mounted in metal/non-metallic material)**

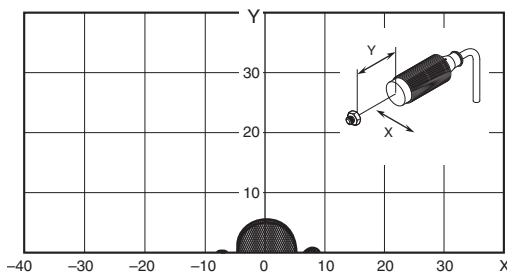

**High-temperature Type 1-kbyte Memory RF Tags**

**V680-HS65 (with metal on back surface) & V680-D1KP58HTN**

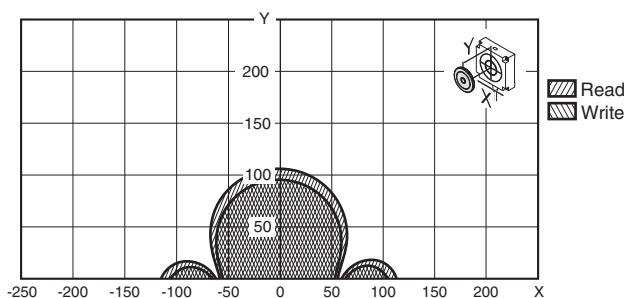

**V680-H01-V2 and V680-D1KP58HTN**

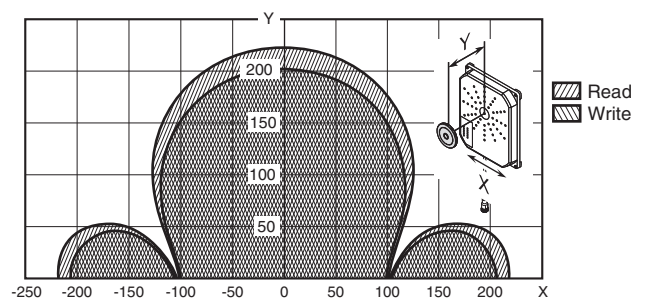

# V680 Series

## 2-kbyte Memory RF Tag

The values given for communications ranges are reference values. Refer to pages 20 to 21, 24 for communications distance specifications. The communications distance will depend on the RF Tags, ambient temperature, surrounding metal, noise, and other factors. Test operation completely when installing a system.

**V680-HS63 (mounted on non-metallic material) & V680S-D2KF67 (mounted on non-metallic material)**

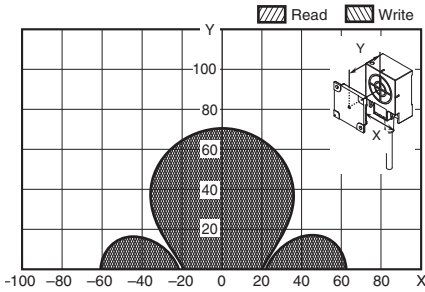

**V680-H01-V2 (mounted on non-metallic material) & V680S-D2KF67 (mounted on non-metallic material)**

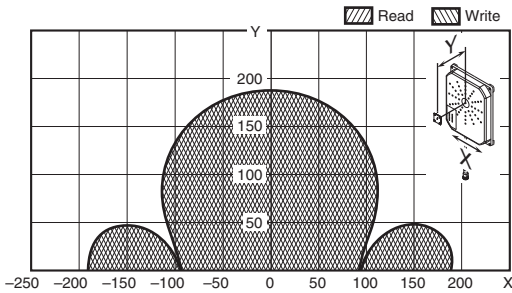

**V680-HS63 (mounted on non-metallic material) & V680S-D2KF67M (mounted on metallic surface: steel)**

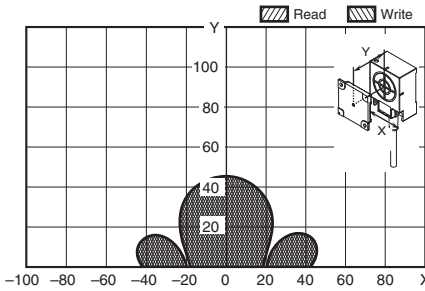

**V680-HS63 (with Metal on Back Surface) & V680S-DKF68 (Tag direction: Horizontal)**

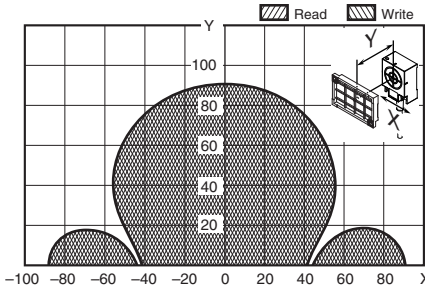

**V680-HS65 (with Metal on Back Surface) & V680S-DKF68 (Tag direction: Horizontal)**

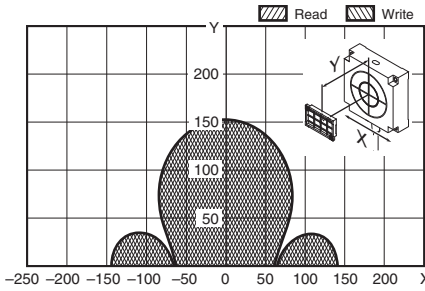

**V680-HS65 (mounted on metallic material) & V680S-D2KF67 (mounted on non-metallic material)**

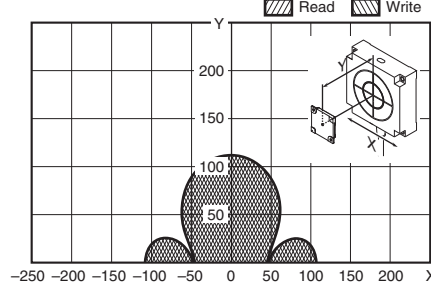

**V680-HS52 (embedded in non-metallic material) & V680S-D2KF67M (mounted on metallic surface: steel)**

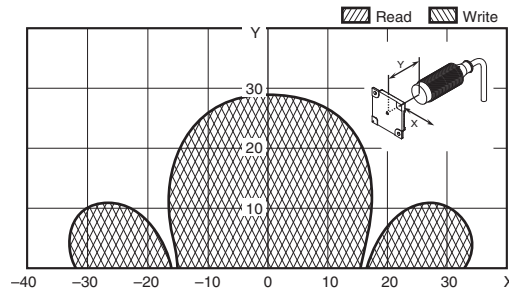

**V680-HS65 (mounted on metallic material) & V680S-D2KF67M (mounted on metallic surface: steel)**

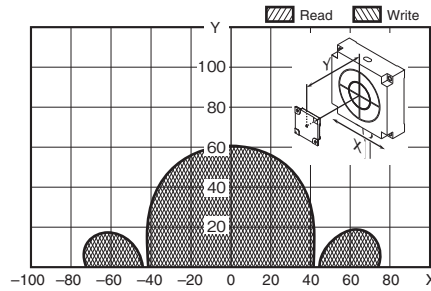

**V680-HS63 (with Metal on Back Surface) & V680S-DKF68 (Tag direction: Vertical)**

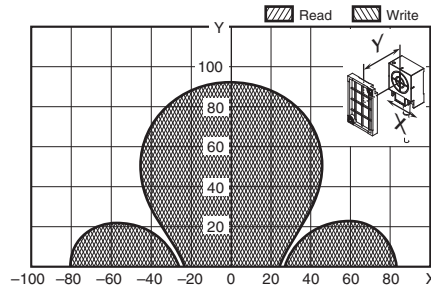

**V680-HS65 (with Metal on Back Surface) & V680S-DKF68 (Tag direction: Vertical)**

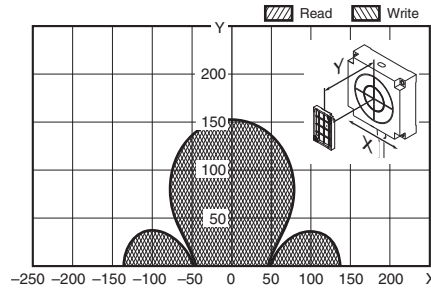

**V680-H01-V2 (with Non-Metal on Back Surface) & V680S-DKF68 (Tag direction: Horizontal)**

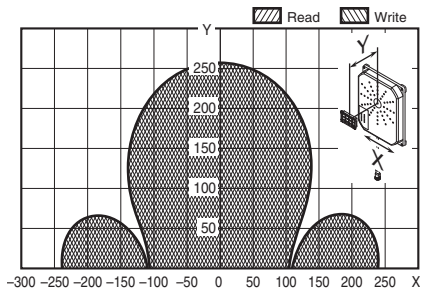

**V680-H01-V2 (with Non-Metal on Back Surface) & V680S-DKF68 (Tag direction: Vertical)**

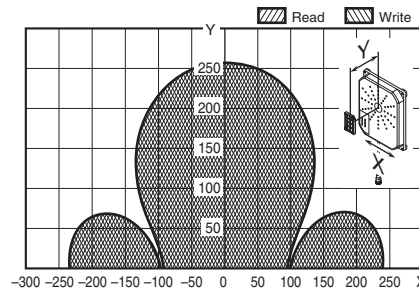

**V680-HS63 (with Metal on Back Surface) & V680S-DKF68 (Metal on back: Steel) (Tag direction: Horizontal)**

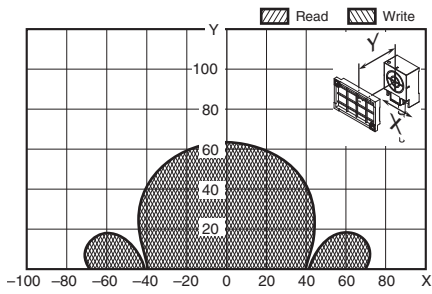

**V680-HS63 (with Metal on Back Surface) & V680S-DKF68 (Metal on back: Steel) (Tag direction: Vertical)**

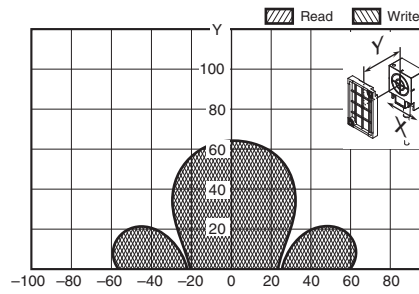

**V680-HS65 (with Metal on Back Surface) & V680S-DKF68 (Metal on back: Steel) (Tag direction: Horizontal)**

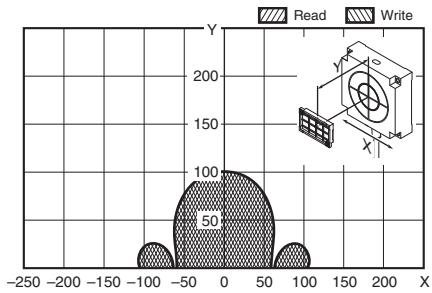

**V680-HS65 (with Metal on Back Surface) & V680S-DKF68 (Metal on back: Steel) (Tag direction: Vertical)**

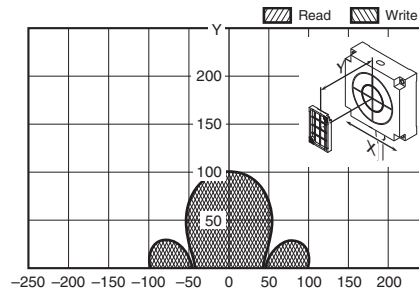

**V680-HS52 (embedded in non-metallic material) & V680-D2KF52M (embedded in non-metallic material)**

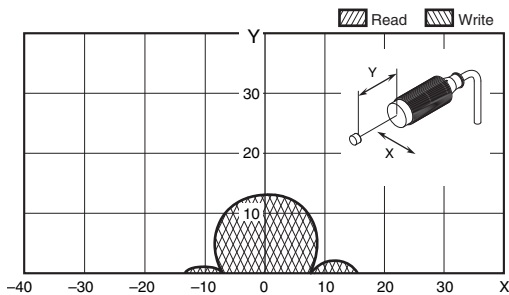

**V680-HS52 (embedded in non-metallic material) & V680-D2KF52M (embedded in metallic surface: steel)**

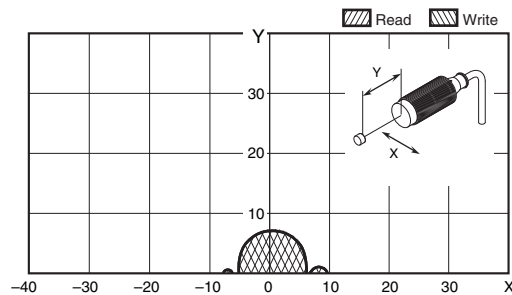

**V680-HS51 (embedded in metallic material) & V680-D2KF52M (embedded in non-metallic material)**

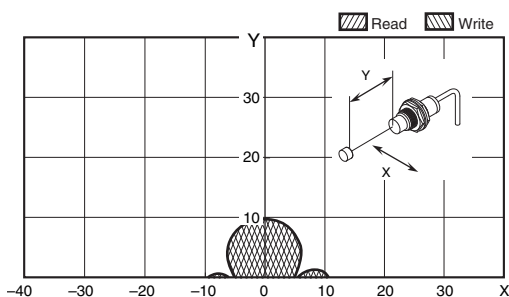

**V680-HS51 (embedded in metallic material) & V680-D2KF52M (embedded in metallic surface: steel)**

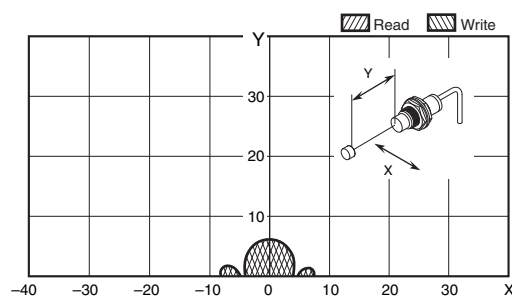

# V680 Series

**V680-HS63 (mounted on non-metallic material) & V680-D2KF52M (embedded in non-metallic material)**

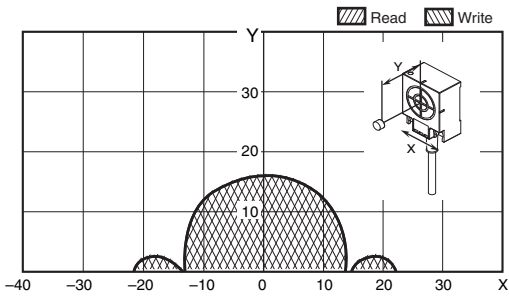

**V680-HS52 (embedded in Non-Metal) & V680S-D2KF67 (mounted on non-metallic material)**

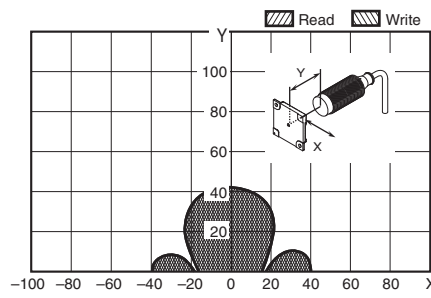

**2-kbyte Memory Bolt RF Tags**

**V680-HS51 (embedded in metallic material) & V680-D2KF52M-BT01 (mounted in metal/non-metallic material)**

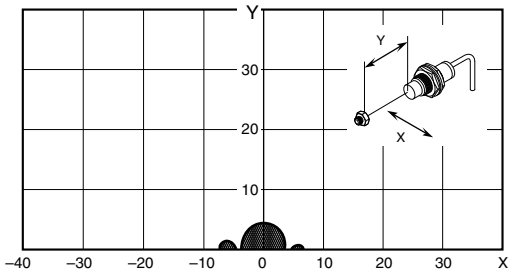

**V680-HS51 (embedded in metallic material) & V680-D2KF52M-BT11 (mounted in metal/non-metallic material)**

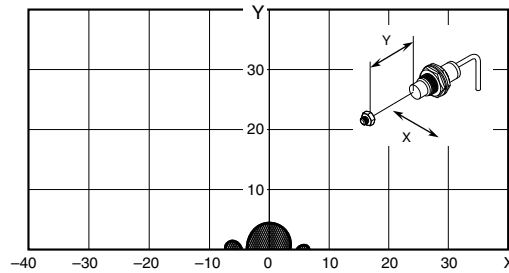

**V680-HS52 (embedded in non-metallic material) & V680-D2KF52M-BT01 (mounted in metal/non-metallic material)**

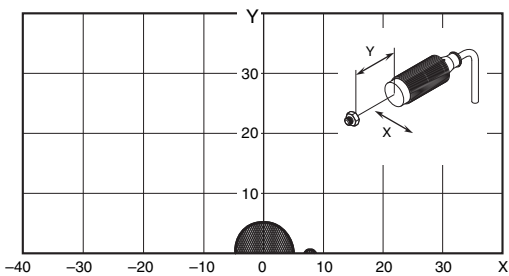

**8-kbyte Memory RF Tag**

The values given for communications ranges are reference values. Refer to pages 22 to 23 for communications distance specifications. The communications distance will depend on the RF Tags, ambient temperature, surrounding metal, noise, and other factors. Test operation completely when installing a system.

**V680-HS52 (embedded in non-metallic material) & V680S-D8KF67 V680-HS63 (mounted on non-metallic material) & V680S-D8KF67**

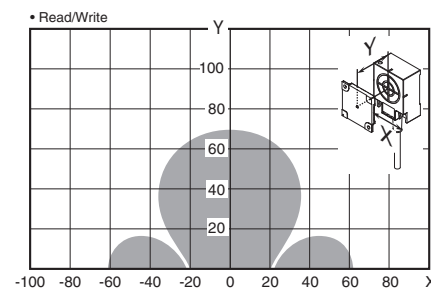
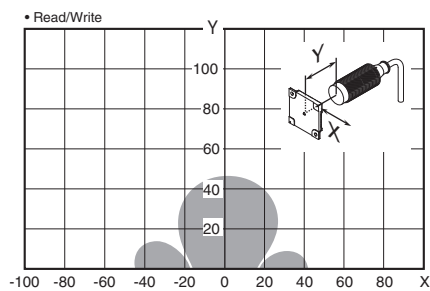

**V680-HS65 (mounted on metallic material) & V680S-D8KF67**

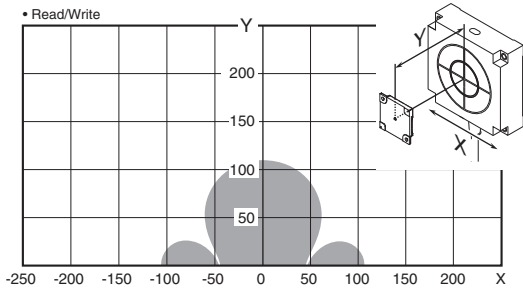

**V680-H01-V2 (mounted on non-metallic material) & V680S-D8KF67**

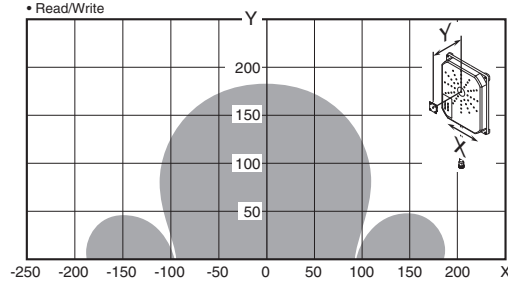

**V680-HS52 (embedded in non-metallic material) & V680S-D8KF67M (mounted on metallic surface: steel)**

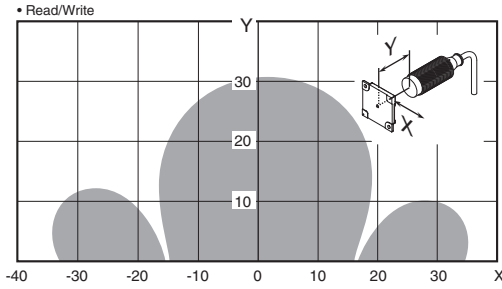

**V680-HS63 (mounted on non-metallic material) & V680S-D8KF67M (mounted on metallic surface: steel)**

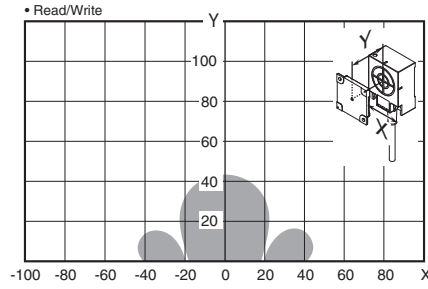

**V680-HS65 (mounted in metal) & V680S-D8KF67M (mounted on metallic surface: steel)**

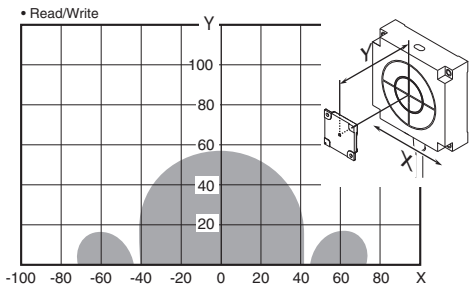

**V680-HS63 (mounted on non-metallic material) & V680S-D8KF68 (Tag direction: Horizontal)**

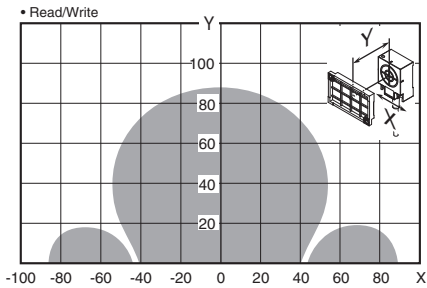

**V680-HS63 (mounted on non-metallic material) & V680S-D8KF68 (Tag direction: Vertical)**

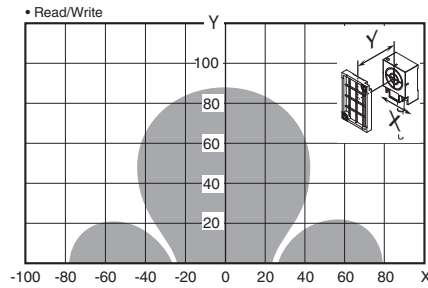

**V680-HS65 (mounted on metallic material) & V680S-D8KF68 (Tag direction: Horizontal)**

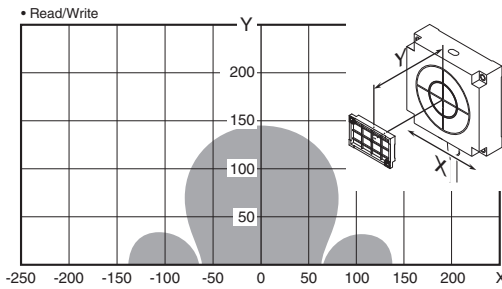

**V680-HS65 (mounted on metallic material) & V680S-D8KF68 (Tag direction: Vertical)**

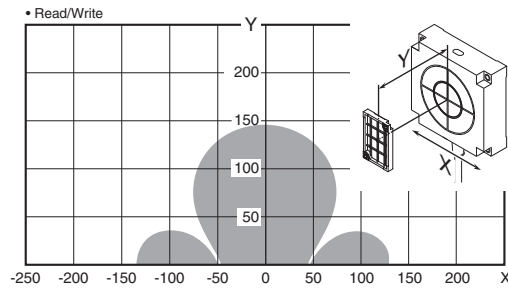

# V680 Series

**V680-H01-V2 (mounted on non-metallic material) & V680S-D8KF68 (Tag direction: Horizontal)**

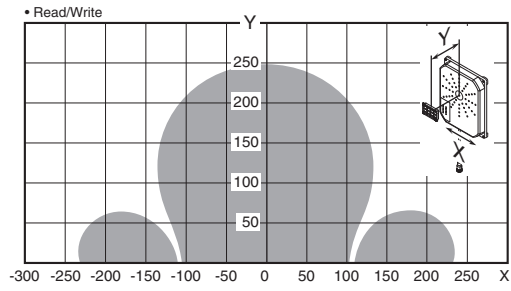

**V680-H01-V2 (mounted on non-metallic material) & V680S-D8KF68 (Tag direction: Vertical)**

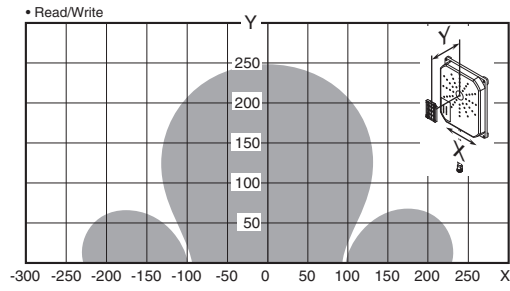

**V680-HS63 (mounted on non-metallic material) & V680S-D8KF68M (Metal on back: Steel (Tag direction: Horizontal))**

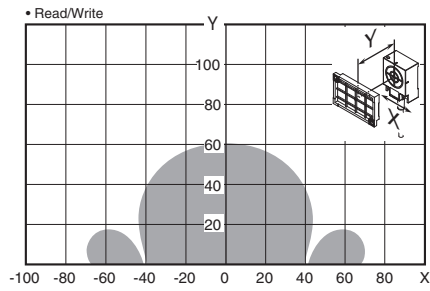

**V680-HS63 (mounted on non-metallic material) & V680S-D8KF68M (Metal on back: Steel (Tag direction: Vertical))**

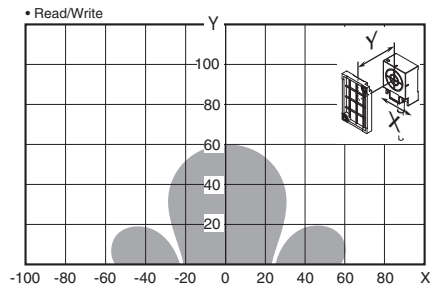

**V680-HS65 (mounted on metallic material) & V680S-D8KF68M (Metal on back: Steel (Tag direction: Horizontal))**

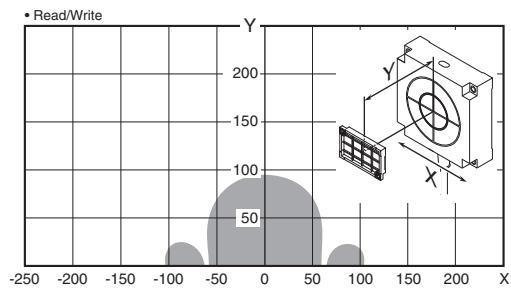

**V680-HS65 (mounted on metallic material) & V680S-D8KF68M (Metal on back: Steel (Tag direction: Vertical))**

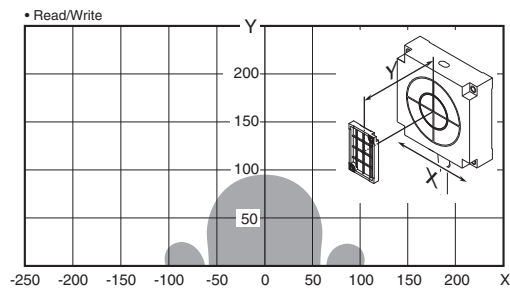

**DeviceNet ID Slave (When Using the V680-HAM42-DRT)  
PROFIBUS ID Slave (When Using the V680-HAM42-PRT)  
ID Flag Sensors (When Using the V680-HAM91/-HAM81)**

**1-kbyte Memory RF Tag**

The values given for communications ranges are reference values. Refer to pages 25 to 26, 30 for communications distance specifications. For information on the combinations that can be used, refer to Combinations of Amplifier Units, Antennas, and RF Tags on pages 2 to 3. The communications distance will depend on the RF Tags, ambient temperature, surrounding metal, noise, and other factors. Test operation completely when installing a system.

**V680-HS52 (embedded in non-metallic material) & V680-D1KP52MT (embedded in non-metallic material)**

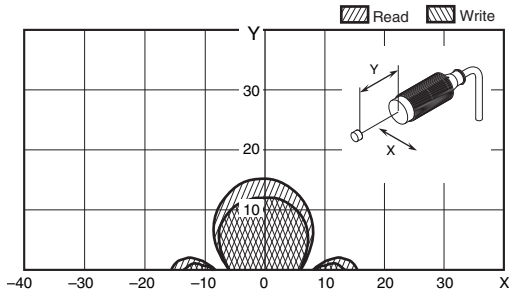

**V680-HS51 (embedded in metallic material) & V680-D1KP52MT (embedded in non-metallic material)**

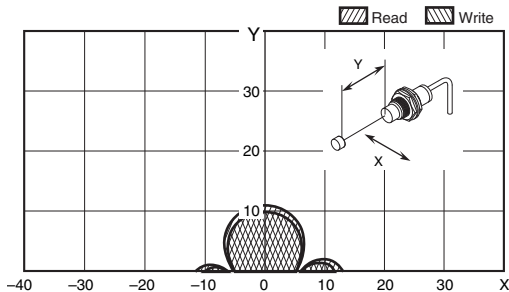

**V680-HS63 (mounted on non-metallic material) & V680-D1KP52MT (embedded in non-metallic material)**

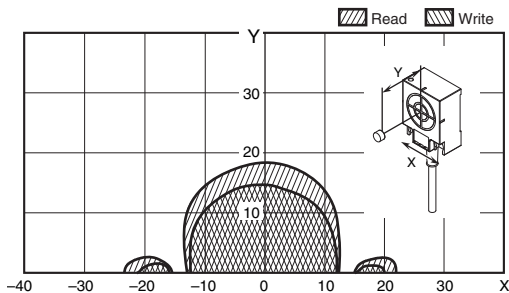

**V680-HS63 (mounted on non-metallic material) & V680-D1KP66T (mounted on non-metallic material)**

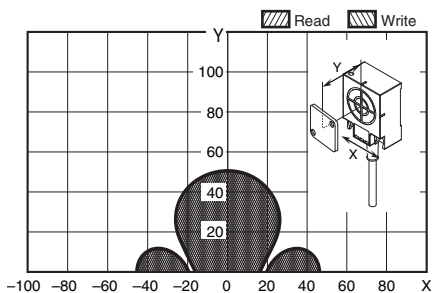

**V680-HS52 (embedded in non-metallic material) & V680-D1KP66T-SP (embedded in non-metallic material)**

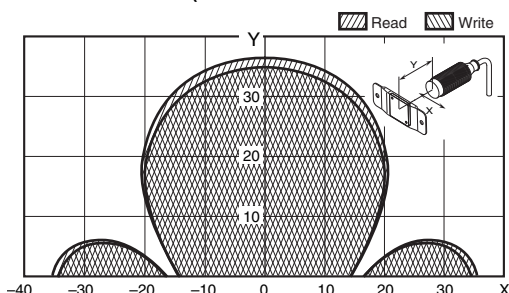

**V680-HS52 (embedded in non-metallic material) & V680-D1KP52MT (embedded in metallic surface: steel)**

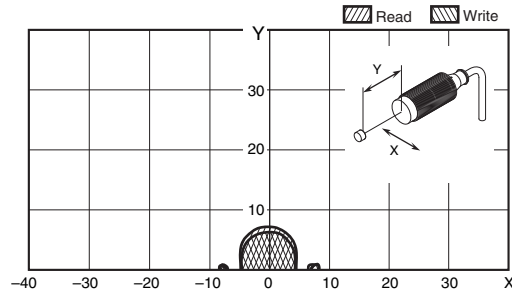

**V680-HS51 (embedded in metallic material) & V680-D1KP52MT (embedded in metallic surface: steel)**

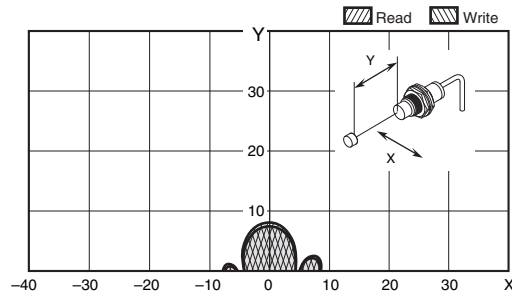

**V680-HS52 (embedded in non-metallic material) & V680-D1KP66T (mounted on non-metallic material)**

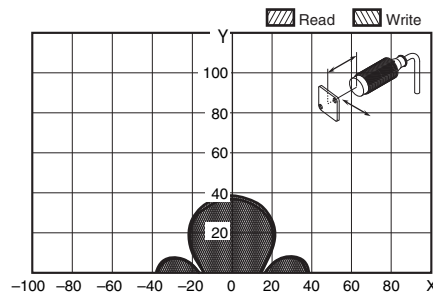

**V680-HS65 (mounted on metallic material) & V680-D1KP66T (mounted on non-metallic material)**

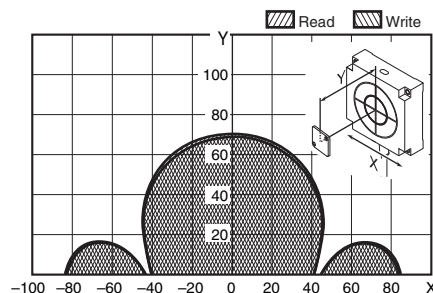

**V680-HS63 (mounted on non-metallic material) & V680-D1KP66T-SP (mounted on non-metallic material)**

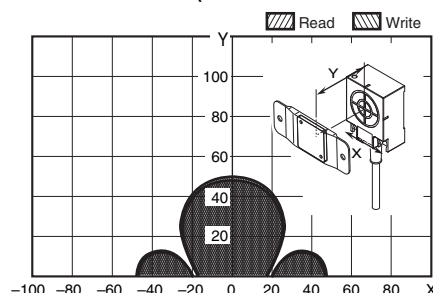

# V680 Series

**V680-HS65 (mounted on metallic material) & V680-D1KP66T-SP (mounted on non-metallic material)**

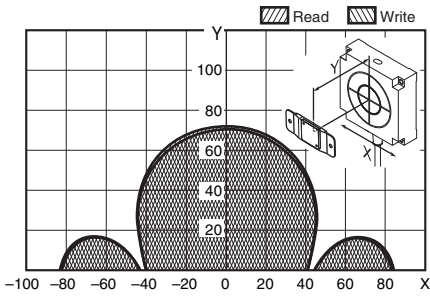

**V680-HS63 (mounted on non-metallic material) & V680-D1KP66MT (mounted on metallic surface: steel)**

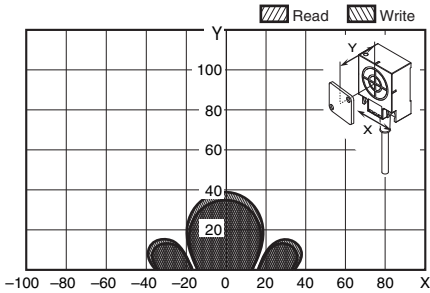

**V680-HS52 (embedded in non-metallic material) & V680-D1KP66MT (mounted on metallic surface: steel)**

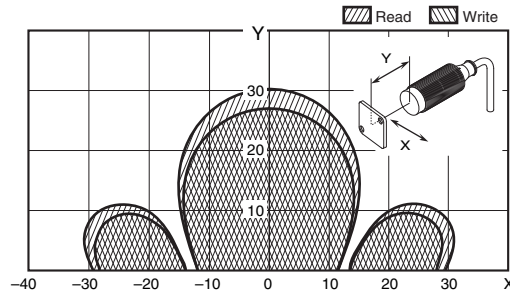

**V680-HS65 (mounted on metallic material) & V680-D1K66MT (mounted on metallic surface: steel)**

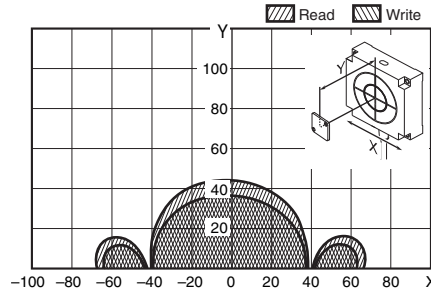

## 1-kbyte Memory Bolt RF Tags

**V680-HS51 (embedded in metallic material) & V680-D1KP52M-BT01 (mounted in metal/non-metallic material)**

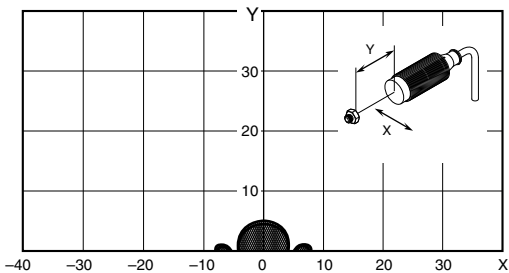

**V680-HS52 (embedded in non-metallic material) & V680-D1KP52M-BT01 (mounted in metal/non-metallic material)**

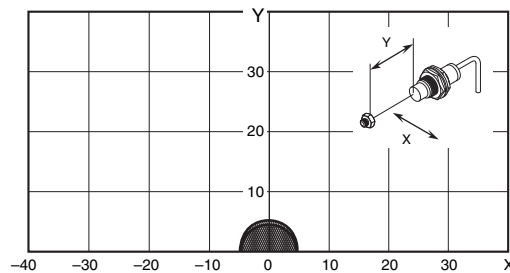

## 2-kbyte Memory RF Tag

The values given for communications ranges are reference values. Refer to pages 27 to 28, 30 for communications distance specifications. For information on the combinations that can be used, refer to Combinations of Amplifier Units, Antennas, and RF Tags on pages 2 to 3. The communications distance will depend on the RF Tags, ambient temperature, surrounding metal, noise, and other factors. Test operation completely when installing a system.

**V680-HS63 (mounted on non-metallic material) & V680S-D2KF67 (mounted on non-metallic material)**

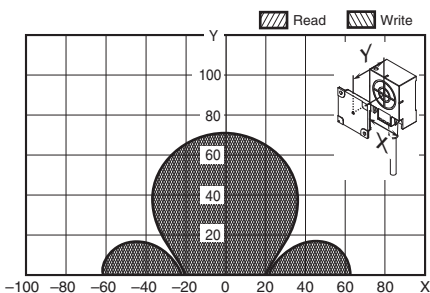

**V680-HS65 (mounted on metallic material) & V680S-D2KF67 (mounted on non-metallic material)**

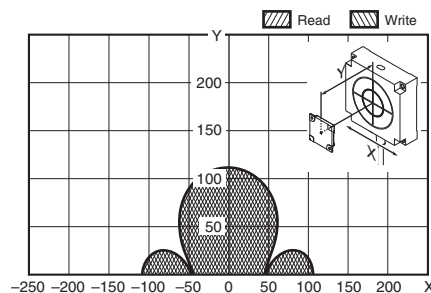

**V680-HS52 (embedded in non-metallic material) & V680S-D2KF67M (mounted on metallic surface: steel)**

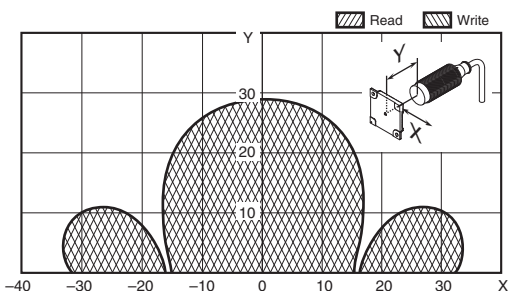

**V680-HS63 (mounted on non-metallic material) & V680S-D2KF67M (mounted on metallic surface: steel)**

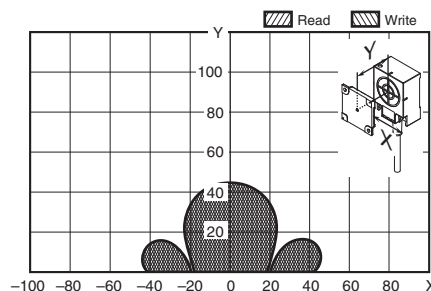



**V680-HS65 (mounted on metallic material) & V680S-D2KF67M (mounted on metallic surface: steel)**

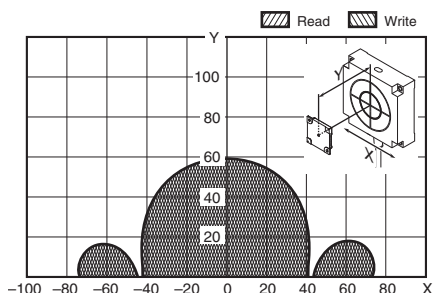

**V680-HS63 (with Metal on Back Surface) & V680S-D2KF68 (Tag direction: Horizontal)**

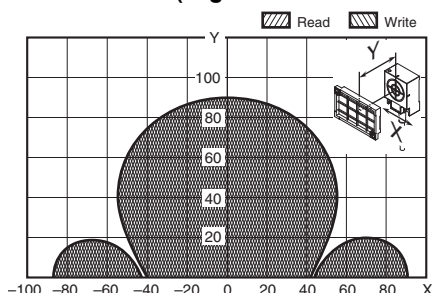

**V680-HS63 (with Metal on Back Surface) & V680S-D2KF68 (Tag direction: Vertical)**

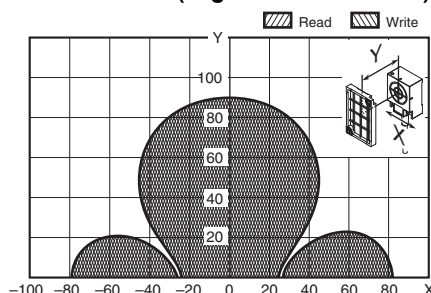

**V680-HS65 (with Metal on Back Surface) & V680S-D2KF68 (Tag direction: Horizontal)**

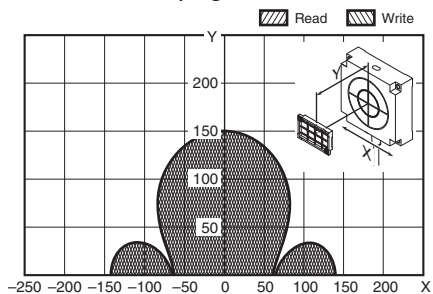

**V680-HS65 (with Metal on Back Surface) & V680S-D2KF68 (Tag direction: Vertical)**

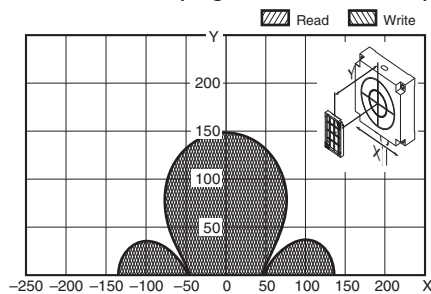

**V680-HS63 (with Metal on Back Surface) & V680S-D2KF68M (Metal on back: Steel) (Tag direction: Horizontal)**

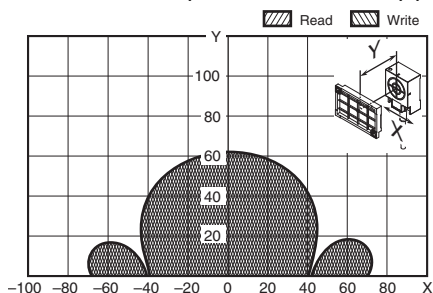

**V680-HS63 (with Metal on Back Surface) & V680S-D2KF68M (Metal on back: Steel) (Tag direction: Vertical)**

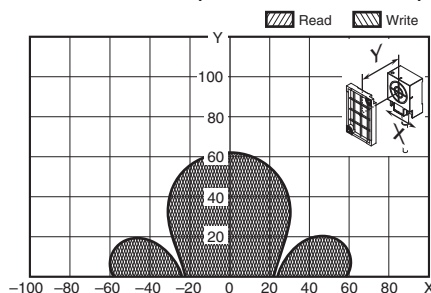

**V680-HS65 (with Metal on Back Surface) & V680S-D2KF68M (Metal on back: Steel) (Tag direction: Horizontal)**

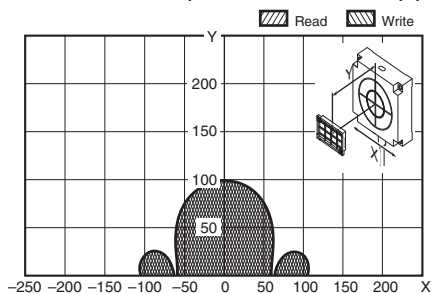

**V680-HS65 (with Metal on Back Surface) & V680S-D2KF68M (Metal on back: Steel) (Tag direction: Vertical)**

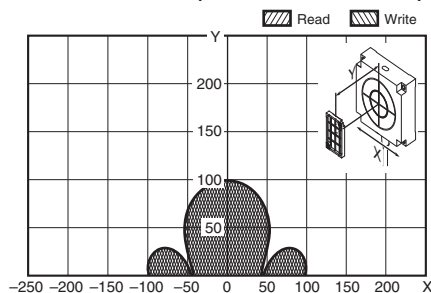

# V680 Series

**V680-HS52 (embedded in non-metallic material) & V680-D2KF52M (embedded in non-metallic material)**

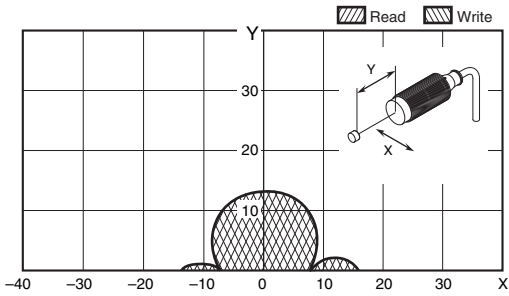

**V680-HS51 (embedded in metallic material) & V680-D2KF52M (embedded in non-metallic material)**

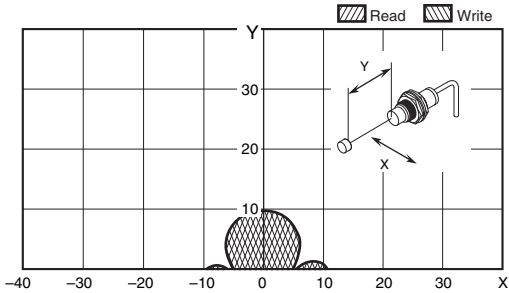

**V680-HS63 (mounted on non-metallic material) & V680-D2KF52M (embedded in non-metallic material)**

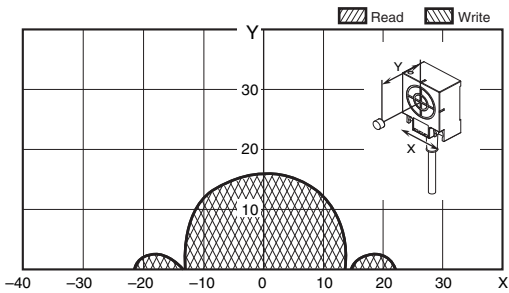

## 2-kbyte Memory Bolt RF Tags

**V680-HS51 (embedded in metallic material) & V680-D2KF52M-BT01 (mounted in metal/non-metallic material)**

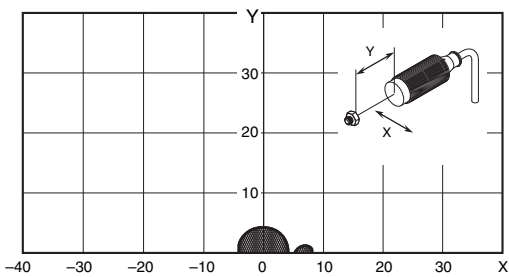

**V680-HS52 (embedded in non-metallic material) & V680-D2KF52M (embedded in metallic surface: steel)**

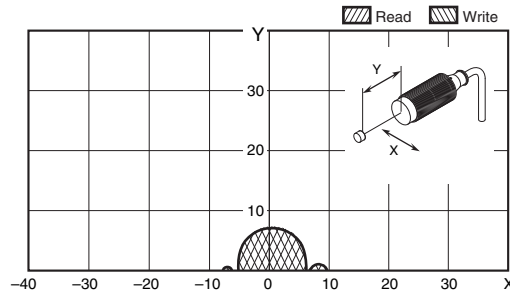

**V680-HS51 (embedded in metallic material) & V680-D2KF52M (embedded in metallic surface: steel)**

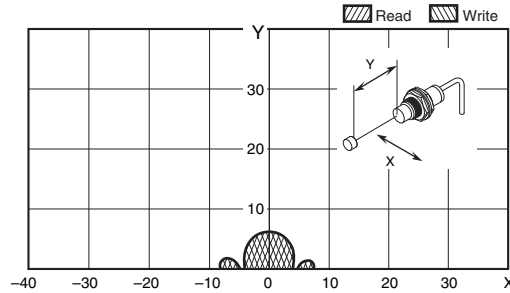

**V680-HS52 (embedded in non-metallic material) & V680S-D2KF67 (mounted on non-metallic material)**

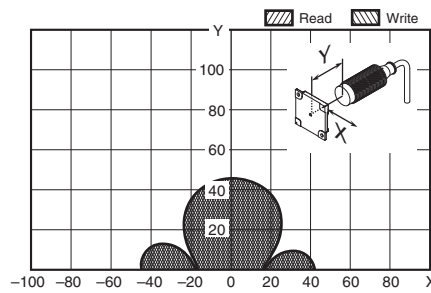

**V680-HS52 (embedded in non-metallic material) & V680-D2KF52M-BT01 (mounted in metal/non-metallic material)**

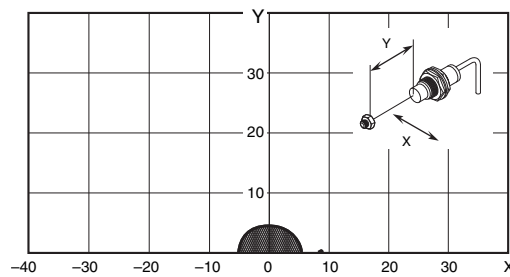

**8-kbyte Memory RF Tag**

The values given for communications ranges are reference values. Refer to pages 29 to 30 for communications distance specifications. For information on the combinations that can be used, refer to Combinations of Amplifier Units, Antennas, and RF Tags on pages 2 to 3. The communications distance will depend on the RF Tags, ambient temperature, surrounding metal, noise, and other factors. Test operation completely when installing a system.

**V680-HS52 (embedded on non-metallic material) & V680S-D8KF67**

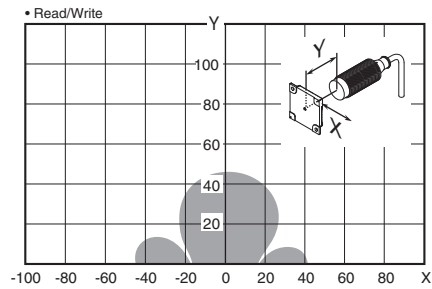

**V680-HS63 (mounted on non-metallic material) & V680S-D8KF67**

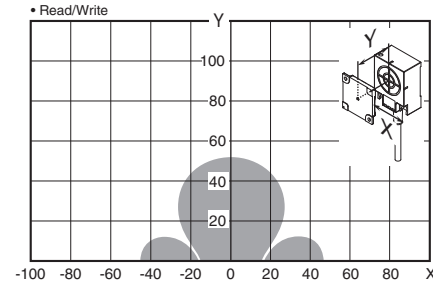

**V680-HS65 (mounted on metallic material) & V680S-D8KF67**

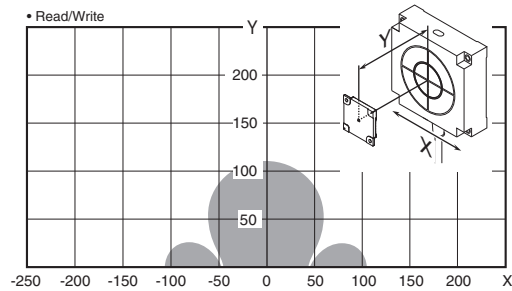

**V680-HS52 (embedded on non-metallic material) & V680S-D8KF67M (mounted on metallic surface: steel)**

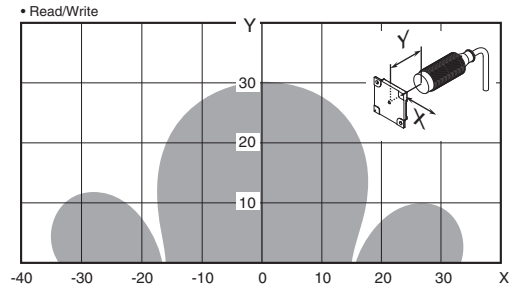

**V680-HS63 (mounted on non-metallic material) & V680S-D8KF67M (mounted on metallic surface: steel)**

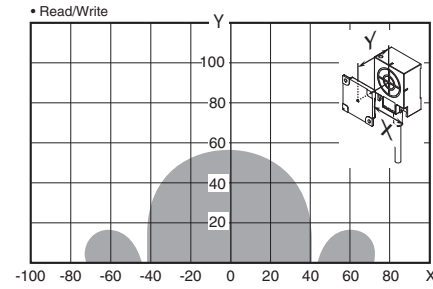

**V680-HS65 (mounted on metallic material) & V680S-D8KF67M (mounted on metallic surface: steel)**

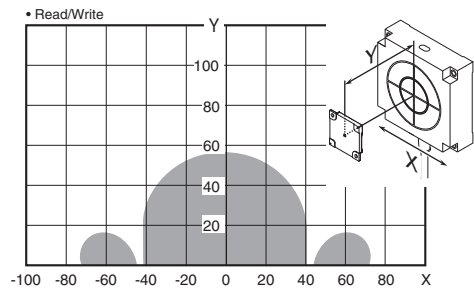

# V680 Series

**V680-HS63 (mounted on metallic surface: steel) & V680S-D8KF68 (Tag direction: Horizontal)**

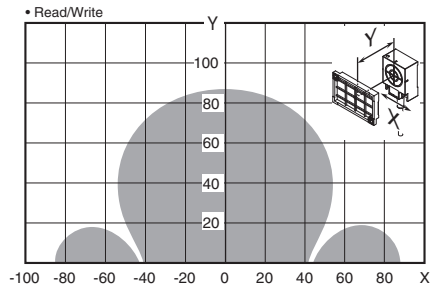

**V680-HS63 (mounted on metallic surface: steel) & V680S-D8KF68 (Tag direction: Vertical)**

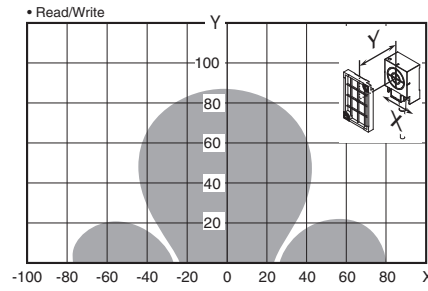

**V680-HS65 (mounted on metallic surface: steel) & V680S-D8KF68 (Tag direction: Horizontal)**

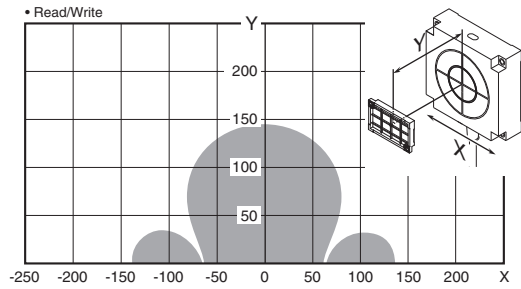

**V680-HS65 (mounted on metallic surface: steel) & V680S-D8KF68 (Tag direction: Vertical)**

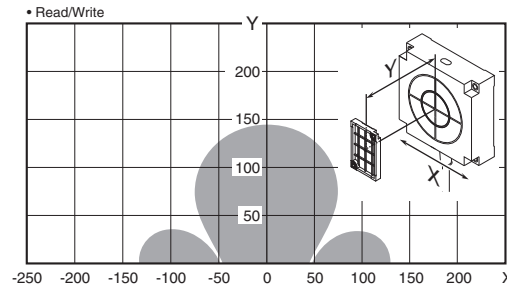

**V680-HS63 (mounted on metallic surface: steel) & V680S-D8KF68M (Tag direction: Horizontal)**

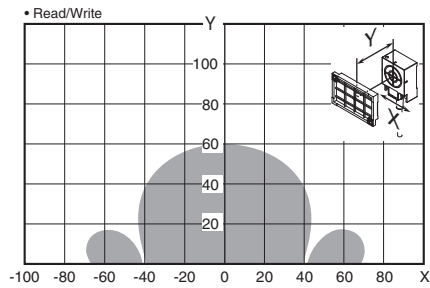

**V680-HS63 (mounted on metallic surface: steel) & V680S-D8KF68M (Tag direction: Vertical)**

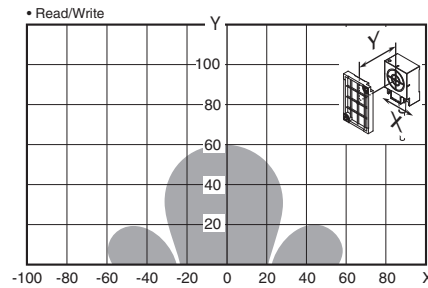

**V680-HS65 (mounted on metallic surface: steel) & V680S-D8KF68M (Tag direction: Horizontal)**

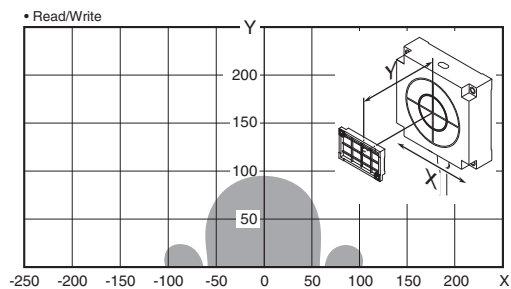

**V680-HS65 (mounted on metallic surface: steel) & V680S-D8KF68M (Tag direction: Vertical)**

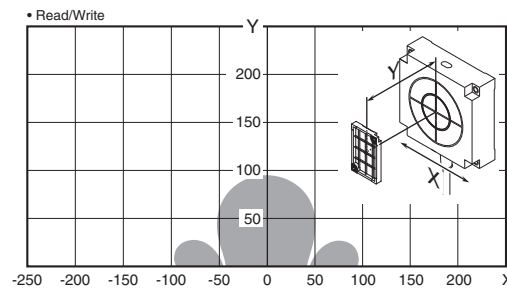

## Communications Time

### Communications Time between Antennas and Tags

#### ID Controllers (V680-CA5D0□-V2, NX-V680C1/C2, CJ1W-V680C11/C12, CS1W-V680C11/C12)

##### 1-kbyte Memory RF Tag

V680-D1KP□ (used in combination with the V680-HS□□ Antenna, V680-HA63A Amplifier Unit and V680-H01-V2 Antenna)

V680-D1KP58HTN (used in combination with the V680-H01-V2 Antenna)

##### ● Communications speed: Normal mode

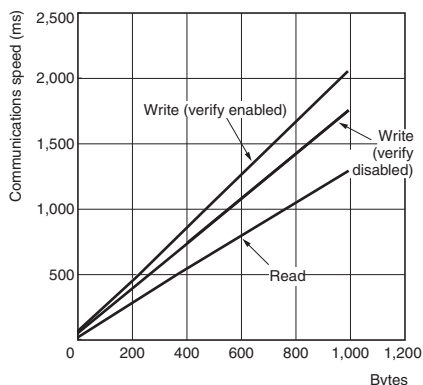

##### ● Communications speed: High-speed mode

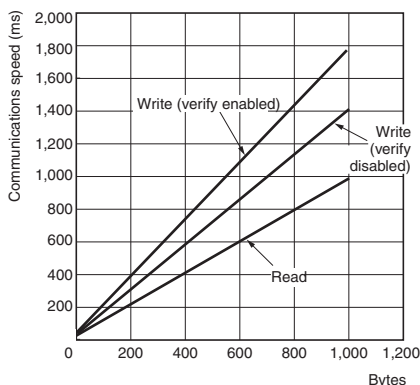

Communications speed setting	Command	Write verification setting	Communications time N: No. of bytes processed
Normal mode	Read	–	$T=1.3N+31$
	Write	Enabled	$T=2.1N+58$
Disabled		$T=1.8N+56$	
High-speed mode *1, *2	Read	–	$T=1.0N+29$
	Write	Enabled	$T=1.8N+51$
Disabled		$T=1.5N+47$	

\*1. The V680-H01 Antenna cannot be used in high-speed mode.

\*2. When using multi-access or FIFO communications options, normal-mode communications speed will be used regardless of the high-speed mode setting.

##### 2-kbyte Memory RF Tag

V680S-D2KF□□, V680S-D2KF52M/-D2KF52M-BT□□ (used in combination with the V680-HS□□ Antenna, V680-HA63B Amplifier Unit and V680-H01-V2 Antenna)

##### ● Communications speed: Normal mode

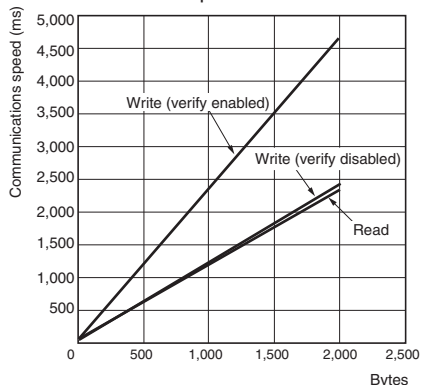

##### ● Communications speed: High-speed mode

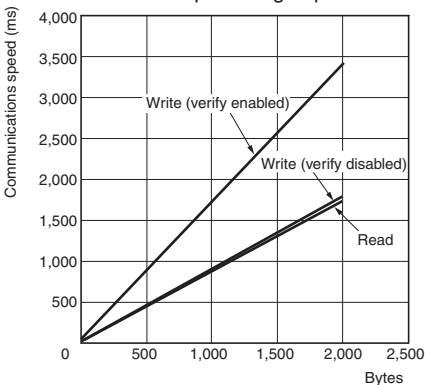

Communications speed setting	Command	Write verification setting	Communications time N: No. of bytes processed
Normal mode	Read	–	$T=1.2N+30$
	Write	Enabled	$T=2.4N+49$
Disabled		$T=1.2N+49$	
High-speed mode *	Read	–	$T=0.9N+27$
	Write	Enabled	$T=1.7N+49$
Disabled		$T=0.9N+41$	

\* When using multi-access or FIFO communications options, normal-mode communications speed will be used regardless of the high-speed mode setting.

##### 8-kbyte Memory RF Tag

V680S-D8KF□□

(used in combination with the V680-HS□□ Antenna and V680-HA63B Amplifier Unit)

##### ● Communications speed: Normal mode

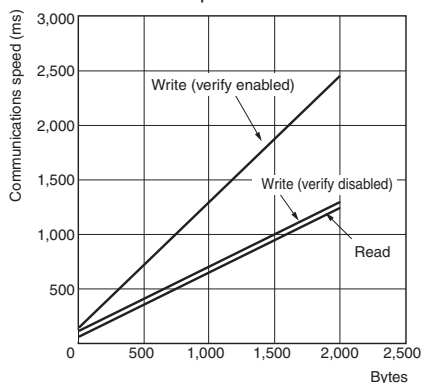

##### ● Communications speed: High-speed mode

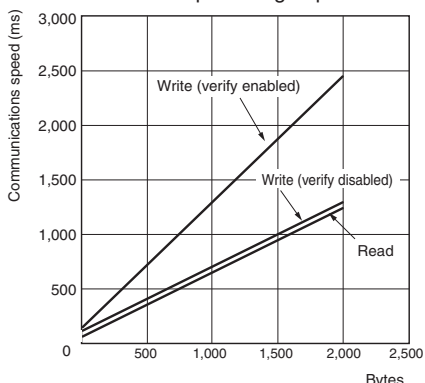

Communications speed setting	Command	Communications time N: No. of bytes processed
Normal mode	Read	$T=0.6N+47$
	Write (verify enabled)	$T=1.2N+128$
	Write (verify disabled)	$T=0.6N+101$
High-speed mode *	Read	$T=0.6N+47$
	Write (verify enabled)	$T=1.2N+128$
	Write (verify disabled)	$T=0.6N+101$

\* When using V680S-D8KF□□ RF Tag, normal-mode communications speed will be used regardless of the high-speed mode setting.

# V680 Series

## Communications Time (Communications Time between Antenna and RF Tag + Processing Time at Amplifier Unit)

### DeviceNet ID Slave (V680-HAM42-DRT) PROFIBUS ID Slave (V680-HAM42-PRT)

#### 1-kbyte Memory RF Tags

V680-D1KP□□ (V680-HS□□ Antenna)

Communications time setting	Command	Communications time (ms)			
		4-byte Access Mode	26-byte Access Mode	58-byte Access Mode	V600-compatible mode *
Normal	Read	67	95	137	67
	Write with Verification	105	143	210	105
	Data Fill	V680-HAM42-DRT: 17.5 × No. of processed blocks + 89.2 V680-HAM42-PRT: 20.6 × No. of processed blocks + 76.8			–
High speed	Read	63	85	117	–
	Write with Verification	89	128	186	–
	Data Fill	V680-HAM42-DRT: 14.8 × No. of processed blocks + 71.7 V680-HAM42-PRT: 18.8 × No. of processed blocks + 66.4			–

#### 2-kbyte Memory RF Tags

V680S-D2KF□, V680S-D2KF52M/-D2KF52M-BT□□ (V680-HS□□ Antenna)

Communications time setting	Command	Communications time (ms)			
		4-byte Access Mode	26-byte Access Mode	58-byte Access Mode	V600-compatible mode *
Normal	Read	65	92	130	65
	Write with Verification	105	142	219	105
	Data Fill	V680-HAM42-DRT: 17.5 × No. of processed blocks + 89.2 V680-HAM42-PRT: 21.2 × No. of processed blocks + 86.4			–
High speed	Read	61	81	110	–
	Write with Verification	86	124	178	–
	Data Fill	V680-HAM42-DRT: 14.8 × No. of processed blocks + 71.7 V680-HAM42-PRT: 17.2 × No. of processed blocks + 74.6			–

#### 8-kbyte Memory RF Tags

V680S-D8KF□□ (V680-HS□□ Antenna)

Communications time setting	Command	Communications time (ms)			
		4-byte Access Mode	26-byte Access Mode	58-byte Access Mode	V600-compatible mode *1
Normal	Read	42	42	60	42
	Write with Verification	133	133	170	133
	Data Fill	V680-HAM42-DRT: 9.1 × No. of processed blocks + 105.5 V680-HAM42-PRT: 9.1 × No. of processed blocks + 105.5			–
High speed #2	Read	42	42	60	42
	Write with Verification	133	133	170	133
	Data Fill	V680-HAM42-DRT: 9.1 × No. of processed blocks + 105.5 V680-HAM42-PRT: 9.1 × No. of processed blocks + 105.5			–

\*1. The V680-HAM42-PRT does not support V600-compatible mode.

\*2. When using V680S-D8KF□□ RF Tag, normal-mode communications speed will be used regardless of the high-speed mode setting.

### ID Flag Sensors (V680-HAM91/-HAM81)

Operating Mode	Communications time (ms)	
	Read	Write
RF Tag	Data Read, Verification read	Write, Bit Set, Bit Clear
1-kbyte/2-kbyte Memory RF Tag	43	87
8-kbyte Memory RF Tags	50	84

$$\text{RF Tag travel speed (conveyor speed)} = \frac{\text{Travel distance (D) in interrogation zone}}{\text{Communications time (T)}}$$

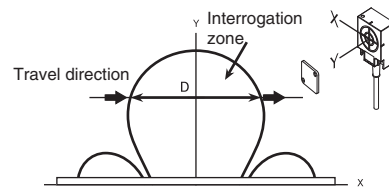

### Calculation Example

#### Read Processing Using Combination of V680-D1KP66T and V680-HS63

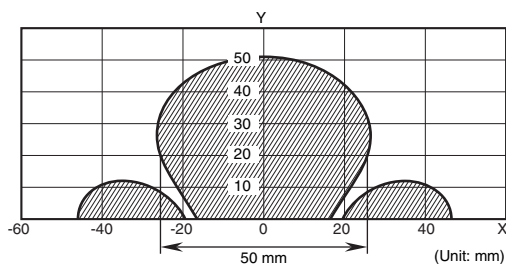

$$\text{RF Tag travel speed (m/min)} = \frac{50(\text{mm})}{43(\text{ms})} \doteq 69(\text{m/min})$$

- Note:**
1. The travel speed depends on factors such as the communications distance Y and axis offset. Therefore, it is recommended to refer to the interrogation zone figure and to perform operation using the widest part of the area.
  2. The calculated value is a rough guide. Perform testing with the actual devices before actual operation.
  3. This calculation formula does not include communications error processing.

## TAT When Using an ID Controller (Reference Values)

### TAT (Turn Around Time)

TAT refers to the total time required from the point at which a host device (such as a personal computer) starts sending a command until a response is received.

$$\text{TAT} = \text{Command send time} + \text{RF Tag communication time} + \text{response}$$

- Command send time: This is the time required for sending a command from the host device to the Controller. It varies depending on the communications speed and format.
- RF Tag communication time: This is the time required for communication between the Antenna and the RF Tag.
- Response receipt time: This is the time required for returning a response from the Controller to the host device. It varies depending on the communications speed and format.

- For an ordinary command

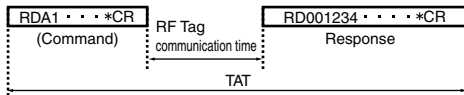

- Expansion Read Command

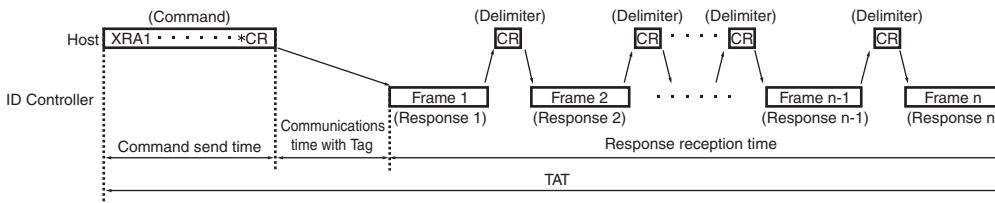

- Expansion Write Command

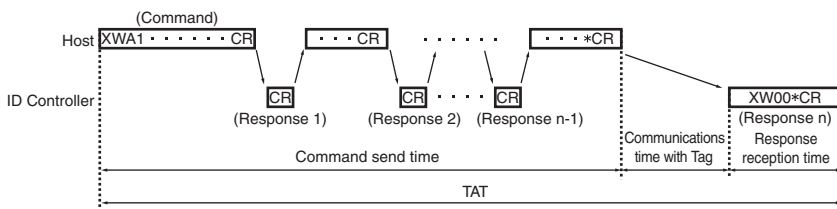



## Safety Precautions

### WARNING

**This product is not designed or rated for ensuring safety of persons.  
Do not use it for such purposes.**



\* This catalog is intended only to help select the appropriate product. Be sure to read the User's Manual for usage precautions prior to using the product.

### Precautions for Safe Use

To ensure safety, be sure to follow the following precautions:

1. Do not operate this product in any flammable, explosive, or corrosive gas environment.
2. Do not disassemble, repair, or remodel this product.
3. Tighten the base lock screws and terminal block screws completely.
4. Be sure to use wiring crimp terminals of the specified size.
5. If any cable has a locking mechanism, be sure to check that it has been locked before using it.
6. The DC power supply must be within the specified rating (24 VDC +10%/–15%).
7. Do not reverse the power supply connection.
8. Do not insert water, wire, etc., into any of the gaps in the case. Doing so may cause fire or electric shock.
9. Turn OFF the Controller or ID Sensor Unit power before attaching or removing the Antenna.
10. If multiple Antennas are mounted near each other, communications performance may decrease due to mutual interference. Refer to the manual for the Antennas and RF Tags and check to make sure there is no mutual interference before installation.
11. To remove the ID Controller, catch a tool on the mounting hook and gently remove the Unit.
12. Wire correctly and do not short-circuit the load. The ID Controller may rupture or burn.
13. Do not use in environments that are subject to oil.
14. Never use an AC power supply.
15. In the event that the product exhibits any abnormal condition, immediately stop using the system, turn OFF the power, and contact your OMRON sales representative.
16. Dispose of this product as industrial waste.
17. Be sure to follow any other warnings, cautions, and notices given in this document.

### Precautions for Correct Use

Please observe the following precautions to prevent failure to operate, malfunctions, or undesirable effects on product performance.

#### Installation Site

Install the product at a location where:

- It is not exposed to corrosive gases, dust, metal chips, or salt.
- The ambient operating temperature is within the range stipulated in the specifications.
- There are no sudden variations in temperature (no condensation).
- The ambient operating humidity is within the range stipulated in the specifications.
- No vibration or shock exceeding the values stipulated in the specifications is transmitted directly to the body of the product.
- It is not subject to splashing water, oil, or chemical substances.

#### Installation

- The product uses the 13.56-MHz frequency band to communicate with RF Tags. Some devices, such as some motors, inverters, and switching power supplies, generate electromagnetic waves (i.e., noise) that can affect communications with RF Tags. If any of these devices are nearby, communications with RF Tags may be affected or RF Tags may be destroyed. If the product is to be used near such devices, check the effects on communications before using the product.
- To minimize the general influence of noise, observe the following precautions:
  1. Ground any metallic material located around this device to 100Ω or less.
  2. Keep the product away from high voltage and heavy current.
- Do not pull on the cable.
- Do not use products that are not waterproof in misty environments.
- Do not subject the products to chemicals that adversely affect product materials.
- When installing the product, tighten screws to the following torque:
 

Controller:	1.2 N·m max
ID Sensor Unit:	0.4 N·m
V680-HS51 Antenna:	6 N·m
V680-HS52 Antenna:	40 N·m
V680-HS63 Antenna:	1.2 N·m
V680-HS65 Antenna:	1.2 N·m
V680-H01-V2 Antenna:	1.2 N·m

 (Attach the enclosed Mounting Brackets)
 

V680-D1KP66T/-D1KP66MT:	0.5 N·m
V680-D1KP66T-SP:	1.2 N·m
V680-D1KP54T:	0.3 to 0.5 N·m
V680S-D2KF67/-D2KF67M:	0.6 N·m
V680S-D2KF68/-D2KF68M:	1.2 N·m
V680S-D8KF67/-D8KF67M:	0.6 N·m
V680S-D8KF68/-D8KF68M:	1.2 N·m
- Do not pull the Antenna connector over the power of 30 N. The Antenna connector may be broken.
- Transmission will not be possible if the front and back panels are mistakenly reversed and the Unit is mounted to a metallic surface.
 

V680S-D2KF67M
V680S-D2KF68M
- The transmission distance will be reduced when the Unit is not mounted to a metallic surface.
 

V680S-D2KF67M
V680S-D2KF68M
V680S-D8KF67M
V680S-D8KF68M
- If multiple Antennas are mounted near each other, communications performance may decrease due to mutual interference. Refer to the User's Manual (Cat. No. Z248) and check to make sure there is no mutual interference.
- Depending on the operating environment, the case surface may become fogged, but basic performance will not be affected.
- When Antenna (only V680-H01-V2) is used in the United States and Canada, the ferrite core (ZCAT3035-1330) of the antenna's attachment is installed on controller's (V680-CA5D01-V□) DC power cable.
- The communications range is adversely affected if there is any metal material around the RF Tag.
- The maximum communications range can be obtained when the Antenna faces the RF tag directly. When the RF tag is installed at a tilt, the communications range is reduced. Consider the effect of the RF tag at tilt when installing the RF Tag.
- Provide the mounting distances between plural RF tags to prevent them from malfunctions due to mutual interference.
- If the central axis of an antenna and RF tag shifts, a communications range will fall.

# V680 Series

---

## Communications with Host (V680-HAM91/-HAM81)

The I/O status may be unstable when the ID Controller is started. After turning ON the power supply to the ID Controller, allow at least 1 second to elapse before performing control.

## Storage

Store the product at a location where:

- It is not exposed to corrosive gases, dust, metal chips, or salt.
- The ambient storage temperature is within the range stipulated in the specifications.
- There are no sudden variations in temperature (no condensation).
- The ambient storage humidity is within the range stipulated in the specifications.
- No vibration or shock exceeding the values stipulated in the specifications is transmitted directly to the body of the product.
- It is not subject to splashing water, oil, or chemical substances.

## Cleaning

Thinners, benzine, acetone, and kerosine may have adverse effects on resin parts and the case coating. Check the resistance to chemicals in the user's manual and do not use chemicals that may affect the product.

Dimensions

Tolerance class IT16 applies to dimensions in this datasheet unless otherwise specified.

RF Tag

V680-D1KP52MT/-D2KF52M

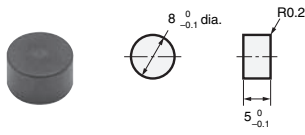

Case material	PPS resin
Filling	Epoxy resin

V680-D1KP53M

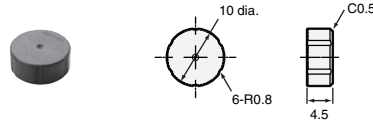

Case material	PPS resin
Filling	Epoxy resin

V680-D1KP54T

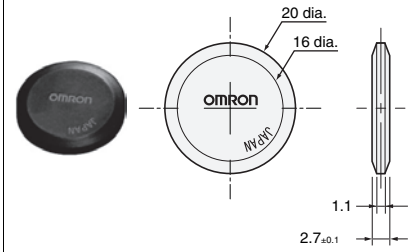

Case material	PPS resin
---------------	-----------

V680-D1KP66T/-D1KP66MT

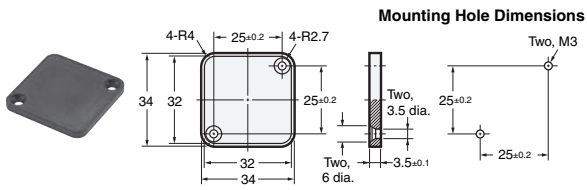

Case material	PPS resin
---------------	-----------

V680-D1KP66T-SP

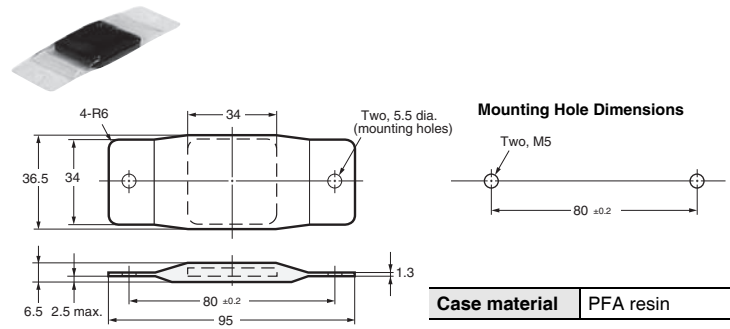

Case material	PFA resin
---------------	-----------

V680S-D2KF67/-D2KF67M  
V680S-D8KF67/-D8KF67M

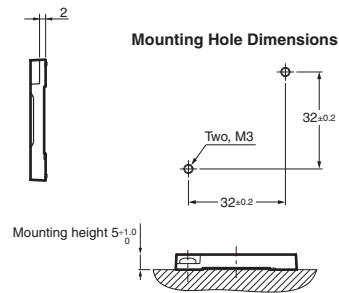
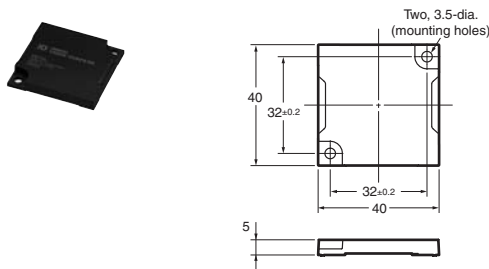

Case material	PPS resin
---------------	-----------

V680S-D2KF68/-D2KF68M  
V680S-D8KF68/-D8KF68M

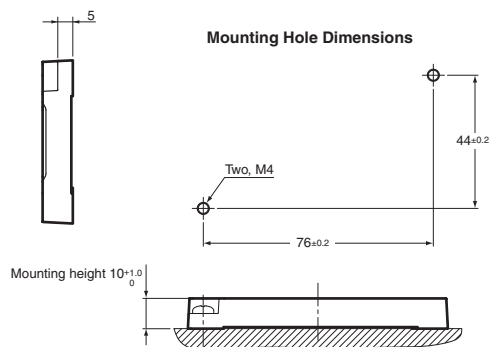
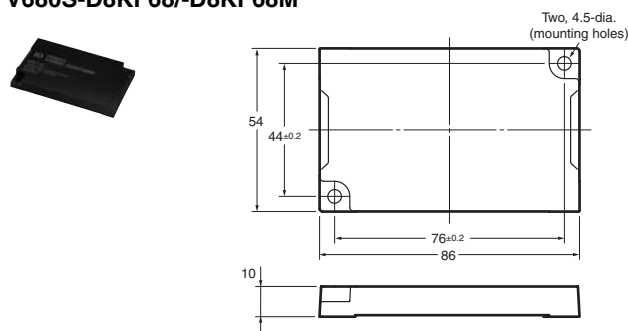

Case material	PPS resin
---------------	-----------

# V680 Series

## V680-D1KP58HTN

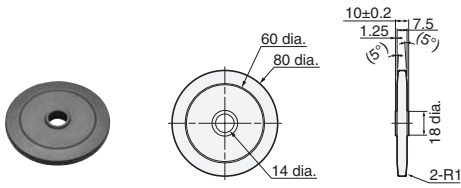

<b>Coating</b>	PPS resin
----------------	-----------

## V680-D1KP52M-BT01 V680-D2KF52M-BT01

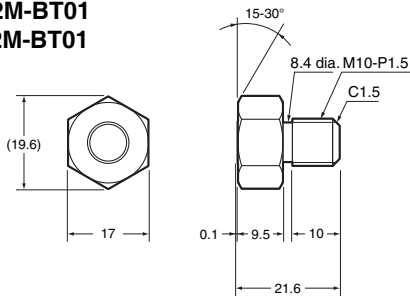

## V680-D1KP52M-BT11 V680-D2KF52M-BT11

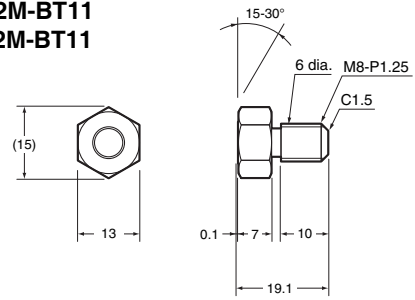

## Antenna with Detachable Amplifier Unit

### V680-HS52-W

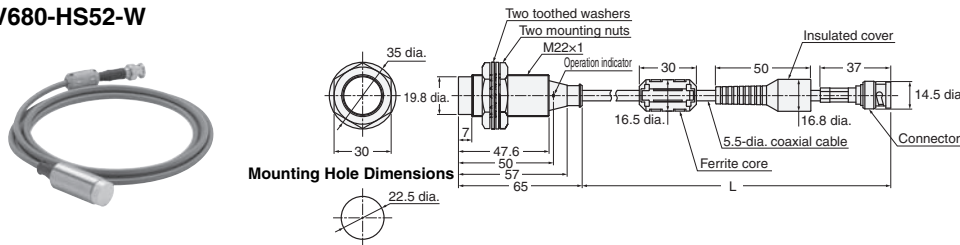

Cable length	L dimension
2 m	2,000 <sup>+100</sup> <sub>-50</sub>
12.5 m	12,500 <sup>+200</sup> <sub>-50</sub>
<b>Case material</b>	Brass
<b>Communication surface</b>	ABS resin
<b>Filling</b>	Epoxy resin
<b>Cable</b>	PVC

### V680-HS52-R

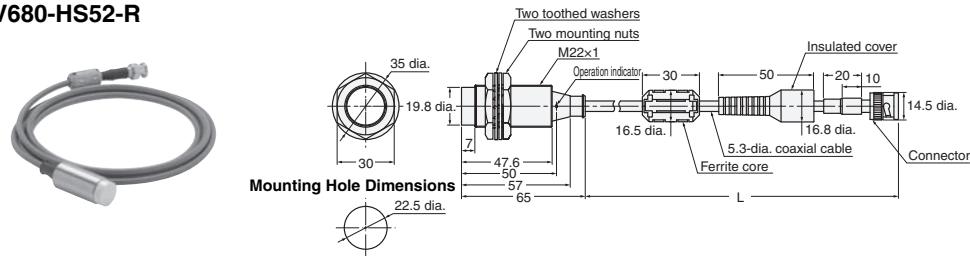

Cable length	L dimension
2 m	2,000 <sup>+100</sup> <sub>-50</sub>
12.5 m	12,500 <sup>+200</sup> <sub>-50</sub>
<b>Case material</b>	Brass
<b>Communication surface</b>	ABS resin
<b>Filling</b>	Epoxy resin
<b>Cable</b>	PVC

### V680-HS51

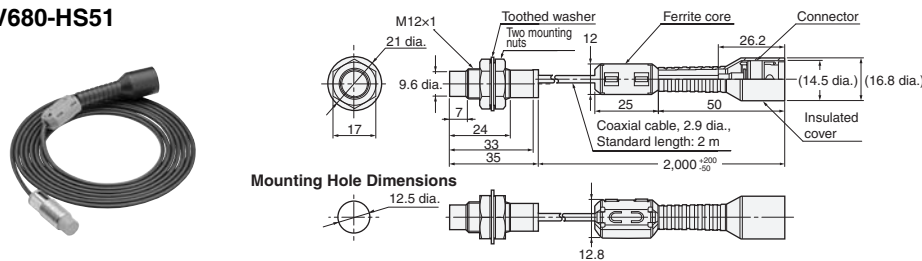

<b>Case material</b>	Brass
<b>Communication surface</b>	ABS resin
<b>Filling</b>	Epoxy resin
<b>Cable</b>	PVC

V680-HS63-W

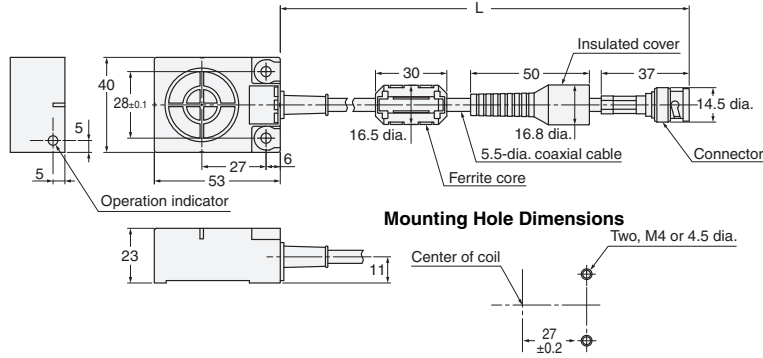

Cable length	L dimension
2 m	2,000 <sup>+100</sup> <sub>-50</sub>
12.5 m	12,500 <sup>+200</sup> <sub>-50</sub>
<b>Case material</b>	ABS resin
<b>Filling</b>	Epoxy resin
<b>Cable</b>	PVC

V680-HS63-R

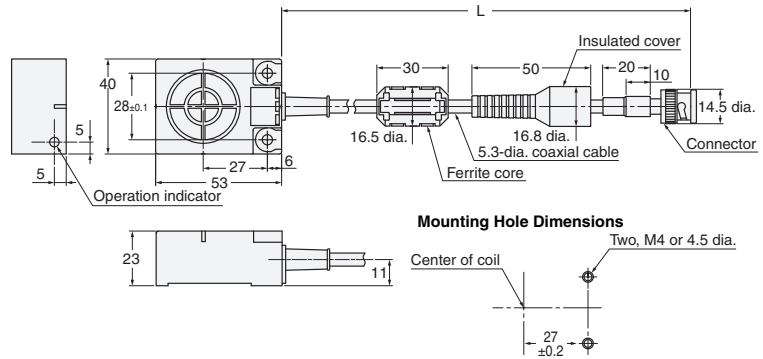

Cable length	L dimension
2 m	2,000 <sup>+100</sup> <sub>-50</sub>
12.5 m	12,500 <sup>+200</sup> <sub>-50</sub>
<b>Case material</b>	ABS resin
<b>Filling</b>	Epoxy resin
<b>Cable</b>	PVC

V680-HS65-W

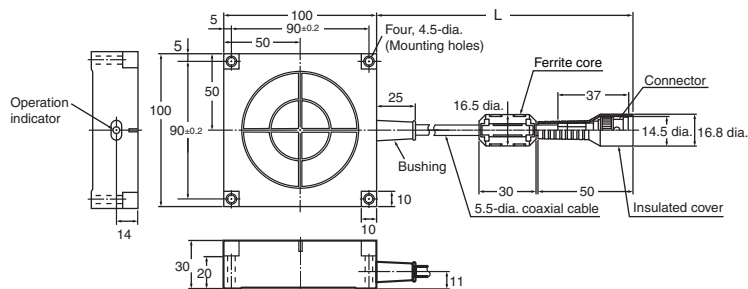

Cable length	L dimension
2 m	2,000 <sup>+100</sup> <sub>-50</sub>
12.5 m	12,500 <sup>+200</sup> <sub>-50</sub>
<b>Case material</b>	ABS resin
<b>Filling</b>	Epoxy resin
<b>Cable</b>	PVC (gray)

V680-HS65-R

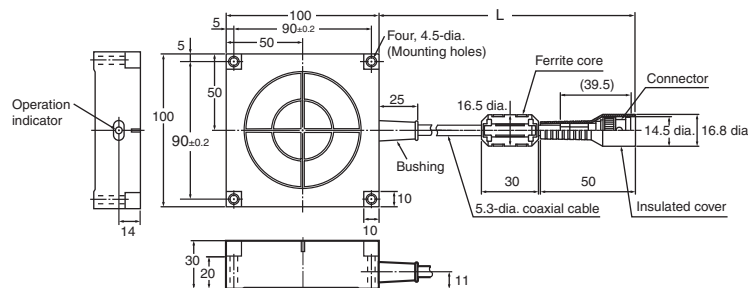

Cable length	L dimension
2 m	2,000 <sup>+100</sup> <sub>-50</sub>
12.5 m	12,500 <sup>+200</sup> <sub>-50</sub>
<b>Case material</b>	ABS resin
<b>Filling</b>	Epoxy resin
<b>Cable</b>	PVC (black)

# V680 Series

## Antenna with Built-in Amplifier Unit

### V680-H01-V2

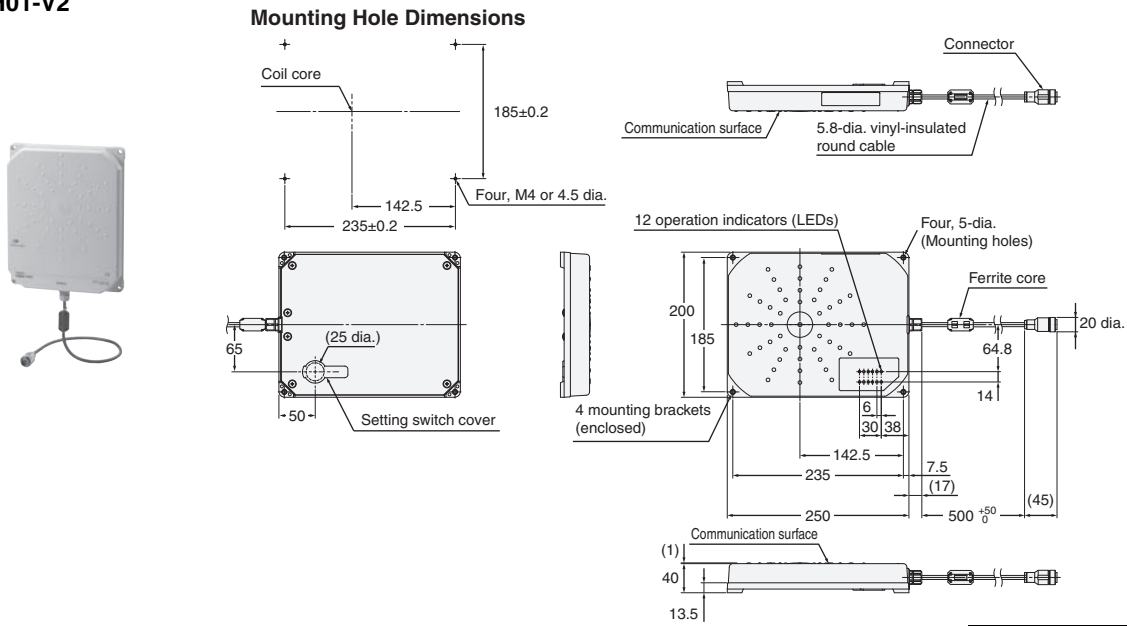

<b>Case material</b>	PC/ASA resin
<b>Filling</b>	Aluminum
<b>Cable</b>	PVC

## Amplifier Unit

### V680-HA63A/HA63B

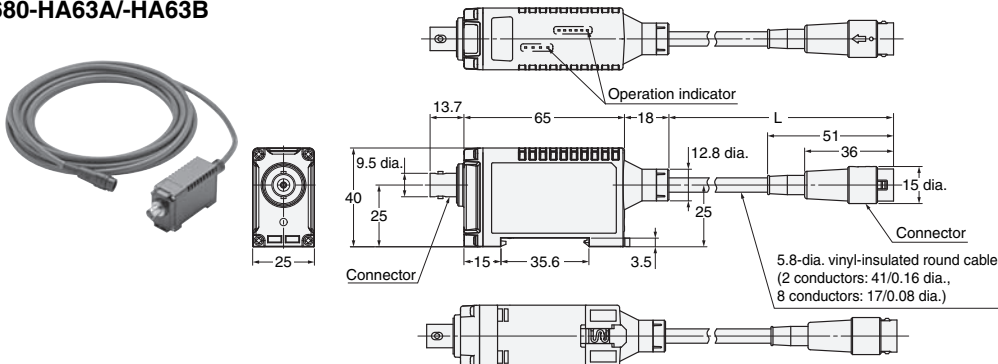

Cable length	L dimension
0.5 m	500 <sup>+100</sup> <sub>-50</sub>
5 m	5,000 <sup>+100</sup> <sub>-50</sub>
10 m	10,000 <sup>+200</sup> <sub>-100</sub>

<b>Case material</b>	PC resin
<b>Filling</b>	Epoxy resin
<b>Cable</b>	PVC

ID Controller

V680-CA5D01-V2/-CA5D02-V2



Mounting Hole Dimensions

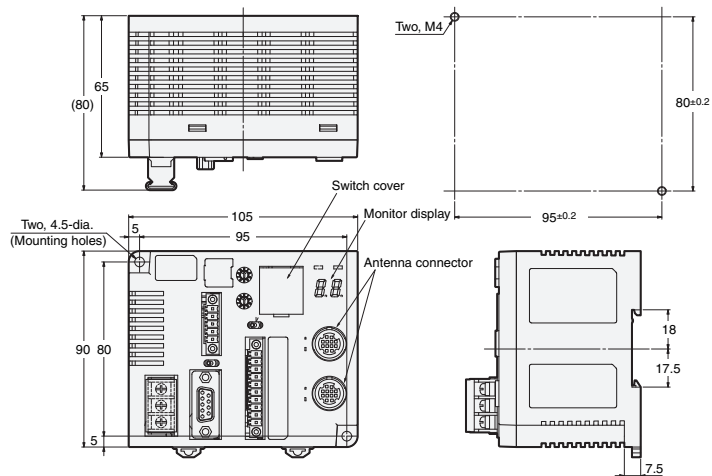

RFID Units

NX-V680C1 (One-channel)

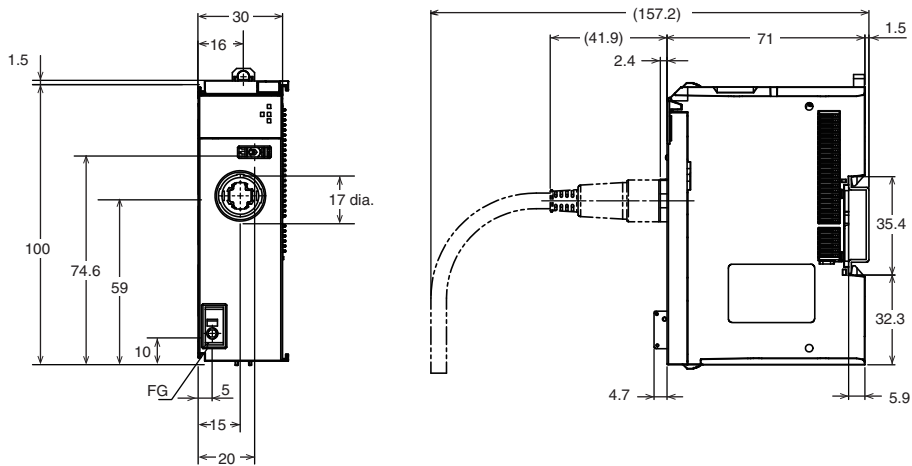

NX-V680C2 (Two-channels)

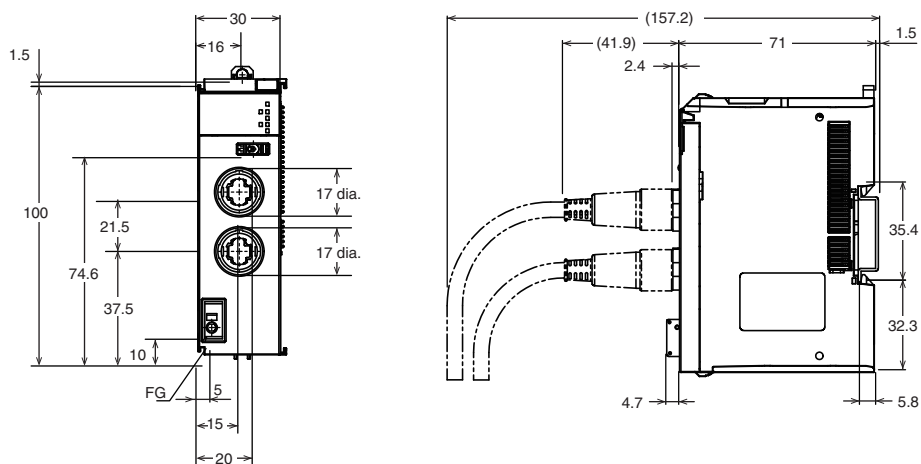

# V680 Series

## ID Sensor Units

### CJ1W-V680C11

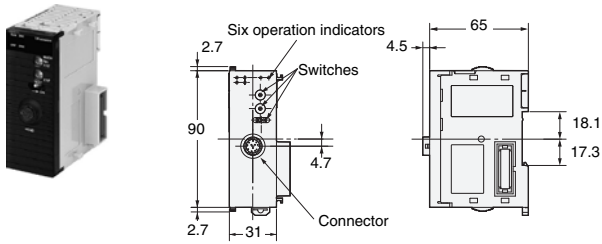

### CS1W-V680C11

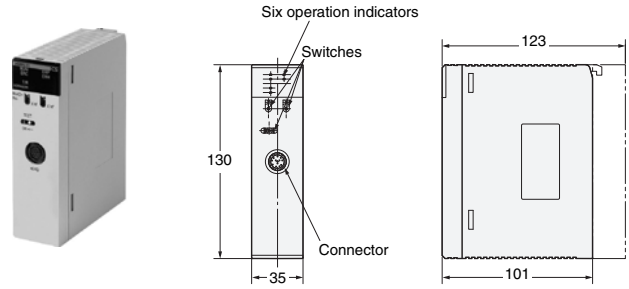

### CJ1W-V680C12

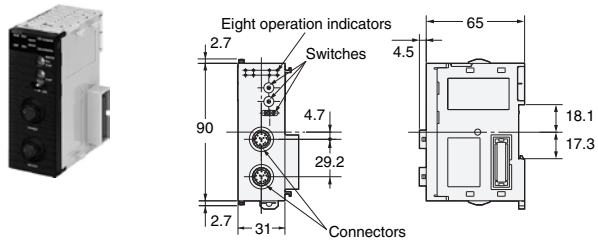

### CS1W-V680C12

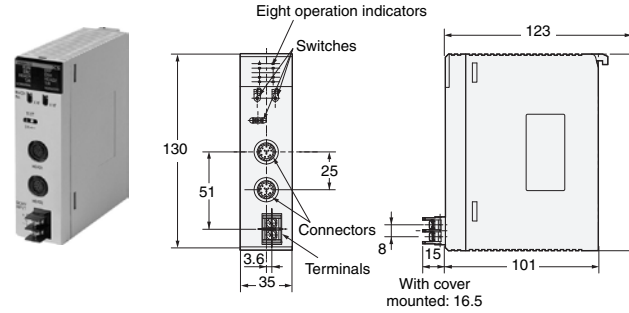

## Amplifier-integrated Controller (DeviceNet ID Slave/PROFIBUS ID Slave)

### V680-HAM42-DRT

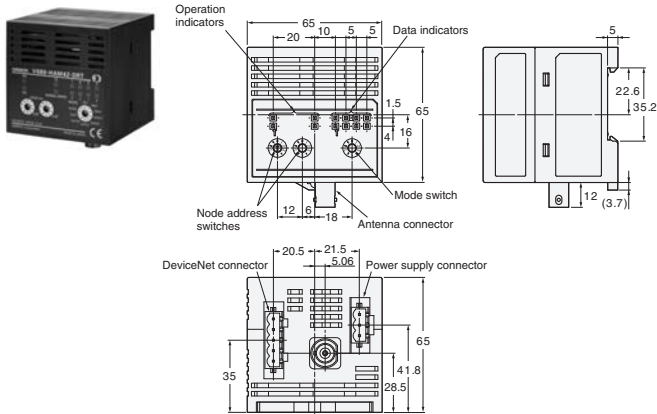

Case material PC+ABS resin

### V680-HAM42-PRT

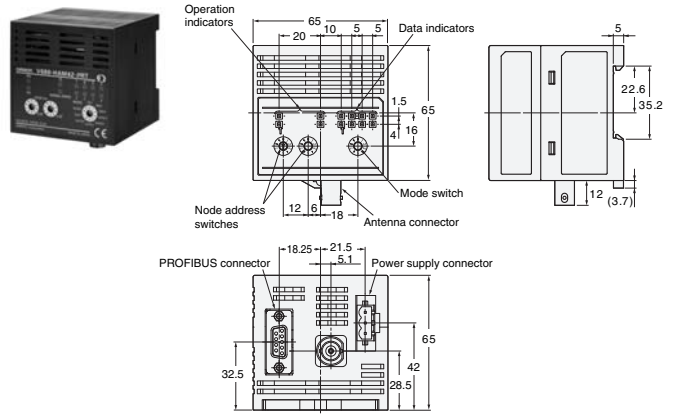

Case material PC+ABS resin



Amplifier-integrated Controllers (ID Flag Sensors)

V680-HAM91/-HAM81

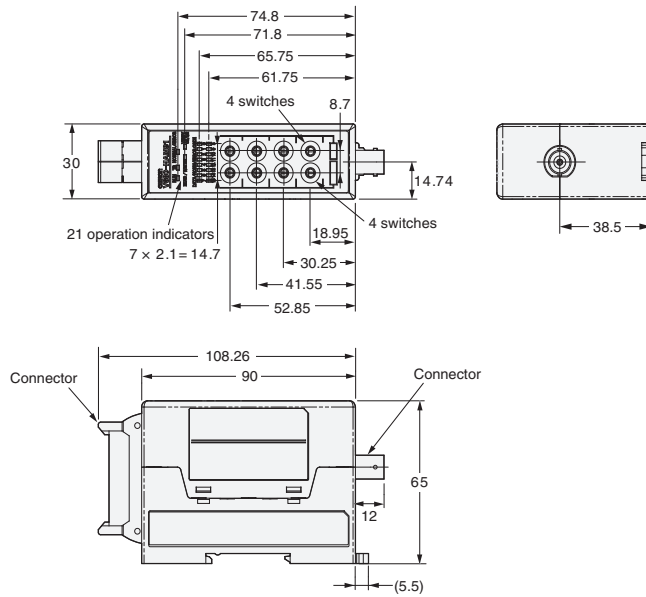

Case material	PC+ABS resin
---------------	--------------

Handheld Reader Writer

V680-CHUD

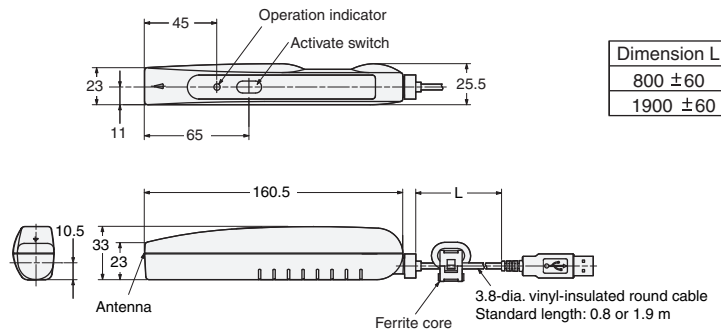

Case material	ABS resin
Cable	PVC

V680-CH1D

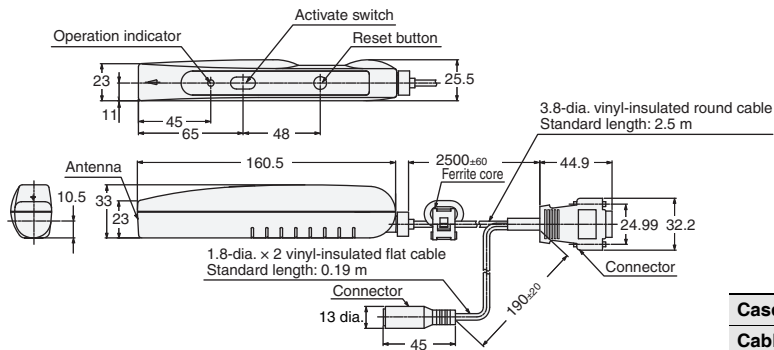

Case material	ABS resin
Cable	PVC

V680-CH1D-PSI

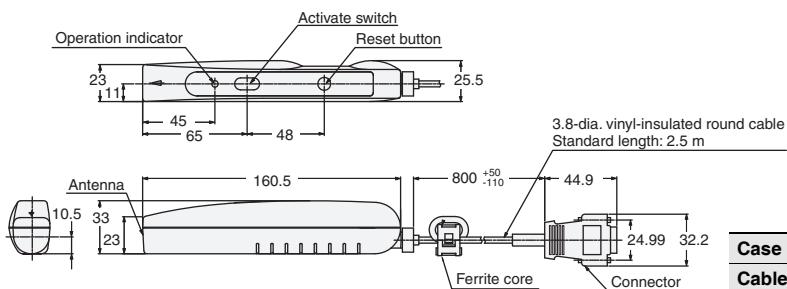

Case material	ABS resin
Cable	PVC

# V680 Series

## Interface Cables (Sold Separately)

### V680-A60 2M/5M/10M

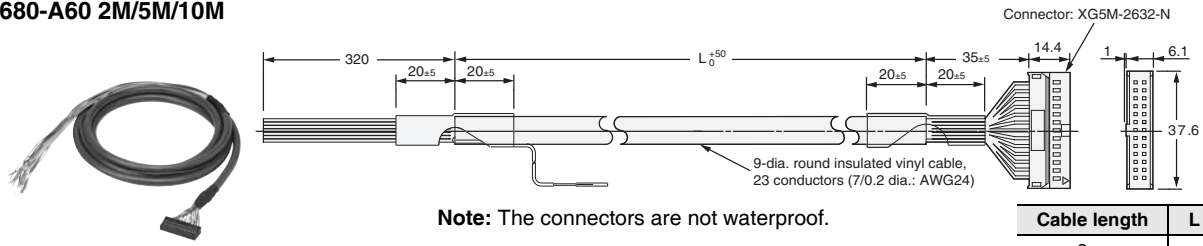

Cable length	L dimension
2 m	2,000
5 m	5,000
10 m	10,000

## AC Adapter

### V600-A22

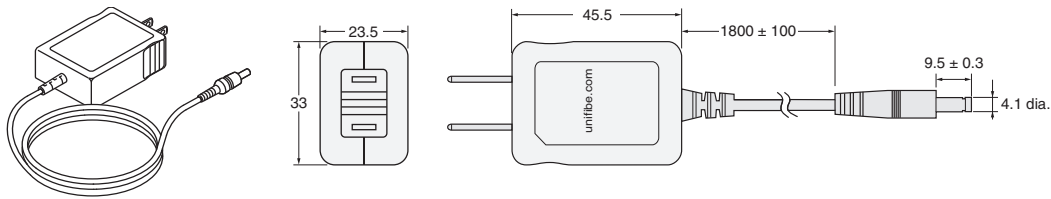

Accessories

V680-D1KP66T Attachments

V600-A86

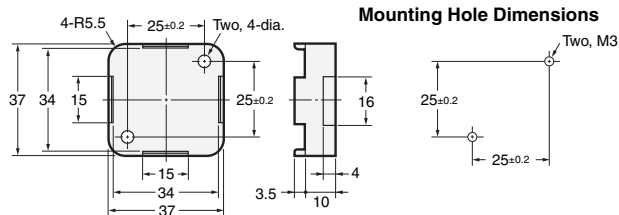

Case material	PPS resin
---------------	-----------

V680-D8KF68/-D32KF68 Attachments

V680-A81

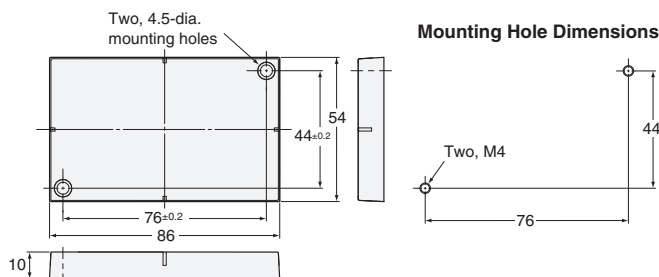

Case material	PBT resin
Filling	Epoxy resin

V680-D1KP58HTN Attachments

V680-A80

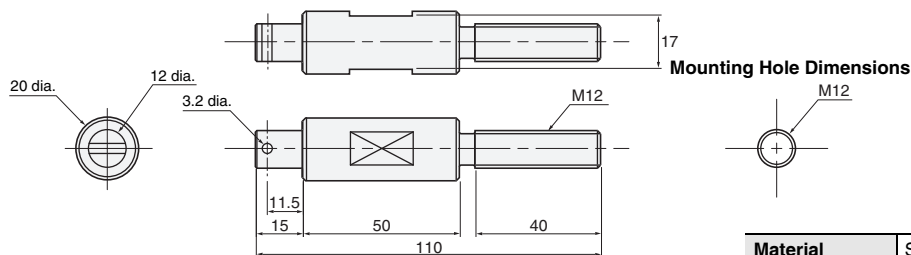

Material	Stainless steel
----------	-----------------

V680-D1KP54T Attachments

V700-A80

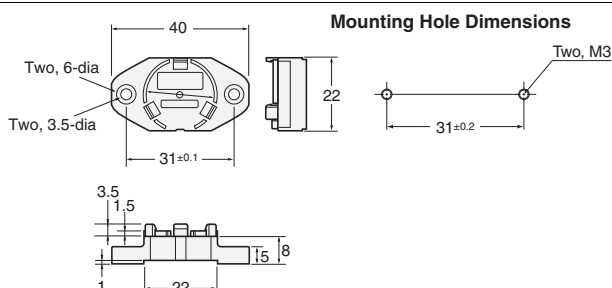

Material	PPS resin
----------	-----------

Amplifier Unit Special Extension Cable

- V700-A40 2M
- V700-A41 3M
- V700-A42 5M
- V700-A43 10M
- V700-A44 20M
- V700-A45 30M

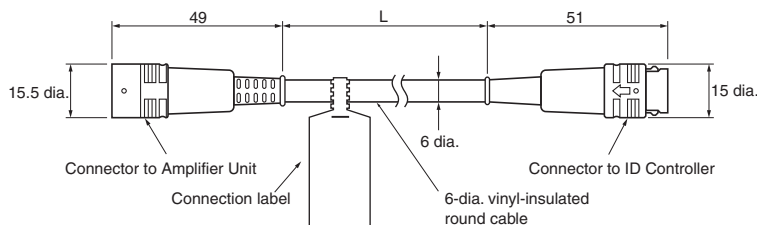

Cable length	L dimension
2 m	2,000±100
3 m	3,000±100
5 m	5,000±100
10 m	10,000±100
20 m	20,000±100
30 m	30,000±100
Material	PVC

V680-H01 Special Cables

- V700-A40-W 2M
- V700-A40-W 5M
- V700-A40-W 10M
- V700-A40-W 20M
- V700-A40-W 30M

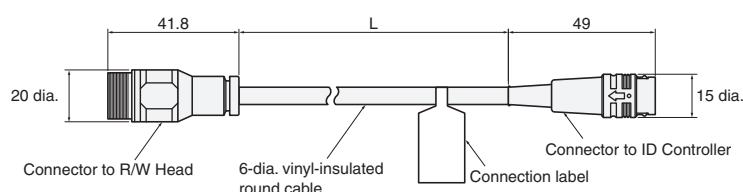

Cable length	L dimension
2 m	2,000±100
5 m	5,000±100
10 m	10,000±100
20 m	20,000±100
30 m	30,000±100
Material	PVC

## V680 Series

### Related Manuals

English Man.No.	Japanese Man.No.	Model	Name
Z248	SCHI-707	V680-HA63B/HS5□/HS6□/H01-V2/D2KF□□(M)(-BT□1), V680S-D2KF□□(M)/D8KF□□(M)	V680 series Amplifiers/Antennas/RF Tags (FRAM) User's Manual
Z262	SCHI-709	V680-HA63A/HS5□/HS□/H01-V2/D1KP□□M(T)(-BT□1)/D1KP□□T(-SP)/D1KP58HT	V680 series Amplifiers/Antennas/RF Tags (EEPROM) User's Manual
Z249	SCHI-708	V680-CA5D01-V2/CA5D02-V2	V680 series ID Controller User's Manual
Z401	SDGR-717	NX-V680C□	NX-series RFID Units User's Manual
W609	SBCA-473	SYSMAC-XR019	Sysmac Library User's Manual for RFID Communications Library
Z317	SDGR-703	CJ1W-V680C11/-V680C12	CJ series ID Sensor Units Operation Manual (NJ-series)
Z271	SCHI-711	CS1W-V680C11/-V680C12, CJ1W-V680C11/-V680C12	CJ/CS series ID Sensor Units User's Manual
Z278	SCHI-714	V680-HAM42-DRT	V680 series DeviceNet ID Slave User's Manual
Z320	SDGR-704	V680-HAM42-PRT/HS63-W/HS65-W/D1KP66(M)T/D1KP58HTN, V680S-D2KF□□(M)/D8KF□□(M)	V680 series PROFIBUS ID Slave User's Manual
Z268	SCHI-710	V680-HAM42-FRT	V680 series FL Remote ID User's Manual
Z279	SCHI-715	V680-HAM91/HAM81	V680 series ID Flag Sensors User's Manual
Z272	SCHI-712	V680-CHUD/CH1D/CH1D-PSI	V680 series Hand-held Reader Writer User's Manual
Z339	SDGR-709	V680S-HMD64-ETN/HMD66-ETN	V680S series User's Manual

- Sysmac is a trademark or registered trademark of OMRON Corporation in Japan and other countries for OMRON factory automation products.
- DeviceNet™ is a trademark of ODVA.
- Other company names and product names in this document are the trademarks or registered trademarks of their respective companies.

# Terms and Conditions Agreement

## Read and understand this catalog.

Please read and understand this catalog before purchasing the products. Please consult your OMRON representative if you have any questions or comments.

## Warranties.

- (a) Exclusive Warranty. Omron's exclusive warranty is that the Products will be free from defects in materials and workmanship for a period of twelve months from the date of sale by Omron (or such other period expressed in writing by Omron). Omron disclaims all other warranties, express or implied.
- (b) Limitations. OMRON MAKES NO WARRANTY OR REPRESENTATION, EXPRESS OR IMPLIED, ABOUT NON-INFRINGEMENT, MERCHANTABILITY OR FITNESS FOR A PARTICULAR PURPOSE OF THE PRODUCTS. BUYER ACKNOWLEDGES THAT IT ALONE HAS DETERMINED THAT THE PRODUCTS WILL SUITABLY MEET THE REQUIREMENTS OF THEIR INTENDED USE.

Omron further disclaims all warranties and responsibility of any type for claims or expenses based on infringement by the Products or otherwise of any intellectual property right. (c) Buyer Remedy. Omron's sole obligation hereunder shall be, at Omron's election, to (i) replace (in the form originally shipped with Buyer responsible for labor charges for removal or replacement thereof) the non-complying Product, (ii) repair the non-complying Product, or (iii) repay or credit Buyer an amount equal to the purchase price of the non-complying Product; provided that in no event shall Omron be responsible for warranty, repair, indemnity or any other claims or expenses regarding the Products unless Omron's analysis confirms that the Products were properly handled, stored, installed and maintained and not subject to contamination, abuse, misuse or inappropriate modification. Return of any Products by Buyer must be approved in writing by Omron before shipment. Omron Companies shall not be liable for the suitability or unsuitability or the results from the use of Products in combination with any electrical or electronic components, circuits, system assemblies or any other materials or substances or environments. Any advice, recommendations or information given orally or in writing, are not to be construed as an amendment or addition to the above warranty.

See <http://www.omron.com/global/> or contact your Omron representative for published information.

## Limitation on Liability; Etc.

OMRON COMPANIES SHALL NOT BE LIABLE FOR SPECIAL, INDIRECT, INCIDENTAL, OR CONSEQUENTIAL DAMAGES, LOSS OF PROFITS OR PRODUCTION OR COMMERCIAL LOSS IN ANY WAY CONNECTED WITH THE PRODUCTS, WHETHER SUCH CLAIM IS BASED IN CONTRACT, WARRANTY, NEGLIGENCE OR STRICT LIABILITY.

Further, in no event shall liability of Omron Companies exceed the individual price of the Product on which liability is asserted.

## Suitability of Use.

Omron Companies shall not be responsible for conformity with any standards, codes or regulations which apply to the combination of the Product in the Buyer's application or use of the Product. At Buyer's request, Omron will provide applicable third party certification documents identifying ratings and limitations of use which apply to the Product. This information by itself is not sufficient for a complete determination of the suitability of the Product in combination with the end product, machine, system, or other application or use. Buyer shall be solely responsible for determining appropriateness of the particular Product with respect to Buyer's application, product or system. Buyer shall take application responsibility in all cases.

NEVER USE THE PRODUCT FOR AN APPLICATION INVOLVING SERIOUS RISK TO LIFE OR PROPERTY OR IN LARGE QUANTITIES WITHOUT ENSURING THAT THE SYSTEM AS A WHOLE HAS BEEN DESIGNED TO ADDRESS THE RISKS, AND THAT THE OMRON PRODUCT(S) IS PROPERLY RATED AND INSTALLED FOR THE INTENDED USE WITHIN THE OVERALL EQUIPMENT OR SYSTEM.

## Programmable Products.

Omron Companies shall not be responsible for the user's programming of a programmable Product, or any consequence thereof.

## Performance Data.

Data presented in Omron Company websites, catalogs and other materials is provided as a guide for the user in determining suitability and does not constitute a warranty. It may represent the result of Omron's test conditions, and the user must correlate it to actual application requirements. Actual performance is subject to the Omron's Warranty and Limitations of Liability.

## Change in Specifications.

Product specifications and accessories may be changed at any time based on improvements and other reasons. It is our practice to change part numbers when published ratings or features are changed, or when significant construction changes are made. However, some specifications of the Product may be changed without any notice. When in doubt, special part numbers may be assigned to fix or establish key specifications for your application. Please consult with your Omron's representative at any time to confirm actual specifications of purchased Product.

## Errors and Omissions.

Information presented by Omron Companies has been checked and is believed to be accurate; however, no responsibility is assumed for clerical, typographical or proofreading errors or omissions.

**OMRON Corporation Industrial Automation Company**

Kyoto, JAPAN

Contact: [www.ia.omron.com](http://www.ia.omron.com)

**Regional Headquarters**

**OMRON EUROPE B.V.**

Wegalaan 67-69, 2132 JD Hoofddorp  
The Netherlands

Tel: (31)2356-81-300/Fax: (31)2356-81-388

**OMRON ELECTRONICS LLC**

2895 Greenspoint Parkway, Suite 200  
Hoffman Estates, IL 60169 U.S.A.

Tel: (1) 847-843-7900/Fax: (1) 847-843-7787

**OMRON ASIA PACIFIC PTE. LTD.**

No. 438A Alexandra Road # 05-05/08 (Lobby 2),  
Alexandra Technopark,  
Singapore 119967

Tel: (65) 6835-3011/Fax: (65) 6835-2711

**OMRON (CHINA) CO., LTD.**

Room 2211, Bank of China Tower,  
200 Yin Cheng Zhong Road,  
PuDong New Area, Shanghai, 200120, China

Tel: (86) 21-5037-2222/Fax: (86) 21-5037-2200

**Authorized Distributor:**

© OMRON Corporation 2018 All Rights Reserved.  
In the interest of product improvement,  
specifications are subject to change without notice.

**CSM\_1\_20\_1019**

**Cat. No. Q267-E1-01**

0918 (0918) (O)

## X-ON Electronics

Largest Supplier of Electrical and Electronic Components

*Click to view similar products for [RFID Transponder Tools](#) category:*

*Click to view products by [Omron](#) manufacturer:*

Other Similar products are found below :

[V700-A43 10M](#) [WF-SM-30](#) [V700-A44 20M](#) [V680-A81](#) [WS02-CFSC1-EV3](#) [V680-A60 5M](#) [V680-HAM91](#) [V700-A46 50M](#) [ST25-TAG-BAG-U](#) [MIKROE-3644](#) [ST25-TAG-BAG-E](#) [MIKROE-2395](#) [1482](#) [MIKROE-2462](#) [2800](#) [2802](#) [X-NUCLEO-NFC05A1](#) [359](#) [360](#) [361](#) [362](#) [363](#) [365](#) [3781](#) [789](#) [884](#) [4032](#) [4033](#) [4034](#) [4043](#) [4429](#) [4701](#) [AS3980-QF\\_DK\\_ST](#) [AS3953-DK-TAGS](#) [ATARFID-EK1](#) [ATARFID-EK2](#) [EVB90109](#) [MIKROE-3659](#) [MIKROE-3971](#) [MIKROE-4208](#) [MIKROE-1434](#) [MIKROE-1475](#) [MIKROE-1726](#) [MIKROE-262](#) [MIKROE-4309](#) [13429-6001](#) [LXRFZZHAAA-028-KIT](#) [OM25180FDKM](#) [MOD-RFID125](#) [3S4YR-HSR3](#)