

Miniature Basic Switch with Low Operating Force and High Contact Reliability

- Wide variation extends from micro load to 5A switching current, with shapes identical to those of the V-series Miniature Basic Switch.
- Unique internal mechanism ensures the high contact reliability even in micro load operations. Applicable for detection of lightweight objects.

RoHS Compliant

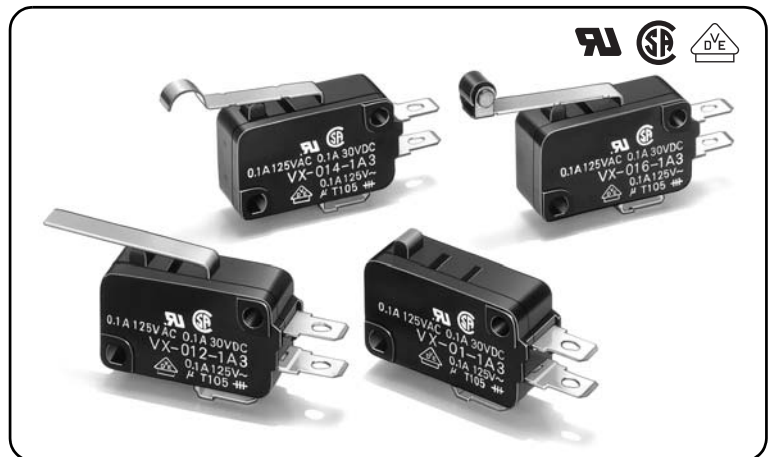





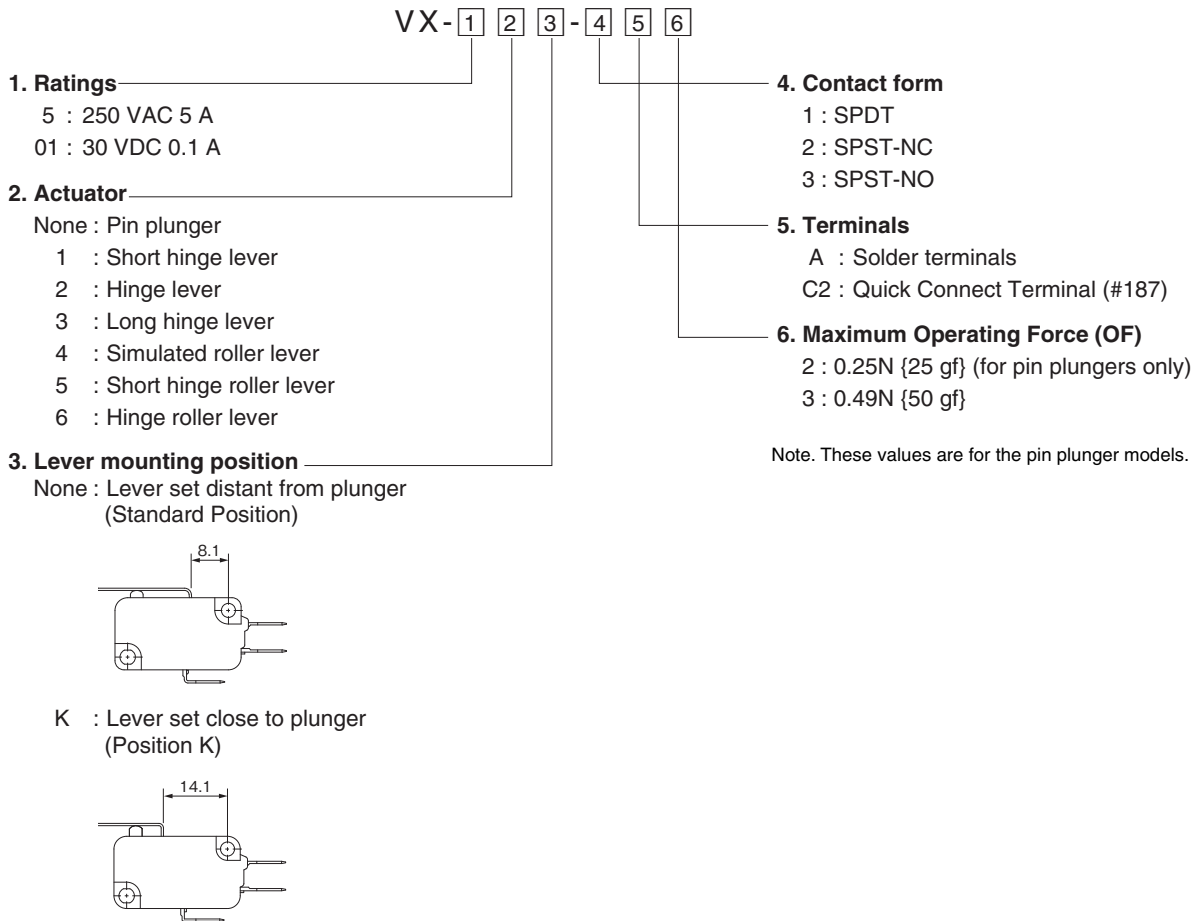

V
X

Model Number Legend



List of Models

| Actuator | Terminals | Contact Form | Ratings Lever mounting position Maximum Operating Force (OF) | 5 A | | 0.1 A | |
|---|-------------------------------|--------------|--|-------------------|-------------|-------------------|--------------|
| | | | | Standard Position | Position K | Standard Position | Position K |
| Pin plunger  | Solder terminals | SPDT | 0.25 N {25 gf} | VX-5-1A2 | - | VX-01-1A2 | - |
| | | SPST-NC | | VX-5-2A2 | - | VX-01-2A2 | - |
| | | SPST-NO | | VX-5-3A2 | - | VX-01-3A2 | - |
| | | SPDT | 0.49 N {50 gf} | VX-5-1A3 | - | VX-01-1A3 | - |
| | | SPST-NC | | VX-5-2A3 | - | VX-01-2A3 | - |
| | | SPST-NO | | VX-5-3A3 | - | VX-01-3A3 | - |
| | Quick Connect Terminal (#187) | SPDT | 0.25 N {25 gf} | VX-5-1C22 | - | VX-01-1C22 | - |
| | | SPST-NC | | VX-5-2C22 | - | VX-01-2C22 | - |
| | | SPST-NO | | VX-5-3C22 | - | VX-01-3C22 | - |
| | | SPDT | 0.49 N {50 gf} | VX-5-1C23 | - | VX-01-1C23 | - |
| | | SPST-NC | | VX-5-2C23 | - | VX-01-2C23 | - |
| | | SPST-NO | | VX-5-3C23 | - | VX-01-3C23 | - |
| Short hinge lever  | Solder terminals | SPDT | 0.49 N {50 gf} | VX-51-1A3 | - | VX-011-1A3 | - |
| | | SPST-NC | | VX-51-2A3 | - | VX-011-2A3 | - |
| | | SPST-NO | | VX-51-3A3 | - | VX-011-3A3 | - |
| | Quick Connect Terminal (#187) | SPDT | | VX-51-1C23 | - | VX-011-1C23 | - |
| | | SPST-NC | | VX-51-2C23 | - | VX-011-2C23 | - |
| | | SPST-NO | | VX-51-3C23 | - | VX-011-3C23 | - |
| Hinge lever  | Solder terminals | SPDT | 0.29 N {30 gf} | VX-52-1A3 | - | VX-012-1A3 | - |
| | | SPST-NC | | VX-52-2A3 | - | VX-012-2A3 | - |
| | | SPST-NO | | VX-52-3A3 | - | VX-012-3A3 | - |
| | Quick Connect Terminal (#187) | SPDT | | VX-52-1C23 | - | VX-012-1C23 | - |
| | | SPST-NC | | VX-52-2C23 | - | VX-012-2C23 | - |
| | | SPST-NO | | VX-52-3C23 | - | VX-012-3C23 | - |
| Long hinge lever  | Solder terminals | SPDT | 0.20 N {20 gf} | VX-53-1A3 | VX-53K-1A3 | VX-013-1A3 | VX-013K-1A3 |
| | | SPST-NC | | VX-53-2A3 | VX-53K-2A3 | VX-013-2A3 | VX-013K-2A3 |
| | | SPST-NO | | VX-53-3A3 | VX-53K-3A3 | VX-013-3A3 | VX-013K-3A3 |
| | Quick Connect Terminal (#187) | SPDT | | VX-53-1C23 | VX-53K-1C23 | VX-013-1C23 | VX-013K-1C23 |
| | | SPST-NC | | VX-53-2C23 | VX-53K-2C23 | VX-013-2C23 | VX-013K-2C23 |
| | | SPST-NO | | VX-53-3C23 | VX-53K-3C23 | VX-013-3C23 | VX-013K-3C23 |
| Simulated roller lever  | Solder terminals | SPDT | 0.29 N {30 gf} | VX-54-1A3 | VX-54K-1A3 | VX-014-1A3 | VX-014K-1A3 |
| | | SPST-NC | | VX-54-2A3 | VX-54K-2A3 | VX-014-2A3 | VX-014K-2A3 |
| | | SPST-NO | | VX-54-3A3 | VX-54K-3A3 | VX-014-3A3 | VX-014K-3A3 |
| | Quick Connect Terminal (#187) | SPDT | | VX-54-1C23 | VX-54K-1C23 | VX-014-1C23 | VX-014K-1C23 |
| | | SPST-NC | | VX-54-2C23 | VX-54K-2C23 | VX-014-2C23 | VX-014K-2C23 |
| | | SPST-NO | | VX-54-3C23 | VX-54K-3C23 | VX-014-3C23 | VX-014K-3C23 |
| Short hinge roller lever  | Solder terminals | SPDT | 0.59 N {60 gf} | VX-55-1A3 | - | VX-015-1A3 | - |
| | | SPST-NC | | VX-55-2A3 | - | VX-015-2A3 | - |
| | | SPST-NO | | VX-55-3A3 | - | VX-015-3A3 | - |
| | Quick Connect Terminal (#187) | SPDT | | VX-55-1C23 | - | VX-015-1C23 | - |
| | | SPST-NC | | VX-55-2C23 | - | VX-015-2C23 | - |
| | | SPST-NO | | VX-55-3C23 | - | VX-015-3C23 | - |
| Hinge roller lever  | Solder terminals | SPDT | 0.29 N {30 gf} | VX-56-1A3 | VX-56K-1A3 | VX-016-1A3 | VX-016K-1A3 |
| | | SPST-NC | | VX-56-2A3 | VX-56K-2A3 | VX-016-2A3 | VX-016K-2A3 |
| | | SPST-NO | | VX-56-3A3 | VX-56K-3A3 | VX-016-3A3 | VX-016K-3A3 |
| | Quick Connect Terminal (#187) | SPDT | | VX-56-1C23 | VX-56K-1C23 | VX-016-1C23 | VX-016K-1C23 |
| | | SPST-NC | | VX-56-2C23 | VX-56K-2C23 | VX-016-2C23 | VX-016K-2C23 |
| | | SPST-NO | | VX-56-3C23 | VX-56K-3C23 | VX-016-3C23 | VX-016K-3C23 |

Contact Form

●SPDT

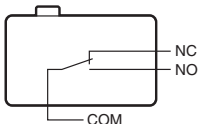

●SPST-NC

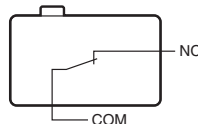

●SPST-NO

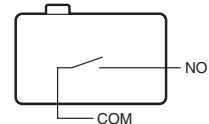

Separator (Sold Separately), Actuator (Sold Separately), Terminal Connector (Sold Separately) ➔ Refer to "Basic Switch Common Accessories"

Contact Specifications

| Item | Model | VX-5 models | VX-01 models |
|---|----------------------|--------------|--------------|
| Contact | Specification | Rivet | Crossbar |
| | Material | Silver alloy | Gold alloy |
| | Gap (standard value) | 0.5 mm | |
| Inrush current | NC | 15 A max. | - |
| | NO | 15 A max. | - |
| Minimum applicable load (reference value) * | | 5 VDC 160 mA | 5 VDC 1 mA |

* Please refer to "Using Micro Loads" in "●Precautions" for more information on the minimum applicable load.

Ratings

| Model | Rated voltage | Item | Resistive load |
|--------------|---------------|------|----------------|
| VX-5 models | 250 VAC | | 5 A |
| | 125 VAC | | 0.1 A |
| VX-01 models | 30 VDC | | 0.1 A |

Note. The above rating values apply under the following test conditions.

- (1) Ambient temperature: 20±2°C
- (2) Ambient humidity: 65±5%
- (3) Operating frequency: 30 operations/min

Approved Safety Standards

UL (UL1054)/CSA (CSA C22.2 No.55)

| Rated voltage | Model | VX-5 | VX-01 |
|------------------|-------|------|-------|
| 125 VAC 250 V | | 5 A | 0.1 A |
| | | 5 A | - |
| 30 VDC | | - | 0.1 A |

VDE (EN61058-1)

| Rated voltage | Model | VX-5 | VX-01 |
|---------------|-------|------|-------|
| 250VAC | | 5 A | - |
| 125VAC | | 5 A | 0.1 A |

Testing conditions: 5E4 (50,000 operations) T105 (0 to 105°C)

Terminals/Appearances (Unit: mm)

| Solder terminals | Quick Connect Terminal (#187) |
|--|--|
| <p>3-Solder terminals</p> | <p>3-Quick Connect Terminal (#187)</p> |
| <p>* This indicates the length to the center of 1.6 dia. hole.</p> | <p>1.6 dia. terminal holes</p> |

Note. The above is for the SPDT contact specifications.

Characteristics

| Item | Model | VX-5 models | VX-01 models |
|---|--|--|--|
| Permissible operating speed | | 0.1 mm to 1 m/s (for pin plunger models) | |
| Permissible operating frequency | Mechanical | 600 operations/min (for pin plunger models) | |
| | Electrical | 60 operations/min | |
| Insulation resistance | | 100 MΩ min. (at 500 VDC with insulation tester) | |
| Contact resistance (initial value) | | 30 mΩ max. | 50 mΩ max. |
| Dielectric strength *1 | Between terminals of the same polarity | 1,000 VAC 50/60 Hz for 1 min | |
| | Between current-carrying metal parts and ground | 1,500 VAC 50/60 Hz for 1 min | |
| | Between terminals and non-current-carrying metal parts | 1,500 VAC 50/60 Hz for 1 min | |
| Vibration resistance *2 | Malfunition | 10 to 55 Hz, 1.5 mm double amplitude | |
| Shock resistance | Durability | 400 m/s ² {approx. 40G} max. | |
| | Malfunition *2 | 100 m/s ² {approx. 10G} max. | |
| Durability *3 | Mechanical | 50,000,000 operations min. (60 operations/min) | 10,000,000 operations min. (60 operations/min) |
| | Electrical | 500,000 operations min. (30 operations/min) | 1,000,000 operations min. (30 operations/min) |
| Degree of protection | | IEC IP40 | |
| Degree of protection against electric shock | | Class I | |
| Proof tracking index (PTI) | | 175 | |
| Ambient operating temperature | | -25 to 105°C (at ambient humidity of 60% max.) (with no icing or condensation) | |
| Ambient operating humidity | | 85% max. (for 5 to 35°C) | |
| Weight | | Approx. 6.2 g (pin plunger models) | |

Note. The data given above are initial values.

- *1. The values for dielectric strength shown are for models with a Separator (refer to "Micro Switch Common Accessories").
- *2. For the pin plunger models, the above values apply for use at the free position and total travel position. For the lever models, they apply at the total travel position. Close or open circuit of the contact is 1 ms max.
- *3. For testing conditions, consult your OMRON sales representative.

Mounting Holes (Unit: mm)

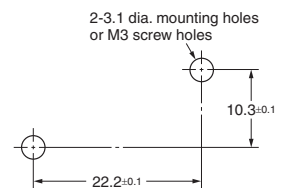

Dimensions (Unit: mm) and Operating Characteristics

The following illustrations and drawings are for solder terminals. Illustrations for Quick Connect Terminal (#187) are omitted. For details, refer to "Terminals/Appearances" on previous page.
The □ is replaced with the code for the terminals. See the "List of Models" for available combinations of shapes.

●Pin plunger

VX-5-1□2

VX-5-1□3

VX-01-1□2

VX-01-1□3

V
X

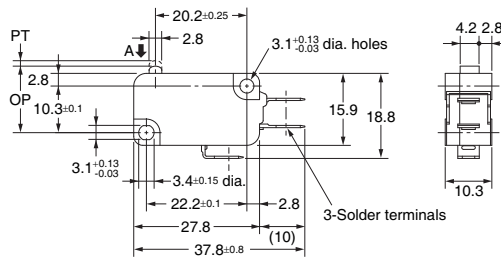
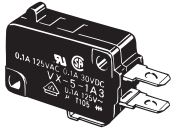

| Operating Characteristics | | Model | VX-5-1□2 | VX-5-1□3 |
|---------------------------|---------|-------|----------------|----------------|
| Operating Force | OF Max. | | 0.25 N {25 gf} | 0.49 N {50 gf} |
| Releasing Force | RF Min. | | 0.03 N {3 gf} | 0.05 N {5 gf} |
| Pretravel | PT Max. | | 1.2 mm | |
| Overtravel | OT Min. | | 1.0 mm | |
| Movement Differential | MD Max. | | 0.3 mm | |
| Operating Position | OP | | 14.7±0.4 mm | |

●Short hinge lever (Standard Position)

VX-51-1□3

VX-011-1□3

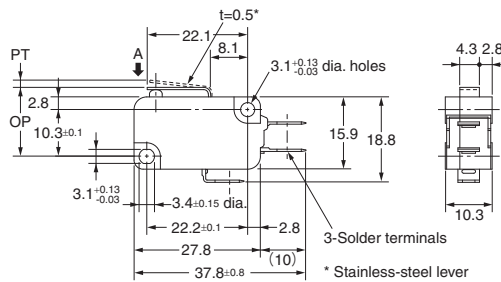
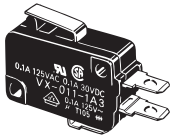

| Operating Characteristics | | Model | VX-51-1□3 | VX-011-1□3 |
|---------------------------|---------|-------|---------------------------------|------------|
| Operating Force | OF Max. | | 0.49 N {50 gf} | |
| Releasing Force | RF Min. | | 0.04 N {4 gf} (reference value) | |
| Pretravel | PT Max. | | 1.6 mm | |
| Overtravel | OT Min. | | 0.8 mm | |
| Movement Differential | MD Max. | | 0.5 mm | |
| Operating Position | OP | | 15.2±0.5 mm | |

Note. The indicated reference values of RF are for cases where the lever weight is not applied to the plunger.

●Hinge lever (Standard Position)

VX-52-1□3

VX-012-1□3

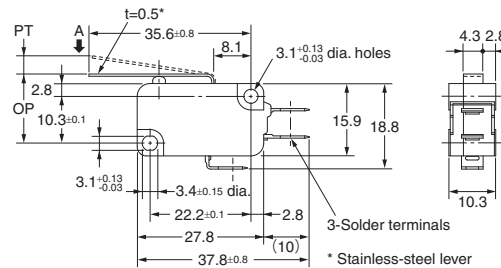
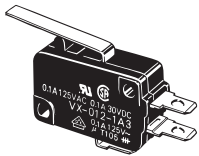

| Operating Characteristics | | Model | VX-52-1□3 | VX-012-1□3 |
|---------------------------|---------|-------|----------------|------------|
| Operating Force | OF Max. | | 0.29 N {30 gf} | |
| Releasing Force | RF Min. | | - | |
| Pretravel | PT Max. | | 4.0 mm | |
| Overtravel | OT Min. | | 1.6 mm | |
| Movement Differential | MD Max. | | 0.8 mm | |
| Operating Position | OP | | 15.2±1.2 mm | |

●Long hinge lever (Standard Position)

VX-53-1□3

VX-013-1□3

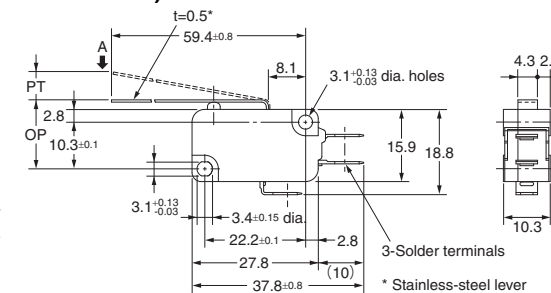
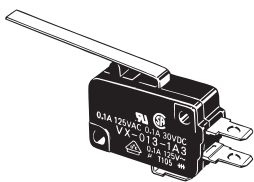

| Operating Characteristics | | Model | VX-53-1□3 | VX-013-1□3 |
|---------------------------|---------|-------|----------------|------------|
| Operating Force | OF Max. | | 0.20 N {20 gf} | |
| Releasing Force | RF Min. | | - | |
| Pretravel | PT Max. | | 9.0 mm | |
| Overtravel | OT Min. | | 3.2 mm | |
| Movement Differential | MD Max. | | 2.0 mm | |
| Operating Position | OP | | 15.2±2.6 mm | |

●Long hinge lever (Position K)

VX-53K-1□3

VX-013K-1□3

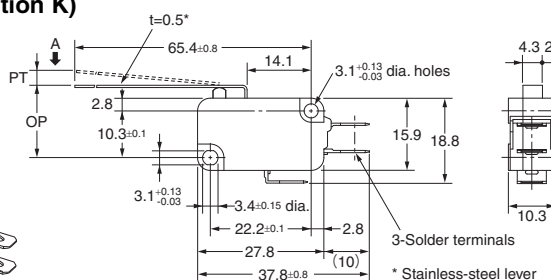
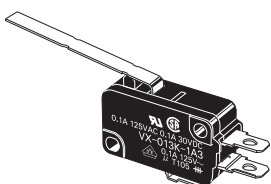

| Operating Characteristics | | Model | VX-53K-1□3 | VX-013K-1□3 |
|---------------------------|---------|-------|----------------|-------------|
| Operating Force | OF Max. | | 0.12 N {12 gf} | |
| Releasing Force | RF Min. | | - | |
| Pretravel | PT Max. | | 15.0 mm | |
| Overtravel | OT Min. | | 5.0 mm | |
| Movement Differential | MD Max. | | 4.2 mm | |
| Operating Position | OP | | 15.2±4.4 mm | |

Note 1. Unless otherwise specified, a tolerance of ±0.4 mm applies to all dimensions.

Note 2. The operating characteristics are for operation in the A direction (↓).

● Simulated roller lever (Standard Position)

VX-54-1□3
VX-014-1□3

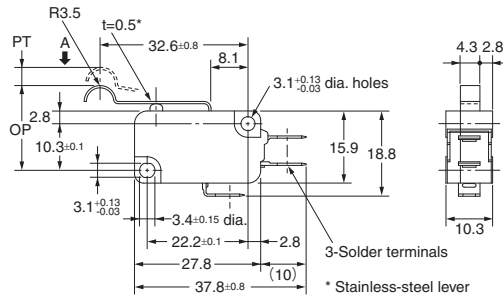
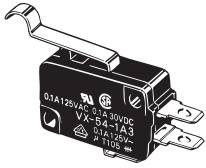

| Operating Characteristics | | Model | VX-54-1□3 VX-014-1□3 |
|---------------------------|----|-------|-------------------------|
| Operating Force | OF | Max. | 0.29 N {30 gf} |
| Releasing Force | RF | Min. | 0.02 N {2 gf} |
| Pretravel | PT | Max. | 4.0 mm |
| Overtravel | OT | Min. | 1.6 mm |
| Movement Differential | MD | Max. | 0.8 mm |
| Operating Position | OP | | 18.7±1.2 mm |

● Simulated roller lever (Position K)

VX-54K-1□3
VX-014K-1□3

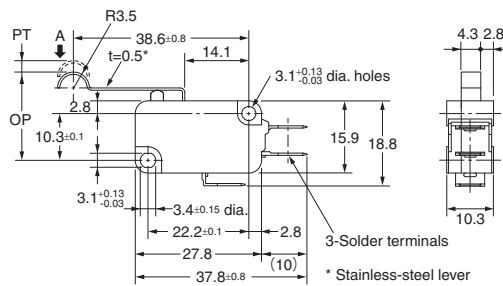
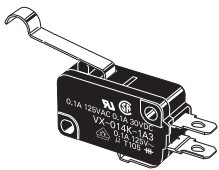

| Operating Characteristics | | Model | VX-54K-1□3 VX-014K-1□3 |
|---------------------------|----|-------|---------------------------|
| Operating Force | OF | Max. | 0.18 N {18 gf} |
| Releasing Force | RF | Min. | (0.01 N {1 gf}) |
| Pretravel | PT | Max. | 7.2 mm |
| Overtravel | OT | Min. | 2.5 mm |
| Movement Differential | MD | Max. | 2.0 mm |
| Operating Position | OP | | 18.7±2.2 mm |

● Short hinge roller lever (Standard Position)

VX-55-1□3
VX-015-1□3

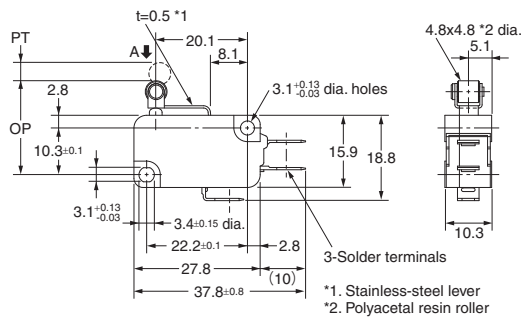
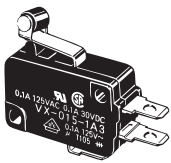

| Operating Characteristics | | Model | VX-55-1□3 VX-015-1□3 |
|---------------------------|----|-------|------------------------------------|
| Operating Force | OF | Max. | 0.59 N {60 gf} |
| Releasing Force | RF | Min. | 0.04 N {4 gf} (reference value) |
| Pretravel | PT | Max. | 1.6 mm |
| Overtravel | OT | Min. | 0.8 mm |
| Movement Differential | MD | Max. | 0.5 mm |
| Operating Position | OP | | 20.7±0.6 mm |

Note. The indicated reference values of RF are for cases where the lever weight is not applied to the plunger.

● Hinge roller lever (Standard Position)

VX-56-1□3
VX-016-1□3

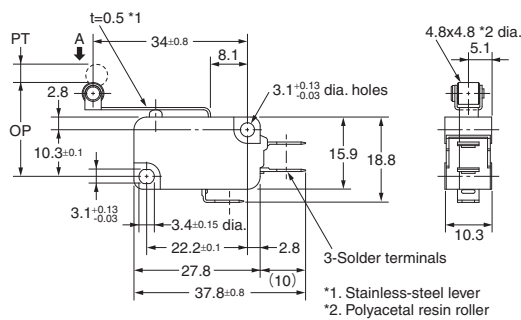
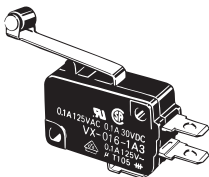

| Operating Characteristics | | Model | VX-56-1□3 VX-016-1□3 |
|---------------------------|----|-------|-------------------------|
| Operating Force | OF | Max. | 0.29 N {30 gf} |
| Releasing Force | RF | Min. | - |
| Pretravel | PT | Max. | 4.0 mm |
| Overtravel | OT | Min. | 1.6 mm |
| Movement Differential | MD | Max. | 0.8 mm |
| Operating Position | OP | | 20.7±1.2 mm |

● Hinge roller lever (Position K)

VX-56K-1□3
VX-016K-1□3

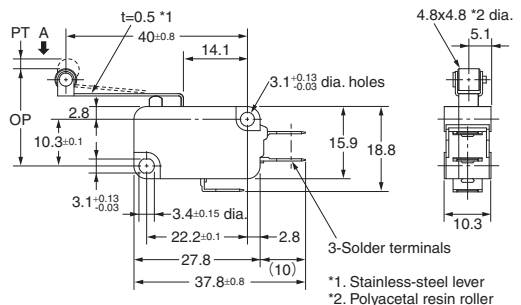
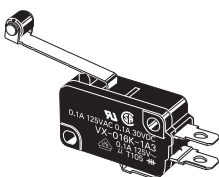

| Operating Characteristics | | Model | VX-56K-1□3 VX-016K-1□3 |
|---------------------------|----|-------|---------------------------|
| Operating Force | OF | Max. | 0.18 N {18 gf} |
| Releasing Force | RF | Min. | (0.01 N {1 gf}) |
| Pretravel | PT | Max. | 7.2 mm |
| Overtravel | OT | Min. | 2.5 mm |
| Movement Differential | MD | Max. | 2.0 mm |
| Operating Position | OP | | 20.7±2.2 mm |

Note 1. Unless otherwise specified, a tolerance of ±0.4 mm applies to all dimensions.
Note 2. The operating characteristics are for operation in the A direction (↓).

Precautions

★Please refer to "Common Precautions" for correct use.

Cautions

●Handling

Do not apply excessive shock. Doing so may cause damage to the Switch's internal components because it is designed for a small load.

●Soldering

• Terminal connections

Complete the soldering at the iron tip temperature between 250 to 350°C (60W) within 5 seconds, and do not apply any external force for 1 minute after soldering.

Apply minimum amount of flux required. It may result in contact failure once the flux penetrates into the internal part of the Switch.

• Connecting to Tab Terminals (#187)

When connecting to the Tab terminal, insert the receptacle of tab #187 straight toward the terminal.

Applying excessive external force laterally may cause deformation of terminals and may damage the housings.

Correct Use

●Mounting

Use M3 mounting screw with plane washers or spring washers to securely mount the Switch. Tighten the screws to a torque of 0.39 to 0.59 N·m {4 to 6 kgf·cm}.

●Mounting Direction

For a Switch with an actuator, mount the Switch in a direction where the actuator weight will not be applied to the Switch. Since the Switch is designed for a small load, its resetting force is small. Therefore, resetting failure may occur if unnecessary load is applied to the Switch.

●Using Micro Loads

Using a model for ordinary loads to open or close the contact of a micro load circuit may result in faulty contact. Use models that operate in the following range. However, even when using micro load models within the following operating range, if inrush current occurs when the contact is opened or closed, it may increase the contact wear and so decrease durability. Therefore, insert a contact protection circuit where necessary. The N-level reference value applies for the minimum applicable load. This value indicates the malfunction reference level for the reliability level of 60% (λ_{60}).

(JIS C5003)

The equation, $\lambda_{60} = 0.5 \times 10^{-6} / \text{operations}$, indicates that the estimated malfunction rate is less than $\frac{1}{2,000,000}$ operations with a reliability level of 60%.

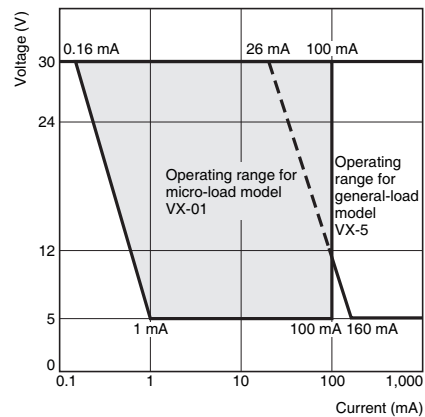

- Application examples provided in this document are for reference only. In actual applications, confirm equipment functions and safety before using the product.
- Consult your OMRON representative before using the product under conditions which are not described in the manual or applying the product to nuclear control systems, railroad systems, aviation systems, vehicles, combustion systems, medical equipment, amusement machines, safety equipment, and other systems or equipment that may have a serious influence on lives and property if used improperly. Make sure that the ratings and performance characteristics of the product provide a margin of safety for the system or equipment, and be sure to provide the system or equipment with double safety mechanisms.

Note: Do not use this document to operate the Unit.

X-ON Electronics

Largest Supplier of Electrical and Electronic Components

Click to view similar products for [Basic / Snap Action Switches](#) category:

Click to view products by [Omron](#) manufacturer:

Other Similar products are found below :

[5SM901-S12](#) [5SM9-S12N195](#) [602EN532](#) [602EN535-RB](#) [602HE5-RB1](#) [604HE162](#) [604HE223-6B](#) [624HE17-RB](#) [6HM82](#) [6HM89](#) [6SE1](#)
[6SX1-H58](#) [70500216](#) [70599106](#) [MBD5B1](#) [MBH2731](#) [73-316-0012](#) [EXD-AR20](#) [79211923](#) [79218589](#) [7AS12](#)
[MIL30126AB6BBMD4A12XAU](#) [ML-1155](#) [ML-1376](#) [831010C3.0](#) [831090C2.EL](#) [83131904](#) [84212012](#) [8AS239](#) [8HM73-3](#) [8SX26-H33](#)
[914CE1-6G](#) [PL-100](#) [11SM1077-H4](#) [11SM1077-H58](#) [11SM1-TN107](#) [11SM405](#) [11SM8423-H2](#) [11SX37-T](#) [11SX48-H58](#) [11SM2442-T](#)
[11SM76-T](#) [11SM77-H58](#) [11SM77-T](#) [11SM863-T](#) [11SM866](#) [A7CN-1M-1-LEFT](#) [A831700C7.0](#) [121EN187-R](#) [121EN188-R](#)