

General-purpose Basic Switch











X









Direct Current Switch with Built-in Magnetic Blowout

- Incorporates a small permanent magnet in the contact mechanism to deflect the arc to effectively extinguish it.
- Ideal for switching DC circuits
- Wide variety of actuators for a wide scope of applications
- Same shape and mounting procedures as Omron's Model Z snap action switches.



Ordering Information

Terminal	Solder terminal 	Screw terminal 
Actuator	Model	Model
Pin plunger 	X-10G	X-10G-B
Slim spring plunger 	X-10GS	X-10GS-B
Short spring plunger 	X-10GD	X-10GD-B
Panel mount plunger 	X-10GQ	X-10GQ-B
Panel mount roller plunger 	X-10GQ22	X-10GQ22-B
Panel mount cross roller plunger 	X-10GQ21	X-10GQ21-B
Leaf spring 	X-10GL	X-10GL-B
Short hinge lever 	X-10GW21	X-10GW21-B

Terminal	Solder terminal 	Screw terminal 
Actuator	Model	Model
Hinge lever 	X-10GW	X-10GW-B
Low-force hinge lever 	X-10GW4	X-10GW4-B
Short hinge roller lever 	X-10GW22	X-10GW22-B
Hinge roller lever 	X-10GW2	X-10GW2-B
Reverse hinge lever 	X-10GM	X-10GM-B
Reverse short hinge roller lever * 	X-10GM22	X-10GM22-B
Reverse hinge roller lever * 	X-10GM2	X-10GM2-B

* The plungers of reverse-type models are continuously pressed by the compression coil springs and the plungers are freed by operating the levers.

Model Number Legend

X - 10 G □ - □
 1 2 3 4

1. Ratings
 10: 10 A (125 VDC)

2. Contact Gap
 G: 0.9 mm

3. Actuator
 None: Pin plunger
 D: Short spring plunger
 S: Slim spring plunger
 Q: Panel mount plunger
 Q21: Panel mount cross roller plunger
 Q22: Panel mount roller plunger
 L: Leaf spring
 W: Hinge lever
 W2: Hinge roller lever
 W21: Short hinge lever
 W22: Short hinge roller lever
 W4: Low-force hinge lever
 M: Reverse hinge lever
 M2: Reverse hinge roller lever
 M22: Reverse short hinge roller lever

4. Terminals
 None: Solder terminal
 B: Screw terminal
 (with toothed washer)

Specifications

■ Characteristics

Operating speed		0.1 mm to 1 m/s (See note 1)
Operating frequency	Mechanical	240 operations/min
	Electrical	20 operations/min
Contact resistance		15 mΩ max. (initial value)
Insulation resistance		100 MΩ min. (at 500 VDC)
Dielectric strength		1,500 VAC, 50/60 Hz for 1 min between terminals of the same polarity, between current-carrying metal parts and the ground, and between each terminal and non-current-carrying metal parts
Vibration resistance	Malfunction	10 to 55 Hz, 1.5-mm double amplitude (See note 2)
Shock resistance	Destruction	1,000 m/s ² max.
	Malfunction	300 m/s ² max. (See notes 1 and 2)
Degree of protection		IP00
Degree of protection against electric shock		Class I
Proof tracking index (PTI)		175
Ambient operating temperature		-25°C to 80°C (with no icing)
Ambient operating humidity		35% to 85%RH
Service life	Mechanical	1,000,000 operations min.
	Electrical	100,000 operations min.
Weight		Approx. 27 to 63 g

- Note: 1. The values are for the pin plunger models.
 2. Malfunction: 1 ms max.

■ Ratings

Rated voltage	Non-inductive load (A)				Inductive load (A)			
	Resistive load		Lamp load		Inductive load		Motor load	
	NC	NO	NC	NO	NC	NO	NC	NO
8 VDC	10		3	1.5	10	10	5	2.5
14 VDC	10		3	1.5	10	10	5	2.5
30 VDC	10		3	1.5	10	10	5	2.5
125 VDC	10		3	1.5	7.5	6	5	2.5
250 VDC	3		1.5	0.75	2	1.5	2	1.5

- Note: 1. The above values are for the steady-state current.
 2. Inductive load has a power factor of 0.4 min. (AC) and a time constant of 7 ms max. (DC).
 3. Lamp load has an inrush current of 10 times the steady-state current.
 4. Motor load has an inrush current of 6 times the steady-state current.
 5. The above electrical ratings also apply to the AC voltage.
 6. With the reverse-type models (X-10GM□), the normally closed circuits and normally open circuits are reversed.
 7. The ratings values apply under the following test conditions:
 (1) Ambient temperature: 20±2°C
 (2) Ambient humidity: 65±5%RH
 (3) Operating frequency: 20 operations/min

■ Contact Specification

Contacts	Material	Silver
	Gap (standard value)	0.9 mm
Inrush current	NC	30 A max.
	NO	15 A max.

■ Safety Standards Ratings

UL/CSA

Rated voltage	X-10G
125 VDC	10 A
250 VDC	3 A

EN (CE) (Conform to EN61058-1)

Rated voltage	X-10
125 VDC	10 A

Engineering Data

Mechanical Durability (X-10G)

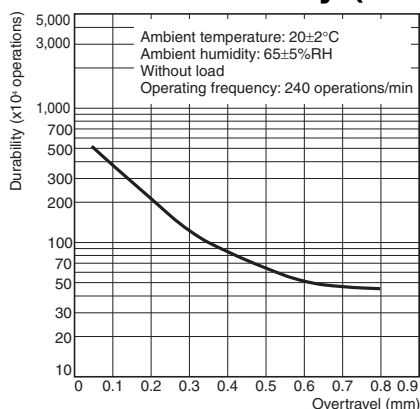

Electrical Durability (X-10G)

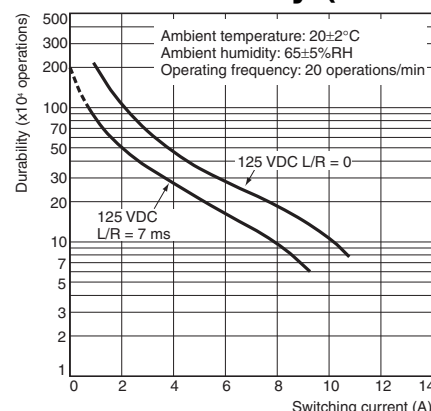

Structure

Contact Form (SPDT)

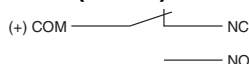

Note: With the reverse-type models (X-10GM□), the NC and NO terminal arrangements are reversed.

Dimensions

Note: Unless otherwise specified, all units are in millimeters and a tolerance of ± 0.4 mm applies to all dimensions.

Terminals

Screw Terminals (-B)

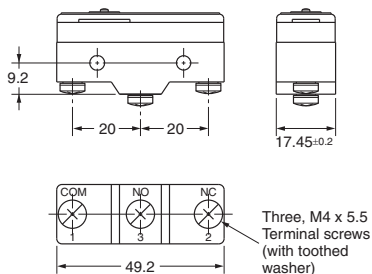

- Note:** 1. Appropriate terminal screw tightening torque: 0.78 to 1.18 N·m.
- 2. In case of DC voltage, set the COM to the positive terminal.

Solder Terminal (Blank)

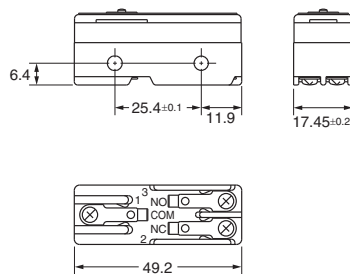

Mounting

All switches can be mounted using M4 mounting screws with plane washers or spring washers to securely mount the Switch. Tighten the screws to a torque of 1.18 to 1.47 N·m.

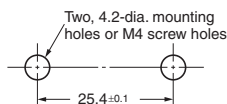

Versions with panel mount plungers can be panel mounted via the plunger, provided that the hexagonal nut of the actuator is tightened to a torque of 2.94 to 4.9 N·m.

Panel Mount Plunger	Panel Mount Roller Plunger
<p>12.5^{+0.2} dia.</p>	<p>12.5^{+0.2} dia. 5^{+0.2}</p>

Note: Mount using either the side mounting holes or the panel mount plunger, not both. If using the side mounting holes, then remove the hexagonal nut(s) from the panel mount plunger.

Accessories (Terminal Covers, Actuators, and Separators): Refer to 'Z/A/X/DZ Common Accessories' datasheet

Note: 1. All drawings show the switches with screw terminals. For solder terminals, remove the “-B” from the end of the part number
 2. Unless otherwise specified, all units are in millimeters and a tolerance of ± 0.4 mm applies to all dimensions.

Pin Plunger
X-10G-B

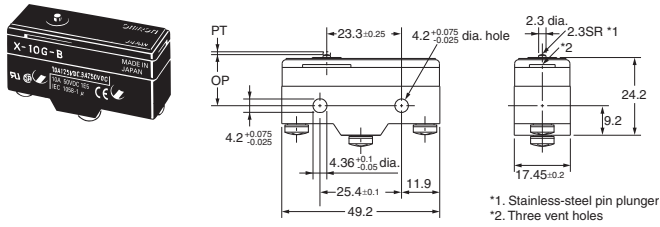

Slim Spring Plunger
X-10GS-B

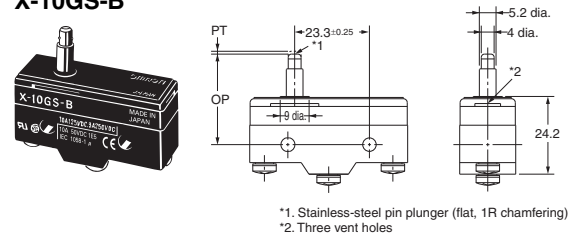

Short Spring Plunger
X-10GD-B

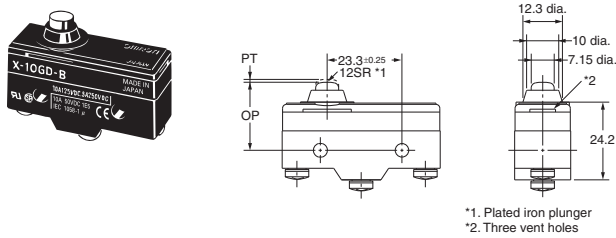

Panel Mount Plunger
X-10GQ-B

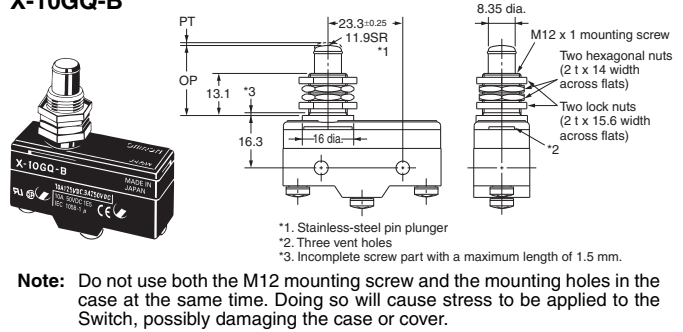

Panel Mount Roller Plunger
X-10GQ22-B

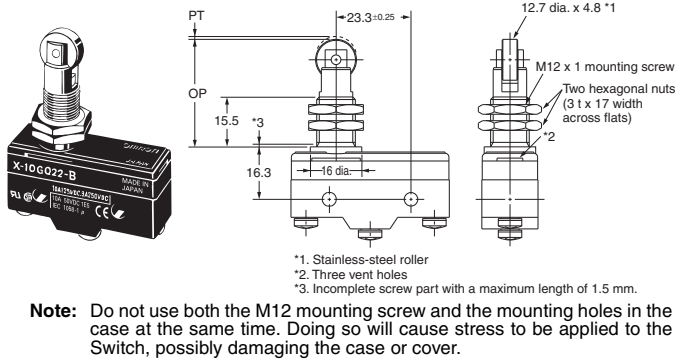

Panel Mount Cross Roller Plunger
X-10GQ21-B

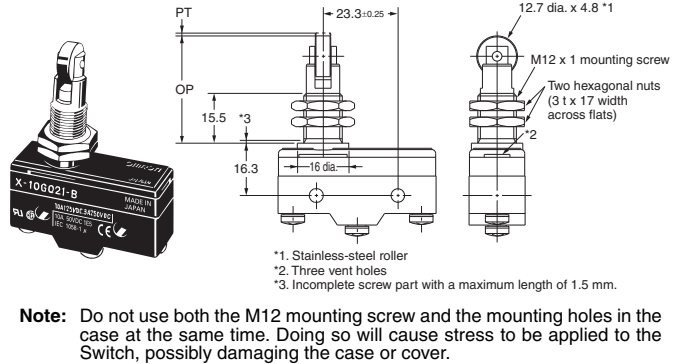

Leaf Spring
X-10GL-B

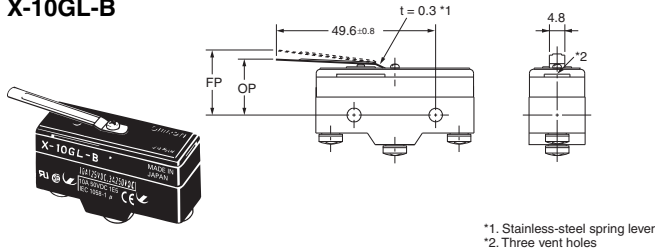

Operating Characteristics	X-10G-B	X-10GS-B	X-10GD-B	X-10GQ-B	X-10GQ22-B	X-10GQ21-B	X-10GL-B
OF max.	510 gf	510 gf	510 gf	510 gf	510 gf	510 gf	200 gf
RF min.	114 gf	114 gf	114 gf	114 gf	114 gf	114 gf	14 gf
PT max.	0.9 mm	0.9 mm	0.9 mm	0.9 mm	0.9 mm	0.9 mm	-
OT min.	0.13 mm	1.6 mm	1.6 mm	5.5 mm	3.6 mm	3.6 mm	1.6 mm *
MD max.	0.18 mm	0.18 mm	0.18 mm	0.18 mm	0.18 mm	0.18 mm	2.3 mm
FP max.	-	-	-	-	-	-	22.1 mm
OP	15.9±0.4 mm	28.2±0.5 mm	21.2±0.5 mm	21.8±0.8 mm	33.4±1.2 mm	33.4±1.2 mm	17.4±0.8 mm

* Be sure to use the switch at the rated OT value of 1.6 mm.

Note: 1. All drawings show the switches with screw terminals. For solder terminals, remove the “-B” from the end of the part number
 2. Unless otherwise specified, all units are in millimeters and a tolerance of ± 0.4 mm applies to all dimensions.

Short Hinge Lever

X-10GW21-B

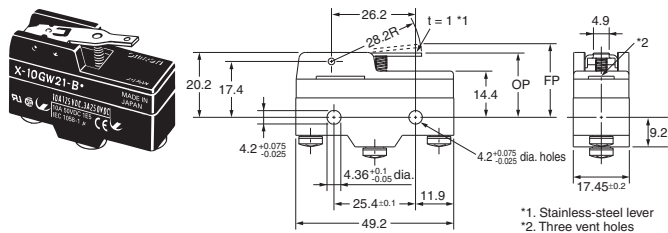

Hinge Lever

X-10GW-B

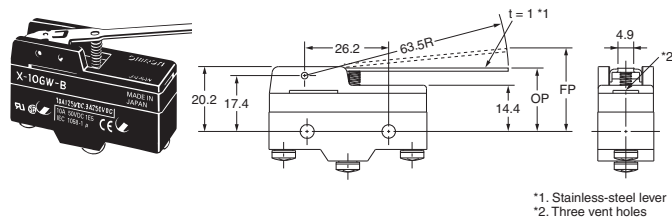

Low-force Hinge Lever

X-10GW4-B

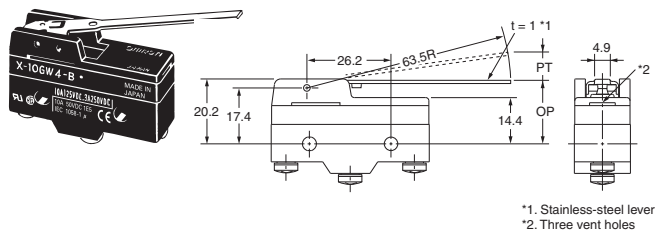

Short Hinge Roller Lever

X-10GW22-B

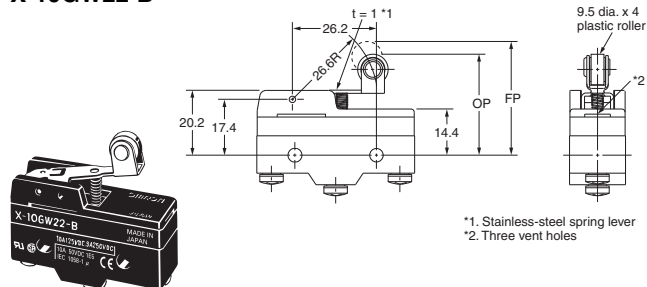

Hinge Roller Lever

X-10GW2-B

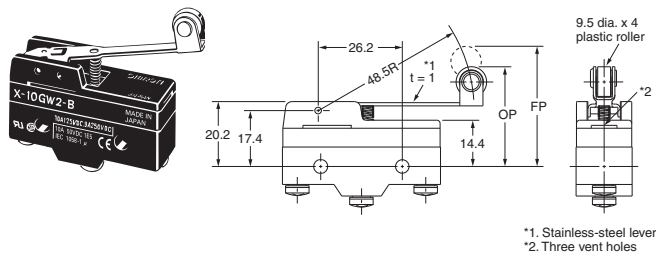

Reverse Hinge Lever

X-10GM-B

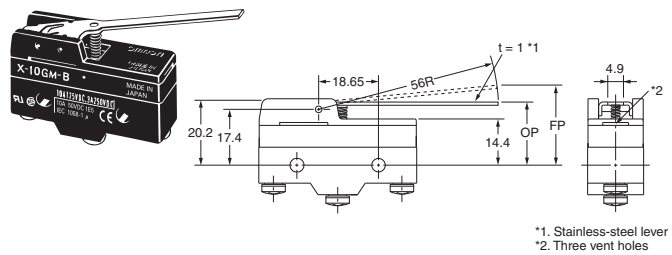

Reverse Short Hinge Lever

X-10GM22-B

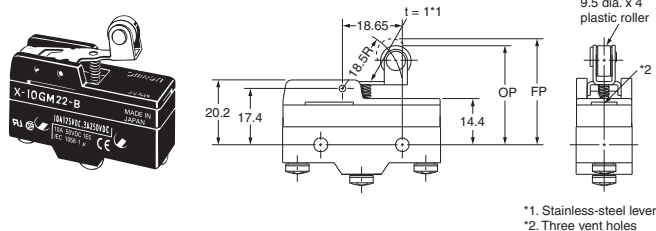

Reverse Hinge Roller Lever

X-10GM2-B

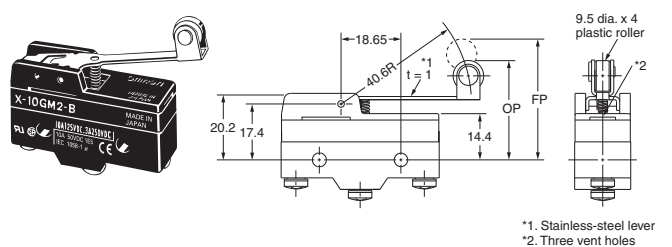

Operating Characteristics	X-10GW21-B	X-10GW-B	X-10GW4-B	X-10GW22-B	X-10GW2-B	X-10GM-B	X-10GM22-B	X-10GM2-B
OF max.	250 gf	110 gf	25 gf	220 gf	145 gf	220 gf	700 gf	320 gf
RF min.	32 gf	14 gf	5 gf	35 gf	21 gf	25 gf	155 gf	50 gf
PT max.	-	-	14.3 mm	-	-	-	-	-
OT min.	2.1 mm	4.8 mm	4.8 mm	2.4 mm	4 mm	5.5 mm	2 mm	4 mm
MD max.	1.7 mm	3.9 mm	3.9 mm	1.7 mm	3 mm	2.1 mm	0.75 mm	1.5 mm
FP max.	25.5 mm	34.6 mm	-	37.1 mm	40.5 mm	26.8 mm	36.1 mm	37.4 mm
OP	20.7±0.8 mm	21.1±0.8 mm	21.1±0.8 mm	32.2±0.8 mm	32.2±0.8 mm	21.1±0.8 mm	32.2±0.8 mm	32.2±0.8 mm

Safety Precautions

Be sure to read the precautions and information common to all Snap Action and Detection Switches, contained in the Technical User's Guide, "Snap Action Switches, Technical Information" for correct use.

Precautions for Safe Use

Terminal Connection

When soldering lead wires to the Switch, make sure that the capacity of the soldering iron is 60 W maximum. Do not take more than 5 s to solder any part of the Switch. The characteristics of the Switch will deteriorate if a soldering iron with a capacity of more than 60 W is applied to any part of the Switch for 5 s or more.

Operation

- Make sure that the switching frequency or speed is within the specified range.

- If the switching speed is extremely slow, the contact may not be switched smoothly, which may result in a contact failure or contact welding.
- If the switching speed is extremely fast, switching shock may damage the Switch soon. If the switching frequency is too high, the contact may not catch up with the speed.

The rated permissible switching speed and frequency indicate the switching reliability of the Switch.

The life of a Switch is determined at the specified switching speed. The life varies with the switching speed and frequency even when they are within the permissible ranges. In order to determine the life of a Switch model to be applied to a particular use, it is best to conduct an appropriate durability test on some samples of the model under actual conditions.

- Make sure that the actuator travel does not exceed the permissible OT position. The operating stroke must be set to 70% to 100% of the rated OT.

Precautions for Correct Use

Mounting Location

- Do not use the switch alone in atmospheres such as flammable or explosive gases. Arcing and heat generation associated with switching may cause fires or explosions.
- Switches are generally not constructed with resistance against water. Use a protective cover to prevent direct spraying if the switch is used in locations subject to splashing or spurting oil or water, dust adhering.

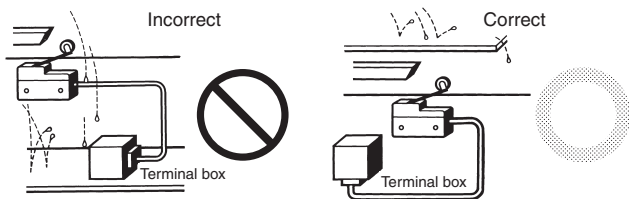

- Install the switch in a location that is not directly subject to debris and dust from cutting. The actuator and the switch body must be protected from accumulated cutting debris and dirt.

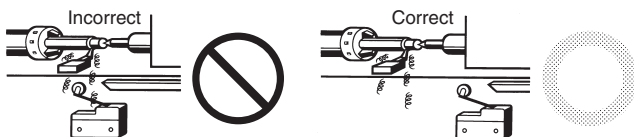

- Do not use the switch in locations subject to hot water (greater than 60°C) or in water vapor.

- Do not use the switch outside the specified temperature and atmospheric conditions.

The permissible ambient temperature depends on the model. (Refer to the specifications in this catalog.) Sudden thermal changes may cause thermal shock to distort the switch and result in faults.

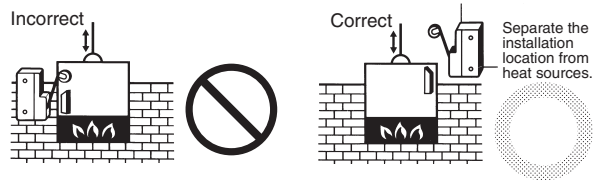

- Mount a cover if the switch is to be installed in a location where worker inattention could result in incorrect operation or accidents.



- Subjecting the switch to continuous vibration or shock may result in contact failure, faulty operation or reduced service life due to abrasion powder. Excessive vibration or shock will cause the contacts to operate malfunction or become damaged. Mount the switch in a location that is not subject to vibration or shock and in a direction that does not subject the switch to resonance.

- If silver contacts are used with relatively low frequency for a long time or are used with microloads, the sulfide coating produced on the contact surface will not be broken down and contact faults will result. Use a microload switch that uses gold contacts.

- Do not use the switch in atmospheres with high humidity or heat or in harmful gases, such as sulfide gas (H₂S, SO₂), ammonia gas (NH₃), nitric acid gas (HNO₃), or chlorine gas (Cl₂). Doing so may impair functionality, such as with damage due to contacting faults or corrosion.

- The switch includes contacts. If the switch is used in an atmosphere with silicon gas, arc energy may cause silicon oxide (SiO₂) to accumulate on the contacts and result in contact failure. If there is silicon oil, silicon filling, silicon wiring, or other silicon products in the vicinity of the switch, use a contact protection circuit to limit arcing and remove the source of the silicon gas.

Handling

- Set the common (COM) terminal to the positive terminal. If it is set to the negative terminal, the Switch will not turn OFF.

- When using the Switch under an inductive load, the arc suppression capability varies depending on current. If the current becomes 0.6 to 1.2 A or if the time constant L/R exceeds 7 ms, be sure to provide an arc suppressor.

- Since the Switch incorporates a permanent magnet, attention must be paid to the following points:

- Avoid mounting the Switch directly onto a magnetic substance.
- Do not subject the Switch to severe shocks.
- Avoid placing the Switch in a strong magnetic field.
- Be sure to prevent iron dust or iron chips from adhering to the built-in magnet or the magnetic blowout function of the Switch will be adversely affected.
- Do not apply thermal shock to the Switch, or the magnetic flux will be diminished.

- Since a ventilation hole is provided to avoid abnormal corrosion due to operating conditions, provide a dustproofing device in locations where the Switch is exposed to dust.

- Do not change operating positions for the actuator. Changing the position may cause malfunction.

Panel-mounted Model (X-10G□)

- To side-mount the panel-mount Switch to the panel with screws, remove the hexagonal nut from the actuator.

- Too large a dog angle and too fast operating speed may damage the Switch when the Switch is side-mounted on the panel.

- Too fast operating speed and too long overtravel of the roller plunger Switch may result in damage to the Switch.

A large grid of 20 columns and 30 rows of small squares, intended for writing notes or technical specifications. The grid is composed of thin lines forming a uniform pattern of squares across the page.

All sales are subject to Omron Electronic Components LLC standard terms and conditions of sale, which can be found at http://www.components.omron.com/components/web/webfiles.nsf/sales_terms.html

ALL DIMENSIONS SHOWN ARE IN MILLIMETERS.
To convert millimeters into inches, multiply by 0.03937. To convert grams into ounces, multiply by 0.03527.

OMRON[®]

**OMRON ELECTRONIC
COMPONENTS LLC**

55 E. Commerce Drive, Suite B
Schaumburg, IL 60173

847-882-2288

OMRON ON-LINE

Global - <http://www.omron.com>

USA - <http://www.components.omron.com>

X-ON Electronics

Largest Supplier of Electrical and Electronic Components

Click to view similar products for [Basic / Snap Action Switches](#) category:

Click to view products by [Omron](#) manufacturer:

Other Similar products are found below :

[5SM901-S12](#) [5SM9-S12N195](#) [602EN532](#) [602EN535-RB](#) [602HE5-RB1](#) [604HE162](#) [604HE223-6B](#) [624HE17-RB](#) [6HM82](#) [6HM89](#) [6SE1](#)
[6SX1-H58](#) [70500216](#) [70599106](#) [MBD5B1](#) [MBH2731](#) [73-316-0012](#) [EXD-AR20](#) [79211923](#) [79218589](#) [7AS12](#)
[MIL30126AB6BBMD4A12XAU](#) [ML-1155](#) [ML-1376](#) [831010C3.0](#) [831090C2.EL](#) [83131904](#) [84212012](#) [8AS239](#) [8HM73-3](#) [8SX26-H33](#)
[914CE1-6G](#) [PL-100](#) [11SM1077-H4](#) [11SM1077-H58](#) [11SM1-TN107](#) [11SM405](#) [11SM8423-H2](#) [11SX37-T](#) [11SX48-H58](#) [11SM2442-T](#)
[11SM76-T](#) [11SM77-H58](#) [11SM77-T](#) [11SM863-T](#) [11SM866](#) [A7CN-1M-1-LEFT](#) [A831700C7.0](#) [121EN187-R](#) [121EN188-R](#)